

ULTRAPROBE® 9000

Instruction Manual

Safety advisory

Please read before using your instrument.

Warning

Improper use of your ultrasonic detector may result in death or serious injury. Observe all safety precautions. Do not attempt to make any repairs or adjustments while the equipment is operating. Be sure to turn off and LOCK OUT all electrical and mechanical sources before performing any corrective maintenance. Always refer to local guidelines for appropriate lockout and maintenance procedures.

SAFETY PRECAUTION:

Although your ultrasonic instrument is intended to be used while equipment is operating, the close proximity of hot piping, electrical equipment and rotating parts are all potentially hazardous to the user. Be sure to use extreme caution when using your instrument around energized equipment. Avoid direct contact with hot pipes or parts, any moving parts or electrical connections. Do not attempt to check findings by touching the equipment with your hands or fingers. Be sure to use appropriate lockout procedures when attempting repairs.

Be careful with loose hanging parts such as the wrist strap or headphone cord when inspecting near moving mechanical devices since they may get caught. Don't touch moving parts with the contact probe. This may not only damage the part, but cause personal injury as well.

When inspecting electrical equipment, use caution. High voltage equipment can cause death or severe injury. Do not touch live electrical equipment with your instrument. Use the rubber focusing probe with the scanning module. Consult with your safety director before entering the area and follow all safety procedures. In high voltage areas, keep the instrument close to your body by keeping your elbows bent. Use recommended protective clothing. Do not get close to equipment. Your detector will locate problems at a distance.

When working around high temperature piping, use caution. Use protective clothing and do not attempt to touch any piping or equipment while it is hot. Consult with your safety director before entering the area.

Version 2	3
Basic Components UP9000	7
Plug-in Modules.....	8
Trisonic™ Scanning module.....	8
Stethoscope (contact) Module.....	8
Pistol-grip Housing	8
Trigger on/off Trigger Switch	9
I/O PORT:.....	9
Battery Compartment	9
Battery.....	9
Wrist Strap.....	9
Sensitivity control.....	9
Storage entry button.....	9
Head set jack	9
Recharge jack	9
Standard Accessories.....	10
Headset	10
WTG-1 Warbletone generator	10
Rubber focusing probe	10
Stethoscope Extension kit	10
4PC-USB I/O Cable.....	10
BCH-92/102 BATTERY CHARGER:	10
Optional Accessories	11
LRM-9:	11
CFM-9:	11
UWC-9000:	11
DHC 1991 ear piece	11
SA-2000 Speaker amplifier	11
UFMTG-1991:	11
WTG-2SP Warble pipe threaded tone generator.....	11
BP-9	11
BPA-9	11
HTS-2	11
Sheath.....	11
LLA	11
DISPLAY PANEL:	11
BARGRAPH DISPLAY:	12
To adjust the sensitivity / volume:	12
To adjust the frequenc	12

Yellow store button	12
To store data	13
To overwrite data or to enter data in a new location	13
To return to the operation mode	13
To download the information	13
Text editor	13
SETUP MODE	14
Data Transfer	14
Set Time and Date	14
dB Scale Select	15
dB Offset	15
Display Mode	16
Calibration Due Date	16
Text Editor	17
Date Format	17
Factory Defaults	17
Exit to program	18
USERS INSTRUCTIONS	18
Trisonic Scanning module	18
Method of airborne detection	19
Headset	19
Rubber focusing probe	19
Stethoscope module	19
Stethoscope extension kit	19
To charge the UP9000	19
Warble tone generator (UE-WTG-1)	20
To charge the warble tone generator	20
Helpful hints	20
Auto-shutdown battery feature	20
Resetting the on board computer	21
Applications	21
Leak Detection	22
How to locate leaks	22
To confirm a leak	23
Overcoming difficulties	23
Shielding techniques	23
Low level leaks	24
Tone test (Ultratone)	24

- Do not use the Tone test in a complete vacuum. 25
- Transformers, switchgear another electrical apparatus 25
 - Electric arc, Corona, Tracking Detection 26
 - Monitoring bearing wear 27
 - Detecting bearing failure..... 28
 - Lack of Lubrication: 28
 - Over Lubrication: 29
 - To avoid over lubrication: 29
 - Slow speed bearings..... 29
 - FFT Interface..... 29
 - General mechanical trouble shooting 29
 - Monitoring operating equipment 30
 - faulty steam traps locating 30
 - Frequency selection 31
 - General steam/condensate/flash steam confirmation..... 31
 - Inverted bucket traps 31
 - A float and thermostatic 32
 - Thermodynamic (Disc)..... 32
 - Thermostatic traps (bellows & bi-metallic) 32
 - Locating faulty valves 32
 - Procedure for valve check 33
 - ABCD Method..... 33
 - Confirming valve leakage in noisy pipe systems 34
- Miscellaneous problem areas 34
 - Underground leaks 34
 - Leakage behind walls 34
 - Partial blockage 35
 - Flow direction..... 35
- Ultrasound technology..... 35
 - Instructions for setting combination on carrying case..... 36
- Ultraprobe® 9000 Specifications..... 38
- Annex A 39

Welcome to the wonderful world of airborne ultrasound inspection

Congratulations, you are about to experience the ultimate in airborne/structure borne ultrasonic inspection. Your Ultraprobe 9000 is equipped with features that will help you inspect in the most challenging environment.

Overview

Your Ultraprobe 9000 is a versatile instrument with many features that will make your inspections easy, fast and accurate. As with any new instrument, it is important to review this manual before you begin inspections. While simple to use as a basic inspection tool, there are many powerful features that when understood, will open up a world of opportunities for inspection and data analysis.

Ultrasound Technology Instruction Scholarship Certificate

Your Ultraprobe 9000 has many applications ranging from leak detection to mechanical inspection and may be used to trend, analyze or just find a problem. How it is used is up to you. As you gain knowledge and learn how many modes of inspection you can cover, you might want to extend your knowledge by enrolling in one of the many training courses offered by UE Training Systems, Inc. certificate is available to you. Simply fill out the form found at the end of this manual and mail or fax it in. The Ultraprobe 9000 is an ultrasonic inspection information, storage and retrieval system in a pistol housing. There are two modes that are important to understand:

Operation Mode

The operation mode will be described in detail under the operation mode section. In this mode you will perform all inspection actions such as scanning, probing, "Click and Spin" activities, and store data. NOTE: "Click" operations require pressing a dial. "Spin" operations require turning a dial.

Set up mode

The setup mode will be described in detail under the Set Up Mode section,. There are 9 menu options that will be described in that section.

Basic Components UP9000



Plug-in Modules

Trisonic™ Scanning module



Trisonic™ Scanning Module

This module is utilized to receive air-borne ultrasound such as the ultrasounds emitted by pressure/vacuum leaks and electrical discharges. There are four prongs at the rear of the module. For placement, align the prongs with the four corresponding jacks in the front end of the pistol housing and plug in. The Trisonic™ Scanning Module has a phased array of three piezoelectric transducers to pick up the airborne ultrasound. This phased array focuses the ultrasound on one „hot spot“ for directionality and effectively intensifies the signal so that minute ultrasonic emissions can be detected.

Stethoscope (contact) Module

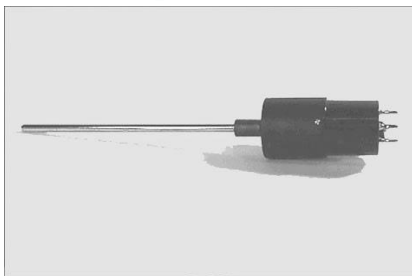

Stethoscope Module

This is the module with the metal rod. This rod is utilized as a „waveguide“ in that it is sensitive to ultrasound that is generated internally such as within a pipe, bearing housing or steam trap. Once stimulated by ultrasound, it transfers the signal to a piezoelectric transducer located directly in the module housing. It is module shielded to provide protection from stray RF waves that have a tendency to effect electronic receiving and measurement. This module can be effectively utilized in practically any environment ranging from airports to broadcasting towers. It is equipped with low noise amplification to allow for a clear, intelligible signal to be received and interpreted. For placement align the four prongs on the back with the corresponding receptacles in the front of the pistol and plug in.

Pistol-grip Housing

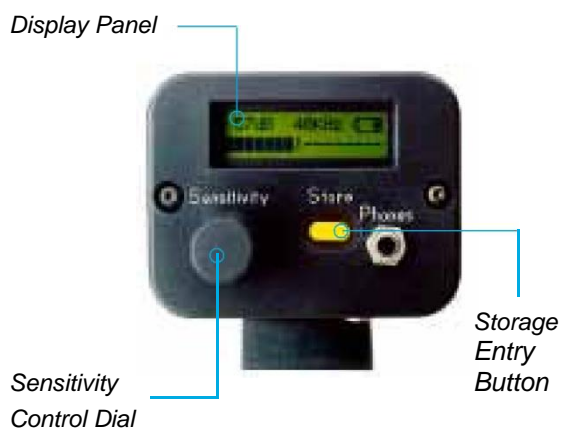

Trigger on/off Trigger Switch

The Ultraprobe is always „off“ until the trigger switch is pressed. To operate, press the trigger. To turn the instrument off, release the trigger.

I/O PORT:

This is the USB port for upload/download information transfer. Align the pins from the cable and plug in. Note: before downloading data, be sure the cable is connected to both the I/O port and to the computer

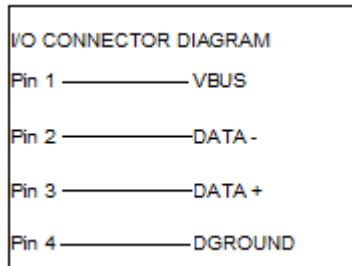

Battery Compartment

The Handle contains the battery. Remove the cover to change batteries.

Battery

The battery is an environmentally friendly nickel metal hydride with no memory problems. A full charge will take 8 hours, however you may charge the unit at any time for short intervals or for a longer period. If it is kept on charge over 8 hours, there will be no harm to the battery.

NOTE: When the effective battery charge is used up the instrument shuts down and a message to recharge the battery will be displayed in the display panel.

Wrist Strap

To protect the instrument, against unexpected droppage use the wrist strap.

Sensitivity control

This is one of the most important controls in the unit. In the operation mode it lets you adjust the sensitivity. When clicked it can change the frequency. In the Set Up Mode it moves the cursor and by clicking sets notations.

Storage entry button

This yellow button is used to store data, and also puts you into the “Text Field Editor” (when enabled).

Head set jack

This is where you plug in the headset. Be sure to plug it in firmly until it clicks.

Recharge jack

This Jack receives the plug from the recharger. The recharger is designed to plug into a standard electrical receptacle.

Standard Accessories

Headset

This heavy-duty headset is designed to block out intense sounds often found in industrial environments so that the user may easily hear the sounds received by the ULTRAPROBE. In fact, the standard headphones provide over 23 dB of noise attenuation.

WTG-1 Warbletone generator (Except the S, C and CS kit)

The WTG-1 Tone Generator is an ultrasonic transmitter designed to flood an area with ultrasound. It is used for a special type of leak test. When placed inside an empty container or on one side of a test item, it will flood that area with an intense ultrasound that will not penetrate any solid but will flow through any existing fault or void. By scanning with the Trisonic™ Scanning Module, empty containers such as pipes, tanks, windows, doors, bulkheads or hatches can be instantly checked for leakage. This Tone Generator is a WARBLE TONE GENERATOR. This internationally patented transmitter sweeps through a number of ultrasonic frequencies in a fraction of a second to produce a strong, recognizable „Warble“ signal. The warble tone prevents a standing wave condition which can produce false readings and provides for a consistency of testing in practically any material.

Rubber focusing probe

The Rubber Focusing Probe is a cone shaped rubber shield. It is used to block out stray ultrasound and to assist in narrowing the field of reception of the “Trisonic“ Scanning Module.

Stethoscope Extension kit

This consists of three metal rods that will enable a user to reach up to 78 cm (31 additional inches) with the Stethoscope Probe.

4PC-USB I/O Cable

I/O cable With Protection Circuitry for downloading records from the UP9000 to the USB port on a PC.

BCH-92/102 BATTERY CHARGER:

This is the standard battery charger for the UP9000 with a line input or “Mains” Of 230VAC @50Hz. (For countries with 220V/50Hz, the BCH-92 is considered a “Standard Accessory”.)

Optional Accessories

LRM-9:

A cone shaped scanning module that increases the detection distance above standard scanning modules. The LRM-9 is ideal for high voltage inspection and for locating leaks at great distances.

CFM-9:

A scanning module used for close proximity leak detection in pressure and vacuum systems.

UWC-9000:

The UWC-9000, Ultrasonic Waveform Concentrator, doubles the detection distance. The UWC-9000 is great for corona, tracking and arc detection at safe distances. Includes carrying case

DHC 1991 ear piece

Ear piece eliminates the need for standard headphones.

SA-2000 Speaker amplifier

The SA-2000 is a loud speaker and amplifier that is compatible with the Ultraprobe headphone output jack.

UFMTG-1991:

The UFMTG 1991 is a multi directional warble tone generator. It has a high power output with a circular transmission pattern of 360°.

WTG-2SP Warble pipe threaded tone generator

A Warble Tone Generator that is used in test conditions where it is not possible to physically place the standard WTG-1 Warble Tone Generator, such as in pipes or in certain heat exchangers or tanks. Features: 1" NPT male threaded nipple with adapters for 3/4" and 1/2" female nipple with a 10 turn amplitude adjustment dial. Metric adapters available.

BP-9

Extended use auxiliary battery pack for use with the UP9000.

BPA-9

Spare battery pack for use with the UP9000.

HTS-2

Holster set for the UP9000. Includes a utility belt and two holsters, one for the UP9000 one module and rubber focusing probe; the other for accessories.

Sheath

The sheath is a cordura cover protector for the UP9000 Pistol Housing.

LLA

Liquid Leak Amplifier case. It holds 12 8 oz. Bottles of Liquid Leak Amplifier (For Ultrasonic Bubble Testing).

DISPLAY PANEL:

When the trigger is pressed to turn the instrument on, the Display Panel will display intensity levels

simultaneously on a bar graph and as a numerical decibel value. The current selected frequency will also be shown. Remaining Battery Charge is shown in the upper right corner. The letters **R**, **S** or **P** will alternate with the battery indicator in the upper right corner. R indicates that the instrument is running in “**Real Time**”, S indicates “**Snap Shot**” and P indicates “**Peak Hold**”. Should the instrument be set in the Offset Mode, then the letters **RO**, **SO** and **PO** will be displayed.

BARGRAPH DISPLAY:

The bar graph has 16 segments. Each segment represents 3 decibels. At the end of the bar graph is a vertical line, which indicates the peak intensity. This is a Peak Hold function. When in operation, the bar graph will move up and down the scale as an indication of the amplitude of a sensed ultrasound. The Peak Hold indicator will remain at the highest sensed intensity during a particular inspection until: 1. A new maximum reading is detected, or 2. The trigger is released and the instrument is turned off. At which time it will reset.

06 dB 40kHz R

06dB 40kHz S

Real Time = R Flashes

Snap Shot = S Flashes

06 dB 40kHz P

Peak Hold = P Flashes

All of these alternate with battery level Indicator

To adjust the sensitivity / volume:

- Look at the meter. If the instrument is within range, the dB decibel indicator must blink. The kHz (frequency), indicator must be steady and not blink.
- If the frequency indicator is blinking, click in the sensitivity control dial until the frequency indicator is steady and the decibel indicator blinks.. This indicates that you are now able to adjust the sensitivity.
- Once in the Sensitivity mode, turn the Sensitivity control dial clockwise to increase the sensitivity and counter clockwise to decrease the sensitivity.
- The Sensitivity control dial increases/decreases the sensitivity of the instrument simultaneously with the sound level in the headphones NOTE: the instrument needs to be in range for accurate testing.
- If the sensitivity is too low, a blinking arrow pointing to the right will appear and there will be no numeric decibel visible in the display panel. If this occurs, increase the sensitivity until the arrow disappears (in low level sound environments the arrow will blink continuously and It will not be possible to achieve a dB indication until a higher intensity level is sensed).
- If the sensitivity is too high, a blinking arrow pointing to the left will appear and there will be no numeric decibel visible on the display panel. Reduce the sensitivity until the arrow disappears and the numeric decibel value is shown.

NOTE: The blinking arrow indicates the direction in which the Sensitivity Control Dial is to be turned.

- The Sensitivity Control Dial controls the bar graph display.
- Each click of the sensitivity dial changes the sensitivity / volume by 1 dB

To adjust the frequenc

- Look at the meter. The kHz indicator must blink to be able to tune the frequency. If it is not blinking, “Click” in the Sensitivity control dial one time and the kHz indicator in the display panel will blink
- When the kHz indicator blinks, change the frequency by rotating the Sensitivity dial up (clockwise) or down (counter clockwise).

Yellow store button

To store a reading:

- “click” / press the yellow Store Button. This puts the instrument in the data storage mode. In the data storage mode the display panel changes.
- The Storage Location is shown in the upper left corner. There are 400 Storage Locations numbered 001 to 400. If the Storage Location has no data in it, the display will show: “NOT USED”.
- If there has been information stored in the selected location, the upper section of the display will indicate that information. The text field (if previously selected), Time, Date, Decibel, Frequency and Operation Mode “R”, “S”, “P” (RO, SO, or PO with offset Value in the Offset Mode) will blink and alternate (scroll). The text field, if previously selected in the Set Up Mode, may be used to record notes or codes.
- The lower left corner of the display indicates the current decibel level selected for storage.
- The lower right of the display indicates the current frequency selected for storage.

001	not used
25dB	40kHz R

Data Storage
Mode Display

- The lower right corner of the display indicates the Operation Mode “R”, “S” or “P”, RO, SO, or PO.

To store data

- Click the Store Button again and the data will be stored and displayed on top.

To overwrite data or to enter data in a new location

- Press the yellow Store button to enter the data storage mode.
- Spin the Sensitivity Dial until the desired storage location is displayed on the screen
- Click the yellow Store Button to store the new information in that location and proceed as described above.

NOTE: When using Ultratrend software it is possible to enter a new reading that is out of sequence by spinning to the last unused memory location (as long as all 400 locations are not filled) and entering the data as described above. Following instructions in Ultratrend, a new sequential order can be updated to include the new item(s) for future inspections.

To return to the operation mode

Click the Sensitivity Control Dial.

To download the information

Refer to Setup Mode, 01 Data Transfer

Text editor

- To enter text in the text field:
- If enabled (refer to SET UP MODE 07), Click the Store Button once after storing data
- The text field will blink. If the field has no entry, it will display “UNKNOWN” and the first character will blink.
- The Sensitivity control dial can be used to scroll through the alphabet, A-Z , a space character and then through numbers 0-9. Spin the Sensitivity dial clockwise to move up the alphabet and then to numbers or counter clockwise to move back through numbers (9-0) and then back down the alphabet (Z-A).
- To enter, click the Sensitivity Control Dial to enter the text character.
- The next location to the right will then blink. Continue until through or until all 8 fields are filled.

- If an error in recording a letter or number occurs, click the Sensitivity Control Dial and the cursor will move to the right. Continue clicking the Sensitivity Control Dial and the cursor will “wrap” around to the right until the desired location is reached. As explained above, spin the Sensitivity Control Dial until the corrected entry is displayed and “click” the Sensitivity Control Dial to enter the text character.
- When the text is correct, click the yellow Store Button to save and store the text. The instrument will return to the Operation Mode

Location: 001 Text: [Unknown]

Text Editor Display

SETUP MODE

To enter the Set Up Mode:

1. Make sure the Ultraprobe is off.
2. Press (click) both the Yellow Store button and the Sensitivity dial at the same time. Only after these two controls have been pressed, then squeeze the trigger. NOTE: Hold the Trigger in during any of the Set Up Mode operations.
3. When in the first Menu mode: Data Transfer, you may move to any of the other Menu modes by spinning the Sensitivity.
4. Control up or down (clockwise or counter clockwise).
5. When the desired Menu mode is reached, push (Click) the Sensitivity Control in.
6. You may spin to enter and exit any Menu mode in the Set Up mod as long as the trigger on/off switch is pressed

Data Transfer

NOTE: Before downloading data, be sure the Ultraprobe is connected to the computer. To download data from the Ultraprobe to your computer:

1. Follow steps 1-3 in Set Up Mode
2. The first selection to be displayed on the screen will be Menu 01, Data Transfer.
3. Click the data Sensitivity Control Dial and all the data will be transferred to the PC. (NOTE: For software management, refer to Ultratrend™ Instructions.)

Set Time and Date

1. Make sure the Ultraprobe is off.
2. Press (click) both the Yellow Store button and the Sensitivity dial at the same time, then squeeze and hold the trigger.
3. When in the first Menu Selection : “Data Transfer” (Menu 01), you may move to any of the other Menu Selections by spinning the Sensitivity Control up or down (clockwise or counter clockwise).
4. Spin to “Set Time and Date” (Menu 02 blinks) and click in (EXIT Blinks), .
5. Spin to desired month or day or year and Click (selected number will blink rapidly).
6. Spin to select a new value
7. Click to set.
8. Spin to TIME setting and click on either Hour or Minute (the displayed number will blink rapidly).
9. Once an hour or minute has been selected, spin to select a new value. 10. Click to set.
10. When through, Spin the Sensitivity Control until EXIT flashes.
11. Click the Sensitivity Control again and return to the Set Up Mode.
12. Spin to Exit to PGM (Exit to Program) Menu 10 blinks. Click to enter Operation Mode.

Menu 02 Select
Set Time & Date

Time 15:30 Exit
Date 1/01/99

Click

dB Scale Select

dB Select has two settings from which to choose. These settings will determine the baseline dB reference level of the instrument. Once selected, all test results will be based on the selected baseline dB level. There are two scales: Relative and dB offset. Relative sets the instrument to the 0 dB of the instrument's internal minimal detection value and is the factory default setting. dB offset is a dB level that is a new minimum reference level set by the user. This value may be any dB level above the natural 0 dB of the instrument. Once set, the preset level must be subtracted from the reading to determine an accurate dB increase. (EG: if "10" is the dB offset value and a subsequent reading is 25 dB, then the increase is 15 dB.)

To select a dB reference scale:

1. Make sure the Ultraprobe is off.
2. Press (click) both the Yellow Store button and the Sensitivity dial at the same time, then squeeze and hold the trigger.
3. When in the first Menu Selection : "Data Transfer" (Menu 01), you may move to any of the other Menu Selections by spinning the Sensitivity Control up or down (clockwise or counter clockwise).
4. Spin to dB Scale Select (Menu 03 blinks).
6. Click in the Sensitivity Control.
7. Spin the Sensitivity Control to the desired scale (Relative or Offset).
8. Click the Sensitivity Control to set and return to the set up mode.
9. Spin to Exit to PGM (Exit to Program) Menu 10 blinks. Click to enter Operation Mode

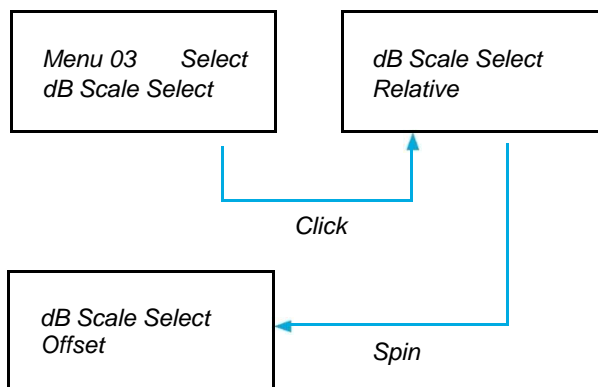

dB Offset

This position is selected to set the dB scale for readings to be taken in dB offset scale. In order to use the dB offset scale, refer to III above.

To set the dB offset scale:

1. Make sure the Ultraprobe is off.
2. button and the Sensitivity dial at the same time, then squeeze and hold the trigger.
3. When in the first Menu Selection : "Data Transfer" (Menu 01), you may move to any of the other Menu Selections by spinning the Sensitivity Control up or down (clockwise or counter clockwise).
4. Spin to dB Offset Val (value) (Menu 04 blinks) and click in the Sensitivity Control.
5. The dB Val (00) will blink.
6. Spin the Sensitivity Control to the desired dB value level.
7. Click the Sensitivity Control to set and return to Set Up Mode.
8. Spin to Exit to PGM (Exit to Program) Menu 10 blinks. Click to enter Operation Mode

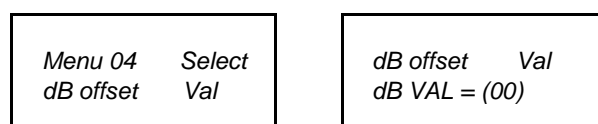



Display Mode

There are three modes to choose in Display Mode: Real Time, Snapshot and Peak Hold. Real Time is the standard operation of the instrument. For basic inspection operations choose Real Time. Snapshot is a very useful mode for inspections that require a comparison of measurements. Snapshot holds a specific reading on the display. The display can be updated by releasing and pressing the trigger. An example of this operation mode would be to locate the loudest point in a machine. By pointing the instrument at a loud signal and pulling the trigger, the sound intensity level will be displayed on the panel and held for comparison as the instrument is scanned around other points on the machine. The meter will remain constant while the audio levels change. Another example is performing a quick comparison of multiple bearings by pressing and releasing the trigger to update and compare sound levels. Peak Hold displays and holds the peak value for comparison. It changes only when a higher ultrasound level is sensed. The bar graph will move up and down to display sound intensities, but the Peak Hold dB reading in the upper left corner will remain constant. A thin vertical line on the bar graph indicates the peak intensity of the bar graph. The Peak Hold dB reading is reset by turning the instrument off or by changing the frequency.

To select Display Mode:

1. Make sure the Ultraprobe is off.
2. Press (click) both the Yellow Store button and the Sensitivity dial at the same time, then squeeze and hold the trigger.
3. When in the first Menu Selection : "Data Transfer" (Menu 01), you may move to any of the other Menu Selections by spinning the Sensitivity Control up or down (clockwise or counter clockwise).
4. Spin to Display Mode (Menu 05 Blinks).
5. Click the Sensitivity Control to enter Display Mode.
6. Spin the Sensitivity Control dial until the desired setting (Real Time, Snap Shot or Peak Hold) appears and blinks.
7. Click the Sensitivity Control Dial to set and return to Set Up Mode.
8. Spin to Exit to PGM (Exit to Program) Menu 10 blinks. Click to enter Operation Mode

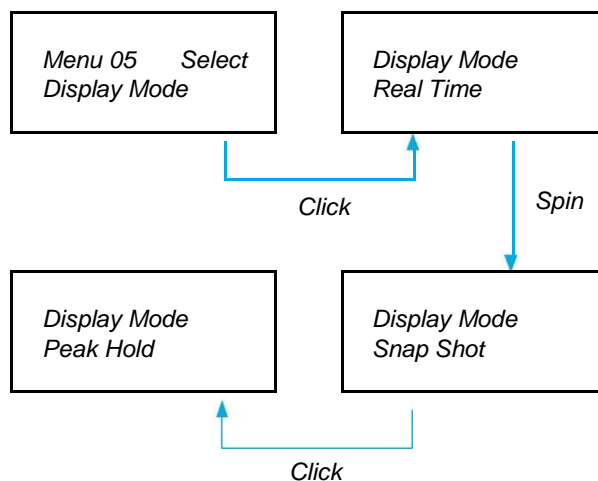

Calibration Due Date

Shown as Cal Due Date in the menu, this date is set at the factory and displays the recommended Recalibration/service date. This is one mode that cannot be changed by a user. It is only set at the factory after a service has been performed.

NOTE: This cannot be changed.

Text Editor

Text editor will enable or disable text entry when a reading is to be saved during the operation mode. If text notes are to be manually entered, select the ON mode. If text has been preset in the Ultratrend™ software or if text entry is not needed, select OFF.

To select Text Editor:

1. Make sure the Ultraprobe is off.
2. Press (click) both the Yellow Store button and the Sensitivity dial at the same time, then squeeze and hold the trigger.
3. When in the first Menu Selection , “Data Transfer” (Menu 01), you may move to any of the other Menu Selections by spinning the Sensitivity Control up or down (clockwise or counter clockwise).
4. Spin to Text Editor Sel (Select), Menu 07 blinks.
5. Click the Sensitivity Control Dial to enter the Text Editor enable mode.
6. Spin the Sensitivity Control Dial to select OFF or ON.
7. Click the Sensitivity Control Dial to set and return to Set Up Mode
8. Spin to Exit to PGM (Exit to Program) Menu 10 blinks. Click to enter Operation Mode

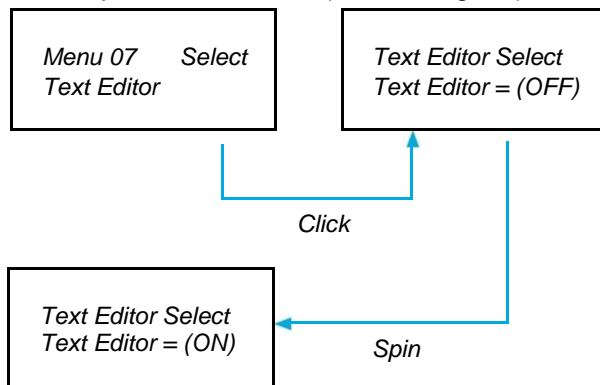

Date Format

The date format can be changed from the US standard (month/day/year) to the international format: (day/month/year).

To change the Date Format, make sure the Ultraprobe is off:

- Press (click) both the Yellow Store button and the Sensitivity dial at the same time, then squeeze and hold the trigger.
- When in the first Menu Selection , “Data Transfer” (Menu 01), you may move to any of the other Menu Selections by spinning the Sensitivity Control up or down (clockwise or counter clockwise).
- Spin to Date Format, Menu 08 blinks.
- Click the Sensitivity Control Dial to enter the Date Format enable mode.
- Click in the Sensitivity Control
- You will see mm/dd/yy blinking
- Spin the Sensitivity Control to dd/mm/yy
- Click the Sensitivity Control to exit

Factory Defaults

This mode allows users to retain or to delete the information stored in the instrument and to restore the factory default settings of the instrument. Confirm YES means that the onboard computer will default to original factory settings and all stored data will be deleted. Confirm NO retains all stored data and current instrument settings.

The Factory Default Settings:

- Maximum Sensitivity
- Frequency = 40 kHz
- Display Mode = Real Time
- dB Scale = Relative
- Offset Value = 0
- Text Editor = ON
- Peak Value Indicator (bar graph) = 0

To select Factory Defaults:

1. Make sure the Ultraprobe is off.
2. Press (click) both the Yellow Store button and the Sensitivity dial at the same time, then squeeze and hold the trigger.
3. When in the first Menu Selection : "Data Transfer" (Menu 01), you may move to any of the other Menu Selections by spinning the Sensitivity Control up or down (clockwise or counter clockwise).
4. Click to enter the Factory Default Set Up Mode
5. Spin up or down to select either YES or NO.
6. Click to set and return to Set Up Mode.
7. Spin to Exit to PGM (Exit to Program) Menu 10 blinks. Click to enter Operation Mode

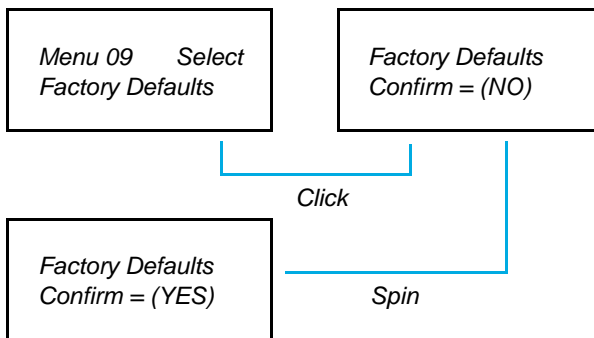

Exit to program

Click the Sensitivity Control dial and you will exit to Operations Mode.

USERS INSTRUCTIONS

Trisonic Scanning module

- Plug in to front end.
- Align the pins located at the rear of the module with the four jacks in the front end of the Metered Pistol Housing (MPH) and plug in.

- For general use position the frequency selection to 40 kHz.

Method of airborne detection

The method of air borne detection is to go from the „gross to the fine“. If there is too much ultrasound in the area, reduce the sensitivity, place the RUBBER FOCUSING PROBE (described below) over the scanning module and proceed to follow the test sound to its' loudest point constantly reducing the sensitivity and following the display

Headset

To use, simply plug the headset cord into the headset Jack on the pistol housing, and place the headphones over your ears. If a hard hat is to be worn, it is recommended to use UE Systems' model DHC-2HH hard hat headphones.

Rubber focusing probe

To use, simply slip it over the front of the scanning module or the contact module. NOTE: To prevent damage to the module plugs, always remove the module BEFORE attaching and/or removing the Rubber focusing Probe.

Stethoscope module

- Align the pins located at the rear of the module with the four jacks in the front end of the Metered Pistol Housing (MPH) and plug in.
- Touch test area.
As with the scanning module, go from the „gross“ to the „fine“. Start a maximum sensitivity on the Sensitivity Selection dial and proceed to reduce the sensitivity until a satisfactory sound level is achieved. At times it may be necessary to utilize the stethoscope probe with the sensitivity level at or near maximum. Occasionally when in this situation stray ultrasound may interfere with clear reception and be confusing. If this occurs, place the RUBBER FOCUSING PROBE over the Stethoscope probe to insulate against the stray ultrasound.

Stethoscope extension kit

1. Remove the Stethoscope Module from the Metered Pistol Housing.
2. Unscrew the metal rod in the Stethoscope Module.
3. Look at the thread of the rod you just unscrewed and locate a rod in the kit that has the same size thread this is the „base piece“.
4. Screw the Base Piece into the Stethoscope Module.
5. If all 78 cm are to be utilized, locate the middle piece. (This is the rod with a female fitting at one end) and screw this piece into the base piece.
6. Screw third „end piece“ into middle piece.
7. If a shorter length is desired, omit step 5 and screw „end piece“ into „base piece“.

To charge the UP9000

Plug recharger cable into recharger jack on the UP9000 and then plug the recharger into a wall receptacle.

- Make sure that the LED on the charger is lit when recharging.
- The LED turns OFF when the battery is charged. The instrument may stay connected to the charger without damaging the battery.

- **WARNING:** Use the supplied UE Systems recharger (BCH-9 or BCH-92) only. Use of unauthorized rechargers will void the warranty and may degrade or damage the battery.

Warble tone generator (UE-WTG-1)

- Turn Tone Generator on by selecting either „LOW“ for a low amplitude signal (usually recommended for small containers) or „HIGH“ for high amplitude. In high, the Warble Tone Generator will cover up to 113m³ of unobstructed space.
- When the Tone Generator is on, a red light (located below the recharge jack in the front) flickers.
- Place the Warble Tone Generator within the test item/container and seal or close it. Then scan the suspect areas with the Trisonic Scanning Module in the Ultraprobe and listen for where the „warble“ ultrasound penetrates. As an example, if the item to be tested is the seal around a window, place the Warble Tone Generator on one side of the window, close it and proceed to scan on the opposite side.
- To test the condition of the Warble Tone Generator battery, set to the LOW INTENSITY position and listen to the sound through the Ultraprobe at 40 kHz. A continuous warbling sound should be heard. If a „beeping“ is heard instead, then a full recharge of the Warble Tone Generator is indicated.

To charge the warble tone generator

- Plug recharger cable into recharger jack on the Warble Tone Generator and then plug the recharger into a wall receptacle.
- Make sure that the LED on the charger is lit when recharging.
- The LED turns OFF when the battery is charged.

Helpful hints

Before you begin your inspection activities, it is suggested that you review the applications section to become familiar with the basic inspection methods. Here are some helpful hints that should prove useful in some difficult situations.

If you can't read your display panel while testing:

- Trigger-release-Trigger method: Take the reading while holding the trigger in. Immediately press the STORE button and the reading will be set. If you do not wish to save the reading, click the Sensitivity dial and return to Operation Mode.

NOTE: The instrument turns off within 5 seconds if the trigger control switch is not held in.

- Snap Shot Method: If you know you are going to be in a situation where you won't be able to read the display panel, go into Set Up Mode and spin to Display Mode (Menu 5). Select Snap Shot and return to Operation Mode. This will hold your reading even while you continue to hold the trigger in. For a quick grab, take a reading, press the trigger in to hold it.

For an update or new reading, simply release and press the trigger switch.

Auto-shutdown battery feature

The Ultraprobe 9000 is equipped with an auto-shutdown feature, which enables the instrument to provide accurate measurement throughout the effective battery charge. If the Ultraprobe 9000 goes into the auto-shutdown mode, no sound will be heard in the headphones and measurements will not be displayed on the display panel. To restore the Ultraprobe 9000 to its' normal operating mode, recharge the instrument using the BCH-92 Battery Charger.

Resetting the on board computer

For security purposes, there is no reset switch on the instrument. Should it be necessary to reset the instrument, disconnect the battery for one (1) minute and then reconnect the battery.

Applications



Leak Detection

This section will cover airborne leak detection of pressure and vacuum systems. (For information concerned with internal leaks such as in Valves and Steam Traps, refer to the appropriate sections). What produces ultrasound in a leak? When a gas passes through a restricted orifice under pressure, it is going from a pressurized laminar flow to low pressure turbulent flow. (Fig. 1). The turbulence generates a broad spectrum of sound called „white noise“. There are ultrasonic components in this white noise. Since the ultrasound will be loudest by the leak site, the detection of these signals is usually quite simple.

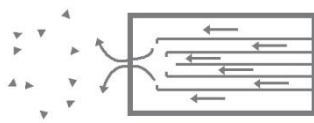

Figure 1: Pressure Leak

A leak can be in a pressurized system or in a vacuum system. In both instances, the ultrasound will be produced in the manner described above. The only difference between the two is that a vacuum leak will usually generate less ultrasonic amplitude than a pressure leak of the same flow rate. The reason for this is that the turbulence produced by a vacuum leak is occurring within the vacuum chamber while the turbulence of a pressure leak is generated in the atmosphere. (Fig.2).



Figure 2: Vacuum Leak

What type of gas leak will be detected ultrasonically? Generally any gas, including air, will produce a turbulence when it escapes through a restricted orifice. Unlike gas specific sensors, the Ultraprobe is sound specific. A gas specific sensor is limited to the particular gas it was designed to sense (e.g., helium). The Ultraprobe can sense any type of gas leak since it detects the ultrasound produced by the turbulence of a leak. Because of its versatility, the Ultraprobe may be utilized in a wide variety of leak detection. Pneumatic systems may be checked, pressurized cables, such as those utilized by telephone companies, may be tested. Air brake systems on railroad cars, trucks, and buses may be checked. Tanks, pipes, housings, casings and tubes are easily tested for leakage by pressurizing them. Vacuum systems, turbine exhausts, vacuum chambers, material handling systems, condensers, oxygen systems can all easily be tested for leakage by listening for the turbulence of the leak.

How to locate leaks

1. Use the TRISONIC SCANNING MODULE.
2. Start at 40 kHz. If too much background noise is present, try some of the shielding methods listed below.
3. Start off with the sensitivity at Maximum.
4. Begin to scan by pointing the module towards the test area. The procedure is to go from the „gross“ (loudest) to the „fine“ (refined sound discrimination)-more and more subtle adjustments will be made as the leak is approached.

5. If there is too much ultrasound in the area, reduce the sensitivity setting until you are able to determine the direction of the loudest sound and continue to scan.
6. Move closer to the test area as you scan
7. Continue to make adjustments with the sensitivity as needed in order to determine the direction of the leak sound.
8. If it is difficult to isolate the leak due to competing ultrasound, place the RUBBER FOCUSING PROBE over the scanning module and proceed to scan the test area.
9. Listen for a „rushing“ sound while observing the meter.
10. Follow the sound to the loudest point. The meter will show a higher reading as the leak is approached.
11. In order to focus in on the leak, keep reducing the sensitivity setting and move the instrument closer to the suspected leak site until you are able to confirm a leak.

To confirm a leak

Position the Trisonic Scanning Module, or the rubber focusing probe (if it is on the scanning module) close to the suspect leak site and move it, slightly, back and forth, in all directions. If the leak is at this location, the sound will increase and decrease in intensity as you sweep over it. In some instances, it is useful to position the rubber focusing probe directly over the suspect leak site and push down to „seal“ it from surrounding sounds. If it is the leak, the rushing sound will continue. If it is not the leak site, the sound will drop off

Overcoming difficulties

1. Competing Ultrasounds If competing ultrasounds make it difficult to isolate a leak, there are two approaches to be taken:
 - a. Manipulate the environment. This procedure is fairly straightforward. When possible, turn off the equipment that is producing the competing ultrasound or isolate the area by closing a door or window.
 - b. Manipulate the instrument and use shielding techniques. If environmental manipulation is not possible, try to get as close to the test site as possible, and manipulate the instrument so that it is pointing away from the competing ultrasound. Isolate the leak area by reducing the sensitivity of the unit and by pushing the tip of the rubber focusing probe up to the test area, checking a small section at a time. In some extreme instances, when the leak check is difficult at 40 kHz, try to „tune in“ to the leak sound by „tuning out“ the problem sound. In this instance adjust the frequency until the background sound is minimized and then proceed to listen for the leak.

Shielding techniques

Since ultrasound is a high frequency, short wave signal, it can usually be blocked or „shielded“. NOTE: When using any method, be sure to follow your plant's or company's safety guidelines.

Some common techniques are:

- a. Body: place your body between the test area and the competing sounds to act as a barrier
- b. Clip Board: Position the clip board close to the leak area and angle it so that it acts as a barrier between the test area and the competing sounds
- c. Gloved Hand: (USE CAUTION) using a gloved hand, wrap the hand around the rubber focusing probe tip so that the index finger and the thumb are close to the very end and place the rest of the hand on the test site so that there is a complete barrier of the hand between the test area and the background noise. Move the hand and instrument together over the various test zones.
- d. Wipe rag: This is the same method as the „gloved hand“ method, only, in addition to the glove, use a wipe rag to wrap around the rubber focusing probe tip. Hold the rag in the gloved hand so that it acts as a „curtain“, i.e., there is enough material to cover the test site without blocking the open end of the rubber focusing probe. This is usually the most effective method since it uses

three barriers: the rubber focusing probe, the gloved hand and the rag.

Barrier: When covering a large area, it is sometimes helpful to use some reflective material, such as a welders curtain or a drop cloth, to act as a barrier. Place the material so that it acts as a „wall“ between the test area and the competing sounds. Sometimes the barrier is draped from ceiling to floor, at other times, it is hung over railings.
Frequency Tuning: If there are situations where a signal may be difficult to isolate, it may be helpful to utilize the Frequency Tuning. Point the Ultraprobe toward the test area and gradually adjust the frequency until the weak signal appears to be clearer and then follow the basic detection methods previously outlined.

Low level leaks

In ultrasonic inspection for leakage, the amplitude of the sound often depends upon the amount of turbulence generated at the leak site. The greater the turbulence, the louder the signal, the less the turbulence, the lower the intensity of the signal. When a leak rate is so low that it produces little, if any turbulence that is „detectable“, it is considered „below threshold“.

If a leak appears to be of this nature:

1. Build up the pressure (if possible) to create greater turbulence.
2. Utilize LIQUID LEAK AMPLIFIER. This patented method incorporates a UE Systems product called LIQUID LEAK AMPLIFIER, or LLA for short. LLA is a uniquely formulated liquid substance that has special chemical properties. Used as an ultra sonic „bubble test, a small amount of LLA is applied to a suspected leak site, It produces a thin film through which the escaping gas will pass. When it comes in contact with a low flow of gas, it quickly forms a large number of small „soda-like“ bubbles that burst as soon as they form. This bursting effect produces an ultrasonic shock wave that is heard as a crackling sound in the headphones. In many instances the bubbles will not be seen, but they will be heard. This method is capable of obtaining successful leak checks in systems with leaks as low as 1×10^{-6} ml/sec.

NOTE: The low surface tension of the LLA is the reason small bubbles form. This can be negatively changed by contamination of the leak site with another leak fluid which can block LLA or cause large bubbles to form. If contaminated, clean the leak site with water, solvent or alcohol (check with plant regulations before selecting a decontaminating cleaning agent).

Use the UE-CFM-9 Close Focus Module. Specifically designed for low level leaks, the unique scanning chamber is designed to receive low level signals with reduced signal distortion and provides easier recognition of a low level leak. For more information, call the factory.

Tone test (Ultratone)

The Tone Test is an ultrasonic method for non-destructive testing which is used when it is difficult to pressurize or draw a vacuum in a system. This ultrasonic test is applicable to a wide range of items, including: CONTAINERS, TUBES, PIPES, HEAT EXCHANGERS, WELDS, GASKETS, SEALS, DOORS, WINDOWS, OR HATCHES.

The test is conducted by placing an ultrasonic transmitter, called TONE GENERATOR, inside (or on one side) of the test item. The warble pulse signal from the TONE GENERATOR will instantly „flood“ the test item and penetrate any existing leak hole. Depending on configuration and material, even thin spots in certain metals can be vibrated by the signal. By scanning for sonic penetration on the exterior surface (or opposite side) of the test item with the Ultraprobe, the leak will be detected. It will be heard as a high pitched warble, similar to bird chirping. The Tone Test incorporates two basic components: a TONE GENERATOR (an ultrasonic transmitter) , and the Trisonic Scanning Module in the Ultraprobe.

To conduct the test:

1. Make certain the test item has no fluids or contaminants such as water, mud, sludge, etc., that can

block the path of the transmitted ultrasound.

2. Place the Tone Generator within the container, (if it is a room, door or window to be tested, place the Tone Generator on one side pointing in the direction of the area to be tested) and close, or seal so that the Tone Generator is enclosed within.

NOTE: The size of the test area will determine the amplitude selection of the Tone Generator. If the item to be tested is small, select the LOW position. For larger items, use the HIGH position.

3. Scan the test area with the Ultraprobe as outlined in LEAK DETECTION procedure.

When positioning the Tone Generator, place the transducer facing and close to the most crucial test area. If a general area is to be checked, position the Tone Generator so that it will cover as wide an area as possible by placing it in the „middle“ of the test item. How far will the sound travel? The Tone Generator is designed to cover approximately 113m³ (4000 cubic feet) of uninterrupted space. This is slightly larger than the size of a tractor trailer. Placement is dependent upon such variables as the size of the leak to be tested, the thickness of the test wall and the type of material tested (i.e. is it sound absorbent or sound reflective?). Remember, you are dealing with a high frequency, short wave signal. If the sound is expected to travel through a thick wall, place the Tone Generator close to the test zone, if it is a thin metallic wall, move it farther back and use „low“. For uneven surfaces it may be necessary to use two people. One person will move the Tone Generator slowly close to and around the test areas while another person scans with the Ultraprobe on the other side.

Do not use the Tone test in a complete vacuum.

Ultrasound will not travel in a vacuum. Sound waves need molecules to vibrate and conduct the signal. There are no moveable molecules in a complete vacuum. If a partial vacuum is to be drawn where there are still some air molecules to vibrate, then the Tone Test may be implemented successfully.

In a laboratory, a form of the Tone Test is utilized in seal leaks of an electron beam microscope. The test chamber has been fitted with a specially designed transducer to emit the desired tone and a partial vacuum is created. A user then scans all seams for sonic penetration. The Tone Test has also been effectively utilized to test tanks before they are put on line, piping, refrigerator gaskets, caulking around doors and windows for air infiltration testing, heat exchangers for leaking tubes, as a Q.C. test for automobile wind noise and water leaks, on aircraft to test for problems associated with cabin pressure leaks and glove boxes for seal integrity defects.

UE SYSTEMS provides a variety of optional Warble Tone Generators.

They are:

WTG2SP Warble Pipe Tone Generator with a 1" male threaded nipple to adapt to various pipe fittings. It is used to test areas where the standard Tone Generators cannot be place such as in small pipes, sealed tanks or heat exchangers (see optional accessories, WTG-2SP).

UFMTG-1991 Multidirectional Tone Generator has four transducers that cover 360°. A Specially designed suction cup enables users to place the unit on a variety of surfaces, metal, plastic or glass. The UFMTG-1991 is used to detect leaks in unusual or large enclosures. Some applications include: testing bulkheads in ships, expansion joints in power plants and windshields in automobiles.

Transformers, switchgear another electrical apparatus



Electric arc, Corona, Tracking Detection

There are three basic electrical problems that are detected with the Ultraprobe 9000:

- Arcing:** An arc occurs when electricity is conducted to “ground”. Lightning is a good example.
- Corona:** When voltage on an electrical conductor, such as an antenna or high voltage transmission line exceeds the threshold value of the air around it, air begins to ionize and form a blue or purple glow.
- Tracking:** Often referred to as „baby arcing“, it follows the path of damaged insulation.

The Ultraprobe 9000 can be used in low (below 15 kV), medium (15 kV – 115 kV) and high voltage systems (above 115 kV).

When electricity escapes in high voltage lines or when it „jumps“ across a gap in an electrical connection, it disturbs the air molecules around it and generates ultrasound. Most often this sound will be perceived as a crackling or „frying“ sound, in other situations it will be heard as a buzzing sound. Typical applications include: insulators, cable, switchgear, buss bars, relays, circuit breakers, pot heads, junction boxes. In substations, components such as insulators, transformers and bushings may be tested.

Ultrasonic testing is often used in enclosed switchgear. Since ultrasound emissions can be detected by scanning around door seams and air vents, it is possible to detect serious faults such as arcing, tracking and corona without taking the switchgear off line as in an infrared scan. However, it is recommended that both tests be used with enclosed switchgear.

NOTE: When testing electrical equipment, follow all your plant or company safety procedures. When in doubt, ask your supervisor. Never touch live electrical apparatus with the Ultraprobe or its' accessories.

The method for detecting electric arc and corona leakage is similar to the procedure outlined in leak detection. Instead of listening for a rushing sound, a user will listen for a crackling or buzzing sound. In some instances, as in trying to locate the source of radio/TV interference or in substations, the general area of disturbance may be located with a gross detector such as a transistor radio or a wide-band interference locator. Once the general area has been located, the scanning module of the Ultraprobe is utilized with a general scan of the area. The sensitivity is reduced if the signal is too strong to follow. When this occurs, reduce the sensitivity to get a mid-line reading on the meter and continue following the sound until the loudest point is located.

Determining whether a problem exists or not is relatively simple. By comparing sound quality and sound levels among similar equipment, the problem sound will tend to be quite different. On lower voltage systems, a quick scan of bus bars often will pick up arcing or a loose connection. Checking junction boxes can reveal arcing. As with leak detection, the closer one gets to the emission site, the louder the signal.

If power lines are to be inspected and the signal does not appear to be intense enough to be detectable from the ground, use UE Systems UWC-9000 Ultrasonic Waveform Concentrator (a parabolic reflector) which will double the detection distance of the Ultraprobe and provide pinpoint detection. The UWC-2000 is recommended for those situations in which it may be considered safer to inspect electrical apparatus at a distance. The UWC2000 is extremely directional and will locate the exact site of an electrical discharge.

Another accessory is the LRM-9- Long Range Module which also increases the detection distance of the Ultraprobe. The basic difference is that the LRM is a one-hand operation but has a slightly wider detection area (11°) versus the UWC 9000 (5°).

Monitoring bearing wear

Ultrasonic inspection and monitoring of bearings is by far the most reliable method for detecting incipient bearing failure. The ultrasonic warning appears prior to a rise in temperature or an increase in low frequency vibration levels. Ultrasonic inspection of bearings is useful in recognizing:

- a. The beginning of fatigue failure.
- b. Brinelling of bearing surfaces.
- c. Flooding of or lack of lubricant

In ball bearings, as the metal in the raceway, roller or ball bearing begins to fatigue, a subtle deformation begins to occur. This deforming of the metal will produce irregular surfaces, which will cause an increase in the emission of ultrasonic sound waves.

Changes in amplitude from the original reading is indication of incipient bearing failure. When a reading exceeds any previous reading by 12 dB, it can be assumed that the bearing has entered the beginning of the failure mode.

This information was originally discovered through experimentation performed by NASA on ball bearings. In tests performed while monitoring bearings at frequencies ranging from 24 through 50 kHz, they found that the changes in amplitude indicate incipient (the onset of bearing failure before any other indicators including heat and vibration changes). An ultrasonic system based on detection and analysis of modulations of bearing resonance frequencies can provide subtle detection capability; whereas conventional methods are incapable of detecting very slight faults. As a ball passes over a pit or fault in the race surface, it produces an impact. A structural resonance of one of the bearing components vibrates or „rings“ by this repetitive impact. The sound produced is observed as an increase in amplitude in the monitored ultrasonic frequencies of the bearing.

Brinelling of bearing surfaces will produce a similar increase in amplitude due to the flattening process as the balls get out of round. These flat spots also produce a repetitive ringing that is detected as an increase in amplitude of monitored frequencies.

The ultrasonic frequencies detected by the Ultraprobe are reproduced as audible sounds. This „heterodyned“ signal can greatly assist a user in determining bearing problems. When listening, it is recommended that a user become familiar with the sounds of a good bearing. A good bearing is heard as a rushing or hissing noise. Crackling or rough sounds indicate a bearing in the failure stage. In certain cases a damaged ball can be heard as a clicking sound whereas a high intensity, uniform rough sound may indicate a damaged race or uniform ball damage. Loud rushing sounds similar to the rushing sound of a good bearing only slightly rougher, can indicate lack of lubrication. Short duration increases in the sound level with „rough“ or „scratchy“ components indicate a rolling element hitting a „flat“ spot and sliding on the bearing surfaces rather than rotating. If this condition is detected, more frequent examinations should be scheduled



Detecting bearing failure

There are two basic procedures of testing for bearing problems:

COMPARATIVE AND HISTORICAL. The comparative method involves testing two or more similar bearings and „comparing“ potential differences. Historical testing requires monitoring a specific bearing over a period of time to establish its history. By analyzing bearing history, wear patterns at particular ultrasonic frequencies become obvious, which allows for early detection and correction of bearing problems.

For comparative test:

1. Use contact (stethoscope) module.
2. Select desired frequency. (If only one frequency is to be monitored, consider using 30 kHz.
3. Select a „test spot“ on the bearing housing and mark it for future. Touch that spot with the contact module. In ultrasonic sensing, the more mediums or materials ultrasound has to travel through, the less accurate the reading will be. Therefore, be sure the contact probe is actually touching the bearing housing. If this is difficult, touch a grease fitting or touch as close to the bearing as possible.
4. Approach the bearings at the same angle, touching the same area on the bearing housing.
5. Reduce sensitivity to hear the sound quality more clearly.
6. Listen to bearing sound through headphones to hear the „quality“ of the signal for proper interpretation.
7. Select same type bearings under similar load conditions and same rotational speed.
8. Compare differences of meter reading and sound quality.

Procedure for bearing history (historical): Before starting with the HISTORICAL method for monitoring bearings, the COMPARATIVE method must be used to determine a baseline.

1. Use basic procedure as outlined above in steps 1-8.
2. Save the reading for future reference.
3. Compare this reading with previous (or future readings). On all future readings, adjust frequency to the original level.

If the decibel level has moved up 12 dB over the base line, it indicates the bearing has entered the incipient failure mode. Lack of lubrication is usually indicated by an 8 dB increase over baseline. It is usually heard as a loud rushing sound. If lack of lubrication is suspected, after lubricating, retest. If readings do not go back to original levels and remain high, consider bearing is on the way to the failure mode and recheck frequently.

Lack of Lubrication:

To avoid lack of lubrication, note the following:

1. As the lubricant film reduces, the sound level will increase. A rise of about 8 dB over baseline accompanied by a uniform rushing sound will indicate lack of lubrication.
2. When lubricating, add just enough to return the reading to base line.
3. Use caution. Some lubricants will need time to uniformly cover the bearing surfaces. Lubricate a small

amount at a time. DO NOT OVER-LUBRICATE

Over Lubrication:

One of the most common causes of bearing failure is over-lubrication. The excess pressure of the lubricant often breaks, or “pops” bearing seals or causes a build-up of heat, which can create stress and deformity.

To avoid over lubrication:

1. Don't lubricate if the base line reading and base line sound quality is maintained.
2. When lubricating, use just enough lubricant to bring the ultrasonic reading to baseline.
3. As mentioned above, use caution. Some lubricants will need time to uniformly cover the bearing surfaces.



*Proper Lubrication
Reduces Friction*



*Lack of Lubrication
Increases Amplitude
Levels*

Slow speed bearings

Monitoring slow speed bearings is possible with the Ultraprobe 9000. Due to the sensitivity range and the frequency tuning, it is quite possible to listen to the acoustic quality of bearings. In extremely slow bearings (less 25 RPM), it is often necessary to disregard the display and listen to the sound of the bearing. In these extreme situations, the bearings are usually large (1/2" and up) and greased with high viscosity lubricant. Most often no sound will be heard as the grease will absorb most of the acoustic energy. If a sound is heard, usually a crackling sound, there is some indication of deformity occurring. On most other slow speed bearings, it is possible to set a base line and monitor as described.

FFT Interface

The Ultraprobe may be interfaced with FFT's via the UE-MP-BNC-2 Miniphone to BNC connector or the UE DC2 FFT Adapter. The Miniphone plug is inserted into the headphone jack of the Ultraprobe and the BNC connector is attached to the analog-in connector of the FFT. There are also two accessories that connect to an FFT via the Ultraprobe I/O port. They are the 5PC MP (using a Miniphone connector to the FFT) and the 5PC-BNC (using a BNC connector to the FFT). These connectors enable an FFT to receive the heterodyned, (translated) low frequency sound information detected from the Ultraprobe. In this instance it can be used to monitor and trend bearings, including low speed bearings. It can also extend the use of the FFT to record all types mechanical information such as leaking valves, cavitation, gear wear, etc.

General mechanical trouble shooting

As operating equipment begins to fail due to component wear, breakage or misalignment, ultrasonic shifts occur. The accompanying sound pattern changes can save time and guesswork in diagnosing problems if they are adequately monitored. Therefore, an ultrasonic history of key components can prevent unplanned downtime. And just as important, if equipment should begin to fail in the field, the ULTRAPROBE can be extremely useful in trouble shooting problems.

TROUBLE SHOOTING:

1. Use the contact (stethoscope) module.
2. Touch test area(s): listen through headphones and observe the display.
3. Adjust sensitivity until mechanical operation of the equipment is heard clearly and the bar graph can fluctuate.
4. Probe equipment by touching various suspect areas.
5. If competing sounds in equipment being tested present a problem, try to „tune in“ to the problem sound by:
 - a. Probing equipment until the potential problem sound is heard.
 - b. Adjust Frequency slowly until the problem sound is heard more clearly.
6. To focus in on problem sounds, while probing, reduce sensitivity gradually to assist in locating the problem sound at its' loudest point. (This procedure is similar to the method outlined in LEAK LOCATION, i.e., follow the sound to its loudest point.)

Monitoring operating equipment

In order to understand and keep ahead of potential problems in operating equipment, it is necessary to establish base data and observe shifts in that data. This can be accomplished by data logging readings directly into the Ultraprobe or by recording sounds to a tape recorder (by connecting to the Headphone output, or to the I/O port using the proper cable. The heterodyned output can be downloaded to a spectral analysis program in a computer.

Procedure

1. Select key locations to be monitored and make permanent reference marks for future testing
2. Follow steps 1-2 as outlined above in the Trouble Shooting section.
3. Select a frequency for each test spot.
4. Save by hitting yellow store button (refer to Operation Mode: Yellow Store Button for description).

NOTE: In diagnosing any type of mechanical equipment, it is important to understand how that equipment operates. Being able to interpret sonic changes is dependent on a basic understanding of the operations of the particular equipment being tested. As an example, in some reciprocal compressors, the diagnosis of a valve problem in the inlet manifold is dependent on recognizing the distinctive clicking sound of a good valve vs. the muffled click of a valve in a „blow-by“ mode.

In gearboxes, before missing gear teeth may be detected as an abnormal click, the normal sounds of gears must be understood. In pumps, certain pumps will have surges, which may confuse inexperienced operators by the constant shifting of the intensity levels. The surge pattern must be observed before a lower, consistent bar graph reading can be recognized as the true reading.

faulty steam traps locating

An ultrasonic test of steam traps is a positive test. The main advantage to ultrasonic testing is that it isolates the area being tested by eliminating confusing background noises. A user can quickly adjust to recognizing differences among various steam traps, of which there are three basic types: mechanical, thermostatic and thermodynamic.

When testing steam traps ultrasonically:

1. Determine what type of trap is on the line. Be familiar with the operation of the trap. Is it intermittent or continuous drain?
2. Try to check whether the trap is in operation is it hot or cold? Use a non-contact infrared thermometer to determine this.
3. Use the contact (stethoscope) module.
4. Set Frequency to 25 kHz.
5. Try to touch the contact probe towards the discharge side of the trap. Press the trigger and listen.
6. Listen for the intermittent or continuous flow operation of the trap. Intermittent traps are usually the inverted bucket, thermodynamic (disc) and thermostatic (under light loads). Continuous flow: include the float, float and thermostatic and (usually) thermostatic traps. While testing intermittent traps, listen long enough to gauge the true cycle. In some cases, this may be longer than 30 seconds. Bear in mind that the greater the load that comes to it, the longer period of time it will stay open.

In checking a trap ultrasonically, a continuous rushing sound will often be the key indicator of live steam passing through. There are subtleties for each type of trap that can be noted.

Use the sensitivity levels of the Sensitivity Selection Dial to assist your test. If a low pressure system is to be checked, adjust the sensitivity UP: if a high pressure system (above 100 psi) is to be checked, reduce the sensitivity level. (Some experimentation may be necessary to arrive at the most desirable level to be tested.) Check upstream and reduce the sensitivity to hear the trap sounds more clearly and touch downstream to compare readings.

Frequency selection

Occasionally it may be necessary to „tune in“ to a steam trap. In some systems, specifically float type traps under low or moderate pressure load, a wide orifice will not produce too much ultrasound. If this is the case touch the trap on the downstream side. Adjust the frequency: start at 25 kHz. and listen for a lower frequency trickling sound of water. For other subtle trap sounds, such as determining the difference of condensate vs. steam sounds, try to listen at 40 kHz. If this proves difficult, gradually rotate the Frequency Selection Dial down (counterclockwise) until the specific sounds are heard.

Steam will have a light, gaseous sound; condensate will have additional overtones to its rushing sound.



General steam/condensate/flash steam confirmation

In instances where it may be difficult to determine the sound of steam, flash steam or condensate,

1. Touch at the immediate downstream side of the trap and reduce the sensitivity to hear the sounds more clearly.
2. Move 15-30 cm downstream and listen. Flashing steam will show a large drop off in intensity while leaking steam will show little drop off in intensity.

Inverted bucket traps

Inverted bucket traps normally fail in the open position because the trap loses its prime. This condition

means a complete blow-through, not a partial loss. The trap will no longer operate intermittently. Aside from a continuous rushing sound, another clue for steam blow-through is the sound of the bucket clanging against the side of the trap.

A float and thermostatic

A float and thermostatic trap normally fails in the „closed“ position. A pinhole leak produced in the ball float will cause the float to be weighted down or water hammer will collapse the ball float. Since the trap is totally closed no sound will be heard. In addition, check the thermostatic element in the float and thermostatic trap. If the trap is operating correctly, this element is usually quiet; if a rushing sound is heard, this will indicate either steam or gas is blowing through the air vent. This indicates that the vent has failed in the open, position and is wasting energy.

Thermodynamic (Disc)

Thermodynamic traps work on the difference in dynamic response to velocity change in the flow of compressible and incompressible fluids. As steam enters, static pressure above the disc forces the disc against the valve seat. The static pressure over a large area overcomes the high inlet pressure of the steam. As the steam starts to condense, the pressure against the disc lessens and the trap cycles. A good disc trap should cycle (hold-discharge-hold) 4-10 times per minute. When it fails, it usually fails in the open position, allowing continuous blow-through of steam.

Thermostatic traps (bellows & bi-metallic)

Thermostatic traps operate on a difference in temperature between condensate and steam. They build up condensate so that the temperature of condensate drops down to a certain level below saturation temperature in order for the trap to open. By backing up condensate, the trap will tend to modulate open or closed depending on load. In a bellows trap, should the bellows become compressed by water hammer, it will not function properly. The occurrence of a leak will prevent the balanced pressure action of these traps. When either condition occurs, the trap will fail in its natural position either opened or closed. If the trap falls closed, condensate will back up and no sound will be heard. If the trap falls open, a continuous rushing of live steam will be heard. With bimetallic traps, as the bimetallic plates set due to the heat they sense and the cooling effect on the plates, they may not set properly which will prevent the plates from closing completely and allow steam to pass through. This will be heard as a constant rushing sound.

NOTE: A complimentary Steam Trap Trouble Shooting Guide is available. Contact UE Systems directly by phone or email www.uesystems.eu



Locating faulty valves

Utilizing the contact (stethoscope) module in the Ultraprobe, valves can easily be monitored to determine if a valve is operating properly. As a liquid or gas flows through a pipe, there is little or no turbulence generated except at bends or obstacles. In the case of a leaking valve, the escaping liquid or gas will move from a high to a low pressure area, creating turbulence on the low pressure or „downstream“ side. This produces a white noise. The ultrasonic component of this „white noise“ is much stronger than the audible component. If a valve is leaking internally, the ultrasonic emissions generated at the orifice site will be heard and noted on the meter. The sounds of a leaking valve seat will vary depending upon the density of the liquid or gas. In some instances it will be heard as a subtle crackling sound, at other times

as a loud rushing sound. Sound quality depends on fluid viscosity and internal pipe pressure differentials. As an example, water flowing under low to mid pressures may be easily recognized as water. However, water under high pressure rushing through a partially open valve may sound very much like steam.

To discriminate:

1. Reduce the sensitivity.
2. Change the frequency to 25 kHz and listen. A properly seated valve will generate no sound. In some high pressure situations, the ultrasound generated within the system will be so intense that surface waves will travel from other valves or parts of the system and make it difficult to diagnose valve leakage. In this case it is still possible to diagnose valve blow-through by comparing sonic intensity differences by reducing the sensitivity and touching just upstream of the valve, at the valve seat and just downstream of the valve (see „Confirming Valve Leakage In Noisy Pipe Systems).

Procedure for valve check

1. Use stethoscope module.
2. Touch downstream side of valve and listen through headset.
3. Start test at 40 kHz. If the sound appears weak or confusing, change the frequency. As an example, try to test at 30 kHz. then 20 kHz.
4. When necessary, if there is too much sound, reduce sensitivity.
5. For comparative readings, usually in high pressure systems:
 - a. Touch upstream side and reduce sensitivity to minimize any sound.
 - b. Touch valve seat and/or downstream side.
 - c. Compare sonic differentials. If the valve is leaking, the sound level on the seat or downstream side will be equal to or louder than the upstream side.
6. In some instances, such as in noisy background or low viscosity fluids, it will be helpful to adjust the frequency to adequately interpret valve sounds. To do this:
 - a. Touch upstream of the valve and, in the Frequency Select Mode, gradually spin the Frequency until the stray signals are minimized or until the desired fluid flow is heard clearly.
 - b. Touch the upstream side, valve seat, downstream sides (as described above) and compare differences.

ABCD Method

The ABCD method is recommended to check for the potential of competing ultrasounds downstream that may carry back to the area of inspection and give a false indication of a valve leak. For the ABCD method,

1. Refer to steps 1-5 above.
2. Mark two equidistant points upstream (these will be point A and Point B) and compare them to two equidistant points downstream (point C and point D)

The sound intensity of points A and B are compared with test points C and D. If point C is higher than points A and B, the valve is considered leaking. If point D is higher than point C, this is an indication of sound being transmitted from another point downstream.

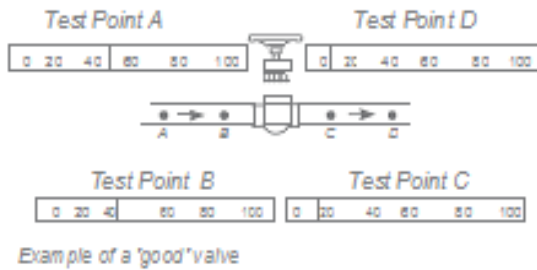

Confirming valve leakage in noisy pipe systems

Occasionally in high pressure systems, stray signals occur from valves that are close by or from pipes (or conduits) feeding into a common pipe that is near the down stream side of a valve. This flow may produce false leak signals. In order to determine if the loud signal on the downstream side is coming from a valve leak or from some other source:

1. Move close to the suspected source (i.e., the conduit or the other valve).
2. Touch at the upstream side of the suspected source.
3. Reduce sensitivity until the sounds are clearer.
4. Touch at short intervals (such as every 15-30 cm (6 - 12 inches) and note the meter changes.
5. If leaking.
6. If the sound level increases as you approach the test valve, It is an indication of a leak in the valve.

Miscellaneous problem areas

Underground leaks

Underground leak detection depends upon the amount of ultrasound generated by the particular leak. Some slow leaks will emit very little ultrasound. Compounding the problem is the fact that earth will tend to insulate ultrasound. In addition, loose soil will absorb more ultrasound than firm soil. If the leak is close to the surface and is gross in nature, it will be quickly detected. The more subtle leaks can also be detected but with some additional effort. In some instances it will be necessary to build up pressure in the line to generate greater flow and more ultrasound. In other cases it will be necessary to drain the pipe area in question, isolate the area by valving it off and inject a gas (air or nitrogen) to generate ultrasound through the leak site. This latter method has proven very successful. It is also possible to inject a test gas into the test area of the pipe without draining it. As the pressurized gas moves through the liquid into the leak site, it produces a crackling sound, which may be detected.

Procedure

1. Use contact (stethoscope) module.
2. Start Frequency Selection at 20-25kHz.
3. Touch surfaces over ground - DO NOT JAM probe to ground. Jamming can cause probe damage. In some instances it will be necessary to get close to the „source“ of the leak. In this situation, use a thin, sturdy metal rod and drive it down close to, but not touching, the pipe. Touch the contact probe to the metal rod and listen for the leak sound. This should be repeated approximately every 1-3 feet until the leak sound is heard. To locate the leak area, gradually position the rod until the leak sound is heard at its loudest point. An alternative to this is to use a flat metal disc or coin and drop it on the test area. Touch the disc and listen at 20 kHz. This is useful when testing concrete or asphalt to eliminate scratching sounds caused by slight movements of the stethoscope module on these surfaces.

Leakage behind walls

1. Look for water or steam markings such as discoloration, spots in wall or ceiling, etc.
2. If steam, feel for warm spots in wall or ceiling or use a non-contact infrared thermometer.
3. Set Frequency to 20 kHz and use stethoscope probe.
4. Listen for leak sounds. The louder the signal the closer you are to the leak site.

Partial blockage

When partial blockage exists, a condition similar to that of a bypassing valve is produced. The partial blockage will generate ultrasonic signals (often produced by turbulence just down stream). If a partial blockage is suspected, a section of piping should be inspected at various intervals. The ultrasound generated within the piping will be greatest at the site of the partial blockage.

Procedure

1. Use stethoscope module.
2. Touch downstream side of suspected area and listen through headset.
3. Start test at 40 kHz. If the sound appears weak or confusing, change the frequency. As an example, try to test at 30 kHz. then 20 kHz.
4. When necessary, if there is too much sound, reduce sensitivity.
5. Listen for an increase in ultrasound created by the turbulence of partial blockage.

Flow direction

Flow in piping increases in intensity as it passes through a restriction or a bend in the piping. As flow travels upstream, there is an increase in turbulence and therefore the intensity of the ultrasonic element of that turbulence at the flow restriction. In testing flow direction, the ultrasonic levels will have greater intensity in the DOWNSTREAM side than in the UPSTREAM side.

Procedure

1. Use stethoscope mode.
2. Start test in 40 kHz. If it is difficult hearing the flow signal, adjust the Frequency to 30 kHz or to 25 kHz.
3. Begin test at maximum sensitivity level.
4. Locate a bend in the pipe system (preferably 60 degrees or more).
5. Touch one side of bend and note dB reading.
6. Touch other side of bend and note dB reading.
7. The side with the higher (louder) reading should be the downstream side.

NOTE: Should it be difficult to observe a sound differential, reduce sensitivity and test as described until a sonic difference is recognized.

Ultrasound technology

The technology of ultrasound is concerned with sound waves that occur above human perception. The average threshold of human perception is 16,500 Hertz. Although the highest sounds some humans are capable of hearing is 21,000 Hertz, ultrasound technology is usually concerned with frequencies from

20,000 Hertz and up. Another way of stating 20,000 Hertz is 20 kHz, or KILOHERTZ. One kilohertz is 1,000 Hertz.

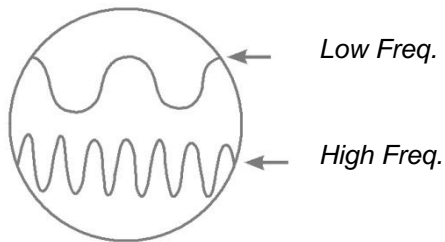

Figure A

Since ultrasound is a high frequency, it is a short wave signal. Its' properties are different from audible or low frequency sounds. A low frequency sound requires less acoustic energy to travel the same distance as high frequency sound. (Fig. A) The ultrasound technology utilized by the Ultraprobe is generally referred to as Airborne ultrasound. Airborne ultrasound is concerned with the transmission and reception of ultrasound through the atmosphere without the need of sound conductive (interface) gels. It can and does incorporate methods of receiving signals generated through one or more media via wave guides. There are ultrasonic components in practically all forms of friction. As an example, if you were to rub your thumb and forefinger together, you will generate a signal in the ultrasonic range. Although you might be able to very faintly hear the audible tones of this friction, with the Ultraprobe it will sound extremely loud.

The reason for the loudness is that the Ultraprobe converts the ultrasonic signal into an audible range and then amplifies it. Due to the comparative low amplitude nature of ultrasound, amplification is a very important feature.

Although there are obvious audible sounds emitted by most operating equipment, it is the ultrasonic elements of the acoustic emissions that are generally the most important. For preventative maintenance, many times an individual will listen to a bearing through some simple type of audio pick-up to determine bearing wear. Since that individual is hearing ONLY the audio elements of the signal, the results of that type of diagnosis will be quite gross. The subtleties of change within the ultrasonic range will not be perceived and therefore omitted. When a bearing is perceived as being bad in the audio range it is in need of immediate replacement. Ultrasound offers a predictable diagnostic capacity. When changes begin to occur in the ultrasonic range, there is still time to plan appropriate maintenance. In the area of leak detection, ultrasound offers a fast, accurate method of locating minute as well as gross leaks. Since ultrasound is a short wave signal, the ultrasonic elements of a leak will be loudest and most clearly perceived at the leak site. In loud factory type environments, this aspect of ultrasound makes it even more useful.

Most ambient sounds in a factory will block out the low frequency elements of a leak and thereby render audible leak inspection useless. Since the Ultraprobe is not capable of responding to low frequency sounds, it will hear only the ultrasonic elements of a leak. By scanning the test area, a user may quickly spot a leak.

Electrical discharges such as arcing, tracking and corona have strong ultrasonic components that may be readily detected. As with generic leak detection, these potential problems can be detected in noisy plant environments with the Ultraprobe.

Instructions for setting combination on carrying case

The combination is factory set at ,0-0-0,, Setting your personal combination:

1. Open the case. Looking at the back of the lock inside the case you will see a change lever. Move this change lever to the middle of the lock so that it hooks behind the change notch (picture 1).

2. Now set your personal combination by turning the dials to the desired combination (i.e. birthday, phone no. etc.)
3. Move the change lever back to the normal position (picture 2).
4. To lock, rotate one or more dials. To open the lock, set your personal combination. International patents pending.

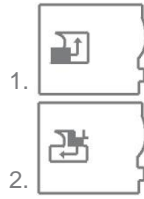
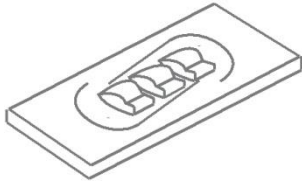

Ultraprobe® 9000 Specifications

Construction	Hand-held pistol type made with coated aluminum and ABS plastic
Circuitry	Solid State SMD Digital Circuitry with temperature compensation
Frequency	20 kHz to 100 kHz (tunable in 1 kHz increments)
Response Time	< 10 ms
Display	16 x 2 LCD with LED Backlight
Memory	400 storage locations
Battery	NiMH Rechargeable
Operating Temperature	0 °C to 50 °C (32 °F to 122 °F)
Outputs	Calibrated heterodyned output, decibel (dB) frequency, USB data output
Probes	Trisonic Scanning Module and Stethoscope Module
Headset	Deluxe noise attenuating headphones for hard hat use
Indicators	dB, Frequency, Battery Status and 16 Segment Bar Graph
Sensitivity	Detects 0.127 mm (0.005") diameter leak @ 0.34 bar (5 psi) at a distance of 15.24 m (50 ft.)
Threshold	1 x 10 ⁻² std. cc/sec to 1 x 10 ⁻³ std. cc/sec
Dimensions	Complete kit in Zero Halliburton aluminum carrying case 47 x 37 x 17 cm (18.5" x 14.5" x 6.5") Pistol Unit: 0.9 kg (2 lbs.) Complete carrying case: 6.4 kg (14 lbs.)
Weight	1 kg (2 lbs.)
Warranty	1-year parts/labor standard, 5 years with completed warranty registration card
Display Modes	Real Time, Snap Shot, Peak Hold and Storage Display *depends on leak configuration **specify Ex rating if needed at time of order

Annex A

Sensitivity Calibration Ultrasonic Tone Generator Method Ultraprobe 9000

It is advisable to check the sensitivity of your instrument before proceeding with your inspection. To assure reliability keep a record of all your sensitivity validation tests and be sure to keep your Warble Tone Generator charged.

Procedure:

1. Create a chart or use the one below:

Sensitivity Validation					
Scanning Module	Date	Serial #\	TG setting	Frequency	DB
Contact Module	Date	Serial #	TG setting	Frequency	DB

- A. For the Scanning Module, insert it into the front end of the instrument.
2. Select 40 kHz as the test frequency and note "40" in the Frequency box for the Scanning Module in the Sensitivity Validation Chart
3. Plug in the Headphones and adjust the ear pieces so that they are opened up and place them on the test table
4. In your kit select the longest of the Stethoscope extension probe rods.



5. Place an "L" in the Rod used box of your Sensitivity Validation Chart
6. Place the Tone generator on the side with the front facing you.

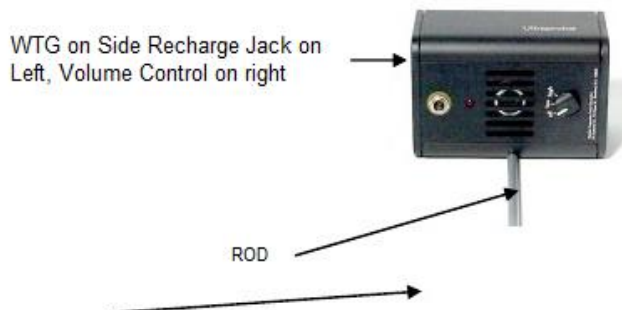

7. Place the rod in the middle of the transducer are (as above)
8. Select a volume level on the Warble Tone Generator (Low or High)
9. Note the level (L or H) in the TG box of the Sensitivity Validation chart.
10. Turn the Ultraprobe 9,000 on its' side so that it will rest flat on the test table with the handle facing you and the Scanning Module facing the Tone Generator.

11. Slide the Ultraprobe gently so that the front faceplate touches the Rod and that the rod is touching the face plate while touching the side of the Scanning Module. Align the Scanning

Module so that the center of the module is facing the center of the Tone Generator Transducer (see below).



12. Adjust the sensitivity until the intensity bar graph is at mid-line and displays the decibel level.
13. Note and record the decibel reading in the dB box of your Sensitivity Validation chart.

B. For the Contact (Stethoscope) Module, insert the Module into the Front End of the Instrument:

1. Select 40 kHz as the test frequency and note "40" in the Frequency box for the Contact Module in the Sensitivity Validation Chart
2. Plug in the Headphones and adjust the ear pieces so that they are opened up and place them on the test table
3. Place the Warble Tone Generator flat facing up with the recharge jack facing you at 90°.
4. Select a volume level on the Warble Tone Generator (High or Low).
5. Note the level (H or L) in the TG box of the Sensitivity Validation chart.
6. With the handle facing you, align the tip of the contact probe with the recharge jack and allow the probe to rest on the jack. **DO NOT PRESS DOWN!** (NOTE: NEVER USE THE ALUMINUM EXTENSION PROBE RODS THEY WILL SHORT OUT THE BATTERY OF THE WTG)
7. Adjust the sensitivity until intensity bar graph is at mid-line
8. Note and record the decibel in the dB box of your Sensitivity Validation chart.



For all tests:

Whenever you perform a Sensitivity Validation Test, review the data in the Sensitivity Validation chart and repeat the test using the same rod/module, frequency, and Warble Tone Generator volume setting.

Look for a change in the decibel reading. A change of greater than 6 dB will indicate a problem.

Need further support?
Want information regarding products or training?
Contact :



UE Systems Europe, Windmolen 20, 7609 NN Almelo (NL)
e: info@uesystems.eu w: www.uesystems.eu
t: +31 (0)546 725 125 f: +31 (0)546 725 126

www.uesystems.eu