



Sauter GmbH

Ziegelei 1
D-72336 Balingen
E-Mail: info@sauter.eu

Tel.: +49-[0]7433- 9933-199
Fax: +49-[0]7433-9933-149
Internet: www.sauter.eu

Instruction Manual Motorised PremiumTest Stand with Stepper Engine

SAUTER TVS

Version 1.1
05/2018
GB



PROFESSIONAL MEASURING

TVS -BA-e-1610



SAUTER TVS

Version 1.1 05/2018

Instruction Manual

Motorized Premium Test Stand with Stepper Engine

Thank you for purchasing the SAUTER TVS series premium test stand. We hope you are pleased with your high quality equipment and with its big functional range. With correct use, it will give you many years of accurate and reliable service. If you have any queries, wishes or helpful suggestions, we will be at your disposal for further advice and information.

Summary:

1	Introduction	3
2	Scope of delivery	3
3	Weight and Dimensions	3
4	Checking before use	3
5	Operation Overview	3
6	Specifications	4
7	Overview	5
	5
8	Control panel	5
9	Operation example	6
9.1	Examination before test:	6
9.2	Speed adjustment	7
9.3	How to pre-set Cycles	7
9.4	RS 232 Interface	7
9.5	Limit Function	7
10	Warning	7
11	Assembling instruction to a complete measurement system with internal and external force measuring cell	8
12	Cabling of TVS with a SAUTER force gauge and a length measuring device	13

1 Introduction

Compared to the TVM-N test stand, the TVS test stand is equipped with a stepper engine.

This allows very precise control of movements, and a stepper engine makes it possible to achieve very low speeds, also under very high loads.

Thanks to the stepper engine, it is possible to have very precise positioning, and speed is always constant, irrespectively of the load.

Moreover, using a stepper engine ensures a precise start and stop even at high speed and load levels – without overrun. Speed can be set in the control panel with a high degree of precision.

The TVS Premium test stand is suitable for the installation of all SAUTER dynamometers. In addition, it is equipped as a standard with longer guide columns ensuring a larger working area for measurements performed in the horizontal plane. Due to an enlarged working area, the test stand is suitable for all fixing options without a significant adverse impact on the working area itself. SAUTER offers optional software and additional accessories to ensure maximum configuration flexibility for your measurement system. For details, please contact SAUTER directly.

2 Scope of delivery

- SAUTER TVS
- Power cable
- Instruction manual

3 Weight and Dimensions

Dimensions in standard version (TVS 5000N240): LxBxH: 400 x 250 x 1550mm

Proper weight: 72 kg

Packing: robust wooden box

4 Checking before use

After having received the equipment, please check that no physical damage has occurred to the packaging material, to the wooden box or the test stand itself. If any damage is apparently, please contact SAUTER Company immediately.

5 Operation Overview

TVS series Test Stand can be specially applied with nearly all of the SAUTER series Force Gauge for tension and compression tests. It possesses presetting speed, a wide application range, advantage of non-polar speed adjustment, manual or automatic operation, suitable for application in fields of rubber & plastics, textile, construction, complex material, wires & cables, automobile accessories, engine and

scientific research, etc. It can be connected to a computer, when applied with SAUTER series force gauge, the test stand can be controlled, moving it up or down by our software AFH. Most of the SAUTER series force gauges also can preset the force stop, when the force has arrived the preset one, the test stand will auto-stop.

- Choose the right test stand depend on your request (see Chapter 6). Please do not test over maximum load of the test stand or the mounted force gauge. Adapt the force gauge you are going to use to the max. force or just be very carefully in adjusting the travelling distance (the force gauge might be damaged irrevocably!)
- Please do not open, to repair or to modify the equipment. This is not allowed, because you could damage the test stand. Please contact SAUTER GmbH.
- The equipment is not suitable for use in humid surroundings. Please avoid water or any liquids entering the housing, this could damage the mechanical drive.
- Please do not use any sharp-edged tools to operate the buttons of the control panel.
- Use the limit function with the limiting rings to control the travelling distance. An exact adjustment with the help of the limiting rings can avoid damages of the test stand and the force gauge applied.
- Add a little bit of lubricating grease to the columns of the test stand after a long time of work
- Turn off the equipment when you won't use it in short time, pull out the power plug when you do not use it for a longer period of time. Do not expose the equipment to humidity and dust.

6 Specifications

Model	Maximum force	Speed range
TVS 5000N240	5.000 N	1 -240 mm/min
TVS 10KN100	10.000 N	1 -200 mm/min
TVS 20KN100	20.000 N	1 -70 mm/min
TVS 30KN80	30.000 N	1 -70 mm/min
TVS 50KN80	50.000N	1 -70 mm/min

Max. travel distance (Y):	214 mm (secured by electronic end switches)
Speed precision:	1% of max.
Power supply:	230 V; 50/60 Hz
Operating temperature:	10 up to 30 °C

7 Overview

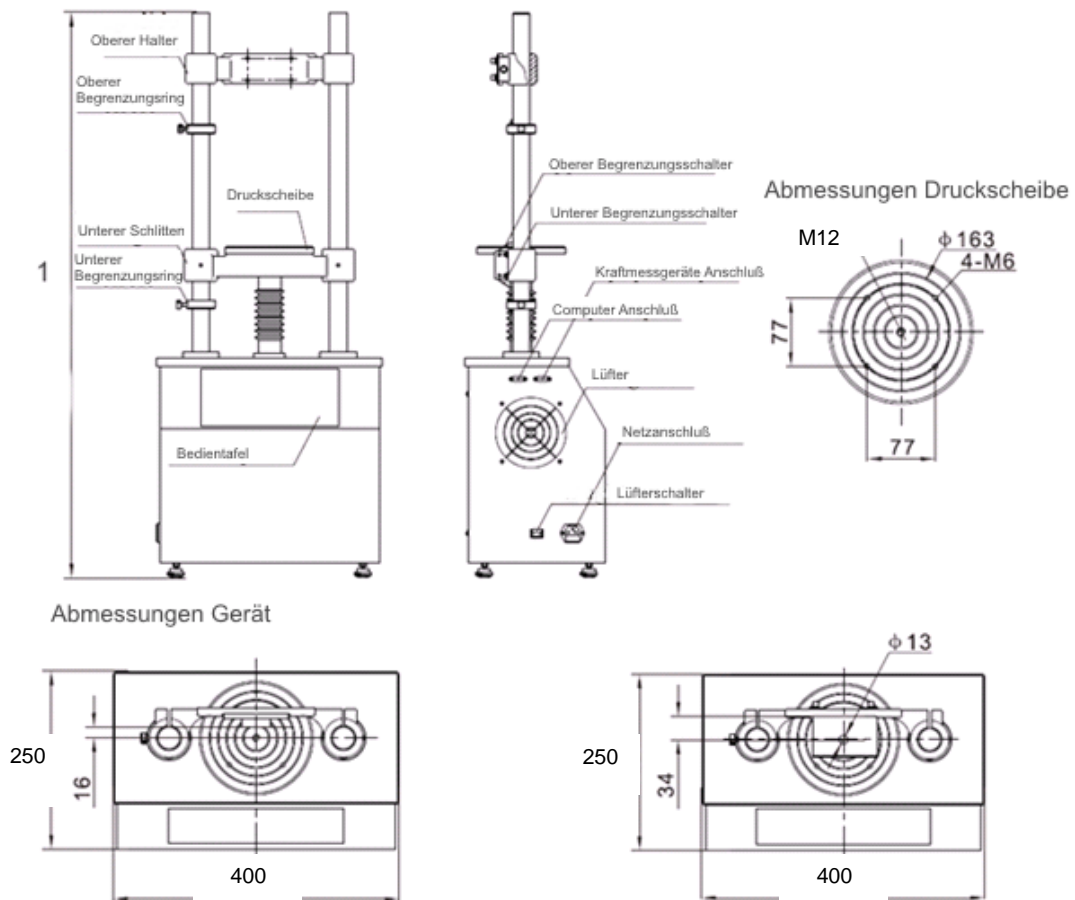

8 Control panel

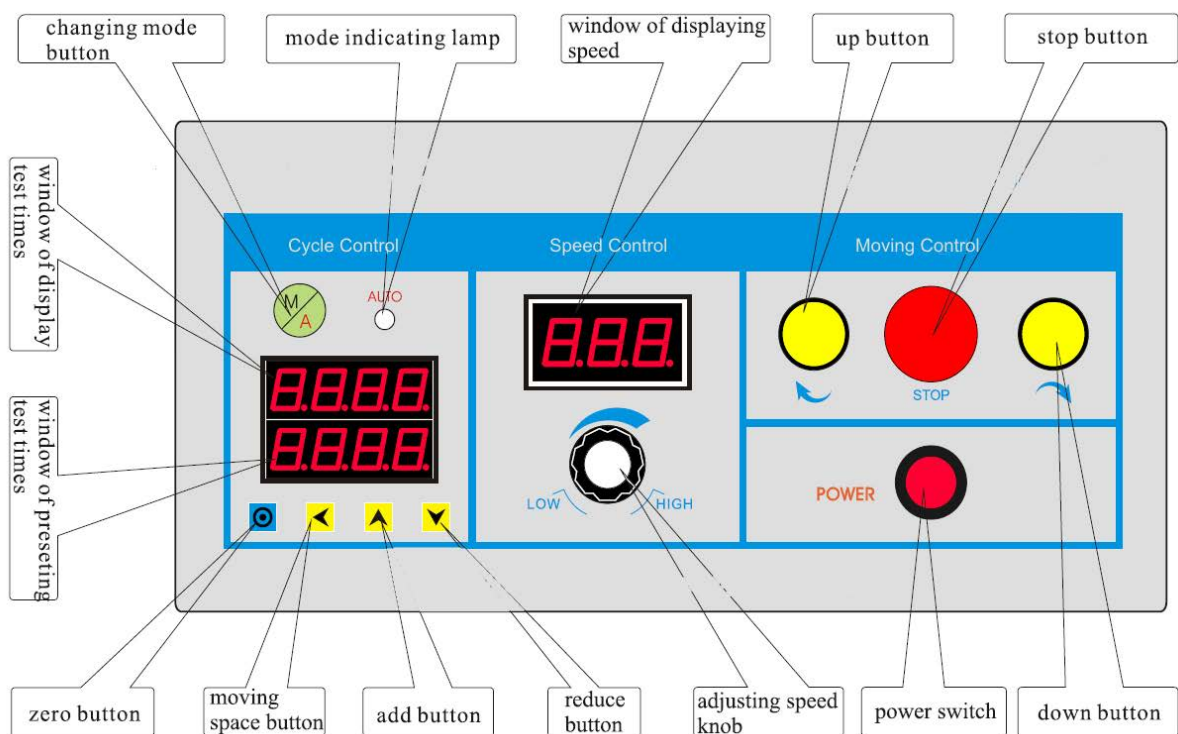

Power key: controls the whole machine's power, on and off.

Button UP: the lower sledge is moving upward, as long this button is pressed

Button DOWN: the lower sledge is moving upward, as long this button is pressed

STOP button: stops movement in Auto-mode

Speed adjusting knob: the moving speed can be adjusted

Manual / AUTO mode: choice between manual and automatic movement

Indication of preset cycles: here you can preset with the aid of counter +, counter + selection counter place a number of how many cycles the test stand shall make.

Indication of cycles run: here the number of cycles already done is indicated

Zero button: setting the preset and running times to zero

The movement of the test stand is determined by the lower and upper limiting ring. These limiting rings have to be preset before starting each new test.

9 Operation example

9.1 Examination before test:

- Cabling; turn on the power, the display automatically takes examination and simultaneously flickers 5 times, which is normal;
- First test the movement without test object, therefore use the limit switches manually to test its functions. Check the sound of the test stand in operation, if there is no abnormal sound to hear, everything is o.k.
- Manual test: The machine is defaulted to Manual Mode (M), in "Mode" state M the mode indicating lamp extinguishes, in the state of Manual test mode (M).The lamp starts shining, if being pressed continuously and the test stand starts moving up or down to test. If the upper or lower limit ring is touched during the test, the machine stops.
- Testing the automatic movement. Activate the Manual / Auto Mode push button, the Auto Mode indicator is flashes. Adjust the cycles (try to avoid the adjustment of "1") and start a test with the UP and DOWN buttons. After having finished the cycles, the test stand stands still and you will hear an alarm sound three times, so the test is finished.
- Single Automatic Test: Press "Changing Mode button" and pilot lamp of "AUTO" is on. A (Auto cycle) mode test is working. Press the UP or DOWN button, the lamp is on and the machine works to test. If "Changing Mode button" is pressed again, "AUTO" is off and you enter Manual test mode. Now the equipment keeps the original moving direction. If during the test the upper

or lower limit ring is touched, the test stand stops working and the test is finished.

9.2 Speed adjustment

Speed can be adjusted infinitely up to the max. possible speed before or during the test. This is displayed at the "Speed display window" if you adjust the speed with the "Adjusting Speed knob" The adjusted speed can be read on the display.

9.3 How to pre-set Cycles

It is possible to preset the number of cycles at the test stand. The pre-set value is shown in the sector below. It can be pre-set by the "add button" and "reduce button" as well as "moving space button". In the upper sector the number of the run cycles is displayed. It is possible to backspace (clean to zero) the display with the help of "zero button".

9.4 RS 232 Interface

This Test Stand is connected to the outside equipment by the RS-232 interface with 9 poles. The test stand is connected to the computer by RS-232, installing the SAUTER software (optional available, AFH-FAST/FD) from the CD to control movements up and down, to adjust the number of cycles directly at the PC and also the stop function of the test stand. By means of our software you can evaluate all data in relation to force, time or displacement

Connecting the port of the test stand to a SAUTER force gauge, the test stand can be piloted and there is the possibility of an overload protection; due to a parameter stop at the gauge FH; it can also record the force value curve.

Due to the inertia of the machine, the force value displayed on the force gauge will show overload when the test stops automatically. The value of the overload changes from the rigidity of the testing material. You can choose an appropriate low testing speed, or reduce the stop value accordingly.

9.5 Limit Function

In M (Manual) test mode, the movement will be stopped after the limit switches are reached.

In A(Automatic) test mode, the movement stops for about 5 seconds, reaching the limit switches and then starts again to move in opposite direction.

To guarantee an unobstructed working flow for the tests, please take care that the limit switches are positioned as exactly as possible, not to destroy the test equipment or the test object at a too long/short travel distance.

10 Warning

If force measurements are carried out incorrectly, this can lead to serious injuries of persons and objects. Therefore force measurements are only allowed to be carried out by trained and experienced staff!

Please avoid that forces are impacting from the test stand on the force gauge, which are exceeding the max. force of the measuring instrument or which do not impact directly from the test stand to the instrument.

Annotation:

To have a look at the CE Declaration of Conformity, please click onto the following link: <https://www.kern-sohn.com/shop/de/DOWNLOADS/>

11 Assembling instruction to a complete measurement system with internal and external force measuring cell

Unpack the test stand and check it for damages

Mount the adjusting feet and insert the plug of power supply



socket for power plug

Mounting a force gauge with INTERNAL sensor by means of an adaptor plate



Tighten the force gauge with an Allen key M3 at all 4 screws M3x8 (screws are included in delivery of the force gauges)

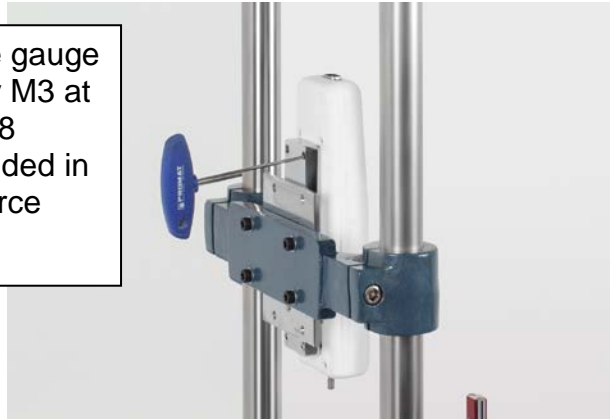

Force gauge with internal force cell mounting, finished:



Mounting of force gauges with EXTERNAL force measuring cell, starting from FH 1K

Removal of the existing adaptor plate for force gauges with internal force measuring cell with an Allen key M6



Fitting bracket AFM 41
with Allen screws
M6 x 35

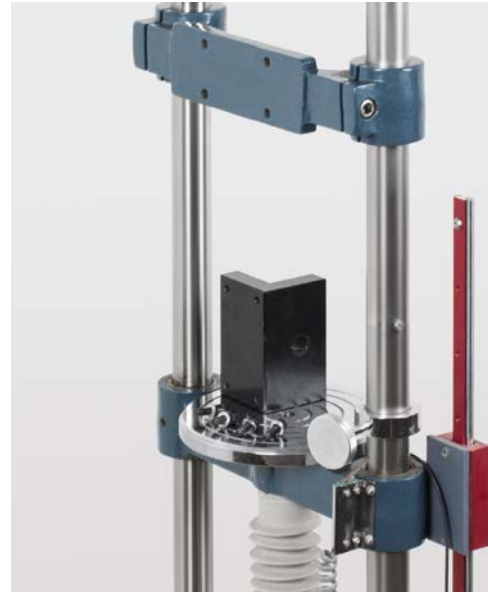

Fixing the fitting bracket AFM 41
with M6x35 Allen screws
steadily with an Allen key



The external force measuring cell has to be mounted at the fitting bracket AFM 41 with a M12x40 screw (at TVS 5KN and 10KN) and with a M12x80 screw (at TVS 20KN, TVS 30KN and TVS 50KN), included in delivery.



The external force measurement cell has to be connected with the display unit



The FH force gauge mounted on the test stand now has to be connected by means of the RS232 cable with the test stand to the Equipment-Port.

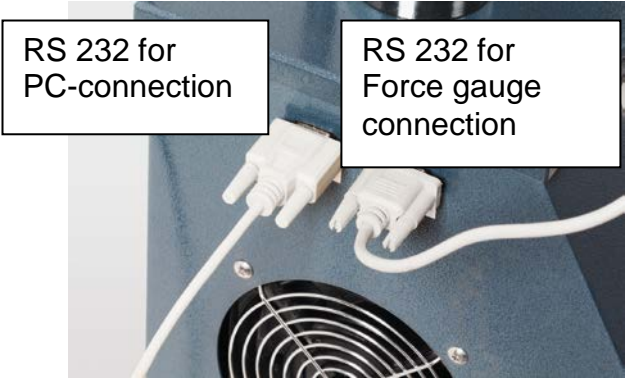

Cabling connections at TVS

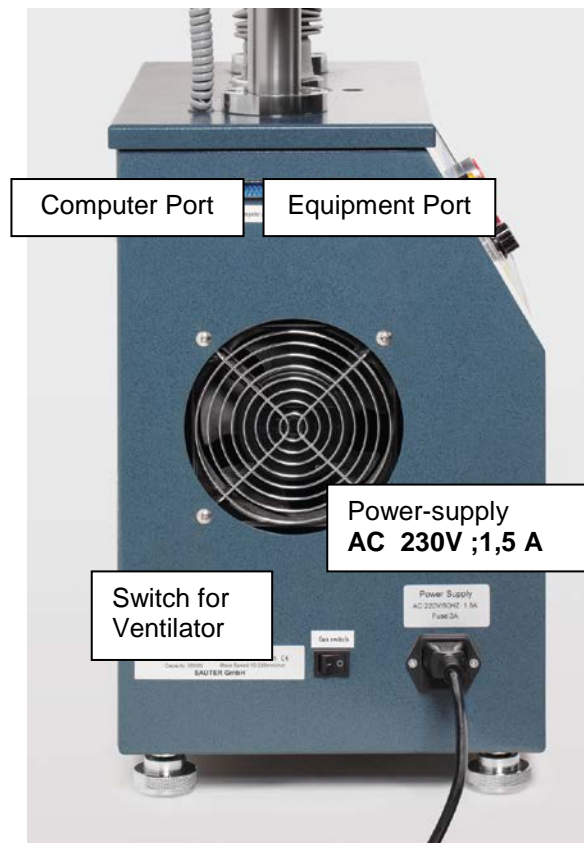

Test stand cabling with connection to a Computer

with FH-01 and AFH 12



12 Cabling of TVS with a SAUTER force gauge and a length measuring device

Here shown in an example with an FH. This is similar with all other compatible instruments of our SAUTER FL series.

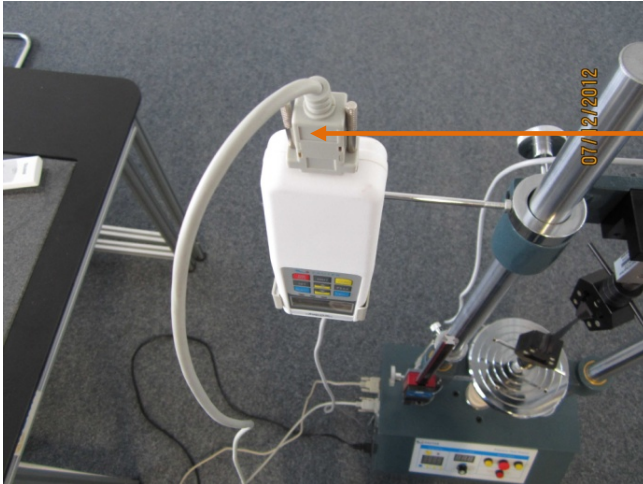

View from above FH with FH-A01 cable. A plug has to be inserted into the socket of the FH, the other one into the equipment port of TVS



The plug of the external force gauge measuring cell has to be plugged into the socket of the FH force gauge.



The connections of TVS:

The cable of FH has to be plugged into the right socket

The connection cable to a PC has to be plugged into the left socket (e.g. AFH 12)



Cabling of the length measuring device:

Insert the plug into the socket of the length measurement device and connect the other end to a PC (this depends on the length measurement device ordered)



If everything is connected, switch on the PC and all other instruments and start software.

Be sure that the chosen COM-port of your system has been identified and please compare it with the specified software accesses. If required, they have to be changed into the right one.

AFH 12 – USB-RS Converter

