



KERN & Sohn GmbH

Ziegelei 1
D-72336 Balingen
E-Mail: info@kern-sohn.com

Tel: +49-[0]7433-9933-0
Fax: +49-[0]7433-9933-149
Internet: www.kern-sohn.com

Operating instructions

Step-On Personal scale

KERN MPD

Typ MPD 250K100NM

Typ MPD 200K-1EM

Version 3.1

2018-02

GB



MPD_M-BA-e-1831

- D** Weitere Sprachversionen finden Sie online unter www.kern-sohn.com/manuals
- BG** Други езикови версии ще намерите в сайта www.kern-sohn.com/manuals
- DK** Flere sprogudgaver findes på websiden www.kern-sohn.com/manuals
- EST** Muud keeleversioonid leiate Te leheküljel www.kern-sohn.com/manuals
- E** Más versiones de idiomas se encuentran online bajo www.kern-sohn.com/manuals
- GR** Άλλες γλωσσικές αποδόσεις θα βρείτε στην ιστοσελίδα www.kern-sohn.com/manuals
- F** Vous trouverez d'autres versions de langue online sous www.kern-sohn.com/manuals
- LV** Citas valodu versijas atradīsiet vietnē www.kern-sohn.com/manuals
- FIN** Muut kieliversiot löytyvät osoitteesta www.kern-sohn.com/manuals
- LT** Kitas kalbines versijas rasite svetainėje www.kern-sohn.com/manuals
- GB** Further language versions you will find online under www.kern-sohn.com/manuals
- RO** Alte versiuni lingvistice veți găți pe site-ul www.kern-sohn.com/manuals
- I** Trovate altre versioni di lingue online in www.kern-sohn.com/manuals
- SK** Iné jazykové verzie nájdete na stránke www.kern-sohn.com/manuals
- NL** Bijkomende taalversies vindt u online op www.kern-sohn.com/manuals
- SLO** Druge jezikovne različice na voljo na spletni strani www.kern-sohn.com/manuals
- P** Encontram-se online mais versões de línguas em www.kern-sohn.com/manuals
- CZ** Jiné jazykové verze najdete na stránkách www.kern-sohn.com/manuals
- PL** Inne wersje językowe znajdą Państwo na stronie www.kern-sohn.com/manuals
- SE** Övriga språkversioner finns här: www.kern-sohn.com/manuals
- H** A további nyelvi változatok a következő oldalon találhatóak: www.kern-sohn.com/manuals
- HR** Druge jezične verzije su dostupne na stranici: www.kern-sohn.com/manuals
- LT** Kitas kalbines versijas rasite svetainėje www.kern-sohn.com/manuals
- NO** Andre språkversjoner finnes det på www.kern-sohn.com/manuals



KERN MPD
Version 3.1 2018-03
Operating instructions
Step-On Personal scale

Contents

1	Technical data	5
2	Declaration of conformity	6
2.1	Explanation of the graphic symbols for medical devices.....	6
3	Appliance overview	9
3.1	Overview of display.....	9
4	Basic Information (General)	10
4.1	Specific function.....	10
4.2	Proper use	10
4.3	Improper Use	11
4.4	Warranty	11
4.5	Monitoring of Test Resources	11
5	Basic Safety Precautions	12
5.1	Pay attention to the instructions in the Operation Manual.....	12
5.2	Personnel training.....	12
5.3	Preventing contamination.....	12
6	Electromagnetic compatibility (EMC)	13
6.1	General hints	13
6.2	Electromagnetic interferences.....	14
6.3	Electromagnetic noise immunity.....	15
6.3.1	Crucial features of performance.....	17
6.4	Minimum distances	18
7	Transport and storage	19
7.1	Testing upon acceptance	19
7.2	Packaging / return transport.....	19
8	Unpacking, Setup and Commissioning.....	20
8.1	Installation Site, Location of Use	20
8.2	Unpacking.....	20
8.3	Scope of delivery	20
8.4	Placing.....	21
8.5	Mains connection	21
8.6	Rechargeable battery operation (optional)	21
8.7	Battery operation.....	22
8.8	Initial Commissioning	23
9	Operation	24
9.1	Display backlight.....	24
10	Error messages	25
11	Service, maintenance, disposal	26
11.1	Cleaning	26
11.2	Cleaning / disinfecting.....	26
11.3	Sterilisation	26

11.4	Service, maintenance	26
11.5	Disposal	26
12	Instant help	27
13	Verification.....	28
13.1	Verification validity period (current status 2012 in G)	29
14	Adjustment	30

1 Technical data

KERN (Type)	MPD 250K100NM	MPD 200K-1EM
Model	MPD 250K100M	MPD 200K-1EM
Display	6-digit	
Weighing range (max)	250 kg	
Minimum load (Min)	2 kg	4 kg
Verification value (e)	100 g	200 g
Reproducibility	0.1 kg	0.2 kg
Linearity \pm	0.1 kg	0.2 kg
Display	LCD with 25mm high digits	
Recommended adjustment weight, (Class)	200 kg (M1)	
Stabilization time (typical)	3 sec.	
Warm-up time	10 min	
Operating temperature	0° C + 40° C	
Humidity of air	max. 80 % (not condensing)	
Electric Supply	Input voltage 110V-240V AC, 50/60 Hz	-
Balance (W x D x H) mm	365 x 490 x 120	
Weighing plate mm	365 x 360 x 80	
Weight kg (net)	8.9	8.7
Verified in accordance with 90/384/EEC	Medical grade III	
Medical product in accordance with 93/42/EEC	Category I with measuring function	
Rechargeable battery operation	optional 6x1.2V 2000 mA	-
Batteries	6 x 1.5 V AA	

2 Declaration of conformity

To view the current EC/EU Declaration of Conformity go to:

www.kern-sohn.com/ce

i The scope of delivery for calibrated weighing balances (= conformity-rated weighing balances) includes a Declaration of Conformity.

Solely these weighing balances are classified as medical devices.

2.1 Explanation of the graphic symbols for medical devices

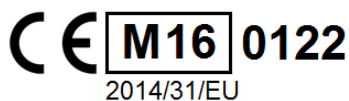

This marking indicates that these weighing balances are in conformity with EU Directive 2014/31/EU for non-automatic weighing balances. Weighing balances bearing this marking are licensed for medical purposes in the European Union.

The number inside the frame "M16" (example shown year 16) documents the year of conformity assessment.



This marking shows that this weighing balance is in conformity with EU Directive 93/42/EEC and inside the European Community is classified as medical device.

WF 170012

Designation of the serial number of every device, applied at the device and on the packaging

Number here as example



Identification of the manufacturing date of the medical product.

Year and month here as example



"Please note the accompanying documents"
or "Please note operating instructions"



“Please note operating instructions”



“Please note operating instructions”



Identification of manufacturer of medical product including address

Kern & Sohn GmbH
D-72336 Balingen,
Germany
www.kern-sohn.com



“Electro-medical appliance“
with attachment for type B

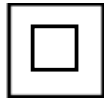

Device protection category II

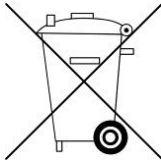

Dispose of old appliances separately from your household waste!

Instead, take them to communal collection points.



Display of supply voltage for scales with polarity display.



Mains connection



Sealing mark KERN SEAL



Supply voltage direct current



Information

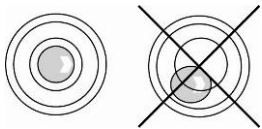

Level balance before use

3 Appliance overview

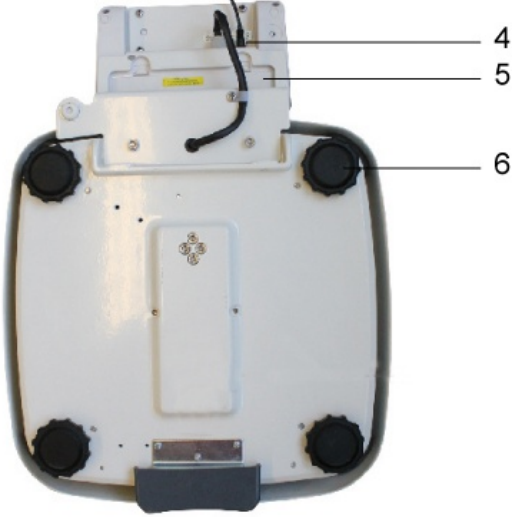
 <p>1 2 3</p>	<p>1 Display unit 2 Weighing platform (anti-slip surface) 3 Foot switch</p>
<p>Underside</p>  <p>4 5 6</p>	<p>4 Mains port 5 Rechargeable battery compartment 6 Rubber feet (adjustable height)</p>

3.1 Overview of display

Display	Description	Description
STABLE	Stability display	Scales are in a steady state
ZERO	Zeroing display	Weighing scale shows „0.0“.
GROSS	Gross weight display	Illuminated when gross weight is displayed

4 Basic Information (General)



Weighing instruments have to be verified for the purposes stated below in accordance with Directive 2014/31/EU. Article 1, paragraph 4. "Determination of mass in the practice of medicine that is, weighing patients for reasons of medical supervision during medical surveillance, examination and treatment."

4.1 Specific function

- Indication**
- Determining the body weight in the medical practice area.
 - Use as „non-standalone weighing scale“, that is, a person steps carefully onto the weighing platform's centre. Once a steady display value is shown, you can read the weight value.

- Contra-indication**
- No contraindication known

4.2 Proper use

This weighing scale is designed for determining the weight of a person whilst standing, such as in doctor's surgeries. The balance is suitable for recognising, preventing and controlling illnesses.



Scales fitted with a serial interface may only be connected to appliances in compliance with Directive EN60601-1.

On personal weighing scales, the person should step onto the centre of the weighing platform and remain standing without moving.

As soon as a stable weighing value is reached the weighing value can be read. The weighing scale is designed for continuous duty.



The weighing platform may only be stepped on by persons capable of standing on both feet on the weighing platform.

The weighing platforms are fitted with an anti-slip surface that must not be covered during weighing a person.

The balance should be checked for correct condition prior to each utilisation by a person familiar with proper operation of the balance.

4.3 Improper Use

Do not use these scales for dynamic weighing processes.

Do not leave permanent load on the weighing pan. This may damage the measuring system.

Impacts and overloading exceeding the stated maximum load (max) of the weighing plate, minus a possibly existing tare load, must be strictly avoided. This could cause damage to the balance.

Never operate balance in explosive environment. The serial version is not explosion protected. It should be noted that a flammable mixture of anaesthetics and oxygen or laughing gas may occur.

The structure of the balance may not be modified. This may lead to incorrect weighing results, safety-related faults and destruction of the balance.

The balance may only be used according to the described conditions. Other areas of use must be released by KERN in writing.

4.4 Warranty

Warranty claims shall be voided in case



- Our conditions in the operation manual are ignored
- The appliance is used outside the described uses
- The appliance is modified or opened
- mechanical damage and damage caused by media, liquids,
- natural wear and tear
- The appliance is improperly set up or incorrectly electrically connected
- The measuring system is overloaded
- Dropping the balance

4.5 Monitoring of Test Resources

In the framework of quality assurance the measuring-related weighing properties of the balance and, if applicable, the testing weight, must be checked regularly. The responsible user must define a suitable interval as well as type and scope of this test. Information is available on KERN's home page (www.kern-sohn.com) with regard to the monitoring of balance test substances and the test weights required for this. In KERN's accredited DKD calibration laboratory test weights and balances may be calibrated (return to the national standard) fast and at moderate cost.

5 Basic Safety Precautions

5.1 Pay attention to the instructions in the Operation Manual

	⇒ Carefully read this operation manual before setup and commissioning, even if you are already familiar with KERN balances.	
---	---	---

5.2 Personnel training

The medical staff must apply and follow the operating instructions for proper use and care of the product.

5.3 Preventing contamination

The prevention of cross-contamination (fungal skin infections,.....) requires regular cleaning of the weighing platform. Recommendation: after a weighing procedure that could potentially result in contamination (e. g. after weighing that involves direct skin contact).

6 Electromagnetic compatibility (EMC)

6.1 General hints



The installation and use of this electrical medical device MPD-M requires special precautionary measures as outlined in the EMC information below.

This device complies with the limits set for medical electrical devices of group 1, class B (as per EN 60601-1-2).

Electromagnetic compatibility (EMC) describes a device's ability to perform reliably within an electromagnetic environment without causing inadmissible electromagnetic interference at the same time. Amongst other things, such disturbances may be emitted by connecting cables or the air.

Inadmissible disturbances from the environment may result in incorrect displays, inaccurate measured values or incorrect behaviour of the personal scale MPD-M. By the same token the personal scale MPD-M may in some cases cause such disturbances in other devices. To eliminate problems of that kind, we recommend you to take one or several of the measures listed below:

- Change the alignment or distance of the device to the source of EMI.
- Install or use the personal scale MPD-M at a different location.
- Connect the personal scale MPD-M to a different power source.
- For further questions please contact our customer services.

Disturbances may be caused by improper modification or add-ons to the device or not recommended accessories (such as power units or connecting cables). The manufacturer will not be responsible for these. Modifications may also result in a loss of authorisation relating to the use of the device.



Devices emitting high frequency signals (mobile telephones, radio transmitters, radio receivers) may cause interference in the personal scale MPD-M. For that reason do not use them near the personal scale MPD-M. Chapter 6.4 contains details about recommended minimum distances.

6.2 Electromagnetic interferences

Guidelines and manufacturer's declaration – electromagnetic interferences		
The personal scale MPD-M is designed for use in an electromagnetic environment that meets the requirements stated below. The customer or user of the personal scale MPD-M must ensure that operation takes place in such an environment.		
Emitted interference measurements	Conformity	Electromagnetic environment - guideline
HF emissions as per CISPR 11 / EN 55011	Group 1	The personal scale MPD-M uses HF energy merely for its internal working. Its HF emission therefore is very low and it is highly unlikely to interfere with adjacent electronic devices.
HF emissions as per CISPR 11 / EN 55011	Class B	The personal scale MPD-M is designed for use in all equipment including those in living areas and those connected directly to the public power grid that also supplies buildings used for living purposes.
Emission of harmonics as per IEC 61000-3-2	Class A	
Emission of voltage fluctuations / flicker as per IEC 61000-3-3	Conforms with	

Do not put the personal scale MPD-M directly next to other devices and do not stack it with other devices. If this type of operation is necessary, observe the personal scale MPD-M to ensure normal operation in such an arrangement.

6.3 Electromagnetic noise immunity

Guidelines and manufacturer's declaration - electromagnetic noise immunity			
The personal scale MPD-M is designed for use in an electromagnetic environment that meets the requirements stated below. The customer or user of the personal scale MPD-M must ensure that operation takes place in such an environment.			
Noise immunity tests	IEC 60601 test level	Conformity	Electromagnetic environment - guideline
Discharge static electricity (DSE) as per IEC 61000-4-2	± 6 kV contact discharge ± 8 kV air discharge	± 6 kV ± 8 kV	Floors should be made of wood or concrete or tiled with ceramic tiles. If floors are covered with synthetic material, relative air humidity must be at least 30%.
Fast transient electrical disturbances / bursts as per IEC 61000-4-4	± 2 kV for power lines ± 1 kV for input and output lines	± 2 kV ± 1 kV	The quality of the supply voltage should match that of the typical business or hospital environment.
Impulse voltages / surges as per IEC 61000-4-5	± 1 kV voltage Live wire - live wire ± 2 kV voltage Live wire - earth	± 1 kV Inapplicable	The quality of the supply voltage should match that of the typical business or hospital environment.
Voltage dips, short-term disruptions and fluctuations in supply voltage as per IEC 61000-4-11	< 5 % U_T (> 95 % dip of U_T) for ½ period 40 % U_T (> 60 % dip of U_T) for 5 periods 70 % U_T (> 30 % dip of U_T) for 25 periods < 5 % U_T (> 95 % dip of U_T) for 5 s	Compliance with requirements under all postulated conditions Controlled switch off Return to undisturbed situation after user intervention.	The quality of the supply voltage should match that of the typical business or hospital environment. Where the user of the personal scale MPD-M demands continuous operation even during disruptions to the power supply, we recommend powering the personal scale MPD-M by no-break power supply or battery.
Magnetic field for supply frequency (50/60 Hz) as per IEC 61000-4-8	3 A/m	3 A/m 50/60 Hz	Magnetic fields for the supply frequency should match the typical values found in the particular business or hospital environment.
NOTE U_T equals AC line voltage prior to application of test level.			

Guidelines and manufacturer's declaration - electromagnetic noise immunity

The personal scale MPD-M is designed for use in an electromagnetic environment that meets the requirements stated below. The customer or user of the personal scale MPD-M must ensure that operation takes place in such an environment.

Noise immunity tests	IEC 60601 test level	Conformity	Electromagnetic environment - guideline
Conducted HF disturbance variables as per IEC 61000-4-6	3 V_{rms} 150 kHz to 80 MHz	3 V	Do not use portable or mobile radio sets nearer to the personal scale MPD 250K100M, MPD 250K100NM, MPD 200K-1EM or its wires than the distance recommended as safety distance which is calculated according to the equation relevant for its transmission frequency.
Emitted HF disturbance variables as per IEC 61000-4-3	3 V_{rms} 80 MHz to 2.5 GHz	3 V/m	<p>Recommended safety distance:</p> $d = 1.2\sqrt{P}$ $d = 1.2\sqrt{P}$ for 80 MHz to 800 MHz $d = 2.3\sqrt{P}$ for 800 MHz to 2.5 GHz Use P as rated capacity of radio transmitter in Watt (W) as per details given by the radio transmitter manufacturer and d as recommended safety distance in metres (m). The field intensity of stationary radio transmitters should for all frequencies be lower according to an in situ ^a examination than the conformity level. ^b Interference may occur near devices bearing the symbol below.



NOTE 1 Higher frequency range applies to 80 MHz and 800 MHz.

NOTE 2 These guidelines may not be applicable in all cases.
The spread of electromagnetic variables is influenced by absorption and reflections in buildings, objects and humans.

- ^a The field intensity of stationary radio transmitters such as base stations of wireless telephones and mobile radio sets, amateur radio stations, AM and FM radio and television stations cannot be reliably predicted in advance. To determine the electromagnetic environment in respect of stationary transmitters, you should consider a study of electromagnetic phenomena at the location. If the measured field intensity at the location where the personal scale MPD 250K100M, MPD 250K100NM, MPD 200K-1EM is to be used exceeds the conformity level above, you should observe the personal scale MPD 250K100M, MPD 250K100NM, MPD 200K-1EM in order to ensure normal operation. If you observe unusual features of performance you may have to take additional measures such as a change in alignment or a different location for the personal scale MPD 250K100M, MPD 250K100NM, MPD 200K-1EM.
- ^b For a frequency range of 150 kHz to 80 MHz field intensity should be less than 3 V/m.

6.3.1 Crucial features of performance

Note:



The personal scale MPD-M does not have any crucial features of performance as per IEC 60601-1. The system may be subject to interference by other devices even if these devices conform to current emission requirements as per CISPR.

6.4 Minimum distances

Recommended safety distances between portable and mobile HF telecommunication devices and the medical device

The personal scale MPD-M is designed for use in an electromagnetic environment in which HF disturbance variables are controlled. The customer or user of the personal scale MPD-M can help avoiding electromagnetic disturbances by keeping the minimum distance between portable and mobile HF telecommunication devices (transmitters) and the personal scale MPD-M – depending on the output performance of the communication device, as stated below.

Rated capacity of transmitter W	The safety distance depends on the transmission frequency m		
	150 kHz to 80 MHz $d = 1.2\sqrt{P}$	80 MHz to 800 MHz $d = 1.2\sqrt{P}$	800 MHz to 2.5 GHz $d = 2.3\sqrt{P}$
0.01	0.12	0.12	0.23
0.1	0.38	0.38	0.73
1	1.20	1.20	2.30
10	3.80	3.80	7.30
100	12.00	12.00	23.00

For transmitters with a maximum rated capacity not stated in the table above you can calculate the recommended safety distance in metres (m) yourself by using the equation belonging to each column, whereby P equals the maximum rated capacity of the transmitter in Watt (W) as per details provided by the transmitter manufacturer.

NOTE 1 Higher frequency range applies to 80 MHz and 800 MHz.

NOTE 2 These guidelines may not be applicable in all cases.

The spread of electromagnetic variables is influenced by absorption and reflections in buildings, objects and humans.

7 Transport and storage

7.1 Testing upon acceptance

When receiving the appliance, please check packaging immediately, and the appliance itself when unpacking for possible visible damage.

7.2 Packaging / return transport



- ⇒ Keep all parts of the original packaging for a possibly required return.
- ⇒ Only use original packaging for returning.
- ⇒ Prior to dispatch disconnect all cables and remove loose/mobile parts.
- ⇒ Reattach possibly supplied transport securing devices.
- ⇒ Secure all parts such as the weighing platform, power unit etc. against shifting and damage.

8 Unpacking, Setup and Commissioning

8.1 Installation Site, Location of Use

The balances are designed in a way that reliable weighing results are achieved in common conditions of use.

You will work accurately and fast, if you select the right location for your balance.

On the installation site observe the following:

- Place scales on a stable, even surface;
- Avoid extreme heat as well as temperature fluctuation caused by installing next to a radiator or in the direct sunlight;
- Protect the balance against direct draughts due to open windows and doors;
- Avoid jarring during weighing;
- Protect the balance against high humidity, vapours and dust;
- Do not expose the device to extreme dampness for longer periods of time. Non-permitted condensation (condensation of air humidity on the appliance) may occur if a cold appliance is taken to a considerably warmer environment. In this case, acclimatize the disconnected appliance for ca. 2 hours at room temperature.
- Avoid static charge of the balance and of the person to be weighed.
- Avoid contact with water.

Major display deviations (incorrect weighing results) may be experienced should electromagnetic fields (e.g. due to mobile phones or radio equipment), static electricity accumulations or instable power supply occur. Change location or remove source of interference.

8.2 Unpacking

Remove the individual components of the balance or the complete balance from the packaging with care and install at the intended location. When using the power pack, ensure that the power cable does not produce a risk of stumbling.

8.3 Scope of delivery

Serial accessories:

- Balance
- Power pack unit (EN 60601-1 attestation of conformity)
- Operating instructions

8.4 Placing

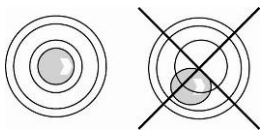

⇒ Level balance with foot screws until the air bubble of the water balance is in the prescribed circle.

⇒ Check levelling regularly.

8.5 Mains connection

only model MPD 250K100NM

Power is supplied by the external power unit which also serves to isolate the mains supply from the scale. The stated voltage value must be the same as the local voltage.

Always use genuine approved KERN power pack units as per EN 60601-1 directive.

The small sticker attached to the side of the display unit indicates the power port:



The LED remains illuminated as long as the weighing scale remains connected to the mains. The LED display informs you during loading about the loading status of the rechargeable battery.

green: Rechargeable battery completely reloaded

blue: Charging storage battery

8.6 Rechargeable battery operation (optional)

only model MPD 250K100NM

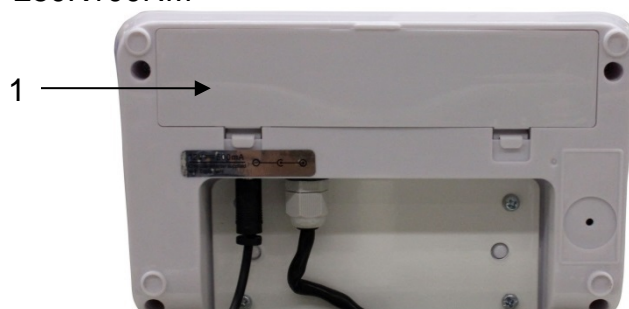

Open battery compartment cover (1) at the base of the display unit and insert battery. Charge the battery for at least 12 hours before initial use.

The appearance of the symbol  in the weight display indicates that the battery is almost exhausted. The weighing scale will remain ready for operation for a few more minutes before switching off in order to save battery. Load rechargeable battery.

 Voltage has dropped below prescribed minimum.

 Rechargeable battery very low.

 Rechargeable battery completely reloaded

If the balance is not used for a longer time, take out the rechargeable battery and store it separately. Leaking liquid could damage the balance.

8.7 Battery operation

As an alternative to rechargeable battery operation, the balance may also be operated with 6x AA batteries.



Open battery compartment cover (1) at the lower side of the display unit and insert batteries according to the example below. Lock the battery cover again. If the batteries are empty, in the balance display appears the symbol . Change batteries. To save battery power, the balance switches off automatically.

 Capacity of batteries exhausted.

 Batteries will soon be flat.

 Batteries are completely charged

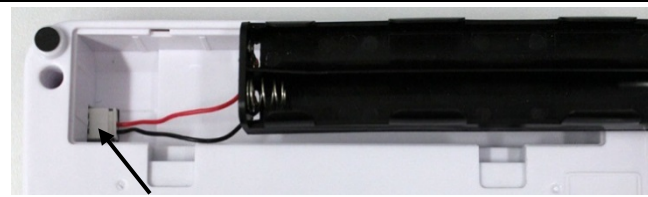
Insert batteries

Remove battery compartment cover	
Connect battery holder to housing contact acc. to illustration	
Insert battery holder	
Insert batteries into battery compartment and lock with battery compartment cover.	

8.8 Initial Commissioning

In order to obtain exact results with the electronic balances, your balance must have reached the operating temperature (see warming up time chap. 1). During this warming up time the balance must be connected to the power supply (mains, accumulator or battery) and be switched on.

The accuracy of the balance depends on the local acceleration of gravity.

The value of gravity acceleration is shown on the type plate.

9 Operation



⇒ Turn on weighing scale by foot switch (chap. 3).



⇒ The balance will carry out a self-test
The scales are ready for operation as soon as the weight display for "0.0 kg" has appeared.



⇒ Have person stand in the centre of the scales. Wait until the standstill display „STABLE“ appears, then read the weighing result.

9.1 Display backlight



⇒ Turn on the scales with the use of a foot switch.

⇒ The scales shall undergo automatic testing.
The scales is prepared for weighing right after the "0.0kg" mass indication is displayed.

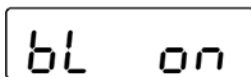

⇒ Press and hold the foot switch.
Background backlight setting options shall be displayed in sequence.

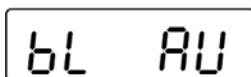

⇒ Select the demanded setting by means of pushing the switch for a while.
The indication shall blink for a while and then the selected setting will be applied.

bL on	Backlight is always turned on
bI AU	Automatic backlight turning off
bL oFF	Backlight always turned off

10 Error messages

Display **Description**

OL or----- **Weighing range has been exceeded (excess load)**

-----or Null **Below weighing range (underload)**

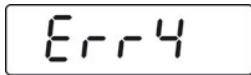

Zero range exceeded

(on start-up or when pressing the  key)

- Load on weighing pan
- Excess load, during zero setting of weighing scale
- Incorrect adjusting process
- Fault on load cell

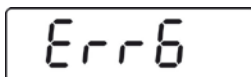

Value outside the A/D converter range

- Damaged weighing cell
- Damaged electronics



No possibility of zero point initiation

- Damage/overload of the measuring cell
- Objects present on the platform or having contact with it
- Unremoved transport protection
- Damage to the main board

Should other error messages occur, switch balance off and then on again. If the error message remains inform manufacturer.

11 Service, maintenance, disposal

11.1 Cleaning



Before any maintenance, cleaning and repair work disconnect the appliance from the operating voltage.

11.2 Cleaning / disinfecting

Clean weighing platform (such as seat) as well as casing with household detergents or commercially available disinfectants, e.g. 70% isopropanol. We recommend a disinfectant suitable for wiping disinfection. Please follow manufacturer's instructions.

Do not use abrasive or aggressive cleaners such as spirits or alcohol or similar as they might damage the high-quality surface.

To prevent cross-contamination (fungal skin infection) please observe the following time intervals for disinfection:

- Weighing plate before and after any measurement with direct skin contact
- When required:
 - Display
 - Touch-sensitive keyboard



Do not spray disinfectants onto appliance.

Make sure that disinfectant does not penetrate the interior of the balance.

Remove dirt immediately.

11.3 Sterilisation

Sterilisation of the appliance not allowed.

11.4 Service, maintenance

The appliance may only be opened by trained service technicians who are authorized by KERN.

Disconnect the scales before opening.

11.5 Disposal

Disposal of packaging and appliance must be carried out by operator according to valid national or regional law of the location where the appliance is used.

12 Instant help

In case of an error in the program process, briefly turn off the balance and disconnect from power supply. The weighing process must then be restarted from the beginning.

Fault

Possible cause

The displayed weight does not glow.

- The balance is not switched on.
- The mains supply connection has been interrupted (mains cable not plugged in/faulty).
- Power supply interrupted.
- Rechargeable battery inserted incorrectly or empty
- No rechargeable battery inserted

The displayed weight is permanently changing

- Draught/air movement
- Table/floor vibrations
- The weighing plate is in contact with foreign bodies or is not correctly positioned.
- Electromagnetic fields / static charging (choose different location/switch off interfering device if possible)

The weighing result is obviously incorrect

- The display of the balance is not at zero
- Adjustment is no longer correct.
- Great fluctuations in temperature.
- Warm-up time was ignored.
- Electromagnetic fields / static charging (choose different location/switch off interfering device if possible)

Should other error messages occur, switch balance off and then on again. If the error message remains inform manufacturer.

13 Verification

General introduction:

According to EU directive 2014/31/EU balances must be officially verified if they are used as follows (legally controlled area):

- a) For commercial transactions if the price of goods is determined by weighing.
- b) For the production of medicines in pharmacies as well as for analyses in the medical and pharmaceutical laboratory.
- c) For official purposes
- d) For manufacturing final packages
- e) For determining body mass, in medical practice for weighing patients for the purpose of monitoring, diagnosis and therapy

In cases of doubt, please contact your local trade in standard.

Verification notes:

An EU type approval exists for balances described in their technical data as verifiable. If a balance is used where obligation to verify exists as described above, it must be verified and re-verified at regular intervals.

Re-verification of a balance is carried out according to the respective national regulations. For verification validity period, s. chap. 11.1.

The legal regulation of the country where the balance is used must be observed!



Verification of the balance is invalid without the seal.

The seal marks attached on balances with type approval point out that the balance may only be opened and serviced by trained and authorised specialist staff. If the seal mark is destroyed, verification loses its validity. Please observe all national laws and legal regulations. In Germany a re-verification will be necessary.

Balances with obligation to verify must be taken out of operation if:

- The **weighing result** of the balance is outside the **error limit**. Therefore, in regular intervals load balance with known test weight (ca. 1/3 of the max. load) and compare with displayed value.
- The **reverification deadline** has been exceeded.

Position adjustment switch and seals:

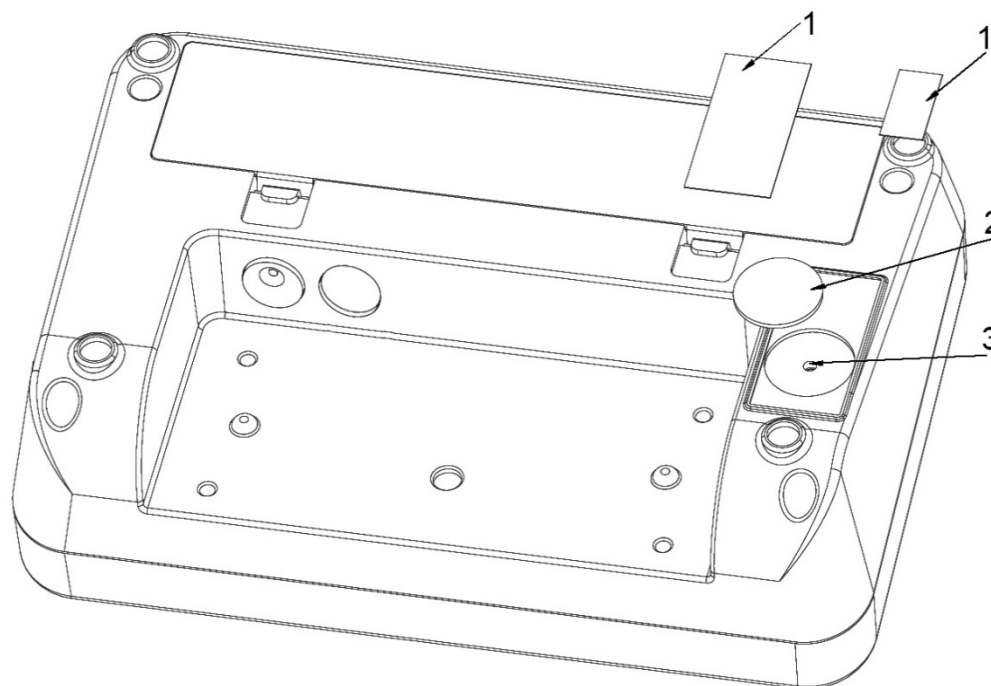

1. Self-destroying seal mark
2. Cover
3. Adjustment switch

13.1 Verification validity period (current status 2012 in G)

Personal scales (including chair and wheelchair scales) in hospitals	4 year
Personal scales, when not located in hospitals (for example, doctor's offices and nursing homes)	unlimited
Baby weighing scales and mechanical birth weight scales	4 year
Bed scales	2 year
Scales in dialysis stations	unlimited

Rehab clinics and health authorities are treated as hospitals.
(4 years of verification validity)

Not treated as hospitals (verification validity not limited) are dialysis stations, nursing homes and doctor's surgeries.

(Details derived from: „Information by the verification authority, weighing scales applied in medical use“)

14 Adjustment

As the acceleration value due to gravity is not the same at every location on earth, each display unit with connected weighing plate must be coordinated - in compliance with the underlying physical weighing principle - to the existing acceleration due to gravity at its place of location (only if the weighing system has not already been adjusted to the location in the factory). This adjustment process must be carried out for the first commissioning, after each change of location as well as in case of fluctuating environment temperature. To receive accurate measuring values it is also recommended to adjust the display unit periodically in weighing operation.



- Prepare the required adjustment weight. The adjustment weight to be applied depends on the capacity of a weighing scale, see chap. 1. Carry out adjustment as closely as possible to admissible maximum load of weighing scale. Information about test weights you will find in the internet under <http://www.kern-sohn.com>
- Observe stable environmental conditions. For warm-up time required for stabilisation see chap. 1.



The adjustment function is locked for verified balances.

To disable the access lock, destroy the seal and actuate the adjustment switch. Position of the adjustment switch see chap. 11.

Attention:

After destruction of the seal the weighing system must be re-verified by an authorised agency and a new verification wire/seal mark fitted before it can be reused for applications subject to verification.

Procedure:

- ⇒ Switch off the balance.
- ⇒ Press adjustment switch and turn on weighing scale by operating foot switch (chap. 3)..
- ⇒ Wait until the size of the adjustment weight (see chap. 1) required is displayed.

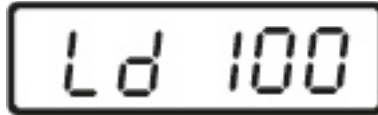
A rectangular digital display with a black border showing the text "Ld 100" in a black, monospaced font.

- ⇒ Place adjustment weight in the centre of the weighing platform. Wait until „Ld 0“ is shown.

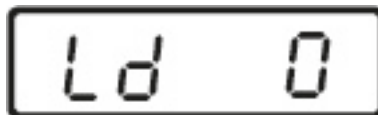
A rectangular digital display with a black border showing the text "Ld 0" in a black, monospaced font.

- ⇒ Take away adjustment weight. Ensure that there are no other objects on the weighing pan.

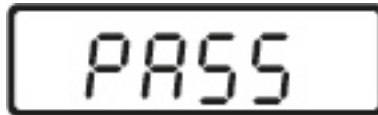
A rectangular digital display with a black border showing the text "PASS" in a black, monospaced font.

- ⇒ Wait for a few seconds until „PASS“ is displayed.
- ⇒ After successful adjustment the balance automatically returns to weighing mode.