

KERN

KERN & Sohn GmbH

Ziegelei 1
D-72336 Balingen
email: info@kern-sohn.com

Phone: +49-[0]7433- 9933-0
Fax: +49-[0]7433-9933-149
Internet: www.kern-sohn.com

Operating Manual **Analytical and precision balances**

KERN ALJ/ALS/PLJ/PLS

Version 4.2
2018-07
GB



ALJ/ALS/PLJ/PLS-BA-e-1842



KERN ALJ/ALS/PLJ/PLS

Version 4.2 2018-07

Operating Manual

Analytical and precision balances

Table of Contents

1	Technical Data	4
2	Declaration of Conformity	14
3	Device overview	15
3.1	Components	15
3.2	Operating elements	20
3.2.1	Overview of display	20
3.2.2	Keyboard overview	21
4	Basic Information (General)	22
4.1	Proper use	22
4.2	Improper Use	22
4.3	Warranty	22
4.4	Monitoring of Test Resources	22
5	Basic Safety Precautions	23
5.1	Pay attention to the instructions in the Operation Manual	23
5.2	Personnel training	23
6	Transportation & Storage	23
6.1	Testing upon acceptance	23
6.2	Packaging / return transport	24
7	Unpacking, Setup and Commissioning	26
7.1	Installation Site, Location of Use	26
7.2	Unpacking / placing	26
7.2.1	Placing	27
7.3	Mains connection	31
7.4	Connect and switch-on power supply	31
7.5	Rechargeable battery operation (depends on model, see chp.1)	32
7.6	Connection of peripheral devices	32
8	Adjustment	33
8.1	Models with external weight (KERN ALS/PLS)	33
8.1.1	Adjustment with recommended adjustment weight (factory setting)	33
8.1.2	Adjustment with weights of other nominal values	34
8.2	Models with internal weight (KERN ALJ/PLJ)	36
8.2.1	Adjustment models PLJ-M	37
8.2.2	Overwrite internal adjustment weight	38
8.3	Verification	39
9	Basic Operation	40
9.1	Underfloor weighing	41

10	User menu	42
10.1	Weighing unit	45
10.2	Data output type	46
10.3	Baud rate	47
10.4	Auto Zero	48
10.5	Filter	50
10.6	Standstill control display	51
10.7	Setting the contrast of the display	52
10.8	Display background illumination	53
10.9	Automatic switch-off function „AUTO OFF“ in stand-by mode	54
11	User menu	55
11.1	Parts counting	56
11.1.1	Switching over between quantity and weight display	58
11.1.2	Automatic reference optimization	58
11.1.3	Numeric entering of the reference weight	59
11.2	Density determination with the help of an underfloor weighing device	60
11.2.1	Density determination of solids	60
11.2.2	Determining density of liquids	62
11.3	Adding function	64
11.4	Checkweighing	66
11.5	Percent determination	68
11.5.1	Entering the reference weight by weighing	68
11.5.2	Numeric entering of the reference weight	69
11.6	Animal weighing function	70
11.7	Peak value function	71
12	Data output RS 232C	72
12.1	Technical Data	72
12.2	Pin allocation of balance output plug	72
12.3	Interface	73
12.4	Data transfer	73
12.5	Format for data transmission	74
12.6	Remote control instructions	76
12.7	Printer mode	76
13	Error messages	78
14	Service, maintenance, disposal	78
14.1	Cleaning	78
14.2	Service, maintenance	78
14.3	Disposal	79
15	Instant help	79

1 Technical Data

KERN	ALJ 160-4A	ALJ 200-5DA
Weighing range (max)	160 g	82 g / 220 g
Readability (d)	0.1 mg	0.01 mg / 0.1 mg
Reproducibility	0.1 mg	0.04 mg / 0.1 mg
Linearity	± 0.3 mg	± 0.1 mg / 0.2 mg
Stabilization time (typical)	4 sec.	6 sec.
Minimum unit weight at piece counting under laboratory conditions *	1 mg	1 mg
Minimum unit weight at piece counting under normal conditions **	10 mg	10 mg
Warm-up time	8 hours	
Adjustment weight	internal	
Reference quantities at piece counting	10, 25, 50, 100 freely selectable	
Weighing Units	ct, g, gn, lb, mo, oz, ozt, tl (HK), tl (Singap. Malays), tl (Tw), pen	
Electric Supply	24 V AC, 500mA	
Operating temperature	+ 5° C + 35° C	
Humidity of air	max. 80 % (not condensing)	
Housing (B x D x H) mm	210 x 340 x 330	
Dimensions of windshield (B x D x H) mm	160 x 140 x 205 (inside) 190 x 195 x 225 (outside)	160 x 170 x 225 (inside) 190 x 195 x 225 (outside)
Weighing plate (stainless steel)	Ø 80 mm	
Weight kg (net)	6.5 kg	7 kg
Interface	RS 232C	
Pollution Degree	2	
Overvoltage Category	Category II	
Altitude	Up to 4000 m	
Installation Site	device may only be used indoors	

KERN	ALJ 250-4A	ALJ 310-4A	ALJ 500-4A
Weighing range (max)	250 g	310 g	510 g
Readability (d)	0.1 mg	0.1 mg	0.1 mg
Reproducibility	0.1 mg	0.1 mg	0.2 mg
Linearity	± 0.3 mg	± 0.3 mg	± 0.4 mg
Stabilization time (typical)	4 sec.	4 sec.	4 sec.
Minimum unit weight at piece counting under laboratory conditions *	1 mg	1 mg	1 mg
Minimum unit weight at piece counting under normal conditions **	10 mg	10 mg	10 mg
Warm-up time	8 hours		
Adjustment weight	internal		
Reference quantities at piece counting	10, 25, 50, 100 freely selectable		
Weighing Units	ct, g, gn, lb, mo, oz, ozt, tl (HK), tl (Singap. Malays), tl (Tw), pen		
Electric Supply	24 V AC, 500mA		
Operating temperature	+ 5° C + 35° C		
Humidity of air	max. 80 % (not condensing)		
Housing (B x D x H) mm	210 x 340 x 330		
Dimensions of windshield (B x D x H) mm	160 x 140 x 205 (inside) 190 x 195 x 225 (outside)		
Weighing plate (stainless steel)	Ø 80 mm		
Weight kg (net)	6.5 kg		
Interface	RS 232C		

KERN	ALJ 160-4AM	ALJ 250-4AM
Product No / Type	TALJ 160-4BM-A	TALJ 250-4BM-A
Weighing range (max)	160 g	250 g
Readability (d)	0.1 mg	0.1 mg
Reproducibility	0.1 mg	0.1 mg
Linearity	± 0.3 mg	± 0.3 mg
Verification value (e)	1 mg	1 mg
Verification class	I	I
Minimum load (Min)	10 mg	10 mg
Stabilization time (typical)	4 sec.	4 sec.
Minimum unit weight at piece counting under laboratory conditions *	0,1 mg	0,1 mg
Minimum unit weight at piece counting under normal conditions **	1 mg	1 mg
Warm-up time	8 hours	
Adjustment weight	internal	
Reference quantities at piece counting	10, 25, 50, 100 freely selectable	
Weighing Units	ct, g, gn, lb, mo, oz, ozt, tl (HK), tl (Singap. Malays), tl (Tw), pen	
Electric Supply	24 V AC, 500 mA	
Operating temperature	+ 5° C + 35° C	
Humidity of air	max. 80 % (not condensing)	
Housing (B x D x H) mm	210 x 340 x 330	
Dimensions of windshield (B x D x H) mm	160 x 140 x 205 (inside) 190 x 195 x 225 (outside)	
Weighing plate (stainless steel)	Ø 80 mm	
Weight kg (net)	5.7 kg	6.7 kg
Interface	RS 232C	

KERN	ALS 160-4A	ALS 250-4A
Weighing range (max)	160 g	250 g
Readability (d)	0.1 mg	0.1 mg
Reproducibility	0.1 mg	0.1 mg
Linearity	± 0.3 mg	± 0.3 mg
Stabilization time (typical)	4 sec.	4 sec.
Minimum unit weight at piece counting under laboratory conditions *	1 mg	1 mg
Minimum unit weight at piece counting under normal conditions **	10 mg	10 mg
Warm-up time	8 h	
Recommended adjustment weight, not added (class)	150 g (E2)	200 g (E2)
Reference quantities at piece counting	10, 25, 50, 100 freely selectable	
Weighing Units	ct, g, gn, lb, mo, oz, ozt, tl (HK), tl (Singap. Malays), tl (Tw), pen	
Electric Supply	24 V AC, 500 mA	
Operating temperature	+ 5° C + 35° C	
Humidity of air	max. 80 % (not condensing)	
Housing (B x D x H) mm	210 x 340 x 330	
Dimensions of windshield (B x D x H) mm	160 x 140 x 205 (inside) 190 x 195 x 225 (outside)	
Weighing plate (stainless steel)	Ø 80 mm	
Weight kg (net)	5.7 kg	
Interface	RS 232C	

KERN	PLJ 420-3F	PLJ 720-3A	PLJ 1200-3A
Weighing range (max)	420 g	720 g	1200 g
Readability (d)	0.001 g	0.001 g	0.001 g
Reproducibility	0.001 g	0.001 g	0.001 g
Linearity	± 0.003 g	± 0.002 g	± 0.003 g
Stabilization time (typical)	2 sec.	2 sec.	2 sec.
Minimum unit weight at piece counting under laboratory conditions *	5 mg	1 mg	5 mg
Minimum unit weight at piece counting under normal conditions **	50 mg	10 mg	50 mg
Warm-up time	4 h	4 h	8 h
Adjustment weight	internal		
Reference quantities at piece counting	10, 25, 50, 100 freely selectable		
Weighing Units	ct, g, gn, lb, mo, oz, ozt, tl (HK), tl (Singap. Malays), tl (Tw), pen		
Electric Supply	230V/50 Hz (Euro) 9V DC	230V/50 Hz (Euro) 24V AC	
Operating temperature	+ 5° C / + 35° C		
Humidity of air	max. 80 % (not condensing)		
Underfloor weighing	-	Clevis type eyelet, standard	Clevis type eyelet, standard
Housing (B x D x H) mm	210 x 340 x 160		
Windshield [mm]	inside Ø 150, 60 high		
	outside Ø 160, 70 high		
Weighing plate (stainless steel)	Ø 11 cm		
Weight kg (net)	4 kg	4.5 kg	4.5 kg
Interface	RS 232C		

KERN	PLJ 2000-3A	PLJ 4200-2F	PLJ 6200-2A
Weighing range (max)	2100 g	4200 g	6200 g
Readability (d)	0.001 g	0.01 g	0.01 g
Reproducibility	0.002 g	0.02 g	0.01 g
Linearity	± 0.004 g	± 0.04 g	± 0.03 g
Stabilization time (typical)	2 sec.	2 sec.	2 sec.
Minimum unit weight at piece counting under laboratory conditions *	50 mg	50 mg	10 mg
Minimum unit weight at piece counting under normal conditions **	500 mg	500 mg	100 mg
Warm-up time	8 h	4 h	4 h
Adjustment weight	internal		
Reference quantities at piece counting	10, 25, 50, 100 freely selectable		
Weighing Units	ct, g, gn, lb, mo, oz, ozt, tl (HK), tl (Singap. Malays), tl (Tw), pen		
Electric Supply	230V/50 Hz (Euro) 24 V AC	230V/50 Hz (Euro) 9V DC	230V/50 Hz (Euro) 24 V AC
Operating temperature	+ 5° C + 35° C		
Humidity of air	max. 80 % (not condensing)		
Underfloor weighing	Clevis type eyelet, standard	-	Clevis type eyelet, standard
Housing (B x D x H) mm	210 x 340 x 160	210 x 340 x 100	210 x 340 x 100
Windshield mm inside Ø 150, 60 high outside Ø 160, 70 high	yes	no	no
Weighing plate (stainless steel)	Ø 16 cm	Ø 16 cm	Ø 16 cm
Weight kg (net)	4.5 kg	4.5 kg	5 kg
Interface	RS 232C		

KERN	PLJ 720-3AM	PLJ 6200-2AM
Product No / Type	TPLJ 720-3BM-A	TPLJ 6200-2BM-A
Weighing range (max)	720 g	6200 g
Readability (d)	0.001 g	0.01 g
Reproducibility	0.001 g	0.01 g
Linearity	± 0.002 g	± 0.02 g
Verification value (e)	10 mg	100 mg
Verification class	II	II
Minimum load (Min)	20 mg	50 mg
Stabilization time (typical)	2 sec.	2 sec.
Minimum unit weight at piece counting under laboratory conditions *	1 mg	10 mg
Minimum unit weight at piece counting under normal conditions **	10 mg	100 mg
Warm-up time	4 h	4 h
Adjustment weight	internal	
Reference quantities at piece counting	10, 25, 50, 100, freely selectable	
Weighing Units	ct, g	
Electric Supply	220V – 240 V AC, 50 Hz	
Operating temperature	+ 5° C + 35° C	
Humidity of air	max. 80 % (not condensing)	
Gehäuse (B x T x H) mm	210 x 340 x 100	
Windshield [mm]	inside Ø 150, 60 high	
	outside Ø 160, 70 high	
Weighing plate (stainless steel)	Ø 11 cm	Ø 16 cm
Weight kg (net)	4,5 kg	4.5 kg
Interface	RS 232C	

KERN	PLS 420-3F	PLS 720-3A	PLS 1200-3A
Weighing range (max)	420 g	720 g	1200 g
Readability (d)	0.001 g	0.001 g	0.001 g
Reproducibility	0.002 g	0.001 g	0.001 g
Linearity	± 0.004 g	± 0.002 g	± 0.003 g
Stabilization time (typical)	3 sec.	2 sec.	2 sec.
Minimum unit weight at piece counting under laboratory conditions *	5 mg	5 mg	5 mg
Minimum unit weight at piece counting under normal conditions **	50 mg	50 mg	50 mg
Warm-up time	4 h	4 h	8 h
Adjustment weight	400 g (E2)	600 g (E2)	1 kg (E2)
Reference quantities at piece counting	10, 25, 50, 100, freely selectable		
Weighing Units	ct, g, gn, lb, mo, oz, ozt, tl (HK), tl (Singap. Malays), tl (Tw), pen		
Electric Supply	230V/50 Hz (Euro)9V DC	230V/50 Hz (Euro)24V AC	
Rechargeable battery	Operation period 30 h Loading time 10 h	-	-
Operating temperature	+ 5° C + 35° C		
Humidity of air	max. 80 % (not condensing)		
Underfloor weighing	Clevis type eyelet, standard		
Housing (B x D x H) mm	210 x 340 x 160		
Windshield [mm]	inside Ø 150, 60 high		
	outside Ø 160, 70 high		
Weighing plate (stainless steel)	Ø 11 cm		
Weight kg (net)	4 kg	4.5 kg	4.5 kg
Interface	RS 232C		

KERN	PLS 4200-2F	PLS 6200-2A
Weighing range (max)	4200 g	6200 g
Readability (d)	0.01 g	0.01 g
Reproducibility	0.02 g	0.01 g
Linearity	± 0.04 g	± 0.03 g
Stabilization time (typical)	3 sec.	2 sec.
Minimum unit weight at piece counting under laboratory conditions *	50 mg	50 mg
Minimum unit weight at piece counting under normal conditions **	500 mg	500 mg
Warm-up time	4 h	4 h
Adjustment weight	4 kg (E2)	5 kg (E2)
Reference quantities at piece counting	10, 25, 50, 100, freely selectable	
Weighing Units	ct, g, gn, lb, mo, oz, ozt, tl (HK), tl (Singap. Malays), tl (Tw), pen	
Electric Supply	230V/50 Hz (Euro) 9V DC	230V/50 Hz (Euro) 24V AC
Rechargeable battery	Operation period 30 h Loading time 10 h	-
Rechargeable battery	+ 5° C + 35° C	
Operating temperature	max. 80 % (not condensing)	
Underfloor weighing	Clevis type eyelet, standard	
Housing (B x D x H) mm	210 x 340 x 100	
Windshield	no	
Weighing plate (stainless steel)	Ø 16 cm	
Weight kg (net)	4 kg	4.5 kg
Interface	RS 232C	

KERN	PLS 8000-2A	PLS 20000-1F
Weighing range (max)	8200 g	20 kg
Readability (d)	0.01 g	0.1 g
Reproducibility	0.01 g	0.1 g
Linearity	± 0.03 g	± 0.4 g
Stabilization time (typical)	2 sec.	3 sec.
Minimum unit weight at piece counting under laboratory conditions *	10 mg	500 mg
Minimum unit weight at piece counting under normal conditions **	100 mg	5 g
Warm-up time	4 h	4 h
Recommended adjustment weight, not added (class)	5 kg (E2)	20 kg (E2)
Reference quantities at piece counting	10, 25, 50, 100, freely selectable	
Weighing Units	ct, g, gn, lb, mo, oz, ozt, tl (HK), tl (Singap. Malays), tl (Tw), pen	
Electric Supply	230V/50 Hz (Euro) 24V AC	230V/50 Hz (Euro) 9V DC
Operating temperature	+ 5° C + 35° C	
Humidity of air	max. 80 % (not condensing)	
Underfloor weighing	Clevis type eyelet, standard	
Housing (B x D x H) mm	210 x 340 x 100	210 x 340 x 100
Windshield mm	no	no
Weighing plate (stainless steel)	Ø 16 cm	200 x 175 mm
Weight kg (net)	4.75 kg	4 kg
Interface	RS 232C	

*** Minimum unit weight at piece counting under laboratory conditions:**

- Perfect ambient conditions to perform high resolution counting
- No dispersion of counted parts weight

****Minimum unit weight at piece counting under normal conditions:**

- Unstable ambient conditions (wind gusts, vibrations)
- Dispersion of counted parts weight

2 Declaration of Conformity

To view the current EC/EU Declaration of Conformity go to:

www.kern-sohn.com/ce

- i** The scope of delivery for verified weighing balances (= conformity-rated weighing balances) includes a Declaration of Conformity.

3 Device overview

3.1 Components

Model ALJ 200-5DA

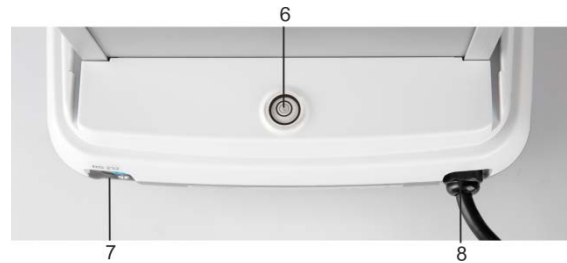

Pos.	Designation
------	-------------

- | | |
|---|----------------------|
| 1 | Glass windshield |
| 2 | Wind protection ring |
| 3 | Display |
| 4 | Keyboard |
| 5 | Foot screw |

Pos.	Designation
------	-------------

- | | |
|---|--------------------------|
| 6 | Bubble level |
| 7 | RS232 |
| 8 | Mains adapter connection |

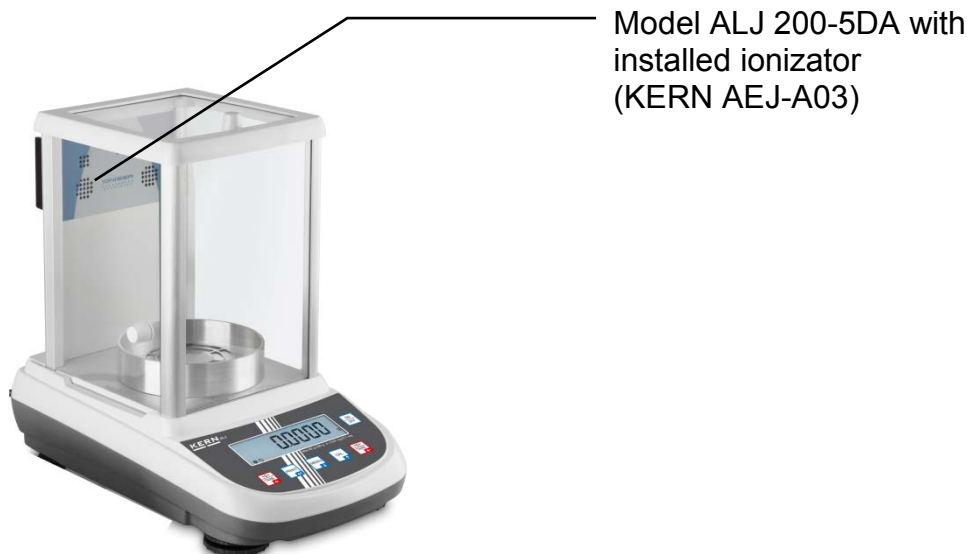

Model ALJ 200-5DA with installed ionizer (KERN AEJ-A03)

Front side of the balances

Model ALJ / ALS / PLJ 2000-3A



Pos.	Designation
------	-------------

- | | |
|---|-------------------|
| 1 | Glass wind screen |
| 2 | Weighing pan |
| 3 | Display |
| 4 | Keyboard |
| 5 | Foot screw |
| 6 | Bubble level |

Models PLJ / PLS: Dimensions weighing plate Ø 110 mm



Pos.	Designation
------	-------------

1	Cover glass wind screen
2	Glass wind screen
3	Weighing plate
4	Display
5	Keyboard
6	Foot screw

Models PLS
Dimensions weighing plate Ø 160 mm



Model PLS 20000-1F
Dimensions weighing plate 200 x 175 mm



English

Pos.	Designation
------	-------------

- | | |
|---|----------------|
| 1 | Bubble level |
| 2 | Weighing plate |
| 3 | Display |
| 4 | Keyboard |
| 5 | Foot screw |

Back and bottom side of the balance

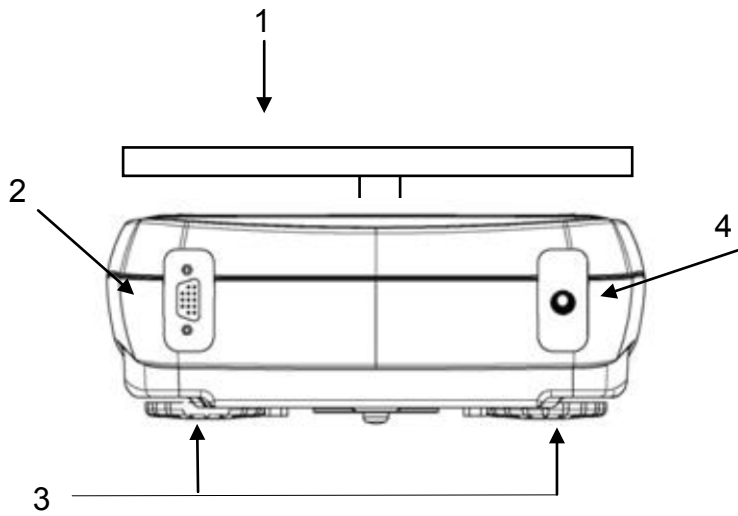

1. Weighing plate
2. RS232C interface
3. Foot screws
4. Mains adapter connection

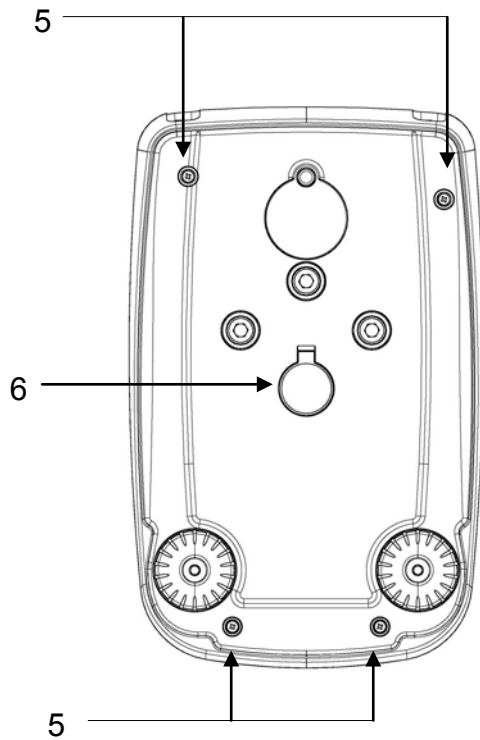

5. Housing screws
(in models with four feet
first screw out the two
rear feet)
6. Underfloor weighing
device

3.2 Operating elements





3.2.1 Overview of display

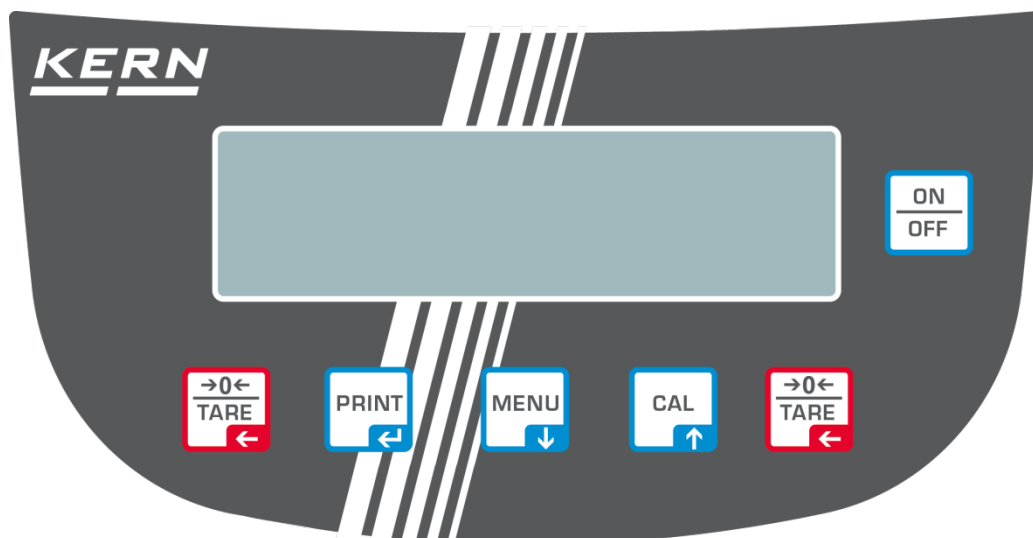

Icon	Designation
*	Stability display
○	Indicator “zero display”
%	Application <Calculation of percentage>
PC	Application <Parts counting>
	Loading status rechargeable battery, see chap. Fehler! Verweisquelle konnte nicht gefunden werden.
▼	Balance is in input mode
H	Upper tolerance limit
L	Lower tolerance limit
DS	Application <Density>
{ }	Brackets to display non verified ciphers (only verified balances)
ct kg mg dwt GN lb ozt	Weighing Units

3.2.2 Keyboard overview



Key	Designation	Short key pressing	Longtime pressed button until the acoustic signal gets mute
	MENU button/	<ul style="list-style-type: none"> • Call-up application menu • Select menu items – scroll forward 	<ul style="list-style-type: none"> • Call-up user menu • Exit user menu
	Arrow button ↓	<ul style="list-style-type: none"> • numerical input – scroll backward 	
	ON/OFF switch	<ul style="list-style-type: none"> • Turn on/off • Exit user menu 	
	CAL button/	<ul style="list-style-type: none"> • Adjustment • Select menu items – scroll backward 	
	Arrow button ↑	<ul style="list-style-type: none"> • Numerical input – scroll forward 	
	PRINT button	<ul style="list-style-type: none"> • Calculate weighing data via interface • Confirm / store settings 	
	Arrow button ←	<ul style="list-style-type: none"> • Numerical input – cipher selection 	
	TARE button	<ul style="list-style-type: none"> • Taring • Zeroing 	

4 Basic Information (General)

4.1 Proper use

The balance you purchased is intended to determine the weighing value of material to be weighed. It is intended to be used as a “non-automatic” balance, i.e. the material to be weighed is manually and carefully placed in the centre of the weighing plate. As soon as a stable weighing value is reached the weighing value can be read.

4.2 Improper Use

Do not use balance for dynamic weighing. In the event that small quantities are removed or added to the material to be weighed, incorrect weighing results can be displayed due to the “stability compensation” in the balance. (Example: Slowly draining fluids from a container on the balance.)

Do not leave permanent load on the weighing plate. This may damage the measuring system. Impacts and overloading exceeding the stated maximum load (max) of the balance, minus a possibly existing tare load, must be strictly avoided. Balance may be damaged by this. Never operate balance in explosive environment. The serial version is not explosion protected.

The structure of the balance may not be modified. This may lead to incorrect weighing results, safety-related faults and destruction of the balance.

The balance may only be used according to the described conditions. Other areas of use must be released by KERN in writing.

4.3 Warranty

Warranty claims shall be voided in case

- Our conditions in the operation manual are ignored
- The appliance is used outside the described uses
- The appliance is modified or opened
- Mechanical damage or damage by media, liquids, natural wear and tear
- The appliance is improperly set up or incorrectly electrically connected
- The measuring system is overloaded

4.4 Monitoring of Test Resources

In the framework of quality assurance the measuring-related properties of the balance and, if applicable, the testing weight, must be checked regularly. The responsible user must define a suitable interval as well as type and scope of this test. Information is available on KERN's home page (www.kern-sohn.com) with regard to the monitoring of balance test substances and the test weights required for this. In KERN's accredited DKD calibration laboratory test weights and balances may be calibrated (return to the national standard) fast and at moderate cost.

5 Basic Safety Precautions

5.1 Pay attention to the instructions in the Operation Manual

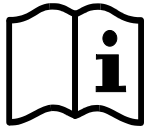

Carefully read this operation manual before setup and commissioning, even if you are already familiar with KERN balances.

Versions in other languages are non-binding translations.
The only binding version is the original document in German.

5.2 Personnel training

The appliance may only be operated and maintained by trained personnel.

6 Transportation & Storage

6.1 Testing upon acceptance

When receiving the appliance, please check packaging immediately, and the appliance itself when unpacking for possible visible damage.

6.2 Packaging / return transport



- ⇒ Keep all parts of the original packaging for a possibly required return.
- ⇒ Only use original packaging for returning.
- ⇒ Prior to dispatch disconnect all cables and remove loose/mobile parts.

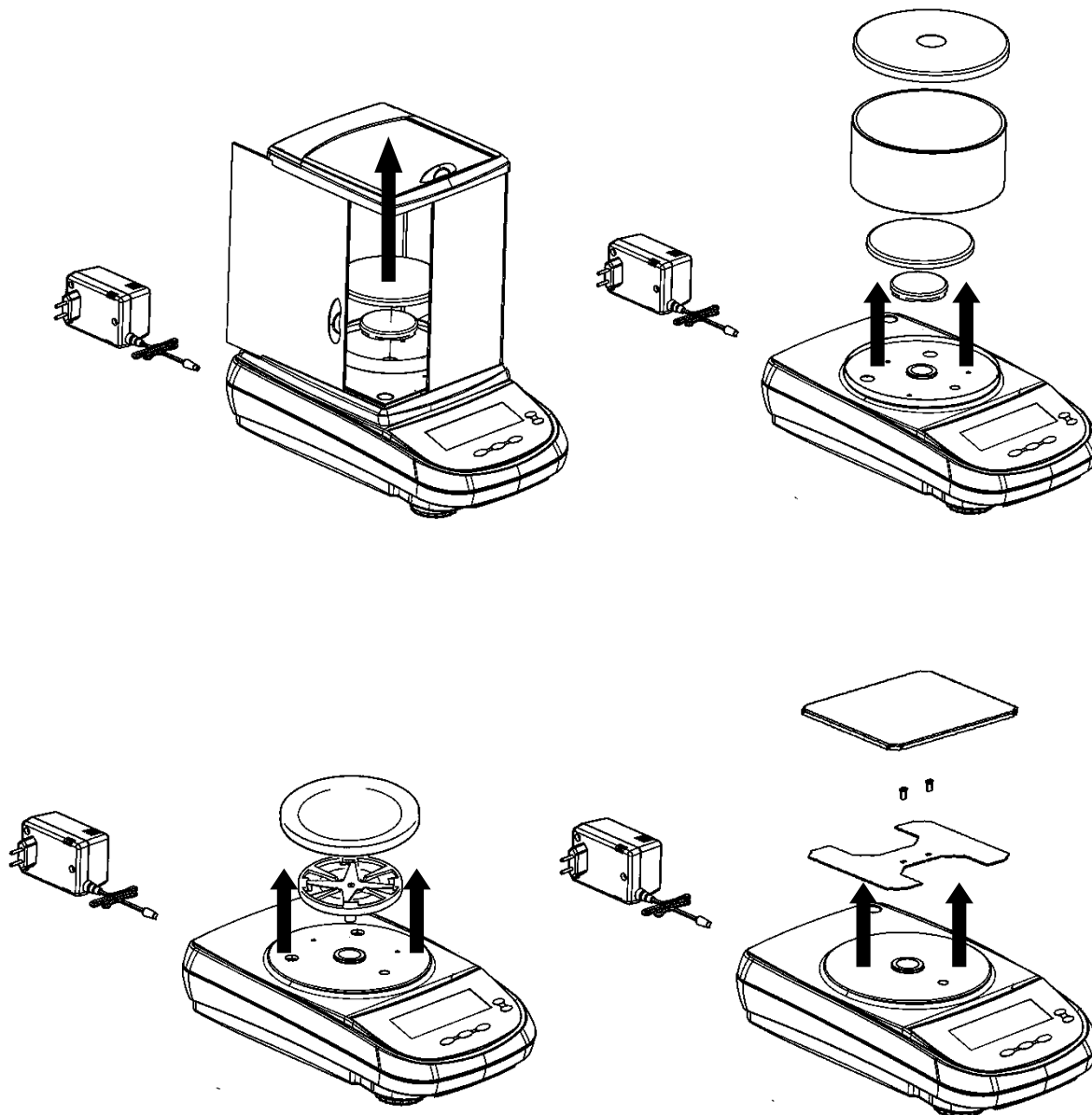

- ⇒ Reattach possibly supplied transport securing devices.
- ⇒ Secure all parts such as the glass wind screen, the weighing platform, power unit etc. against shifting and damage.

Illustration example Analytical balances:

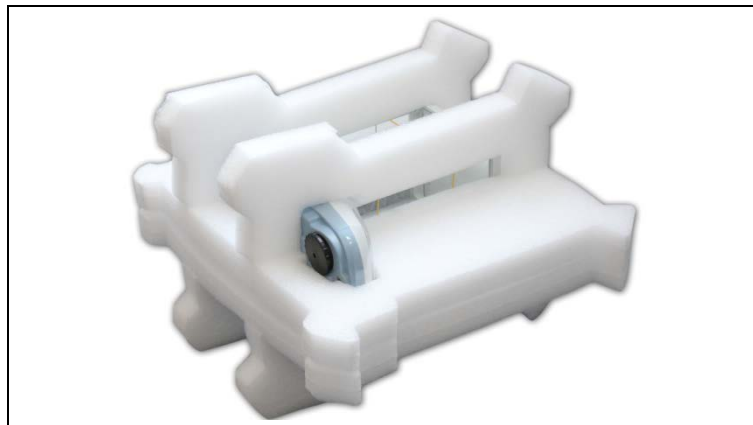
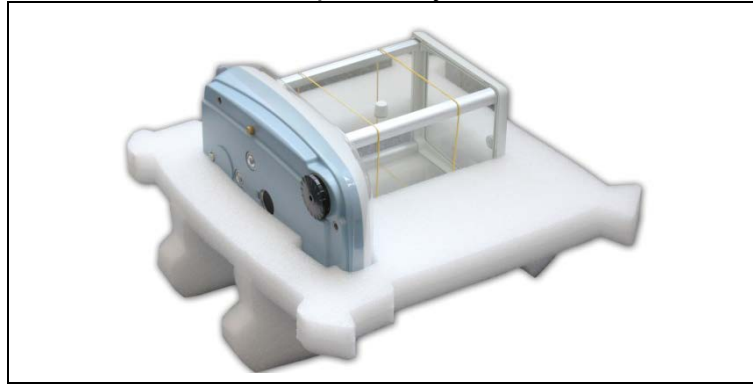

7 Unpacking, Setup and Commissioning

7.1 Installation Site, Location of Use

The balances are designed in a way that reliable weighing results are achieved in common conditions of use.

You will work accurately and fast, if you select the right location for your balance.

Therefore, observe the following for the installation site:

- Place the balance on a firm, level surface;
- Avoid extreme heat as well as temperature fluctuation caused by installing next to a radiator or in the direct sunlight;
- Protect the balance against direct draughts due to open windows and doors;
- Avoid jarring during weighing;
- Protect the balance against high humidity, vapors and dust;
- Do not expose the device to extreme dampness for longer periods of time. Non-permitted condensation (condensation of air humidity on the appliance) may occur if a cold appliance is taken to a considerably warmer environment. In this case, acclimatize the disconnected appliance for ca. 2 hours at room temperature.
- Avoid static charge of goods to be weighed or weighing container.

Major display deviations (incorrect weighing results) may be experienced should electromagnetic fields (e.g. due to mobile phones or radio equipment), static electricity accumulations or instable power supply occur. Change location or remove source of interference.

7.2 Unpacking / placing

Carefully remove the balance from the packaging, remove plastic cover and setup balance at the intended workstation.

Check if that there has been no damage and that all packing items are present.

Scope of delivery / serial accessories

- Balance (see chap. 3.1)
- Mains adapter
- Electronic box (only ALJ 200-5A)
- Operating manual

7.2.1 Placing

i The right place is decisive for the accuracy of the weighing results of high-resolution analytical and precision balances (see chap. **Fehler!** **Verweisquelle konnte nicht gefunden werden.**).

⇒ **Assembly of the balance**

Model ALJ 200-5DA



Insert grid weighing plate



Place wind protection ring



Connect scale to power supply.

Models ALS/ALJ

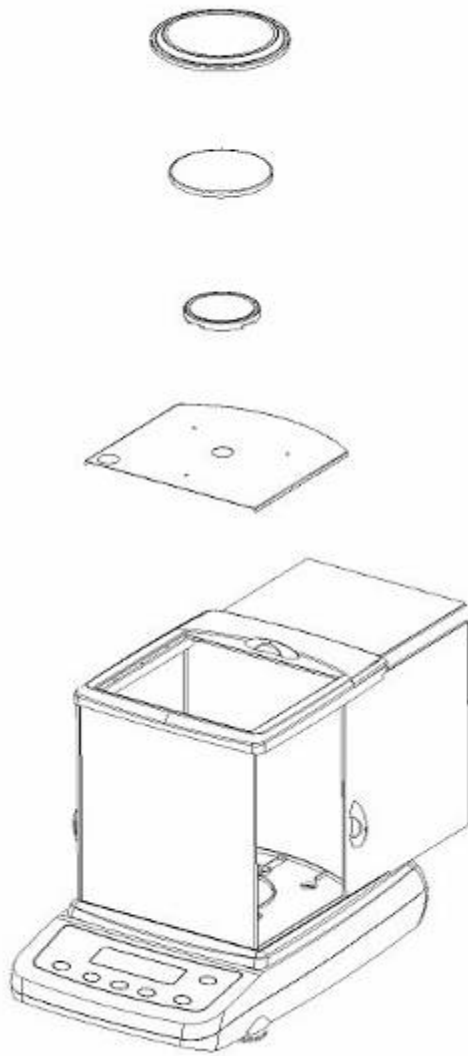

Models PLS/PLJ, d = 1 mg

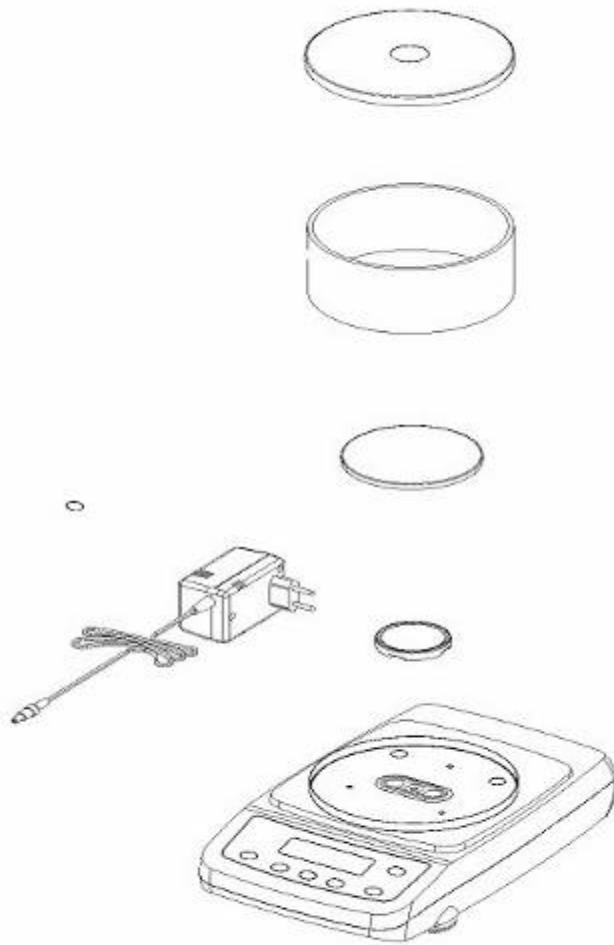

Models PLS/PLJ, d = 100 mg

Models PLS/PLJ, d = 10 mg

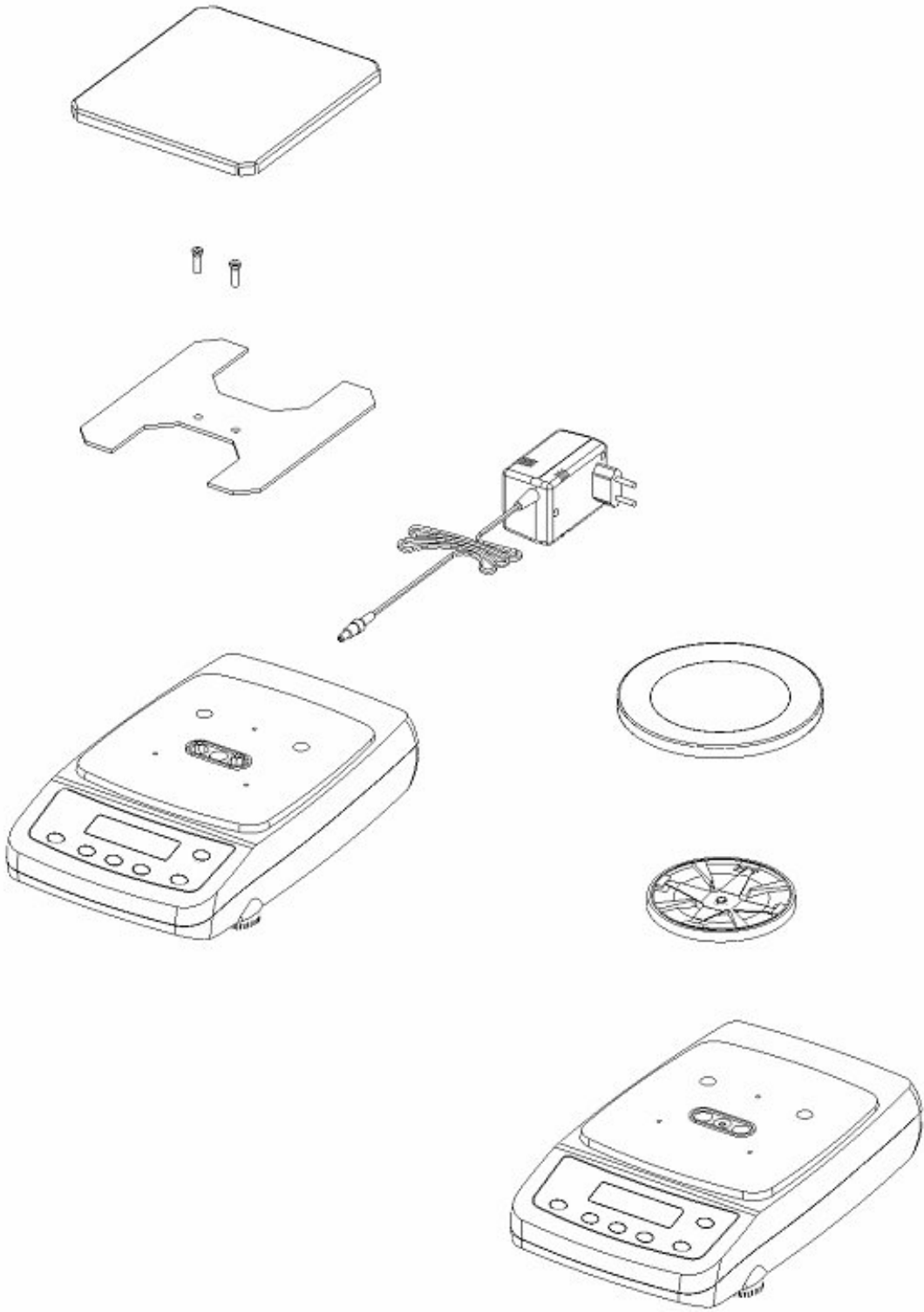

⇒ Levelling

Exact alignment and stable installation are an essential requirement for repeatable results. You can compensate for minor unevenness or tilts of the footprint by levelling the weighing balance.

Level the balance with foot screws [1] until the air bubble in the bubble level is in the prescribed circle. After that lock the foot screws with the washers [2].

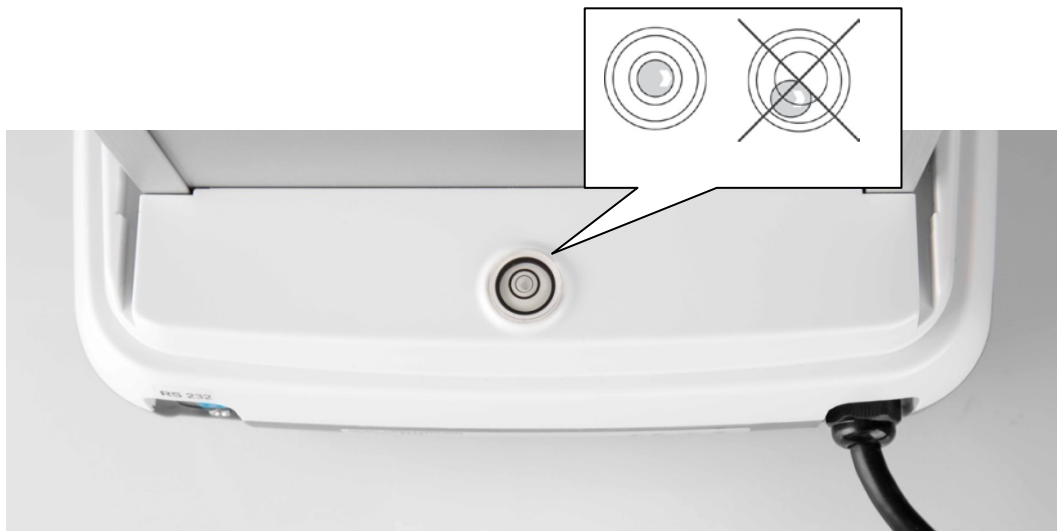

Check levelling regularly

Remove the transportation lock:

On the left lower side of the balance replace the golden-coloured screw with the silver-coloured one (see sticker).



7.3 Mains connection



Select a country-specific power plug and insert it in the mains adapter.



Check, whether the voltage acceptance on the scales is set correctly. Do not connect the scales to the power mains unless the information on the scales (sticker) matches the local mains voltage.

Only use KERN original mains adapter. Using other makes requires consent by KERN.



Important:

- Before starting your weighing balance, check the mains cable for damage.
- Ensure that the power unit does not come into contact with liquids.
- Ensure access to mains plug at all times.



In order to obtain exact results with the electronic balances, your balance must have reached the operating temperature (see warming up time chap. 1). During this warming up time the balance must be connected to the power supply (mains, accumulator or battery). The accuracy of the balance depends on the local acceleration of gravity. Strictly observe hints in chapter Adjustment.

7.4 Connect and switch-on power supply

- ⇒ Connect scale to power supply.
- ⇒ The balance will carry out a self-test Then the balance is set into stand-by mode. The weighing balance will remain switched on as long as it is connected to the power supply. Operate the **ON/OFF**-key to turn on/off the display.

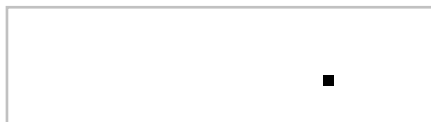



To **turn on** the display, press the **ON/OFF**-key. When the zero display appears, the balance is ready for operation. When weighing with internal adjustment weight, an adjustment first occurs automatically. During this process, „CAL“ will appear on the display.



To **switch off**, press the **ON/OFF** button again. During this process the weighing balance will be moving into ready mode.

The weighing balance will be ready for operation immediately after activation without requiring any time to warm up.

7.5 Rechargeable battery operation (depends on model, see chp.1)

The rechargeable battery is charged via the delivered power supply.

The operating time of the rechargeable battery is about 30h; charging time until complete recharging ca. 10h.

In the menu you can activate the AUTO-OFF function [time off], see chp. 9.8.

According to menu settings, the balance switches automatically off in order to spare the battery.

When the balance is in battery mode the following symbols appear on the display:

	Battery charge sufficient
	Battery very low. Connect mains adapter as soon as possible to load the rechargeable battery.
	Voltage has dropped below prescribed minimum. Connect mains adapter to load the rechargeable battery.

7.6 Connection of peripheral devices

Before connecting or disconnecting of additional devices (printer, PC) to the data interface, always disconnect the balance from the power supply.

With your balance, only use accessories and peripheral devices by KERN, as they are ideally tuned to your balance.

8 Adjustment

As the acceleration value due to gravity is not the same at every location on earth, each balance must be coordinated - in compliance with the underlying physical weighing principle - to the existing acceleration due to gravity at its place of location (only if the balance has not already been adjusted to the location in the factory). This adjustment process must be carried out for the first commissioning, after each change of location as well as in case of fluctuating environment temperature. To receive accurate measuring values it is also recommended to adjust the balance periodically in weighing operation.

- ⇒ Observe stable environmental conditions. A warming up time (see chapter 1) is required for stabilization.
- ⇒ Ensure that there are no objects on the weighing plate.

8.1 Models with external weight (KERN ALS/PLS)



- The adjustment is locked for verified balances.
- Weight value of the required adjustment weight see chpt. 1 “Technical specifications“

8.1.1 Adjustment with recommended adjustment weight (factory setting)



- ⇒ Ensure that there are no objects on the weighing plate. Press the **CAL** key



- ⇒ Wait until the weighed value for the required adjustment weight appears flashing.



- ⇒ **During** the flashing display put the required adjustment weight carefully in the center of the weighing plate.
The flashing display disappears.
After successful adjustment the balance automatically returns to weighing mode.
- ⇒ Take away adjustment weight



8.1.2 Adjustment with weights of other nominal values

Weights of different nominal values may be used for adjustment but are not optimal for technical measuring, possible adjustment points see table 1.

Info about adjustment weights can be found on the Internet at: <http://www.kern-sohn.com>



- ⇒ Ensure that there are no objects on the weighing plate. Press the **CAL** button and keep it pressed until the acoustic signal gets mute.



- ⇒ Wait until „load“ appears.



- ⇒ **During** the flashing display put the adjustment weight carefully in the center of the weighing plate.
The flashing display disappears.
After successful adjustment the balance automatically returns to weighing mode.
- ⇒ Take away adjustment weight



i An error message will be displayed in the event of an adjustment error or incorrect adjustment weight. Wait until the balance is again in weighing mode and repeat the adjustment procedure.

Model	Recommended adjustment weight (see chap. 7.1.1).	Other measurement-technically not optimal nominal values for adjustment (see chap. 7.1.2)
A-models		
ALS 160-4A	150g	100g
ALS 250-4A	200g	100g
PLS 510-3A	500g	100g, 200g, 300g, 400g
PLS 720-3A	600g	100g, 200g, 300g, 400g, 500g
PLS 1200-3A	1000g	-
PLS 1200-3DA	1000g	-
PLS 4200-2A	4000g	1000g, 2000g, 3000g
PLS 6200-2A	5000g	1000g, 2000g, 3000g, 4000g, 6000g
PLS 6200-2DA	5000g	1000g, 2000g, 3000g, 4000g, 6000g
F-models		
PLS 310-3F	300g	100g, 200g
PLS 420-3F	400g	100g, 200g, 300g
PLS 3100-2F	3000g	1000g, 2000g
PLS 4200-2F	4000g	1000g, 2000g, 3000g
PLS 20000-1F	20000g	10 kg

8.2 Models with internal weight (KERN ALJ/PLJ)

For non verified balances four adjustment possibilities are available in the menu.

Menu settings In weighing mode press the **MENU** button and keep it pressed until the acoustic signal gets mute. The first menu item „units“ is displayed.

Press **MENU** button repeatedly until „calib“ appears and confirm using **PRINT** button.

Use the **MENU** key to choose between the following settings:

AUT-CAL Automatic adjustment with internal weight.
Factory settings of models with type approval.

I-CAL Adjustment with internal weight after having pressed CAL; not available for models with settings appropriate for verification.

E-CAL Adjustment with external weight
not available for models with settings appropriate for verification.

TEC-CAL not documented

Take over selection using the **PRINT** button.
The balance returns to menu.

To finish the menu press the **MENU** button and keep it pressed until the acoustic signal gets mute. The balance returns automatically into weighing mode.

AUT-CAL Factory setting of verified balances

With activated AUT-CAL function the internal adjustment is automatically started when the balance

- after the weighing balance was disconnected from the mains
- after pressing **ON/OFF** in stand-by mode
- after a temperature change of 1.5 °C
with non loaded weighing plate / zero display
- after a time interval of 3 hours
with non loaded weighing plate / zero display

The automatic adjustment function is always enabled. You can start adjustment at any time by pressing the **CAL**-key manually.

I-CAL When the I-CAL function is activated, the internal adjustment is started only by pressing the **CAL** button. Before pressing CAL ensure that there are no objects on the weighing plate.

E-CAL At the models with internal adjustment weight the adjustment with external weight is not recommended.
Procedure see chapter 7.1.

8.2.1 Adjustment models PLJ-M

Menu settings In weighing mode press the **MENU** button and keep it pressed until the acoustic signal gets mute. The first menu item „units“ is displayed.
Press **MENU** button repeatedly until „calib“ appears and confirm using **PRINT** button.

Use the **MENU** key to choose between the following settings:

AUT-CAL Automatic adjustment with internal weight.
Factory setting for models with type approval.

Take over selection using the **PRINT** button.
The balance returns to menu.

To finish the menu press the **MENU** button and keep it pressed until the acoustic signal gets mute. The balance returns automatically into weighing mode.

8.2.2 Overwrite internal adjustment weight

(Models with settings not appropriate for verification only)

- ⚠ Overwriting is restricted to specialist staff possessing well acquainted with the workings of weighing scales.



* O 0.000 g

- ⇒ Press the **MENU** button and keep it pressed until the acoustic signal gets mute.



Units

- ⇒ Press the **MENU** button as often as required until „CALib“ appears
⇒ Operate the **PRINT** key
⇒ Press the **MENU** button as often as required until „TEC-CAL“ appears



TECCAL

- ⇒ Press the **PRINT** button and keep it pressed until the acoustic signal gets mute.



CALib

- ⇒ Press the **MENU** button and keep it pressed until the acoustic signal gets mute. The balance changes automatically into weighing mode
⇒ Ensure that there is no load on the weighing plate
⇒ Press the **CAL** key



CAL

Wait until the exact value of the adjustment weight will be shown flashing



4000

(Example)

- ⇒ Place the displayed adjusting weight on the weighing plate. The flashing display extinguishes and the balance changes into weighing mode.
⇒ Remove adjustment weight from weighing plate
⇒ Press the **PRINT** button and keep it pressed until the acoustic signal gets mute. The calibrating process is started
During this process „tEc MEM“ is displayed

After having automatically saved the value of the internal adjustment weight, the balance will return into weighing mode.

- ⇒ Carry out the adjustment process as described in chapter 8.2

8.3 Verification

General introduction:

According to EU directive 2014/31EU balances must be verified if they are used as follows (legally controlled area):

- a) For commercial transactions if the price of goods is determined by weighing.
- b) For the production of medicines in pharmacies as well as for analyses in the medical and pharmaceutical laboratory.
- c) For official purposes.
- d) For manufacturing final packages.

In cases of doubt, please contact your local trade in standard.

Verification instructions

An EU type approval exists for balances described in their technical data as verifiable. If a balance is used where obligation to verify exists as described above, it must be verified and re-verified in regular intervals.

Re-verification of a balance is carried out according to the respective national regulations. The validity for verification of balances in Germany is e.g. 2 years.

The legal regulation of the country where the balance is used must be observed!

After verification the balance is sealed at the indicated positions.

Verification of the balance is invalid without the "seal".

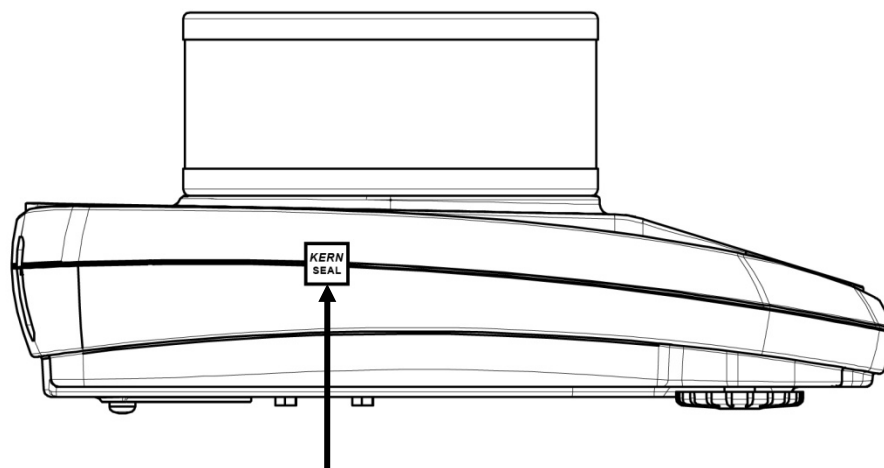

Position of the seal mark (models PLJ)

Balances with obligation to verify must be taken out of operation if:

- ⇒ **The weighing result of the balance is outside the error limit.**
Therefore, in regular intervals load balance with known test weight (ca. 1/3 of the max. load) and compare with displayed value.
- ⇒ **The reverification deadline has been exceeded.**



9 Basic Operation

Start-up

In stand-by mode (see chap. 6.5) press ON/OFF button.
The balance is ready for weighing when the weight display appears.



For models PLJ-M "Wait 30" appears on the display. The weighing balance requires 30 minutes to reach stabilisation. Afterwards it will automatically change into weighing mode at which point it will be ready for operation.

Switching Off

Press ON/OFF button, the balance returns to the stand-by mode (see chap. 6.5).

Simple weighing

- ⇒ Place goods to be weighed on balance
- ⇒ Wait until the stability display appears [*]

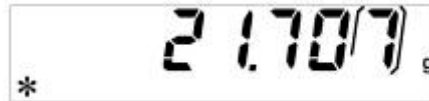

- ⇒ Read weighing result.

Taring

- ⇒ Place the weighing box and press the **TARE** button.
„0-t“ is displayed.

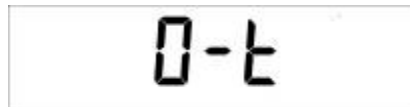

- ⇒ After standstill control the zero display appears.



The weight of the container is now internally saved.

- ⇒ Weigh the material, the net weight will be indicated.
The weight of the weighing container will be displayed as a minus number after removing the weighing container.
The tare weight is saved until it is deleted. Remove the load from the balance and press the **TARE** button. „0-t“ is displayed, wait until the zero display appears.

The tare procedure can be repeated as many times as necessary, for example with initial weighing of several components for a mix (add-on weighing). The limit is reached when the total weighing range capacity is full.

9.1 Underfloor weighing

Objects unsuitable for placing on the weighing scale due to size or shape may be weighed with the help of the flush-mounted platform.

Proceed as follows:

- Switch off the balance
- Open closing cover (1) at the balance bottom.
- Suspend hook for underfloor weighing **carefully and completely**.
- Place weighing balance over an opening.
- Attach load to hook and carry out weighing procedure.

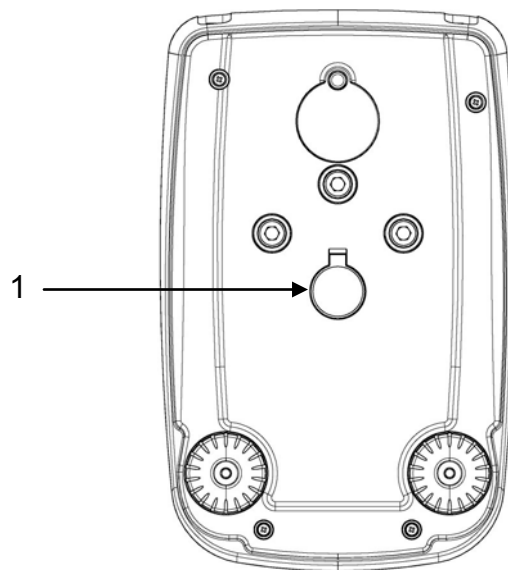

Fig. 1: Setup of balance for underfloor weighing



- Always ensure that all suspended objects are stable enough to hold the desired goods to be weighed safely (danger of breaking).
- Never suspend loads that exceed the stated maximum load (max) (danger of breaking)
- Always ensure that there are no persons, animals or objects that might be damaged underneath the load.



After completing the underfloor weighing the opening on the bottom of the balance must always be closed (dust protection).

10 User menu

The settings of the balance can be changed in the user menu. This way, the balance can be adjusted to individual weighing requirements.

By the factory the user menu has been set in a way that normally no more changes must be made, only at special conditions of use.

Navigation in the menu

Access to menu	In weighing mode press the MENU button and keep it pressed until the acoustic signal gets mute. The first menu item „units“ is displayed.
How to select menu items	Using the MENU button the individual menu items can be selected one after the other. ⇒ Scroll forward using MENU button ⇒ Scroll backward using CAL button
Change settings	Acknowledge selected menu item using PRINT button, the current setting is displayed. Each time the arrow buttons ↓ ↑ are pressed the next setting will be displayed. ⇒ Scroll forward using MENU button ⇒ Scroll backward using CAL button
Save settings	Take over selection using the PRINT button. Weighing balance returns to menu. Either make more settings in the menu or go back to menu mode as follows.
Exit menu/ back to weighing mode	Press the MENU button and keep it pressed until the acoustic signal gets mute. The balance returns automatically into weighing mode.

Menu overview

Menu item	Display	Selection	Description
Weighing unit (see chap. 11.1)	Units	Gram	Gramm
		* Carat	Carat
		* Ounce	Unze
		* Pound	Pound
		* PEnn	Pennyweight
		* OuncEtr	Troy Unze
		* GrAin	Grain
		* tAEL Hon	Tael Hongkong
		* tAEL SGP	Tael Singapore
		* tAEL roc	Tael R.O.C.
		* Momme	Momme
Data output type (see chap. 11.2)	PC-Prtr	PC cont	Continuous output
		Pr CMd	<ul style="list-style-type: none"> • Manual issue after pressing the PRINT button • Mode for remote control commands
		tIP50	not documented
		Print	not documented
Baudrate (see chap. 11.3)	baud rt	br 1200	
		br 2400	
		br 4800	
		br 9600	
Auto zero (see chap. 11.4)	Auto 0	Au0 OFF	Auto Zero switched off
		Au0 1	Auto Zero range $\pm \frac{1}{2}$ digit
		Au0 2	Auto Zero range ± 3 digits (not available at PLJ-M)
		Au0 3	Auto Zero range ± 7 digits (not available at PLJ-M)
		Au0 3E	Auto Zero range ± 7 digits in the whole weighing range (not available at PLJ-M)
Filter (see chap. 11.5)	Filter	Filt 1	Setting for dispensing
		Filt 2	Sensitive and fast, very quiet set-up location
		Filt 3	Robust but slow, busy set-up locatio

Standstill control display (see chap. 11.6)	Stabil	Stab 1	Standstill control fast – very quiet set-up location
		Stab 2	Standstill control fast + exact – quiet set-up location
		Stab 3	Standstill control exact – very set-up location
Contrast of the display (see chap. 11.7)	Contr	1-15	Select contrast
Backlight (see chap. 11.8)	Blt	on	Backlight on
		off	Backlight off
		Auto	Backlight automatically switched off 3 seconds after achieving stable weighing value. Changes in weight or pressing of keys will automatically result in backlight switching on again.
AUTO OFF in stand-by mode (see chap. 11.9)	time off	disab	AUTO-OFF off
		2 Min	AUTO-OFF after 2 minutes without changing the weight
		5 Min	AUTO-OFF after 5 minutes without changing the weight
		15 Min	AUTO-OFF after 15 minutes without changing the weight
Tablet mode	tbl mode	*tbl off	Not documented
		*tbl on	
Adjustment (see chap. 7)	Calib	*E-Cal	Adjustment with external weight, locked for verifiable units
		*Tec Cal	not documented
		*Aut Cal	Automatic adjustment with internal weight.
		*I-Cal	Adjustment with internal weight after having pressed CAL, locked in verifiable units.
	End		

* = not available in all models

10.1 Weighing unit

According to requirements the balance can be switched-over into different units (in verified balances not all the units are available, see chap. 1 „Technical specifications). Selected weighing unit will be retained even after disconnection from the mains.

- ⇒ In weighing mode press the **MENU** button and keep it pressed until the acoustic signal gets mute. The first menu item „units“ is displayed.

- ⇒ Acknowledge using **PRINT** button, the current setting is displayed.

- ⇒ Press the arrow keys **↓** **↑** to select desired setting.

Scroll forward using **MENU** button

Scroll backward using **CAL** button

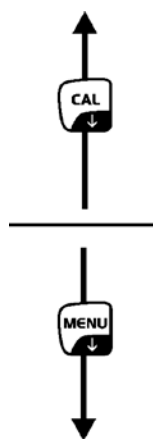

Symbol	Weighing unit	Conversion factor 1g =
Gram	GRAMS	1.
* Carat	CARATS	5.
* Ounce	OUNCE	0.035273962
* Pound	POUNDS	0.0022046226
* PEnn	PENNYWEIGHTS	0.643014931
* OuncEtr	OUNCE TROY	0.032150747
* GrAin	GRAIN	15.43235835
* tAEL Hon	HONG KONG T AEL	0.02671725
* tAEL SGP	SYNGAPORE T AEL	0.02646063
* tAEL roc	R.O.C. T AEL	0.02666666
* Momme	MOMME	0.2667

* not available in all models

- ⇒ Take over selection using the **PRINT** button.
Weighing balance returns to menu. Either make more settings in the menu or go back to weighing mode as follows.
- ⇒ Press the **MENU** button and keep it pressed until the acoustic signal gets mute.
The balance returns automatically into weighing mode.

10.2 Data output type

- ⇒ In weighing mode press the **MENU** button and keep it pressed until the acoustic signal gets mute.

The LCD display shows the word "Units" in a seven-segment font.

- ⇒ Press **MENU** button

The LCD display shows "Pr-Prtr" in a seven-segment font.

- ⇒ Acknowledge using **PRINT** button, the current setting is displayed.

- ⇒ Press the arrow keys **↓** **↑** to select desired setting.

Scroll forward using **MENU** button

Scroll backward using **CAL** button

The LCD display shows "PC Cont" in a seven-segment font.



The LCD display shows "Pr CMd" in a seven-segment font.



The LCD display shows "Pr int" in a seven-segment font.

„PC cont“ = Continuous output

„Pr CMd“ = Manual issue after pressing the **PRINT** button /
Mode for remote control commands

„Print“ = not documented

- ⇒ Take over selection using the **PRINT** button.
Weighing balance returns to menu. Either make more settings in the menu or go back to weighing mode as follows.

- ⇒ Press the **MENU** button and keep it pressed until the acoustic signal gets mute.
The balance returns automatically into weighing mode.

The LCD display shows "0.0000" followed by a small "g" for grams. To the left of the display, there is a small asterisk and a circle symbol (*O).

10.3 Baud rate

- ⇒ In weighing mode press the **MENU** button and keep it pressed until the acoustic signal gets mute.

A rectangular box containing the text 'Units' in a digital font.

- ⇒ Press **MENU** button repeatedly

A rectangular box containing the text 'bAud rt' in a digital font.

- ⇒ Acknowledge using **PRINT** button, the current setting is displayed.

- ⇒ Press the arrow keys **↓** **↑** to select desired setting.

Scroll forward using **MENU** button

Scroll backward using **CAL** button

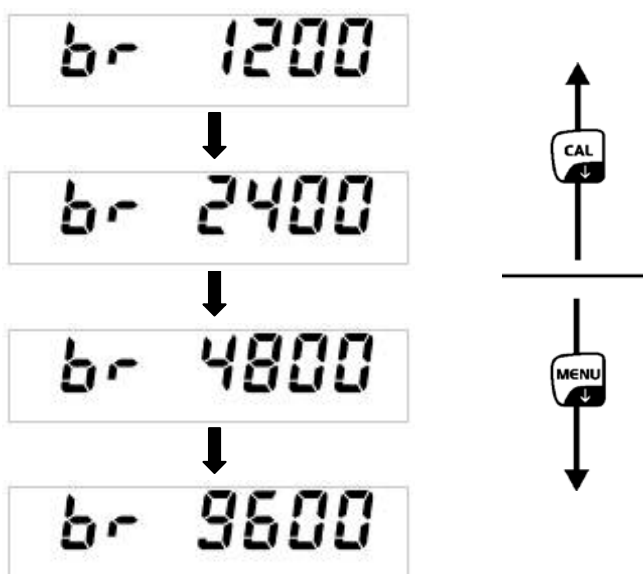

- ⇒ Take over selection using the **PRINT** button.
Weighing balance returns to menu. Either make more settings in the menu or go back to weighing mode as follows.

- ⇒ Press the **MENU** button and keep it pressed until the acoustic signal gets mute.
The balance returns automatically into weighing mode.

A rectangular box containing the text '* O' on the left and '0.000 g' on the right in a digital font.

10.4 Auto Zero

Under this menu item the automatic zero point correction can be switched on or off. In switched-on-state the zero point is automatically corrected at drift or when dirty.

Information:

In the event that small quantities are removed or added to the material to be weighed, incorrect weighing results can be displayed due to the “stability compensation“ in the balance. (e.g. slow flow of liquids from a container placed on the balance, evaporating processes).

When apportioning involves small variations of weight, it is advisable to switch off this function.

- ⇒ In weighing mode press the **MENU** button and keep it pressed until the acoustic signal gets mute.

A rectangular digital display showing the word "Units" in a pixelated font.

- ⇒ Press **MENU** button repeatedly

A rectangular digital display showing the text "Auto 0" in a pixelated font.

- ⇒ Acknowledge using **PRINT** button, the current setting is displayed.

- ⇒ Press the arrow keys **↓** **↑** to select desired setting.
- Scroll forward using **MENU** button
- Scroll backward using **CAL** button

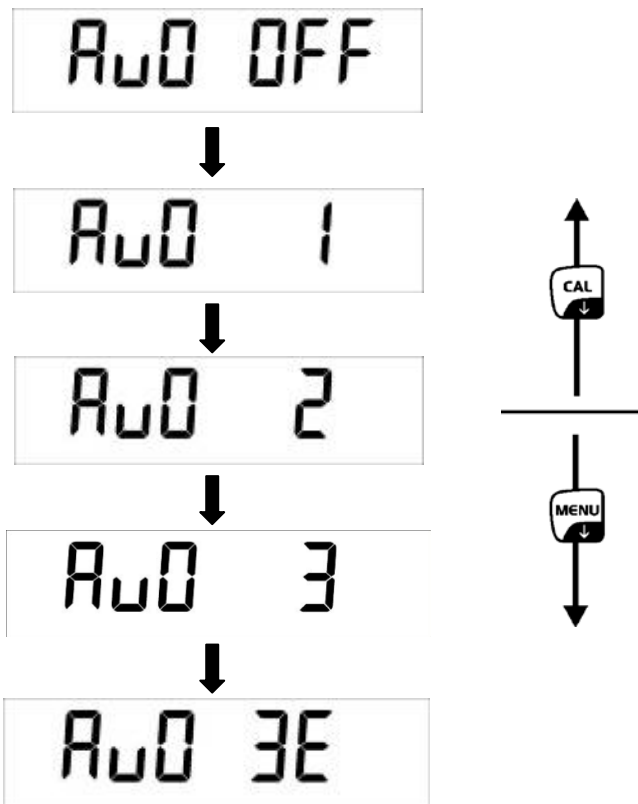

- Au0 OFF** = Auto Zero switched off
- Au0 1** = Auto Zero range $\pm \frac{1}{2}$ digit
- Au0 2** = Auto Zero range ± 3 digits
- Au0 3** = Auto Zero range ± 7 digits
- Au0 3E** = Auto Zero range ± 7 digits in the whole weighing range

- ⇒ Take over selection using the **PRINT** button. Weighing balance returns to menu. Either make more settings in the menu or go back to weighing mode as follows.
- ⇒ Press the **MENU** button and keep it pressed until the acoustic signal gets mute. The balance returns automatically into weighing mode.

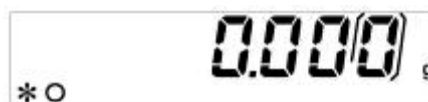

For models PLJ_M settings are restricted to “Au0 OFF” and „Au0 1“

10.5 Filter

This menu item allows the balance to be set according to specific ambient conditions and measuring purposes.

- ⇒ In weighing mode press the **MENU** button and keep it pressed until the acoustic signal gets mute.

A rectangular digital display showing the word "Units" in a seven-segment font.

- ⇒ Press **MENU** button repeatedly

A rectangular digital display showing "F, lter" in a seven-segment font.

- ⇒ Acknowledge using **PRINT** button, the current setting is displayed.

- ⇒ Press the arrow keys **↓** **↑** to select desired setting.

Scroll forward using **MENU** button

Scroll backward using **CAL** button

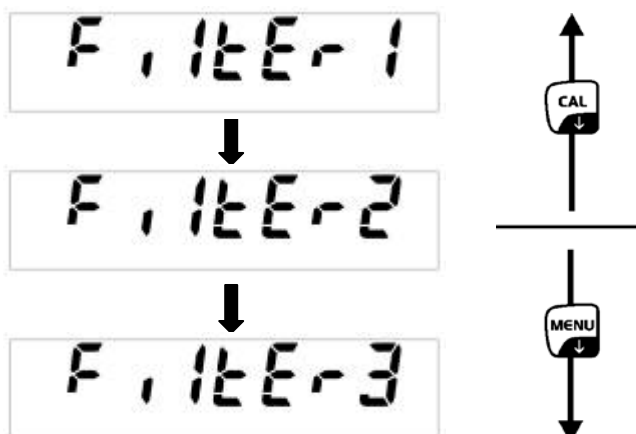

FILTER 1: Setting for dispensing

FILTER 2: Sensitive and fast, very quiet set-up location.

FILTER 3: Robust but slow, busy set-up location.

- ⇒ Take over selection using the **PRINT** button.
Weighing balance returns to menu. Either make more settings in the menu or go back to weighing mode as follows.

- ⇒ Press the **MENU** button and keep it pressed until the acoustic signal gets mute.
The balance returns automatically into weighing mode.

A rectangular digital display showing "0.000" in a seven-segment font, with a small "g" to the right. A "* O" is visible in the bottom left corner of the display area.

10.6 Standstill control display

- ⇒ In weighing mode press the **MENU** button and keep it pressed until the acoustic signal gets mute.

A rectangular digital display showing the word "Units" in a large, black, dot-matrix font.

- ⇒ Press **MENU** button repeatedly

A rectangular digital display showing the text "STAB IL" in a large, black, dot-matrix font.

- ⇒ Acknowledge using **PRINT** button, the current setting is displayed.

- ⇒ Press the arrow keys **↓** **↑** to select desired setting.

Scroll forward using **MENU** button

Scroll backward using **CAL** button

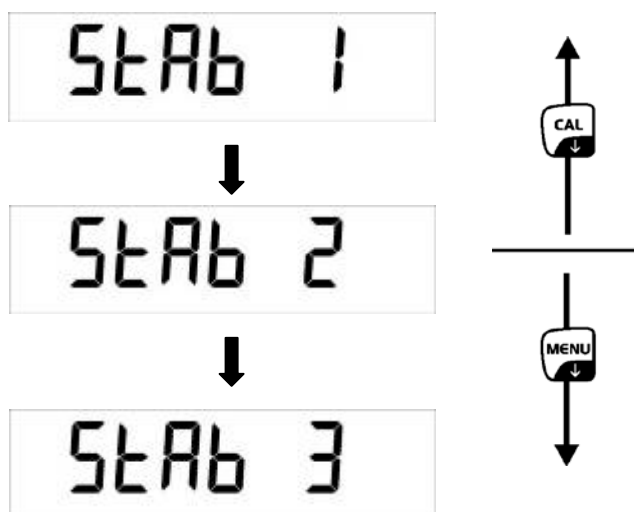

STAB 1: Standstill control fast – very quiet set-up location

STAB 2: Standstill control fast + exact – quiet set-up location

STAB 3: Standstill control exact – very set-up location.

- ⇒ Take over selection using the **PRINT** button.
Weighing balance returns to menu. Either make more settings in the menu or go back to weighing mode as follows.

- ⇒ Press the **MENU** button and keep it pressed until the acoustic signal gets mute.
The balance returns automatically into weighing mode.

A rectangular digital display showing "0.000" in a large, black, dot-matrix font, with a small "g" to its right. Below the "0.000" is a smaller "* O" symbol.

10.7 Setting the contrast of the display

To set the contrast of the display you can choose between 15 values.

- ⇒ In weighing mode press the **MENU** button and keep it pressed until the acoustic signal gets mute.

A rectangular box containing the text 'Units' in a digital font.

- ⇒ Press **MENU** button repeatedly

A rectangular box containing the text 'Contr' in a digital font.

- ⇒ Acknowledge using **PRINT** button, the current setting is displayed.

- ⇒ Press the arrow keys **↓** **↑** to select desired setting.

Scroll forward using **MENU** button

Scroll backward using **CAL** button

A rectangular box containing the text '-01-' in a digital font.



A rectangular box containing the text '-08-' in a digital font.



A rectangular box containing the text '-15-' in a digital font.

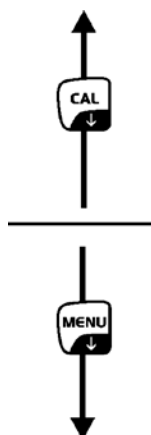

01: small contrast

08: medium contrast

15: high contrast

- ⇒ Take over selection using the **PRINT** button.
Weighing balance returns to menu. Either make more settings in the menu or go back to weighing mode as follows.

- ⇒ Press the **MENU** button and keep it pressed until the acoustic signal gets mute.
The balance returns automatically into weighing mode.

A rectangular box containing the text '* O' on the left and '0.0000 g' on the right in a digital font.

10.8 Display background illumination

⇒ In weighing mode press the **MENU** button and keep it pressed until the acoustic signal gets mute.

Units

⇒ Press **MENU** button repeatedly

bLk

⇒ Acknowledge using **PRINT** button, the current setting is displayed.

⇒ Press the arrow keys **↓** **↑** to select desired setting.

Scroll forward using **MENU** button

Scroll backward using **CAL** button

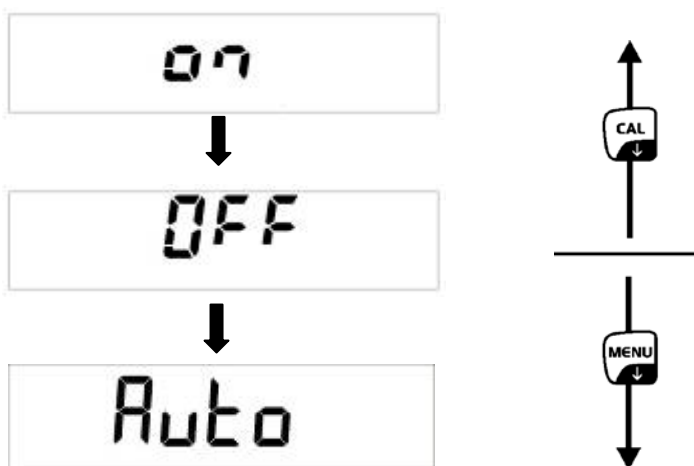

ON Background illumination on

OFF Background illumination off

Auto Backlighting automatically switched off 3 seconds after achieving stable weighing value. Changes in weight or pressing of keys will automatically result in backlight switching on again.

⇒ Take over selection using the **PRINT** button. Weighing balance returns to menu. Either make more settings in the menu or go back to weighing mode as follows.

⇒ Press the **MENU** button and keep it pressed until the acoustic signal gets mute. The balance returns automatically into weighing mode.

*O 0.000 g

10.9 Automatic switch-off function „AUTO OFF“ in stand-by mode

- ⇒ In weighing mode press the **MENU** button and keep it pressed until the acoustic signal gets mute.

Units

- ⇒ Press **MENU** button repeatedly

t ME OFF

- ⇒ Acknowledge using **PRINT** button, the current setting is displayed.
- ⇒ Press the arrow keys **↓** **↑** to select desired setting.

Scroll forward using **MENU** button

Scroll backward using **CAL** button

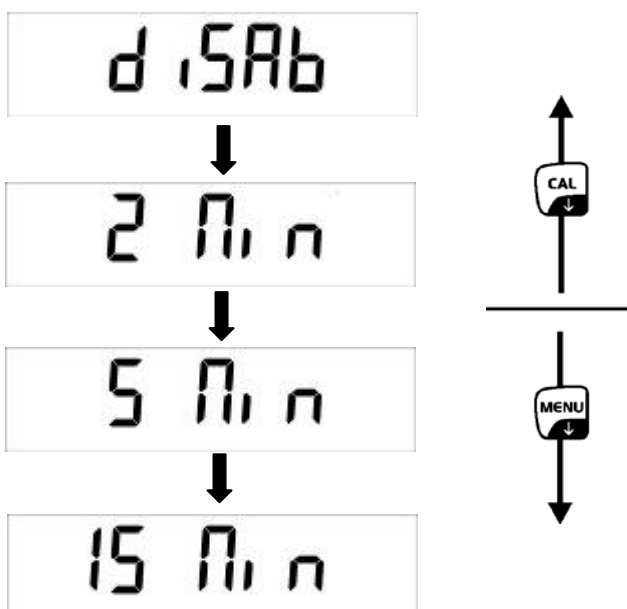

disab = AUTO-OFF switched off

2 Min = AUTO-OFF after 2 minutes without changing the weight

5 Min = AUTO-OFF after 5 minutes without changing the weight

15 Min = AUTO-OFF after 15 minutes without changing the weight

- ⇒ Take over selection using the **PRINT** button.
Weighing balance returns to menu. Either make more settings in the menu or go back to weighing mode as follows.
- ⇒ Press the **MENU** button and keep it pressed until the acoustic signal gets mute.
The balance returns automatically into weighing mode.

* 0 0.0000 g

11 User menu

The following operating modes may be enabled/disabled in the user menu:

Count	Parts counting
↓	
Dens	Density determination of solids/liquids
↓	
Add	Adding function
↓	
HoL	Checkweighing
↓	
Perc	Percent determination
↓	
Anim	Animal weighing function
↓	
M Load	Peak value function
↓	
End	

Navigation in the menu

Access to menu	In weighing mode press MENU button. The first menu item „count“ is displayed.
How to select menu items	Using the MENU button the individual menu items can be selected one after the other. ⇒ Scroll forward using MENU button ⇒ Scroll backward using CAL button
Change settings	Acknowledge selected menu item using PRINT button, the current setting is displayed. Each time the arrow buttons ↓ ↑ are pressed the next setting will be displayed. ⇒ Scroll forward using MENU button ⇒ Scroll backward using CAL button
Save settings	Take over selection using the PRINT button. Weighing balance returns to menu. Either make more settings in the menu or go back to menu mode as follows.
Exit menu/ back to weighing mode	Press the MENU button and keep it pressed until the acoustic signal gets mute. The balance returns automatically into weighing mode.

11.1 Parts counting

Before the balance can count parts, it must know the average part weight (i.e. reference). Proceed by putting on a certain number of the parts to be counted. The balance determines the total weight and divides it by the number of parts, the so-called reference quantity. Counting is then carried out on the basis of the calculated average piece weight.

As a rule:

The higher the reference quantity the higher the counting exactness.

⇒ In weighing mode press **MENU** button. The first menu item „count“ is displayed.

A rectangular display box containing the word "Count" in a large, black, monospace-style font.

⇒ Acknowledge using **PRINT** button, the current reference quantity is displayed.

A rectangular display box containing the text "SNPL 10" in a large, black, monospace-style font.

⇒ Using the arrow buttons **↓** **↑** select reference quantity (10, 25, 50, 100 or manual = numerical input of the reference weight, see chap. 10.1.3).

Scroll forward using **MENU** button

Scroll backward using **CAL** button

⇒ If using a weighing container, put this before pressing the **PRINT** button. The taring process is automatically started. „0-t“ is displayed.

A rectangular display box containing the text "0-t" in a large, black, monospace-style font.

⇒ Confirm selected reference number of items by pressing the **PRINT** button.

A rectangular display box containing the text "LoAd 10" in a large, black, monospace-style font.

⇒ Place as many pieces to add-up as required by the set reference piece number.

⇒ Acknowledge using **PRINT** button and wait for standstill control.

After successful reference determination the current quantity is displayed.

A rectangular display box containing the text "* PC 10" in a large, black, monospace-style font.

⇒ Remove reference weight. The balance is now in parts counting mode counting all units on the weighing plate.



If it was impossible to determine a reference due to instable goods to be weighed or an insufficient reference weight, the following display will appear during reference calculation.

- ⇒ **ERR04** = smallest counting weight not achieved
- ⇒ **Add SMP**=if the placed quantity for a correct reference determination is too small, more parts must be placed as follows.



- ⇒ Place more parts, but at least the double quantity.
- ⇒ Press the **PRINT** button, the reference weight is calculated anew.



The placed quantity is always too small, add more parts and acknowledge using the **PRINT** button. Repeat the procedure until the piece counter display appears.



Placed quantity sufficient for reference determination. Remove reference weight. The balance is now in parts counting mode counting all units on the weighing plate.

Return to weighing mode

- ⇒ Press the **ON/OFF** key.



11.1.1 Switching over between quantity and weight display

⇒ Place load on pan and read the number of pieces.

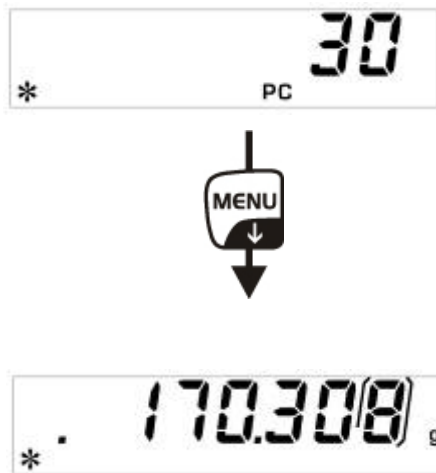

⇒ Press **MENU** button, the total weight of the placed parts is displayed.

or

⇒ Press the **MENU** button and keep it pressed until the acoustic signal gets mute, the average weight of a single piece is displayed.

⇒ Back to quantity display press **MENU** button again.

11.1.2 Automatic reference optimization

In order to improve the counting exactness, the reference can be optimised by adding more pieces. At every reference optimisation, the reference weight is calculated anew. As the additional pieces increase the base for the calculation, the reference also becomes more exact.

⇒ Leave the piece number on the weighing plate after setting the reference weight

⇒ Duplicate the number of pieces on the weighing plate and wait until the acoustic signal sounds. The reference weight is calculated anew.

⇒ Either repeat the reference optimisation by adding more pieces (max. 255 pieces) or start the counting process.



The automatic reference optimisation is not active when the reference weight is entered numerically.

11.1.3 Numeric entering of the reference weight

If you know the reference weight/piece you can enter this via the numeric keyboard.

⇒ In weighing mode press **MENU** button. The first menu item „count“ is displayed.

A rectangular digital display showing the word "Count" in a large, black, monospace font.

⇒ Acknowledge using **PRINT** button, the current reference quantity is displayed.

A rectangular digital display showing "SNPL 10" in a large, black, monospace font.

⇒ Press the arrow buttons **↓** **↑** to select the parameters manually.

A rectangular digital display showing the word "MANUAL" in a large, black, monospace font.

⇒ Acknowledge using **PRINT** button

⇒ Press the arrow buttons **↓** **↑** **←** to enter the known reference weight.

⇒ If using a weighing container, put this before pressing the **PRINT** button. The taring process is automatically started. „0-t“ is displayed.

A rectangular digital display showing "0-t" in a large, black, monospace font.

⇒ Place load on pan and read the number of pieces.

A rectangular digital display showing "30" in a large, black, monospace font. To the left of the number is an asterisk (*), and below the number is "PC".

⇒ Press **MENU** button, the total weight of the placed parts is displayed.

A rectangular digital display showing "170.30(8) g" in a large, black, monospace font. To the left of the number is an asterisk (*).

⇒ Back to quantity display press **MENU** button again.

Return to weighing mode

⇒ Press the **ON/OFF** key

A rectangular digital display showing "0.00(0) g" in a large, black, monospace font. To the left of the number is an asterisk (*) and a small circle (o).

11.2 Density determination with the help of an underfloor weighing device

Density is the relationship of weight [g] : volume [cm³]. The weight is determined by weighing the sample in air. The volume results from the ascending force [g] of the sample dipped in a liquid. The density [g/cm³] of that liquid is known (principle of Archimedes).

i The use of an optionally available density determination set facilitates your work when determining the density

Analytical balances	KERN YDB-03
Precision balances [d] = 0.001 g	KERN ALT-A02
Precision balances [d] = 0.01 g	KERN PLT-A01

11.2.1 Density determination of solids

Prepare the balance as follows:

- Switch off the balance
 - Remove the weighing pan and carefully turn over the weighing balance.
 - Screw-in hook for underfloor weighing (option)
 - Place weighing balance over an opening
 - Hook-in the sample support
 - Fill measuring liquid in a vessel e.g. beaker) and temper it.
- ⇒ In weighing mode press **MENU** button. The first menu item „count“ is displayed.

- ⇒ Press **MENU** button

- ⇒ Acknowledge using **PRINT** button, the current setting is displayed.
 ⇒ Using **MENU** button select „d SoLid“

- ⇒ Confirm by pressing the **PRINT** button.

- ⇒ Use the arrow buttons **↓** **↑** **←** to enter density of the measuring fluid.
 ⇒ Confirm input by pressing the **PRINT** button.

- ⇒ The display for weight determination of the "sample in air" appears.



- ⇒ Confirm by pressing the **PRINT** button.
- ⇒ If necessary, tare and put the sample.
- ⇒ Wait until the weight display of the weighing balance has become stable and then press the **PRINT** button. „WEI AIR“ appears flashing.
- ⇒ The display for weight determination of the "sample in the measuring fluid" appears.



- ⇒ Acknowledge using **PRINT** button
- ⇒ Immerse sample holder and tare by pressing the **TARE**-key
- ⇒ Place sample and immerse it
Make sure that the sample holder does not touch the beaker.
- ⇒ Wait until the weight display of the weighing balance has become stable and then press the **PRINT** button. „WEI LIQ“ appears flashing.
- ⇒ The density of the sample is shown



Return to weighing mode

- ⇒ Press the **ON/OFF** key

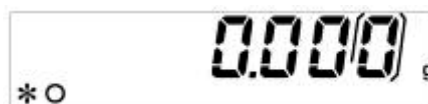

- ⇒ or use the **MENU** button to start a new measuring cycle.

If at the density determination errors have appeared, „d-----“, is displayed.

i



11.2.2 Determining density of liquids

- ⇒ Fill sample liquid into a vessel, e.g. a pitcher.
- ⇒ Heat sample liquid until temperature is constant.
- ⇒ Prepare a glass sinker with known density

- ⇒ In weighing mode press **MENU** button. The first menu item „count“ is displayed.



A digital display showing the word "Count" in a monospaced font.

- ⇒ Press **MENU** button

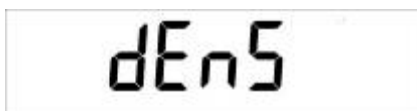

A digital display showing "dEn5" in a monospaced font.

- ⇒ Acknowledge using **PRINT** button, the current setting is displayed.
- ⇒ Using **MENU** button select „d Liquid“



A digital display showing "dL 190 ld" in a monospaced font.

- ⇒ Confirm by pressing the **PRINT** button.



A digital display showing "d5 3.0000" in a monospaced font.

- ⇒ Use the arrow buttons **↓** **↑** **←** to enter density of the glass sinker.
- ⇒ Confirm input by pressing the **PRINT** button.

⇒ The display for weight determination of the "glass sinker in air" appears.

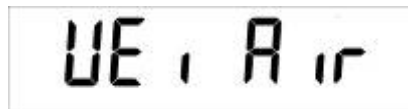

- ⇒ Confirm by pressing the **PRINT** button.
- ⇒ Tare if necessary and hook on the glass sinker centrally.
- ⇒ Wait until the weight display of the weighing balance has become stable and then press the **PRINT** button. „WEI AIR“ appears flashing.
- ⇒ The display for weight determination of the "glass sinker in sample liquid" appears.

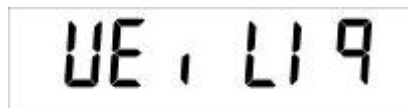

- ⇒ Acknowledge using **PRINT** button
- ⇒ Tare if necessary and immerse the sinker into the measuring fluid
- ⇒ Wait until the weight display of the weighing balance has become stable and then press the **PRINT** button. „WEI LIQ“ appears flashing.
- ⇒ The density of the sample fluid is shown



Return to weighing mode

⇒ Press the **ON/OFF** key

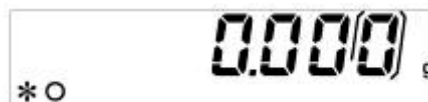

⇒ or use the **MENU** button to start a new measuring cycle.

If at the density determination errors have appeared, „d-----“, is displayed.



11.3 Adding function

This function can be used to automatically add any number of single weighings to a total.

- ⇒ Press repeatedly the **MENU** button in weighing mode until „add“ will be displayed.

A rectangular box containing the word "Add" in a large, black, monospace-style font.

- ⇒ Confirm by pressing the **PRINT** button
The balance will tare automatically and then will change to the zero display

A rectangular box containing the text "0-t" in a large, black, monospace-style font.

A rectangular box containing a downward-pointing arrow above the text "0.0000" g. To the left of the text is a small "* O" symbol.

- ⇒ Deposit weight A.

A rectangular box containing the number "180.688" in a large, black, monospace-style font.

(Example)

- ⇒ Confirm by pressing the **PRINT** button
The displayed value is added into the total adding memory, after that the balance will automatically tare anew and change over to the zero display

A rectangular box containing the text "0-t" in a large, black, monospace-style font.

A rectangular box containing a downward-pointing arrow above the text "0.0000" g. To the left of the text is a small "* O" symbol.

- ⇒ Put on weight B.

A rectangular box containing the number "8.0000" in a large, black, monospace-style font.

(Example)

- ⇒ Confirm by pressing the **PRINT** button

The displayed value is added into the total adding memory, after that the balance will automatically tare anew and change over to the zero display



0-t



*O 0.000g

- ⇒ Proceed in the same manner with the other weights
- ⇒ To print out the total sum of the single weighings, press the **CAL** button

⇒ Press the **MENU** button, the sum of all single weighings will be displayed.



t 188.688

⇒ Press the **MENU** button again, the number of weighings will be displayed



n 2

⇒ Leave the function via the **ON/OFF** button and return to the weighing mode



*O 0.000g

11.4 Checkweighing

An upper and a lower limit value can be established to ensure that the weighed goods are exactly within the established tolerance limits.

The display [L], [ok] or [H] shows whether the goods to be weighed are within the two tolerance limits.

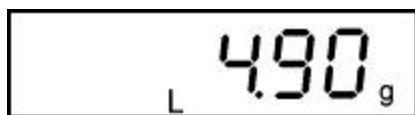

Goods to be weighed below tolerance limit

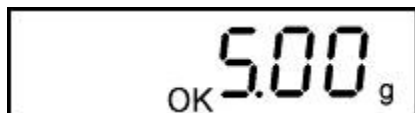

Goods to be weighed within tolerance range

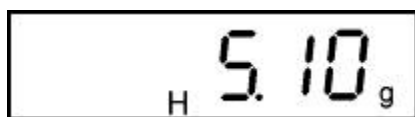

Goods to be weighed above tolerance limit

The indetermination if the goods to be weighed are within the tolerance limits, can additionally be given by an acoustic signal.

⇒ In weighing mode press **MENU** button. The first menu item „count“ is displayed.



⇒ Press **MENU** button repeatedly



⇒ Confirm using the **PRINT** button, the display to enter the lower tolerance limit appears.

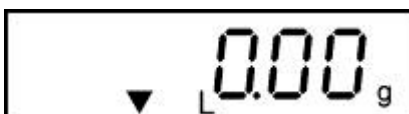

⇒ Enter the lower limit value using the arrow buttons ↓ ↑ ←

⇒ Confirm using the **PRINT** button, the display to enter the upper tolerance limit appears.

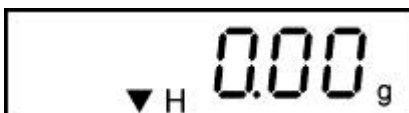

⇒ Enter the upper limit value using the arrow buttons ↓ ↑ ←

⇒ Confirm using the **PRINT** button, the display to adjust the signal tone appears.

⇒ Select the desired settings by pressing the **MENU** button

Beep off Signal tone switched off

Beep on Signal tone on, if weighed goods are within tolerance range

- ⇒ Confirm by pressing the **PRINT** button.
The balance is now in checkweighing mode.
- ⇒ Put on goods to be weighed, tolerance control is started

Return to weighing mode

- ⇒ Press the **ON/OFF** key

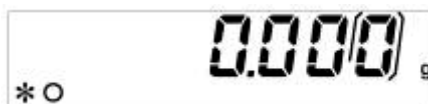

11.5 Percent determination

Percent determination allows weight display in percent, in relation to a reference weight.

11.5.1 Entering the reference weight by weighing

⇒ In weighing mode press **MENU** button. The first menu item „count“ is displayed.

⇒ Press **MENU** button repeatedly

⇒ Acknowledge using **PRINT** button, the current setting is displayed.

⇒ Using **MENU** button select „PERc A“

⇒ If using a weighing container, put this before pressing the **PRINT** button. The taring process is automatically started. „0-t“ is displayed.

⇒ Put on reference weight (=100 %)

⇒ Wait until the weight display of the balance has become stable and then press the **PRINT** button. The weight is adopted as reference (100%).

⇒ Remove reference weight. From now the balance is in percent determining mode.

⇒ Place goods to be weighed on balance.

The weight of the sample is displayed in percentage in terms of the reference weight.

11.5.2 Numeric entering of the reference weight

⇒ In weighing mode press **MENU** button. The first menu item „count“ is displayed.



⇒ Press **MENU** button repeatedly

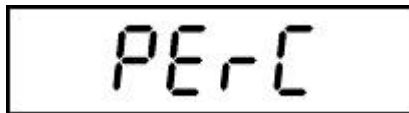

⇒ Acknowledge using **PRINT** button, the current setting is displayed.

⇒ Using **MENU** button select „PERc n“



⇒ Confirm using the **PRINT** button, the display to enter the reference weight appears.

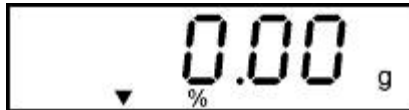

⇒ Press the arrow buttons ↓ ↑ ← to enter the reference weight (100%).

⇒ Confirm input by pressing the **PRINT** button. From now the balance is in percent determining mode.



⇒ Place goods to be weighed on balance.

The weight of the sample is displayed in percentage in terms of the reference weight.

Return to weighing mode

⇒ Press the **ON/OFF** key

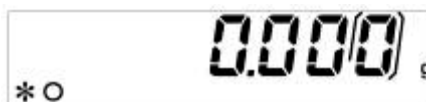

11.6 Animal weighing function

The animal weighing function can be applied for busy weighings. During a defined period the mean value of the weighing results is formed.

The more unquiet the weighed item, the longer the period should be selected.

⇒ In weighing mode press **MENU** button. The first menu item „count“ is displayed.



⇒ Press **MENU** button repeatedly



⇒ Acknowledge using **PRINT** button, the current setting is displayed.

⇒ Press the arrow keys **↓** **↑** to select desired setting.

Scroll forward using **MENU** button

Scroll backward using **CAL** button

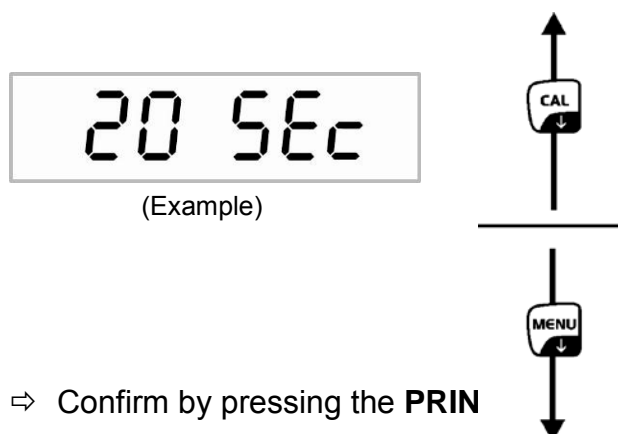

⇒ Confirm by pressing the **PRIN**

⇒ Tare the balance if necessary

⇒ Put the weighing good (animal) on the weighing plate and press the **PRINT** button. In the display runs a „Countdown“.

The average value of the weighing results is displayed and remains displayed on the screen.



⇒ In order to carry out an other measurement, press the **ON/OFF** button **1x**

Return to weighing mode:

⇒ Press the **ON/OFF** key **2x**



11.7 Peak value function

This function displays the highest load value (peak value) of a weighing. The peak value remains in the display until it will be deleted.

⇒ In weighing mode press **MENU** button. The first menu item „count“ is displayed.

A rectangular digital display showing the word "Count" in a large, black, monospace-style font.

⇒ Press **MENU** button repeatedly

A rectangular digital display showing "M LoAd" in a large, black, monospace-style font.

⇒ Confirm using **PRINT** button, the taring process is automatically started. „0-t“ is displayed.

From here the balance is in peak value mode, where a „M“ pops up.

A rectangular digital display showing "M 0.000 g" in a large, black, monospace-style font. A small asterisk and circle icon is visible below the "M".

⇒ Load weighing plate. The maximum load value is displayed.

A rectangular digital display showing "M 68.984 g" in a large, black, monospace-style font. A small asterisk and circle icon is visible below the "M".

⇒ The peak value remains in the display until the **TARE** button is pressed. Then the balance is ready for further measurements.

Return to weighing mode

⇒ Press the **ON/OFF** key

A rectangular digital display showing "0.000 g" in a large, black, monospace-style font. A small asterisk and circle icon is visible below the display.

12 Data output RS 232C

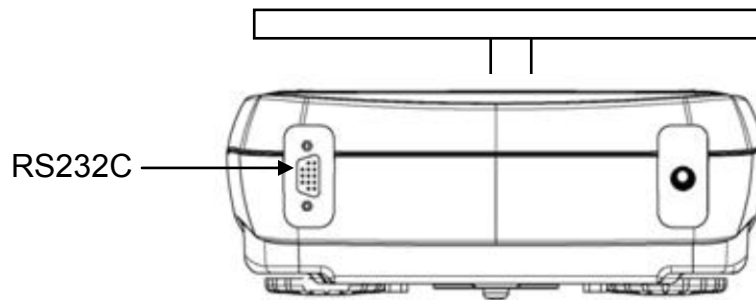

12.1 Technical Data

- 8-bit ASCII Code
- 8 data bits, 1 stop bit, no parity bit
- Baud rate optional from 1200 - 9600 Baud
- For operation with interface faultless operation is only ensured with the correct KERN – interface cable (max. 2m)

12.2 Pin allocation of balance output plug

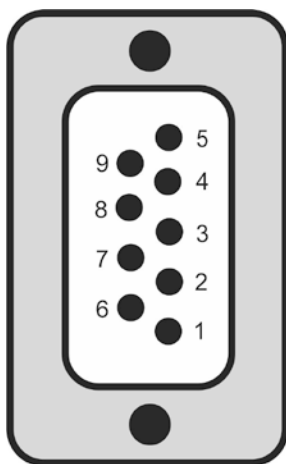

Pin 2	Tx Signal
Pin 3	Rx Signal
Pin 5	GND

12.3 Interface

- Balance – PC 25-pole

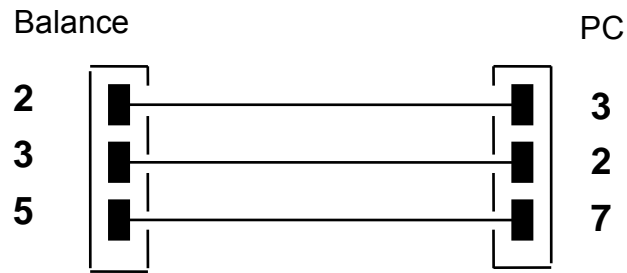

- Balance – PC 9-pole

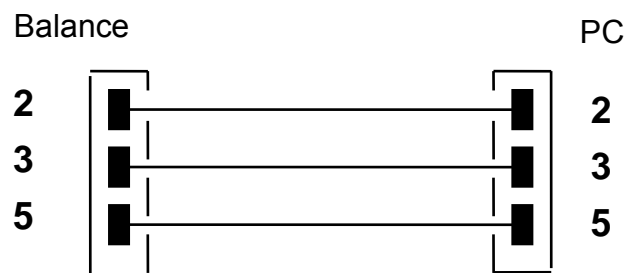

- Balance - printer

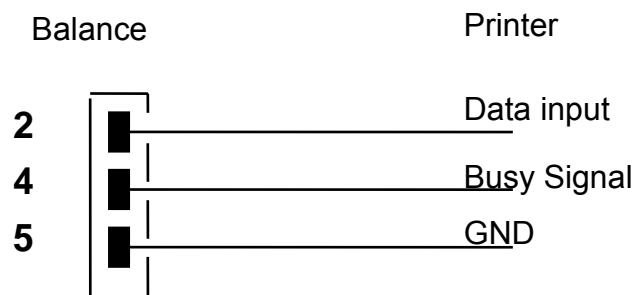

12.4 Data transfer

The data set consists of the following 14 characters:

1. Character	sign -/ blank (weighing value)
2-9. Character	weight or other data
10-12. Character	weighing unit
13. Character	stability display
14. Character	carriage return
15. Character	line feed

12.5 Format for data transmission

At stable weight the format is transferred after pressing the **PRINT** button.

Weighing mode (continuous output and remote control command)

1°	2°	3°	4°	5°	6°	7°	8°	9°	10°	11°	12°	13°	14°	15°r
Character	Weight							Weighing unit			Stability	CR	LF	

Density determination (only remote control command)

1°	2°	3°	4°	5°	6°	7°	8°	9°	10°	11°	12°	13°	14°	15°	16°	17°
d	=	Density				Blank		Weighing unit					CR	LF		

Counting (only remote control command)

Number of pieces

1°	2°	3°	4°	5°	6°	7°	8°	9°	10°	11°	12°	13°	14°	15°	16°
Pcs		:	Blank				Quantity								

Weight of placed pieces

1°	2°	3°	4°	5°	6°	7°	8°	9°	10°	11°	12°	13°	14°	15°	16°	17°	18°	19°	20°
Weight						:	space	Measuring Value						space	g	space	S		

Average parts weight

1°	2°	3°	4°	5°	6°	7°	8°	9°	10°	11°	12°	13°	14°	15°	16°	17°	18°
PMU average piece weight		:	Blank				Measuring Value						space	g			

Percent determination (only remote control command)

Percent value

1°	2°	3°	4°	5°	6°	7°	8°	9°	10°	11°	12°	13°	14°	15°	16°	17°	18°
Percent				.	Blank			Percent							Blank	%	

Weight value

1°	2°	3°	4°	5°	6°	7°	8°	9°	10°	11°	12°	13°	14°	15°	16°	17°	18°
Weight						Blank		Weight value							Blank	g	

Animal weighing (only remote control command)

Time

1°	2°	3°	4°	5°	6°	7°	8°	9°	10°	11°	12°	13°	14°	15°	16°	17°	18°
Time				Blank	=	Blank		Time value		Sec.			Blank				

Average value

1°	2°	3°	4°	5°	6°	7°	8°	9°	10°	11°	12°	13°	14°	15°	16°	17°	18°
Average		.	=	Blank				Average Weight value						Blank		g	

12.6 Remote control instructions

Instruction:	Function
"T" = H54	Taring
"C" = H43	Adjustment
"E" = H45	Edit stable weighing value
"M" = H4D	Menu
"O" = H4F	ON/OFF

12.7 Printer mode

The following conditions must be met to provide successful communication between the weighing balance and the printer.

- Use a suitable cable to connect the weighing balance to the interface of the printer. Faultless operation requires an adequate KERN interface cable.
- The Baud rates of balance and printer must agree, see chap. 9.3.

Printout examples:

Weighing mode/peak value function

.....	22.000 g
-------	----------

Density determination

d= 2.80066 g/cm ³ d

d Measuring value „Density“

Parts counting

Pcs	100
Weight:	300.000 g
PMU:	3.000 g

PCS Number of pieces

Weight Weight of placed pieces

PMU Average parts weight

Percent determination

Perc.	20 %
Weight:	30.000 g

Perc Display value in [%]

Weight Display value in [g]

Animal weighing mode

Time	6 Sec
Ave.:	59.446 g

Add-up mode

1.	14.156 g
2.	18.226 g
<hr/>	
S=	32.382 g



Tolerance weighing

Weight : 0.00g -LOW-

Weight : 49.20g -OK-

Weight : 249.20g -HIGH-

13 Error messages

ERR01	Weight value instable or zeroing not possible. Check the environmental conditions.
ERR02	Adjustment error, e.g. environmental conditions instable
ERR03	Adjustment error e.g. incorrect adjustment weight}
ERR04	Piece weight too small/instable
ERR05	Data transfer not possible, as weighing value is instable. Check the environmental conditions.
ERR06	Weighing value in density determining mode instable. Check the environmental conditions.
ERR07	Incorrect data reading (piece counting, density determination,...)
ERR08	Error at internal adjustment
“UNLOAD”:	Weighing range not achieved. Check position of the weighing plate
“CAL But”	Adjust balance
	Weighing range exceeded, placed load exceeds the capacity of the balance. Unload the balance.
	Weighing range not reached, e.g. weighing plate not in place

14 Service, maintenance, disposal



Before cleaning, please disconnect the appliance from the operating voltage.

14.1 Cleaning

Please do not use aggressive cleaning agents (solvents or similar agents), but a cloth dampened with mild soap suds. Ensure that no liquid penetrates into the device and wipe with a dry soft cloth.

Loose residue sample/powder can be removed carefully with a brush or manual vacuum cleaner.

Spilled weighing goods must be removed immediately.

14.2 Service, maintenance

The appliance may only be opened by trained service technicians who are authorized by KERN.

Before opening, disconnect from power supply.

14.3 Disposal

Disposal of packaging and appliance must be carried out by operator according to valid national or regional law of the location where the appliance is used.

15 Instant help

In case of an error in the program process, briefly turn off the balance and disconnect from power supply. The weighing process must then be restarted from the beginning.

Help:

Fault

Possible cause

The displayed weight does not glow.

- The balance is not switched on.
- The mains supply connection has been interrupted (mains cable not plugged in/faulty).
- Power supply interrupted.
- (Rechargeable) batteries are inserted incorrectly or empty
- No (rechargeable) batteries inserted.

The displayed weight is permanently changing

- Draught/air movement
- Table/floor vibrations
- Weighing plate has contact with other objects.
- Electromagnetic fields / static charging (choose different location/switch off interfering device if possible)

The weighing result is obviously incorrect

- The display of the balance is not at zero
- Adjustment is no longer correct.
- Great fluctuations in temperature.
- Warm-up time was ignored.
- Electromagnetic fields / static charging (choose different location/switch off interfering device if possible)

Should other error messages occur, switch balance off and then on again. If the error message remains inform manufacturer.