



MicroOhm 2A
MI 3242
Instruction manual
Version 1.0, Code no 20 752 011

Distributor:

Manufacturer:

METREL d.d.
Ljubljanska cesta 77
1354 Horjul
Slovenia
web site: <http://www.metrel.si>
e-mail: metrel@metrel.si



Mark on your equipment certifies that this equipment meets the requirements of the EU (European Union) concerning safety and electromagnetic compatibility regulations

© 2012 METREL

No part of this publication may be reproduced or utilized in any form or by any means without permission in writing from METREL.

Table of contents

1	General description	5
1.1	Features	5
2	Safety and operational considerations	6
2.1	Warnings and notes	6
2.2	Battery and charging	8
2.2.1	<i>New battery cells or cells unused for a longer period</i>	9
2.3	Standards applied	10
3	Instrument description	11
3.1	Front panel	11
3.2	Connector panel	12
3.3	Back side.....	13
3.4	Accessories	14
3.5	Display organization	15
3.5.1	<i>Battery and time indication</i>	15
3.5.2	<i>Message field</i>	15
3.5.3	<i>Help screens</i>	16
3.5.4	<i>Backlight and contrast adjustments</i>	17
4	Instrument operation	18
4.1	Function selection	18
5	Settings menu	19
5.1	Selection language.....	19
5.2	Initial settings.....	20
5.3	Limits settings.....	20
5.4	Memory	21
5.5	Setting date and time	21
5.6	Instrument info.....	22
6	Measurements	23
6.1	Four wire Kelvin method.....	23
6.2	Resistance measurement.....	24
6.2.1	<i>Single Mode</i>	25
6.2.2	<i>Continuous Mode</i>	26
6.2.3	<i>Auto Mode</i>	27
6.2.4	<i>Inductive Mode</i>	28
6.3	Voltage TRMS	29
7	Data handling	30
7.1	Memory organization	30
7.2	Data structure.....	30
7.3	Storing test results.....	31
7.4	Recalling test results	32
7.5	Clearing stored data	33
7.5.1	<i>Clearing complete memory content</i>	33
7.5.2	<i>Clearing measurement(s) in selected location</i>	34

7.5.3	Clearing individual measurements	34
9	Maintenance	37
9.1	Cleaning	37
9.2	Periodic calibration	37
9.3	Service	37
10	Technical specifications.....	38
10.1	Resistance measurement.....	38
10.2	Measurement parameters	39
10.3	Voltage and frequency.....	39
10.3.1	Voltage.....	39
10.3.2	Frequency.....	39
10.4	General data.....	40

1 General description

1.1 Features

MI 3242 MicroOhm 2A is a portable, lightweight (< 1.5 kg) **bidirectional** low resistance ohmmeter using **four wire Kelvin method** to measure low resistances of:

- Switches
- Relays
- Connectors
- Bus bars
- Power distribution cable joints
- Motor & generator winding
- Power transformers
- Power inductors
- Rail track joints
- Wire and cable resistance
- Welding joints

The instrument is designed and produced with the extensive knowledge and experience acquired through many years of working in this sector.

Available functions offered by the **MicroOhm 2A** meter:

- Resistance measurement (Four wire Kelvin method);
- High Resolution **24-Bit Σ - Δ ADC**
- Wide measuring range (1 $\mu\Omega$... 199.9 Ω);
- Adjustable test current (10 mA ... 2 A);
- Hi/Lo limits;
- Automatic thermal **EMF elimination**;
- Noise rejection (50/60 Hz);
- Four different measuring modes (single, continuous, inductive, automatic);
- USB and RS232 communication;
- TRMS voltage meter;

High over-voltage category **CAT III 600V**.

A 128x64 dot matrix LCD offers easy-to-read results and all associated parameters.

The operation is straightforward and clear to enable the user to operate the instrument without the need for special training (except reading and understanding this Instruction Manual).

Test results can be stored on the instrument. **PC software HVLink PRO** that is supplied as a part of standard set enables transfer of measured results to PC where can be analysed or printed.

2 Safety and operational considerations

2.1 Warnings and notes

In order to maintain the highest level of operator safety while carrying out various tests and measurements Metrel recommends keeping your MicroOhm 2A instruments in good condition and undamaged. When using the instrument, consider the following general warnings:

- ❑ The  symbol on the instrument means »Read the Instruction manual with special care for safe operation«. The symbol requires an action!
- ❑ If the test equipment is used in a manner not specified in this user manual, the protection provided by the equipment could be impaired!
- ❑ Read this user manual carefully, otherwise the use of the instrument may be dangerous for the operator, the instrument or for the equipment under test!
- ❑ Do not use the instrument or any of the accessories if any damage is noticed!
- ❑ Consider all generally known precautions in order to avoid risk of electric shock while dealing with hazardous voltages!
- ❑ Do not use the instrument in supply systems with voltages higher than 600 V!
- ❑ Service intervention or adjustment is only allowed to be carried out by competent authorized personnel!
- ❑ Use only standard or optional test accessories supplied by your distributor!
- ❑ The instrument comes supplied with rechargeable Ni-MH battery cells. The cells should only be replaced with the same type as defined on the battery compartment label or as described in this manual. Do not use standard alkaline battery cells while the power supply adapter is connected, otherwise they may explode!
- ❑ Hazardous voltages exist inside the instrument. Disconnect all test leads and switch off the instrument before opening the battery compartment.

⚠ Warnings related to measurement functions:**Resistance, voltage and frequency measurements**

- ❑ Resistance measurement should only be performed on de-energized objects!
- ❑ Do not touch the test object during the measurement or before it is fully discharged! Risk of electric shock!
- ❑ When a resistance measurement has been performed on an inductive object, automatic discharge may not be done immediately!
- ❑ Do not connect test terminals to external voltage higher than 600 V (AC or DC) in order not to damage the test instrument!

Notes related to measurement functions:**General**

- ❑ Warning  will appear on screen and the resistance test will not be performed if voltages higher than 8 V (AC or DC) are detected between test terminals. There will be no warning if all terminals are at the same potential.
- ❑ PASS / FAIL indication is enabled when limit is set. Apply appropriate limit value for evaluation of measurement results.

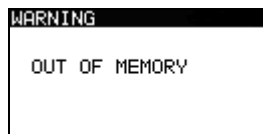

The internal memory is full!

2.2 Battery and charging

The instrument uses six AA size alkaline or rechargeable Ni-MH battery cells. Nominal operating time is declared for cells with nominal capacity of 2100 mAh.

Battery condition is always displayed in the lower right display part.

In case the battery is too weak the instrument indicates this as shown in figure 2.1. This indication appears for a few seconds and then the instrument turns itself off.

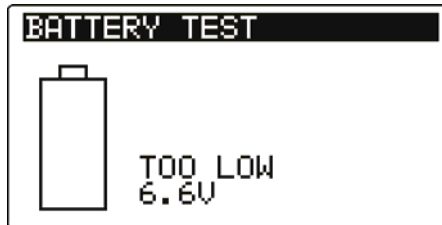

Figure 2.1: Discharged battery indication

The battery is charged whenever the power supply adapter is connected to the instrument. The power supply socket polarity is shown in figure 2.2. Internal circuit controls charging and assures maximum battery lifetime.



Figure 2.2: Power supply socket polarity

The instrument automatically recognizes the connected power supply adapter and begins charging.

Symbols:

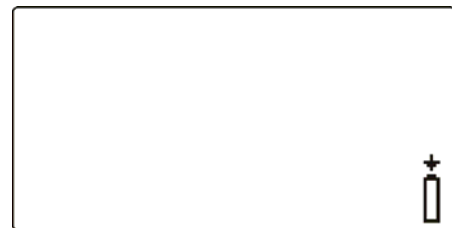
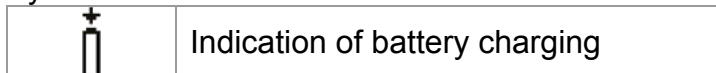

Figure 2.3: Charging indication

- ❑ When connected to an installation, the instruments battery compartment can contain hazardous voltage inside! When replacing battery cells or before opening the battery compartment cover, disconnect any measuring accessory connected to the instrument and turn off the instrument,
- ❑ Ensure that the battery cells are inserted correctly otherwise the instrument will not operate and the batteries could be discharged.
- ❑ If the instrument is not to be used for a long period of time, remove all batteries from the battery compartment.
- ❑ Alkaline or rechargeable Ni-MH batteries (size AA) can be used. Metrel recommends only using rechargeable batteries with a capacity of 2100mAh or above.
- ❑ Do not recharge alkaline battery cells!

- Use only power supply adapter delivered from the manufacturer or distributor of the test equipment to avoid possible fire or electric shock!

2.2.1 New battery cells or cells unused for a longer period

Unpredictable chemical processes can occur during the charging of new battery cells or cells that have been left unused for a longer period (more than 3 months). Ni-MH and Ni-Cd cells can be subjected to these chemical effects (sometimes called the memory effect). As a result the instrument operation time can be significantly reduced during the initial charging/discharging cycles of the batteries.

In this situation, Metrel recommend the following procedure to improve the battery lifetime:

Procedure	Notes
➤ Completely charge the battery.	At least 14h with in-built charger.
➤ Completely discharge the battery.	This can be performed by using the instrument normally until the instrument is fully discharged.
➤ Repeat the charge / discharge cycle at least 2-4 times.	Four cycles are recommended in order to restore the batteries to their normal capacity.

Notes:

- The charger in the instrument is a pack cell charger. This means that the battery cells are connected in series during the charging. The battery cells have to be equivalent (same charge condition, same type and age).
- One different battery cell can cause an improper charging and incorrect discharging during normal usage of the entire battery pack (it results in heating of the battery pack, significantly decreased operation time, reversed polarity of defective cell,...).
- If no improvement is achieved after several charge / discharge cycles, then each battery cell should be checked (by comparing battery voltages, testing them in a cell charger, etc). It is very likely that only some of the battery cells are deteriorated.
- The effects described above should not be confused with the normal decrease of battery capacity over time. Battery also loses some capacity when it is repeatedly charged / discharged. Actual decreasing of capacity, versus number of charging cycles, depends on battery type. This information is provided in the technical specification from battery manufacturer.

2.3 Standards applied

The MicroOhm 2A instruments are manufactured and tested in accordance with the following regulations:

Electromagnetic compatibility (EMC)

EN 61326 Electrical equipment for measurement, control and laboratory use – EMC requirements
Class A

Safety (LVD)

EN 61010-1 Safety requirements for electrical equipment for measurement, control and laboratory use – Part 1: General requirements

EN 61010-2-030 Safety requirements for electrical equipment for measurement, control and laboratory use – Part 2-030: Particular requirements for testing and measuring circuits

EN 61010-031 Safety requirements for electrical equipment for measurement, control and laboratory use – Part 031: Safety requirements for hand-held probe assemblies for electrical measurement and test

Note about EN and IEC standards:

- Text of this manual contains references to European standards. All standards of EN 6XXXX (e.g. EN 61010) series are equivalent to IEC standards with the same number (e.g. IEC 61010) and differ only in amended parts required by European harmonization procedure.

3 Instrument description

3.1 Front panel

The operator's panel is shown in Figure 3.1 below.

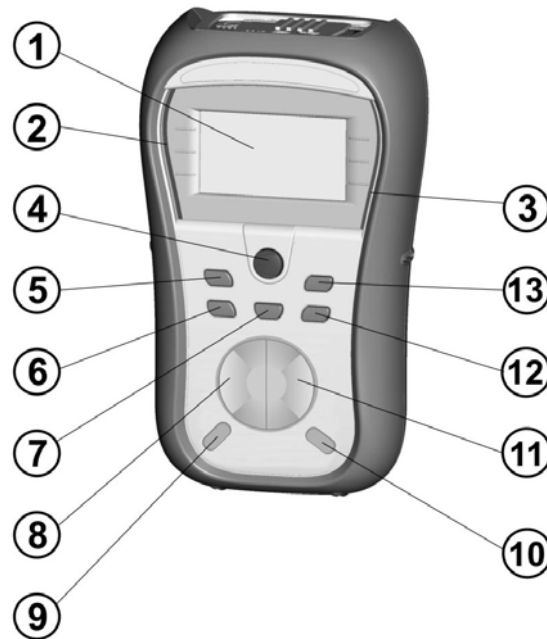

Figure 3.1: Front panel

Legend:

1	LCD	128 x 64 dots matrix display with backlight.
4	TEST	Starts testing / confirms selected option
5	UP	Modifies selected parameter.
6	DOWN	
7	MEM	Store / recall tests in memory of instrument.
8	Function selector	Selects test function.
11		
9	Backlight, Contrast	Changes backlight level and contrast.
10	ON / OFF	Switches the instrument power on or off. The instrument automatically turns off 15 minutes after the last key was pressed.
12	HELP	Accesses help menus.
13	TAB	Selects the parameters in selected function.
2	FAIL	Indicates PASS/ FAIL of result.
3	PASS	

3.2 Connector panel

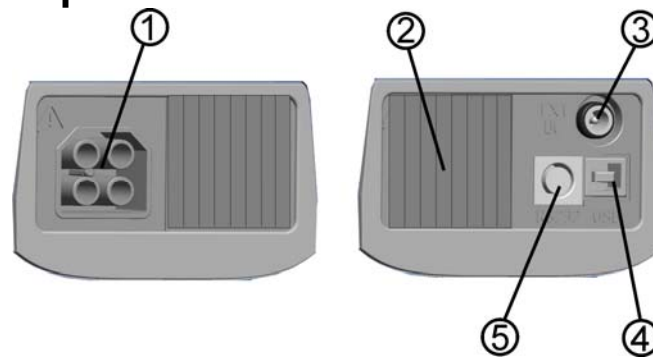

Figure 3.2: Connector panel

Legend:

1	Test connector	Measuring inputs / outputs
2	Protection cover	
3	Charger socket	For connection of external charger
4	USB connector	Communication with PC USB (1.1) port
5	PS/2 connector	Communication with printer Communication with PC RS-232 port

Warnings!

- ❑ **Maximum allowed voltage between any test terminal and ground is 600 V!**
- ❑ **Maximum allowed voltage between test terminals is 600 V!**
- ❑ **Maximum short-term voltage of external power supply adapter is 14 V!**
- ❑ **Use original test accessories only!**

3.3 Back side



Figure 3.3: Back side

Legend:

- | | |
|---|--|
| 1 | Inserts for side belt |
| 2 | Battery compartment cover |
| 3 | Fixing screw for battery compartment cover |
| 4 | Back side information label |
| 5 | Holder for inclined position of the instrument |

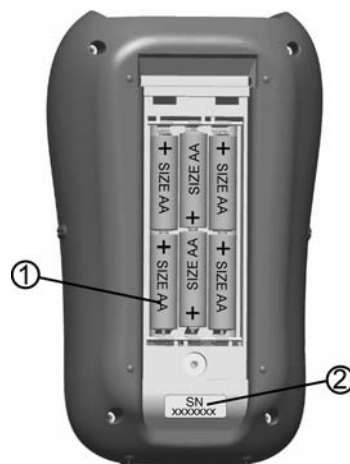

Figure 3.4: Battery compartment

Legend:

- | | | |
|---|---------------------|--|
| 1 | Battery cells | Size AA, alkaline or rechargeable NiMH |
| 2 | Serial number label | |

3.4 Accessories

The accessories consist of standard and optional accessories. Optional accessories can be delivered upon request. See *attached* list for standard configuration and options or contact your distributor or see the METREL home page: <http://www.metrel.si>.



Figure 3.5: Standard set of the instrument

- › Instrument MI 3242 MicroOhm 2A
- › Test lead, 2,5 m, 1 pcs (black, red)
- › Crocodile clip, 4 pcs (black, red)
- › Test probe, 2 pcs (black)
- › Small soft carrying bag
- › Set of NiMH battery cells 6pcs
- › Power supply adapter
- › RS232 – PS2 serial cable
- › USB cable
- › PC SW HVLink PRO
- › Instruction manual (on CD)
- › Calibration certificate

3.5 Display organization

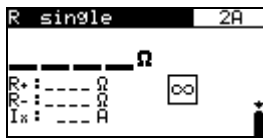

Figure 3.6: Typical function display

	Function name
	Result field
	Test parameter field
	Message field
	Battery and time indication

3.5.1 Battery and time indication

The indication indicates the charge condition of battery and connection of external charger.



Battery capacity indication.



Low battery.

Battery is too weak to guarantee correct result. Replace or recharge the battery cells.



Recharging in progress (if power supply adapter is connected).



Time indication (hh:mm).

Warning:

- If the batteries are removed for more than 1 minute, set time and date will be lost and Initial settings will be restored.

Note:

- Date and time is attached to each stored result.

3.5.2 Message field

In the message field warnings and messages are displayed.



Test result can be saved.



High voltage is present on terminals.

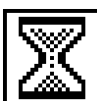

Measurement in progress.

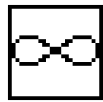

P1, P2, C1 or C2 terminal is not connected to the instrument or too high resistance is detected.

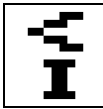

Low test current (test current is out of defined limits $I_{set} - 10\%$).



Measurement result is within defined limits.



Measurement result is out of defined limits.



Measurement result is out of defined high limit.



Measurement result is out of defined low limit.

3.5.3 Help screens

HELP	Opens help screen.
-------------	--------------------

Help menus are available in all functions. The Help menu contains schematic diagrams for illustrating how to properly connect the instrument to the test object. Press the **HELP** key in order to view the associated Help menu.

Keys in help menu:

UP / DOWN	Selects next / previous help screen.
Function selector / HELP	Exits help menu.

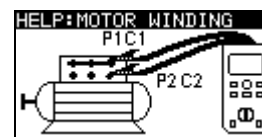
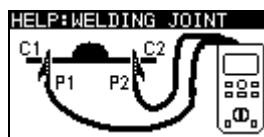

Figure 3.7: Examples of help screens

3.5.4 Backlight and contrast adjustments

With the **BACKLIGHT** (☀) key backlight and contrast can be adjusted.

Click	Toggles backlight intensity level.
Keep pressed for 1 s	Locks high intensity backlight level until power is turned off or the key is pressed again.
Keep pressed for 2 s	Bargraph for LCD contrast adjustment is displayed.

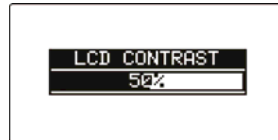

Figure 3.8: Contrast adjustment menu

Keys for contrast adjustment:

DOWN	Reduces contrast.
UP	Increases contrast.
TEST	Accepts new contrast.
BACKLIGHT (☀)	Exits without changes.

4 Instrument operation

4.1 Function selection

For selecting test function the **FUNCTION SELECTOR** shall be used.

Keys:

FUNCTION SELECTOR	Select test / measurement function: < RESISTANCE > Resistance measurement. < VOLTAGE TRMS > Voltage and frequency measurement. < SETTINGS > General instrument settings.
UP/DOWN	Selects sub-function in selected measurement function.
TAB	Selects the test parameter to be set or modified.
TEST	Runs selected test / measurement function.

Keys in **test parameter** field:

UP/DOWN	Changes the selected parameter.
TAB	Selects the next measuring parameter.
FUNCTION SELECTOR	Exits test parameter field selection.

5 Settings menu

In the Settings menu different parameters of the instrument can be viewed or set.



Figure 5.1: Settings menu

Keys:

UP/DOWN	Select the setting to adjust or view: <SELECT LANGUAGE> instrument language; <INITIAL SETTINGS> factory settings. <LIMITS SETTINGS> limit values selection; <MEMORY> to recall or clear stored results; <SET DATE/TIME> date and time; <INSTRUMENT INFO> basic instrument information.
TEST	Confirms selection.
FUNCTION SELECTOR	Returns to the <i>Main menu</i> .

5.1 Selection language

The instrument language can be set in this menu.

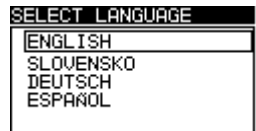

Figure 5.2: Language menu

Keys:

UP/DOWN	Selects the language.
TEST	Confirms selection and returns to <i>Settings menu</i> .
FUNCTION SELECTOR	Returns to <i>Main menu</i> without changes.

5.2 Initial settings

In this menu the following instrument parameters can be set to their initial values:

- all measurement parameters;
- LCD settings;
- language;

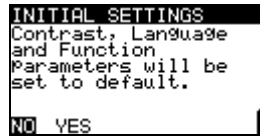

Figure 5.3: Initial settings menu

Keys:

TAB	Selects YES or NO
TEST	Confirms selection. The instrument will restart with the default settings (if YES is selected). Returns to the Settings menu without changes (if NO is selected).
FUNCTION SELECTOR	Returns to Main menu without changes.

5.3 Limits settings

With High and Low limit the user is allowed to set limit resistance values. Measured resistance is compared against those limits. Result is validated only if it is within the given limits.



Figure 5.4: Limits settings menu

Parameters for Limits settings:

Limit Hi	Resistance limit value [OFF, 1.00 $\mu\Omega$ - 10.00 $\mu\Omega$, 20.0 $\mu\Omega$ - 100.0 $\mu\Omega$, 0.200 m Ω - 1.000 m Ω , 2.00 m Ω - 10.00 m Ω , 20.0 m Ω - 100.0 m Ω , 0.200 Ω - 1.000 Ω , 2.00 Ω - 10.00 Ω , 20.0 Ω - 200.0 Ω]
Limit Lo	

Keys:

UP/DOWN	Selects the High or Low limit to be modified.
TEST	Enters Limits modification screen.
FUNCTION SELECTOR	Returns to Main menu without changes.



Figure 5.5: Limits modifications

Keys in Limits modifications screen:

UP/DOWN	Modifies selected limit.
MEM	Save selection and returns to Limits Settings menu .
FUNCTION SELECTOR	Returns to Main menu without changes.

Note:

- Limits won't be saved if Hi limit value is lower than Lo limit value. "Not valid limits" message will appear on screen during saving limits process.

5.4 Memory

Stored results can be recalled or deleted in this menu.

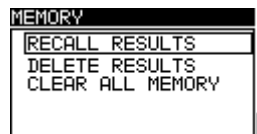

Figure 5.6: Memory menu

Keys:

UP/DOWN	Selects option.
TEST	Enters selected option.
FUNCTION SELECTOR	Returns to Main menu without changes.

See chapter 7 *Data handling* for more information.

5.5 Setting date and time

Date and time can be set in this menu.

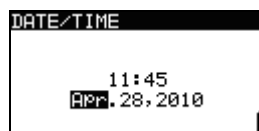

Figure 5.7: Date and time menu

Keys:

TAB	Selects the field to be changed.
UP/DOWN	Modifies selected field.
TEST	Confirms selection and returns to Settings menu .
FUNCTION SELECTOR	Returns to Main menu without changes.

Warning:

- If the batteries are removed for more than 1 minute the set time and date will be lost.

5.6 Instrument info

In this menu the following instrument data is shown:

- instrument type;
- model number;
- firmware and hardware version;
- serial number;
- calibration date.

```
INSTRUMENT INFO
MicroOhm 2A
MI 3242
Version: 2.1.03-E
S/N: 1111161
http://www.metrel.si
Cal.: 04.01.2079
```

Figure 5.8: Instrument info menu

Keys:

FUNCTION SELECTOR / TEST	Returns to Main menu .
---	-------------------------------

6 Measurements

6.1 Four wire Kelvin method

When measuring resistance $<20 \Omega$ it is advisable to use a four wire measurement technique (Figure 6.1), for achieving high accuracy. By using this type of measurement configuration the test lead resistance is not included in the measurement, and the need for lead calibrating and balancing is eliminated.

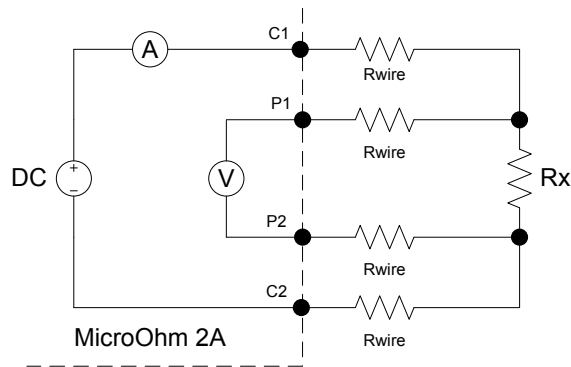

Figure 6.1: Four wire Kelvin method

The measuring current is passed through the unknown resistance R_x using the C1 and C2 leads. The placing of these leads is not critical but should always be outside the P1 and P2 leads. The Voltage drop across the R_x is measured across P1 and P2 and these should be placed exactly at the points to be measured.

Note about poor connection:

- Most measurement errors are caused by poor or inconsistent connection of the object under test. It is essential to ensure that the device under test has clean, oxide and dirt free contacts. High resistance connection will cause errors and may prevent the selected current to flow, because of the high resistance of C1 - C2 loop.

Note:

- **Ohm's law** states that the current through a conductor between two points is directly proportional to the potential difference or voltage across the two points, and inversely proportional to the resistance between them. The mathematical equation that describes this relationship is:

$$I[\text{Amper}] = \frac{U[\text{Volt}]}{R[\text{ohm}]} \Rightarrow R_x[\text{ohm}] = \frac{U[\text{Volt}]}{I[\text{Amper}]}$$

6.2 Resistance measurement

Test can be started from the Resistance window. Before carrying out a test the parameters (Mode and Current) can be edited.

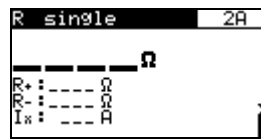

Figure 6.2: Resistance menu

Test parameters for Resistance measurement

Mode	Sub-function [Single, Continuous, Auto, Inductive]
Current	Test current [2 A, 100 mA, 10 mA]

Keys:

TAB	Selects the field to be changed.
▲ / ▼	Modifies selected field.
TEST	Start the resistance measurement.

Test circuits for Resistance measurement

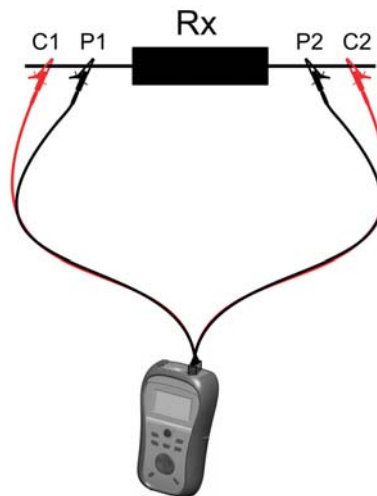

Figure 6.3 Resistance measurement connection

Resistance measurement procedure:

- Select the RESISTANCE function.
- Set the test parameters (mode and test current).
- Set limits (optional). (See chapter 5.3 *Limits settings*.)
- Connect device under test to the instrument (see figure 6.3).
- Press the TEST key to start the measurement.
- Press the TEST key to stop the measurement (not used in single mode).
- Store the result by pressing MEM key (optional).



Figure 6.4: Examples of Resistance measurement results

Note:

- Consider displayed warnings when starting the measurement!

6.2.1 Single Mode

Single mode makes a single bidirectional measurement. The instrument will measure resistance in both directions (thermal EMF elimination). The main result displayed on the display is an average ($R = \frac{R_+ + R_-}{2}$).

Single measurement I/t plot

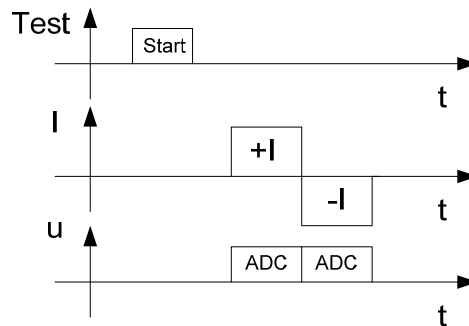

Figure 6.5: Single Mode

Note:

- The Single Mode can be primarily used for measuring:
 - Relays
 - Switches
 - Connectors
 - Bus bars
 - Power distribution cable joints
 - Welding joints

6.2.2 Continuous Mode

Continuous mode makes continuous bidirectional measurements. The instrument will measure resistance in both directions (thermal EMF elimination) and repeating the measurements until the TEST key will be pressed. The main result displayed on the display is an average of the last bidirectional measurement ($R = \frac{R_+ + R_-}{2}$).

The measurement is started and stopped by the user.

Continuous measurement I/t plot

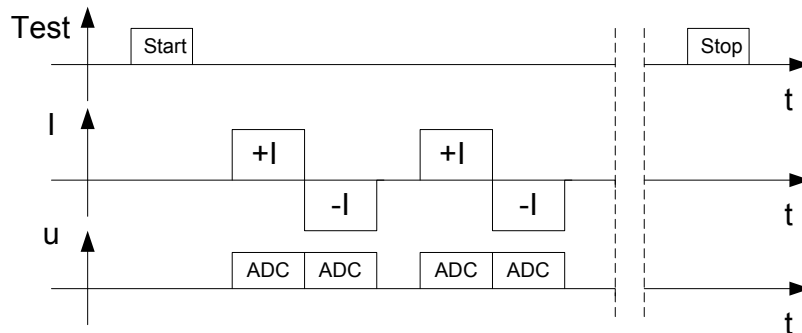

Figure 6.6: Continuous Mode

Note:

- The Continuous Mode is especially helpful for troubleshooting.

6.2.3 Auto Mode

Automatic mode makes a single bidirectional measurement. The instrument will measure resistance in both directions (thermal EMF elimination) and started a single measurement every time the P1, P2, C1 and C2 are connected to the test object. The main result displayed on the display is an average of the last bidirectional measurement

$$(R = \frac{R_+ + R_-}{2}).$$

To make another measurement simply break and remake contact with the test sample.

Automatic measurement I/t plot

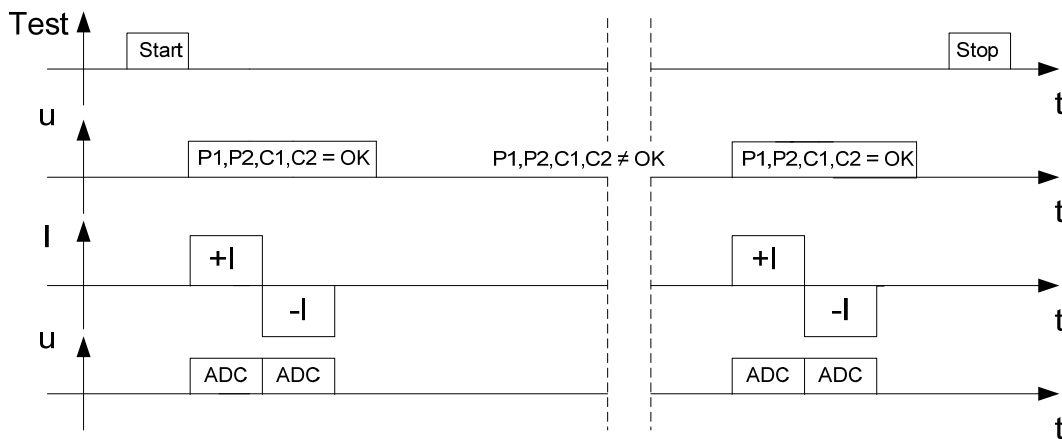

Figure 6.7: Automatic Mode

Note:

- The Automatic Mode can be primarily used for measuring Bus bars.

Note about thermal EMF:

A junction between two different metals produces a voltage related to a temperature difference (thermocouple). MicroOhm 2A eliminates the thermal EMF effect by measuring resistance in both directions I+ and I-.

6.2.4 Inductive Mode

Inductive mode makes a single unidirectional measurement. It is intended for measuring resistance on inductive objects. Depending on the size of the inductive object, testing times could be very short for small objects or very long for the larger, high inductive objects.

Before the desired current (for testing purpose) can flow, this energy requirement must be met ($W = 1/2 \times L \times I^2$).

Inductive measurement I/t plot

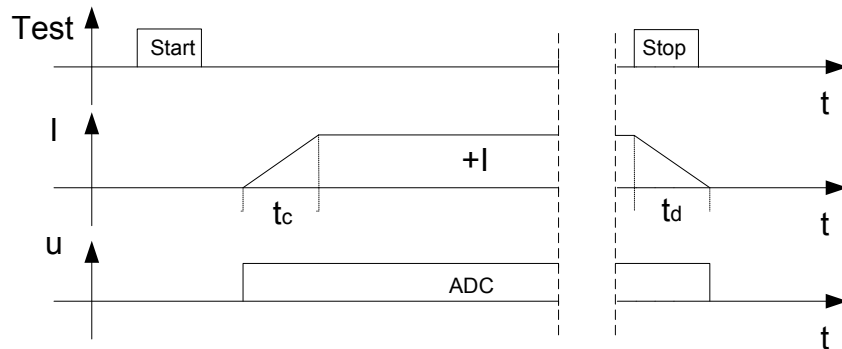

Figure 6.8: Inductive Mode

t_c charging time (depends on the size of the inductor).
t_d discharging time.

Note:

- The Inductive Mode can be primarily used for measuring:
 - Motor & generator winding
 - Power transformers
 - Power inductors
 - Wire and cable resistance

Warnings:

- Do not touch the test object during the measurement or before it is fully discharged! Risk of electric shock!
- When a resistance measurement has been performed on an inductive object, automatic discharge may not be done immediately!
- High voltage can appear on test terminals when measuring inductive object!

6.3 Voltage TRMS

It is a simple function that continuously measures the voltage and frequency across C1, P1 – C2, P2 connector. Measured voltage and frequency in function VOLTAGE TRMS can be stored.

Test circuit for voltage measurement

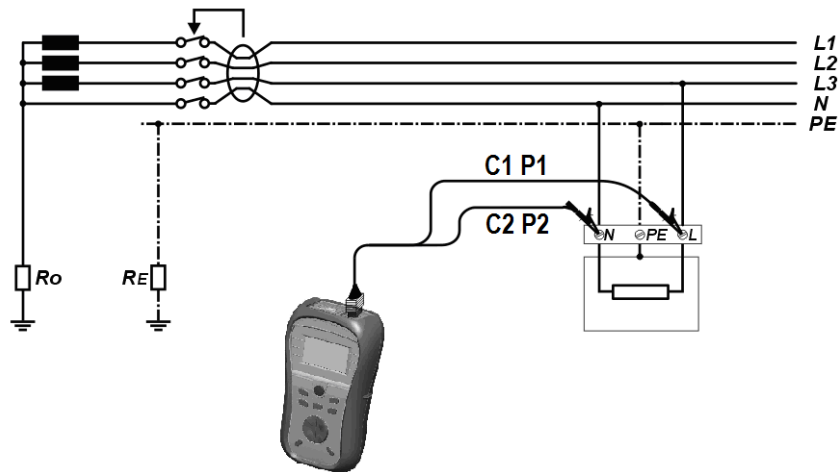

Figure 6.9: Voltage TRMS connection

Voltage TRMS procedure

- Select the VOLTAGE TRMS function.
- Insert the test lead connector in to the instrument.
- Connect test probes or crocodile clips on C1, P1 and C2, P2 and connect it to the measuring points (see figure 6.9).
- Store the result by pressing MEM key (optional).

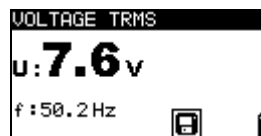

Figure 6.10: Voltage TRMS test result

7 Data handling

7.1 Memory organization

Measurement results together with all relevant parameters can be stored in the instrument's memory. After the measurement is completed, results can be stored to the flash memory of the instrument, together with the sub-results and function parameters.

7.2 Data structure

The instrument's memory place is divided into 3 levels each containing 199 locations. The number of measurements that can be stored into one location is not limited.

RECALL RESULTS
OBJECT 001 LOC1 002 LOC2 004
> No.: 1/4 VOLTAGE

Figure 7.1: Data structure and measurement fields

Data structure field

RECALL RESULTS	Memory operation menu
OBJECT 001 LOC1 002 LOC2 004	Data structure field
OBJECT 001	<input type="checkbox"/> 1st level: OBJECT: Default location name (object and its successive number).
LOC1 002	<input type="checkbox"/> 2nd level: Number of Results:
LOC2 004	<input type="checkbox"/> 3rd level: Number of Results:

Measurement field

No.: 1/4	No. of selected test result / No. of all stored test results in selected location.
VOLTAGE	Type of stored measurement in the selected location.

7.3 Storing test results

After the completion of a test the results and parameters are ready for storing (📁 icon is displayed in the information field). By pressing the **MEM** key, the user can store the results.

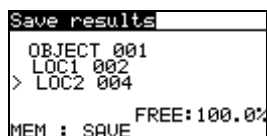

Figure 7.2: Save test menu

FREE:100.0%

Memory available for storing results.

Keys in save test menu - data structure field:

TAB	Selects the location element (Object / Loc1 / Loc2).
UP / DOWN	Selects number of selected location element (1 to 199).
MEM	Saves test results to the selected location and returns to the measuring menu.
FUNCTION SELECTOR	Exits back to Main menu without saving.

Notes:

- The instrument offers to store the result to the last selected location by default.
- If the measurement is to be stored to the same location as the previous one just press the **MEM** key twice.

7.4 Recalling test results

Press the **MEM** key in a main function menu when there is no result available for storing or select **MEMORY** in the **SETTINGS** menu.

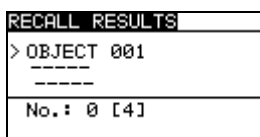

Figure 7.3: Recall menu - structure field selected

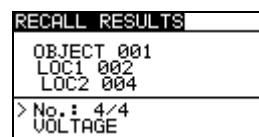

Figure 7.4: Recall menu - measurements field selected

Keys in recall memory menu (structure field selected):

TAB	Selects the location element (Object / Loc1 / Loc2).
UP / DOWN	Selects number of selected location element (1 to 199).
MEM	Enters measurements field.
TEST / FUNCTION SELECTOR	Exits back to <i>Main menu</i> .

Keys in recall memory menu (measurements field selected):

UP / DOWN	Selects the stored measurement.
TAB	Returns to structure field.
MEM	View selected measurement results.
TEST / FUNCTION SELECTOR	Exits back to <i>Main menu</i> .

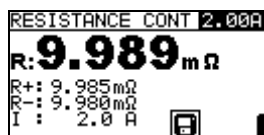

Figure 7.5: Example of recalled measurement result

Keys in recall memory menu (measurement results are displayed):

UP / DOWN	Displays measurement results stored in selected location.
MEM	Returns to measurements field.
TEST / FUNCTION SELECTOR	Exits back to <i>Main menu</i> .

7.5 Clearing stored data

7.5.1 Clearing complete memory content

Select **CLEAR ALL MEMORY** in **MEMORY** menu. A warning will be displayed.

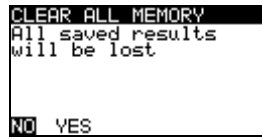

Figure 7.6: Clear all memory

Keys in clear all memory menu:

TAB	Selects YES or NO.
TEST	Confirms clearing memory (if YES is selected). Exits back without changes (if NO is selected).
FUNCTION SELECTOR	Exits back to <i>Main menu</i> without changes.

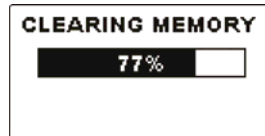

Figure 7.7: Clearing memory in progress

7.5.2 Clearing measurement(s) in selected location

Select **DELETE RESULTS** in **MEMORY** menu.

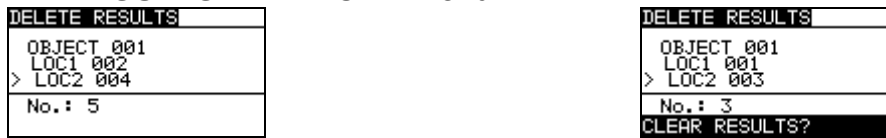

Figure 7.8: Clear measurements menu (structure field selected)

Keys in delete results menu (structure field selected):

TAB	Selects the location element (Object / Loc1 / Loc2).
UP / DOWN	Selects number of selected location element (1 to 199).
TEST	Enters dialog box for deleting all measurements in selected location and its sub-locations.
FUNCTION SELECTOR	Exits back to <i>Main menu</i> without changes.
MEM	Enters measurements field for deleting individual measurements.

Keys in dialog for confirmation to clear results in selected location:

TEST	Deletes all results in selected location.
UP / DOWN TAB / MEM	Returns to structure field without changes.
FUNCTION SELECTOR	Exits back to <i>Main menu</i> without changes.

7.5.3 Clearing individual measurements

Select **DELETE RESULTS** in **MEMORY** menu.

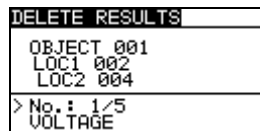

Figure 7.9: Menu for clearing individual measurement (measurement field selected)

Keys in delete results menu (structure field selected):

TAB	Selects the location element (Object / Loc1 / Loc2).
UP / DOWN	Selects number of selected location element (1 to 199).
MEM	Enters measurements field.
TEST / FUNCTION SELECTOR	Exits back to <i>Main menu</i> .

Keys in delete results menu (measurements field selected):

UP / DOWN	Selects measurement.
TEST	Opens dialog box for confirmation to clear selected measurement.
TAB	Returns to structure field.
FUNCTION SELECTOR	Exits back to Main menu without changes.

Keys in dialog for confirmation to clear selected result(s):

TEST	Deletes selected measurement result.
UP / DOWN TAB / MEM	Exits back to measurements field without changes.
FUNCTION SELECTOR	Exits back to Main menu without changes.

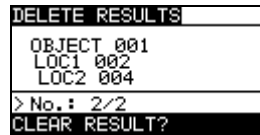

Figure 7.10: Dialog for confirmation

8 Communication

The instrument can communicate with the HVLink PRO PC software. The following action is supported:

- Saved results can be downloaded and stored to a PC.

A special communication program on the PC automatically identifies the instrument and enables data transfer between the instrument and the PC.

There are two communication interfaces available on the instrument: USB or RS 232.

The instrument automatically selects the communication mode according to the detected interface. USB interface has priority.

How to transfer stored data:

- RS 232 communication: connect a PC COM port to the instrument PS/2 connector using the PS/2 - RS232 serial communication cable.
- USB communication: connect a PC USB port to the instrument USB connector using the USB interface cable.
- Switch on the PC and the instrument.
- Run the HVLink PRO program.
- The PC and the instrument will automatically recognize each other.
- The instrument is prepared to download data to the PC.

Note:

- USB drivers should be installed on PC before using the USB interface. Refer to USB installation instructions available on installation CD.

9 Maintenance

Unauthorized persons are not allowed to open the MicroOhm 2A instrument. There are no user replaceable components inside the instrument, except the battery.

Warning:

- ❑  **Disconnect all measuring accessory and switch off the instrument before opening battery cover!**

9.1 Cleaning

No special maintenance is required for the housing. To clean the surface of the instrument use a soft cloth slightly moistened with soapy water or alcohol. Then leave the instrument to dry totally before use.

Warnings:

- ❑ Do not use liquids based on petrol or hydrocarbons!
- ❑ Do not spill cleaning liquid over the instrument!

9.2 Periodic calibration

It is essential that the test instrument is regularly calibrated in order that the technical specification listed in this manual is guaranteed. We recommend an annual calibration. Only an authorized technical personnel can do the calibration. Please contact your dealer for further information.

9.3 Service

For repairs under warranty, or at any other time, please contact your distributor.

10 Technical specifications

10.1 Resistance measurement

Test current	Resistance range	Resolution	Accuracy
2 A	0.000 ... 9.999 mΩ	1 μΩ	±(0.25 % of reading + 2 digits)
	10.00 ... 99.99 mΩ	10 μΩ	
	100.0 ... 999.9 mΩ	100 μΩ	
100 mA	0.00 ... 99.99 mΩ	10 μΩ	
	100.0 ... 999.9 mΩ	100 μΩ	
	1.000 ... 9.999 Ω	1 mΩ	
10 mA	10.00 ... 19.99 Ω	10 mΩ	
	0.0 ... 999.9 mΩ	100 μΩ	
	1.000 ... 9.999 Ω	1 mΩ	
	10.00 ... 99.99 Ω	10 mΩ	
	100.0 ... 199.9 Ω	100 mΩ	

Table 10.1: Resistance measurement ranges and accuracy

Test current accuracy ±10% (smoothed DC)

Test duration..... 1 s (single mode)

Test method..... 4-wire measurement

Note:

- All data regarding accuracy is given for nominal (reference) environment condition and forward and reverse measurements.
- Inductive mode will introduce an undefined error if an EMF is present on the test object.
- The error in operating conditions could be at most the error for reference conditions (specified in the manual for each function) + 0.1% of measured value + 1 digit, unless otherwise specified in the manual for particular function.

Noise rejection (50/60 Hz) on potential leads P1 - P2:

Test current	Max. noise level	Additional error
2 A	1.4 A _{RMS} (R _x < 500 mΩ)	≤ 0.5 %
100 mA	70 mA _{RMS} (R _x < 10 Ω)	
10 mA	7 mA _{RMS} (R _x < 100 Ω)	

10.2 Measurement parameters

Test current:	2 A	100 mA	10 mA
Max. power output:	4 W	0,2 W	20 mW
Output voltage:	9 V _{DC} max.		
Limits:	1 $\mu\Omega$... 199.9 Ω		

Table 10.2: Measurement parameters

10.3 Voltage and frequency

10.3.1 Voltage

Measuring range (V)	Resolution (V)	Accuracy
0.0 ÷ 49.9	0.1	±(2 % of reading + 2 digits)
50 ÷ 550	1	

Result type..... True r.m.s. (trms)

Nominal frequency range..... 0 Hz, 14 Hz ÷ 500 Hz

10.3.2 Frequency

Measuring range (Hz)	Resolution (Hz)	Accuracy
10.0 ÷ 99.9	0.1	±(0.2 % of reading + 1 digit)
100 ÷ 500	1	

Nominal voltage range..... 10 V ÷ 550 V

10.4 General data

Power supply voltage.....	9 V _{DC} (6×1.5 V battery or accu, size AA)
Idle state	> 25 h
Measurements	> 800 measurements of 500 mΩ load @ 2 A test current & 15 s measurement duration.
Charger socket input voltage	12 V ± 10 %
Charger socket input current	400 mA max.
Battery charging current	250 mA (internally regulated)
Overvoltage category.....	600 V CAT III / 300 V CAT IV
Protection classification	double insulation
Pollution degree.....	2
Protection degree	IP 40
Display	128 × 64 dots matrix display with backlight
Dimensions (w × h × d).....	14 cm × 8 cm × 23 cm
Weight	0.8 kg, without battery cells and accessories
Reference conditions	
Reference temperature range.....	25 °C ± 5 °C
Reference humidity range.....	40 %RH ÷ 70 %RH
Operation conditions	
Working temperature range	0 °C ÷ 40 °C
Maximum relative humidity	95 %RH (0 °C ÷ 40 °C), non-condensing
Storage conditions	
Temperature range	-20 °C ÷ +70 °C
Maximum relative humidity	90 %RH (-10 °C ÷ +40 °C) 80 %RH (40 °C ÷ 60 °C)
Nominal altitude	up to 2000m
RS232 interface	115200 bps, 1 start bit, 8 data bits, 1 stop bit
RS232 connector	PS/2 connector, female
USB interface	256000 bps
USB connector.....	type B
Memory	1500 storage locations (512 kB)
Real time clock error.....	± 50 ppm
Maximum lead resistance	100 mΩ total (C1 and C2)