



MicroOhm 100A
MI 3252
Instruction manual
Version 1.2.4; Code No. 20 751 784

Distributor:

Producer:

METREL d.d.
Ljubljanska 77
SI-1354 Horjul

Tel.: +386 1 75 58 200
Fax: +386 1 75 49 226
E-mail: metrel@metrel.si
<http://www.metrel.si>



Mark on your equipment certifies that this equipment meets the requirements of the EU (European Union) concerning safety and interference causing equipment regulations

© 2010 Metrel

No part of this publication may be reproduced or utilized in any form or by any means without permission in writing from METREL.

Table of contents

1	General description	4
1.1	Features	4
1.2	Applied Standards	4
2	Instrument Description	5
2.1	Instrument Casing	5
2.2	Operator's Panel	5
2.3	Accessories	7
2.4	Test leads	8
3	Warnings	9
4	Operating the instrument	10
4.1	Connecting the instrument	11
4.2	Basic instrument manipulation	13
4.3	Performing measurement	18
4.4	Storing, Recalling and Clearing Results	19
4.5	Transferring Data to a PC	20
5	Maintenance	21
5.1	Inspection	21
5.2	Charging the battery	21
5.3	Replacing the battery	22
5.4	Cleaning	24
5.5	Calibration	24
5.6	Fuses	24
5.7	Service	24
6	Technical specifications	25
6.1	General data	25
6.2	Measurement ranges and accuracy	26
6.3	Measurement parameters	26

1 General description

1.1 Features

MI 3252 MicroOhm 100A is a portable (weight < 12 kg) low resistance ohmmeter used to measure low contact resistances of breakers and switches, bus bars using test current from 100 mA to 100 A.

Instrument can be powered from mains or internal rechargeable battery.

The instrument is designed and produced with the extensive knowledge and experience acquired through many years of working in this sector.

Available functions offered by the **MicroOhm 100A** meter:

- Resistance measurement
 - wide measuring range (1 nΩ ... 20 Ω);
 - adjustable test current (100 mA ... 100 A).
- Voltage drop measurement
 - complies with the NEMA standard (AB 4-2009) which prescribes this test as part of the “inspection and preventive maintenance of molded case circuit breakers”.

A 320x240 dot matrix LCD offers easy-to-read results and all associated parameters. The operation is straightforward and clear to enable the user to operate the instrument without the need for special training (except reading and understanding this Instruction Manual).

Test results can be stored on the instrument. Companion PC software HVLink PRO enables transfer of measured results to PC where can be analysed or printed.

1.2 Applied Standards

Instrument operation:	IEC 62271-100; IEC 62271-1; IEEE C37.09-2007; ASTM B 539; NEMA AB 4-2009 Spain: EI Real Decreto 223/2008
Electromagnetic compatibility (EMC):	EN 61326-1 Class A
Safety:	EN 61010-1

2 Instrument Description

2.1 Instrument Casing

The instrument is housed in a plastic box that maintains water and dust protection.

2.2 Operator's Panel

The operator's panel is shown in the figure below.

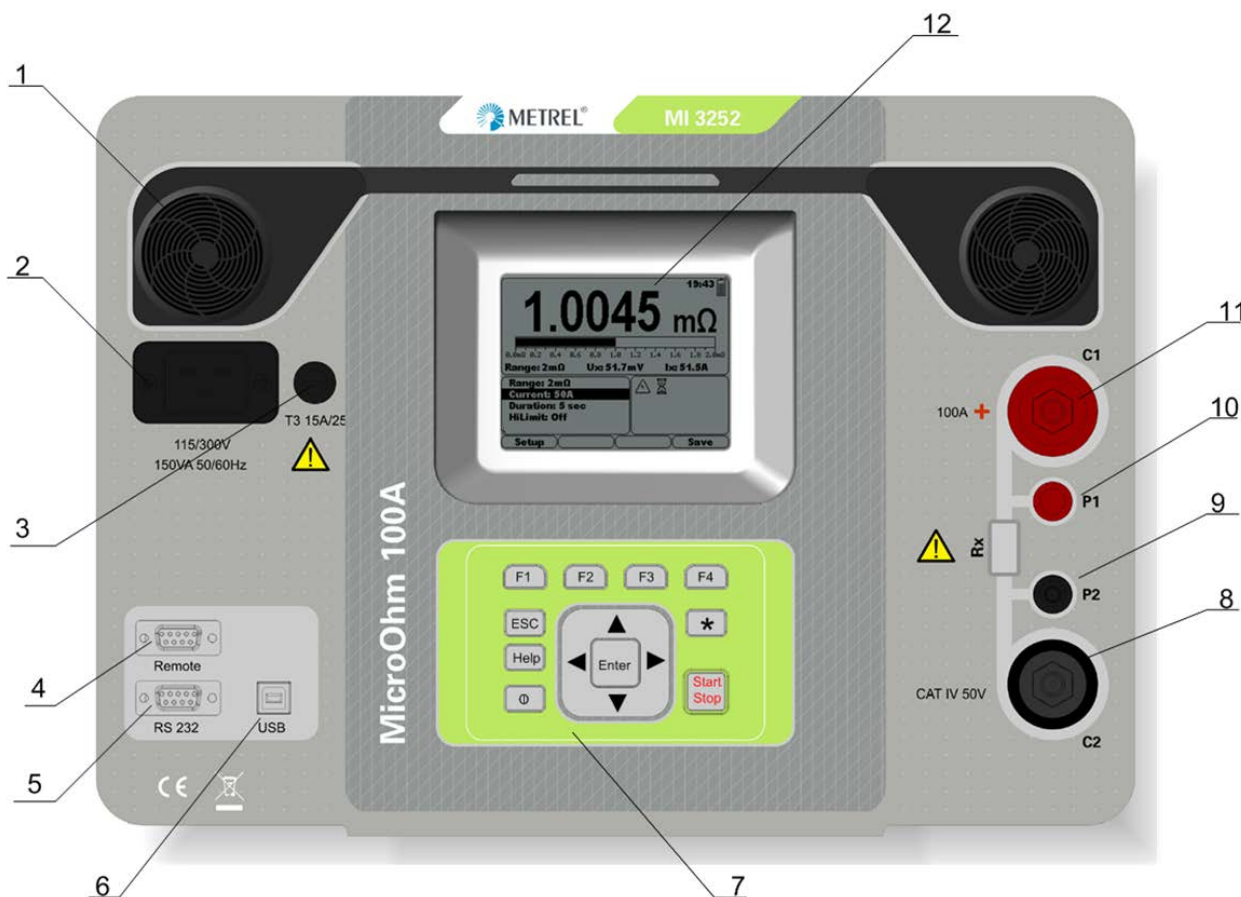









Figure 2.1: Front panel

	<p>Use original test accessories only! Max. allowed external voltage between test terminals and ground is 50 V! Max. allowed external voltage between test terminals is 50 V!</p>
--	---

Legend:

- 1 **Fans** for instrument cooling.
- 2 **Mains IEC Connector.**
- 3 **T3,15 A / 250 V fuse** for instrument protection.
- 4 **RS232 port** for remote control.
- 5 **RS232 port** for downloading recorded measurements.
- 6 **USB port** for downloading recorded measurements.
- 7 **Keyboard** for instrument manipulation:
- | | |
|---|---|
| ESC | key to exit the selected mode; |
|  | Light key to turn the display backlight ON or OFF; |
|  | Power On/Off switch; |
| Start/Stop | key to start and stop measurement; |
| Enter | key to enter set-up mode for the selected function or to select the active parameter to be set; |
| Help | key show basic guidelines how to use instrument; |
| F1 ... F4 | function keys are used to perform context actions; |
|  | cursor key to select an option upward; |
|  | cursor key to select an option downward; |
|  | cursor key to decrease the selected parameter; |
|  | cursor key to increase the selected parameter. |
- 8,11 **Current terminals (C1, C2).**
- 9,10 **Voltage terminals (P1, P2).**
- 12 **LCD display.**

Note:

- If you press and hold the **Light** () key for approximately 15s the instrument will **RESET!**

2.3 Accessories

The accessories consist of standard and optional accessories. Optional accessories can be delivered upon request. See *attached* list for standard configuration and options or contact your distributor or see the METREL home page: <http://www.metrel.si>.



Figure 2.2: Standard set of the instrument

- › Instrument MI 3252 MicroOhm 100A
- › Current test lead with crocodile clip, 5 m, 25 mm², 2 pcs
- › Potential test lead, 5 m, 2 pcs (black, red)
- › Crocodile clip, 2 pcs (black, red)
- › Test probe, 2 pcs (black, red)
- › Mains cable
- › RS232 serial cable
- › USB cable
- › Bag for accessories
- › PC SW HVLink PRO
- › Instruction manual
- › Calibration certificate

2.4 Test leads

The standard length of test leads is 5 m. For more details see attached list for standard configuration and options or contact your distributor.

2.4.1 Current test leads



Current lead set consists of pair of flexible high current capacity (100 A cont.) cable with 25 mm² cross area.

Current leads are fitted with heavy duty sprung clamps (60 mm jaw capacity).

2.4.2 Potential leads, clips, probes and test shunt



Potential lead set consist of pair of flexible cable with 1,5 mm² cross area (black, red).



Crocodile clips, 20 mm jaw capacity (black, red).



Potential test probes (black, red).

3 Warnings

In order to reach the highest level of operator's safety while carrying out various measurements and tests using the **MI 3252 MicroOhm 100A**, as well as to ensure that the test equipment remains undamaged, it is necessary to consider the following warnings:

MEANING OF SYMBOLS



Symbol on the instrument means "Read the Instruction Manual with special care!"

GENERAL PRECAUTIONS

- › If the test equipment is used in a manner not specified in this Instruction Manual, the protection provided by the equipment may be impaired!
- › Do not use the instrument and accessories, if any damage is noticed!
- › Service intervention or recalibration procedure can be carried out only by a competent and authorized person!
- › Front panel near fan, C1 and C2 connectors can overheat when performing long term measurements at 100A.

BATTERIES

- › Instrument has dry Lead Acid battery. It is designed to automatically charge and maintain battery capacity according to the use.

EXTERNAL VOLTAGES

- › Do not connect the instrument to a mains voltage different from the one defined on the label adjacent to the mains connector (CAT II 300 V), otherwise the instrument may be damaged.
- › Do not connect test terminals to any external voltage. Possible phantom voltage on test terminals should be not higher than 50 V DC or AC (CAT IV environment) in order to prevent any damage to the test instrument!

WORKING WITH THE INSTRUMENT

- › Use only standard or optional test accessories supplied by your distributor!
- › Make sure that the tested object is disconnected and discharged (mains voltage disconnected) before starting the Resistance measurement!
- › Do not touch the tested object whilst testing it, risk of electric shock!
- › Do not open circuit during Resistance measurement. In case of an inductive test object (long tested cable, coils etc.), hazardous voltage can appear on terminals!

4 Operating the instrument



The instrument is switched ON by pressing the  key. After turning on, instrument is ready for measurement.



Figure 4.1: Display and keyboard layout

Notes:

- If battery is defective and the instrument is powered from it, the instrument will not turn ON.
- If instrument temperature is extremely high, as consequence of many continuous measurements or high environment temperature, it will be not possible to perform measurements by pressing the START/STOP button. Overheat icon  will appear in message windows.

Mains powered instrument operation

If you connect instrument to the mains supply when instrument is turned OFF, internal charger will begin to charge the battery but instrument will remain turned OFF. In top right corner of LCD, charging battery indicator will appear and indicate that the battery is charging.

Battery powered instrument

If instrument is not connected to mains power supply, it will be self powered from internal battery. Battery capacity has enough energy for many hours of operation. Battery indicator in the right top corner indicates current status of battery. If battery capacity is low, instrument will indicate critical situation and refuse to start measurement.

Off function

The instrument can be switched OFF only by pressing the **ON/OFF** key. Instrument will continue to charge battery and show its status on the screen if connected to the mains power supply.

Note:

- It is not recommended to connect or disconnect the instrument to mains supply while the instrument is measuring resistance.

Backlight operation

After turning the instrument ON the LCD backlight is automatically turned ON. It can be turned OFF and ON by simply clicking the **LIGHT** key.

4.1 Connecting the instrument

In order to accurately measure resistance, the instrument has separate current and voltage terminals (four wire Kelvin method).

- C1 and C2 - Current terminals.
- P1 and P2 - Potential terminals.



Figure 4.2: MicroOhm current and voltage terminals

Typically MicroOhm 100A instrument is used to measure circuit breaker resistance or bus bar joints resistance. A connection diagram for those devices is shown on figures below.

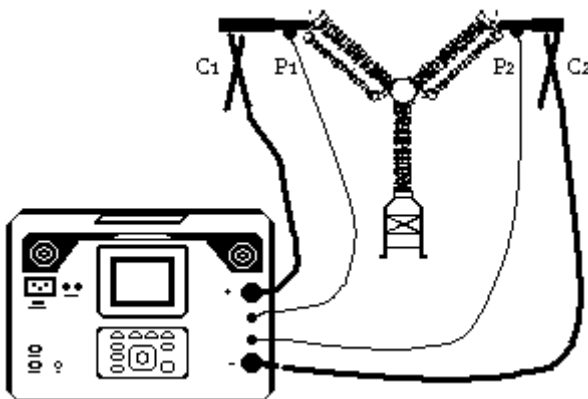

Figure 4.3: Circuit breaker connection

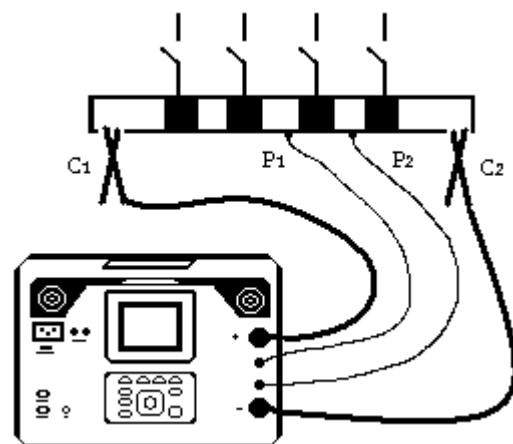

Figure 4.4: Bus bar connection

Note:

- The connections are also available in the help menu. To enter help menu simply press the **HELP** key on the front panel.

Four wire Kelvin method

When measuring resistance $<20\Omega$ it is advisable to use a four wire measurement technique (Figure 4.5), for achieving high accuracy. By using this type of measurement configuration the test lead resistance is not included in the measurement, and the need for lead calibrating and balancing is eliminated.

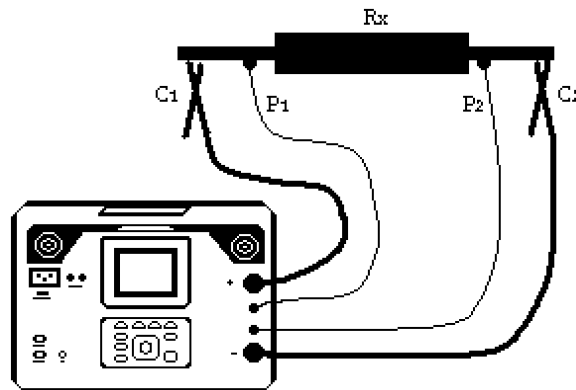

Figure 4.5: Connecting instrument to the measured device

The measuring current is passed through the unknown resistance R_x using the C1 and C2 leads. The placing of these leads is not critical but should always be outside the P1 and P2 leads. The Volt drop across the R_x is measured across P1 and P2 and these should be placed exactly at the points to be measured.

Poor Connection

Most measurement errors are caused by poor or inconsistent connection of the object under test. It is essential to ensure that the device under test has clean, oxide and dirt free contacts. High resistance connection will cause errors and may prevent the selected current to flow, because of the high resistance of C1 - C2 loop.

4.2 Basic instrument manipulation

Main screen after power up is shown on figure bellow. It is divided on 4 main parts.

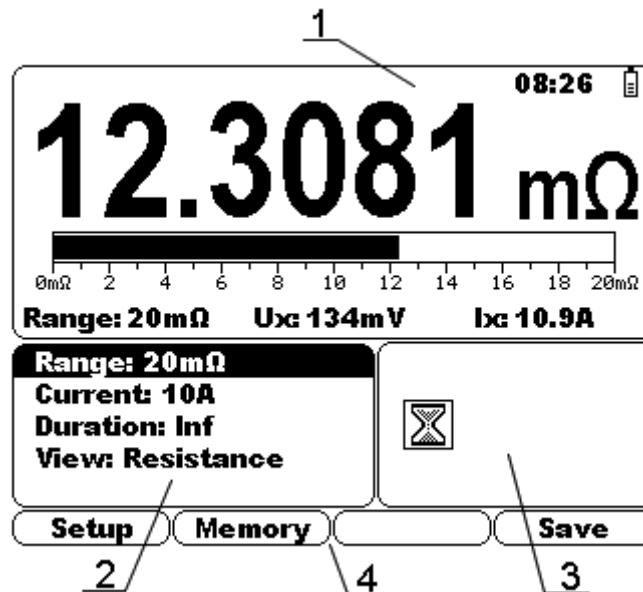

Figure 4.6: Main screen

- 1.... **Measurement result window**
- 2.... **Measurement control window**
- 3.... **Messages window**
- 4.... **Function keys**

In following chapter each of them is described in details.

Measurement result window

Measurement window show all relevant data during measurement campaign.

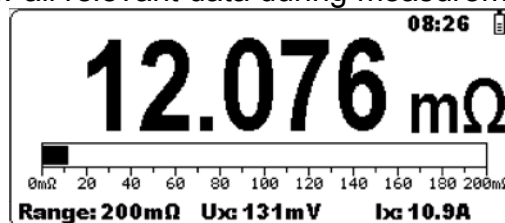

Figure 4.7: Measurement window

Measured resistance or voltage drop is shown in center of screen with the largest font. During measurement campaign this result is refreshed each few seconds. After finishing measurement result is hold on screen, until new measurement is started.

Bar graph graphically represents measured resistance in respect to the measurement range.

Range shows currently selected measuring range of resistance.

Ux shows voltage drop across measured resistance. During measurement campaign this result is refreshed each few seconds. After finishing measurement result is hold on screen, until new measurement is started.

Ix shows current flow through the measured resistance. During measurement campaign this result is refreshed each few seconds. After finishing measurement result is hold on screen, until new measurement is started.

Battery status



Battery capacity indication.

Lines across battery icon represent current battery capacity.



Recharging in progress (if external mains power supply is connected).

Whenever the main power supply is connected, the instrument will automatically start charging the battery. The instruments internal circuitry controls the charging and to ensure maximum battery life.

Time status

08:26

Time indication (hh:mm).

Notes:

- › Date and time is attached to each stored result.
- › If measured resistance is less than 10% of range it is recommended to decrease resistance range or increase current.

Measurement control window

Control window permit user to modify control measurement parameters.



Figure 4.8: Control window

Resistance range allows user to select desired measuring range. It is possible to select one of following ranges: 200 $\mu\Omega$, 2 m Ω , 20 m Ω , 40 m Ω , 100 m Ω , 200 m Ω , 2 Ω , 20 Ω . Note that resistance range depends on selected current. In example: with selected 100 mA current, only 2 Ω and 20 Ω ranges can be selected. See table 4.1 for more details.

Current allows user to select proper current for resistance measurement. It is possible to select one of following currents: 100 mA, 1 A, 10 A, 20 A, 50 A, 100 A.

Note:

- The MI 3252 uses a high efficiency current generator for generating currents $\geq 10A$. The current has a trapezoid shape.

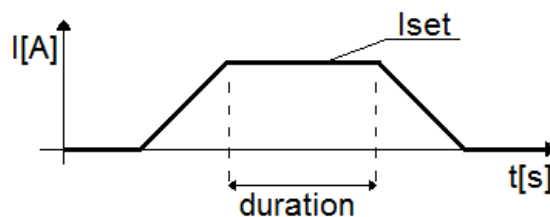

Figure 4.9: Trapezoid shape of the current

Measurement duration allows user to select time duration of measurement. It is possible to select one of following durations: 2 sec, 5 sec, 10 sec, 30 sec, 1 min, 2 min, 5 min, 10 min, inf. Using this parameter user can chose between **single** (2 sec) or **continuous** measurement (inf). During longer measurement campaign result of measurement is refreshed every few seconds.

View allows user to toggle between resistance (R_x) or voltage drop (U_x) measurement result shown in the center of the main screen.

Messages window

Messages window is used to show different status, warnings and errors.



Figure 4.10: Messages window



High voltage is present on terminals.



Measurement in progress.



Instrument is overheated. Measurement process is disabled.



High resistance (Low current). Measured current is lower than set current, which indicate that measured resistance is too high.



Battery low or mains power supply voltage is low.



The polarity of P1 and P2 wires on the test object is crossed.



Measurement result is within defined limits.



Measurement result is out of defined limits.



Measurement result is out of defined high limit.



Measurement result is out of defined low limit.

Function keys

Function window permit user to: setup up the instrument, enter the memory window and to save the result.



Figure 4.11: Function window

Settings Menu

In the Setup menu different parameters and settings of the instrument can be viewed or set.

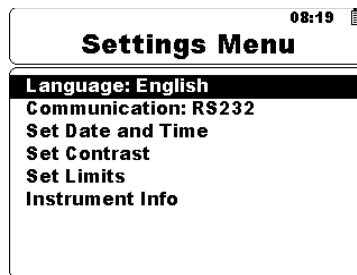

Figure 4.12: Setup menu

Language:

The instrument language can be set in this menu.

Communication:

Select between USB or RS232 communication.

Set Date and Time:

Date and Time can be set in this menu.

Set Contrast:

In this menu the contrast of the LCD can be set.

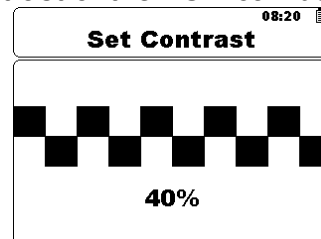

Figure 4.13: Contrast menu

Set Limits:

Upper and Lower limits allow user to set limit resistance values.

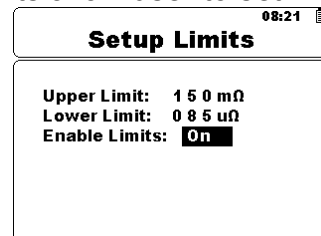

Figure 4.14: Limits menu

Measured resistance after measurement is compared against those limits. Result is validated only if it is within given limits.

Instrument Info:

In this menu the following instrument data is shown:

- › Hardware version;
- › Firmware version;
- › Serial No.;
- › Calibration date.

4.3 Performing measurement

Test can be started from the Main window. Before carrying out a test the parameters / limits can be edited.

Test procedure:

- ▶ Connect device under test to the instrument (see Figure 4.5).
- ▶ Set the test **Current**.
- ▶ Select the **Range**.
- ▶ Set the **Duration** of the test.
- ▶ Press the **START/STOP** key for measurement.
- ▶ Toggle the **View**: Resistance or Voltage Drop (optional).
- ▶ Store the result by pressing F4 key (optional).

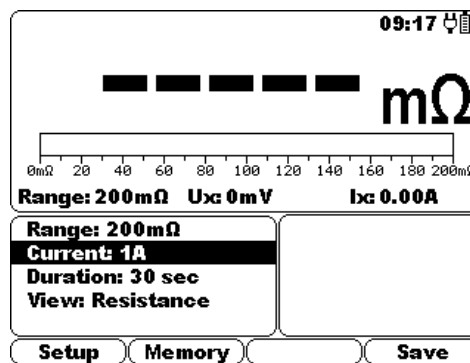

Figure 4.15: Main window

Keys:

▲ ▼	Selects a parameter.
◀ ▶	Changes a parameter.
Start / Stop	Start and stop measurement.

After the measurement is carried out the Resistance (Voltage Drop) result is displayed. The result can be stored by pressing the F4 button.

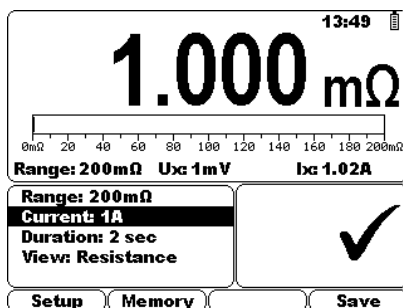

Figure 4.16: Resistance View

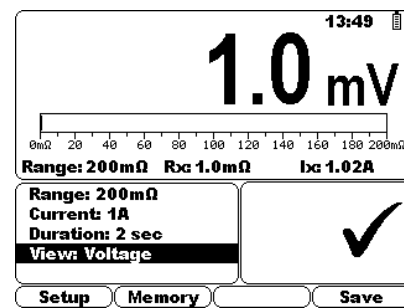

Figure 4.17: Voltage View

4.4 Storing, Recalling and Clearing Results

Measurement result with all relevant parameters can be stored into the instrument’s memory.

The instrument’s memory place is divided into 2 levels: Object and Number of Results. The Object level can contain up to 199 locations. The number of measurements stored under one object location is not limited.

Saving results

After the completion of a test, the results and parameters are ready for storing. By pressing the F4 key (Save), the user can store the result.

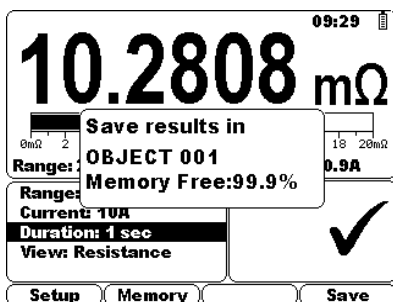

Figure 4.18: Storing Menu

The Object number can be decreased / increased by using cursor (◀ ▶) keys. Measurement will be stored under selected object, by pressing the F4 key (Save) again. The instrument will beep in order to indicate that result is successfully saved into the memory.

Note:

- Every stored test result includes also date and time stamp (dd:mm:yy, hh:mm).

Recalling, Deleting results

To recall or delete a test first select the proper object and then the proper test result number. By pressing the enter key the result will be recalled or deleted.

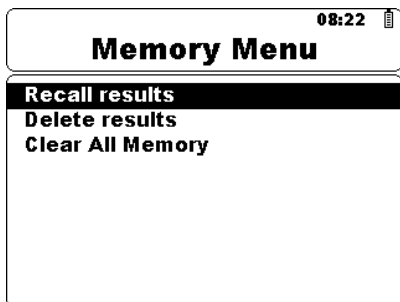

Figure 4.19: Memory Menu

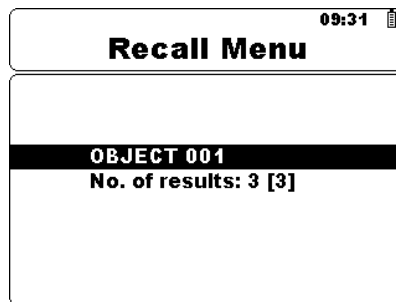

Figure 4.20: Recall Menu

Clearing complete memory content

When selecting the **Clear All Memory** function all the memory content will be deleted.

4.5 Transferring Data to a PC

Stored results can be transferred to a PC. A special communication program – **HVLink PRO** has the ability to identify the instrument and download the data.

How to transfer the stored data:

- Connect the instrument to the PC using the communication cable (RS232 or USB).
- Power up both the PC and the instrument.
- In the SETTINGS menu of the instrument (see Settings Menu section for details), set the communication mode (RS232 or USB). At the end leave the SETTINGS menu by pressing the ESC button.
- Run the HVLink PRO program on the PC. In the Settings / Com Port menu, set the appropriate Com Port. The Auto Find function can be used to configure Com port Settings automatically. If Auto Find function is not successful first time, try one more time.
- The PC and the instrument should automatically recognize each other.

With the **HVLink PRO** program, the following tasks can be performed:

- - download data;
- - display and change measured data;
- - prepare a simple report form;
- - export measurement for further use (spreadsheet program).

The program **HVLink PRO** is a **Windows 2000 / XP / VISTA™ / Windows7 (32bit or 64 bit)** compatible PC software.

Note:

- USB drivers should be installed on PC before using the USB interface (Windows 2000 / XP).

5 Maintenance

5.1 Inspection

To maintain the operator's safety and to ensure the reliability of the instrument it is advisable to inspect the instrument on a regular basis. Check that the instrument and its accessories are not damaged. If any defect is found please consult your service center, distributor or manufacturer.

5.2 Charging the battery

The instrument is designed to be powered by rechargeable battery or by mains supply. The LCD contains an indication of battery condition. When the low-battery indication appears (🔋) in message box the battery has to be recharged. Connect the instrument to the mains power supply for 20 hours to fully recharge battery. The typical charging current is 0,8 A.

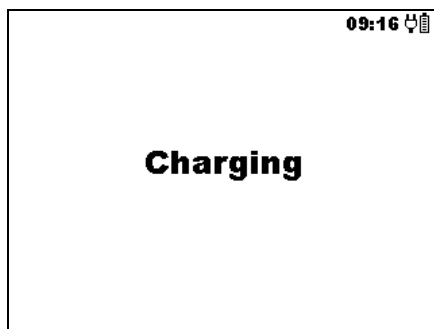

Figure 5.1: Charging Menu

Note:

- › The operator does not need to disconnect the instrument from mains supply after the full recharging period. The instrument can be connected permanently to the mains.

5.3 Replacing the battery

Battery can be replaced by user following disassembly guidelines:

1. Turn instrument upside down and remove screws as shown on figure bellow.

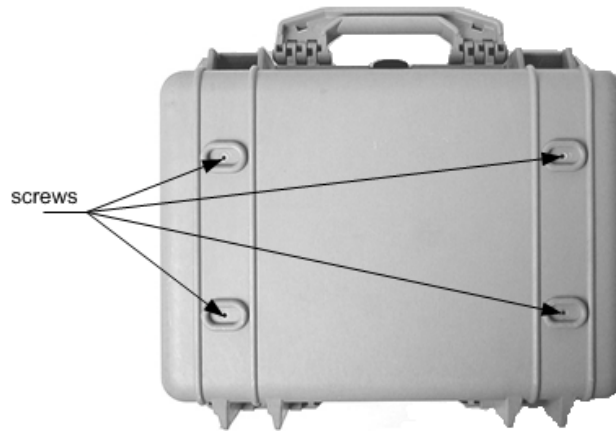

2. Pull out instrument front plate from suitcase.
3. Remove screws shown on figure bellow.

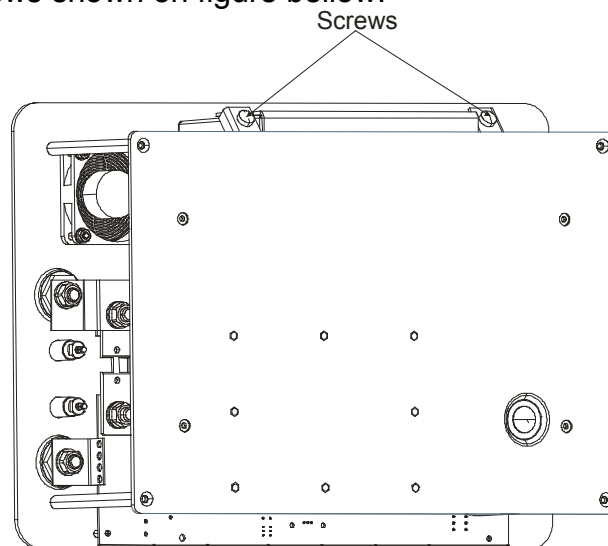

4. Remove screws, battery holder and carefully pull out battery.

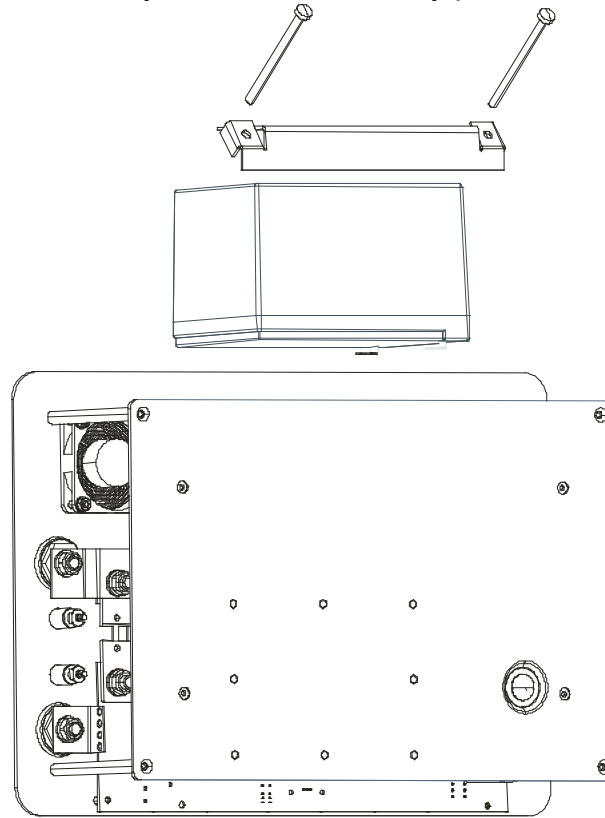

5. Replace battery (use Panasonic LC-CA1212P1 or similar) and reassemble the instrument.

Warning:

- If the battery is removed the time and date settings will be lost.

5.4 Cleaning

Use a soft cloth, slightly moistened with soapy water or spirit to clean the surface of the instrument and leave the instrument to dry totally before using it.

Notes:

- Do not use liquids based on petrol or hydrocarbons!
- Do not spill cleaning liquid over the instrument!

5.5 Calibration

It is essential that all measuring instruments are regularly calibrated in order for the technical specification listed in this manual to be guaranteed. We recommend an annual calibration. The calibration should be done by an authorized technical person only.

5.6 Fuses

There is one fuse available from front panel:

- T 3,15 A / 250 V (5 × 20 mm) intended for instrument main power supply circuit protection.

If the instrument does not respond after connection to mains supply, disconnect the mains supply and accessories and then check the fuses. For position of fuse refer to figure 2.1 (Front panel).

The other three fuses are located inside the instrument:

- T 2 A / 250 V (5 × 20 mm) for the battery charger protection circuit.
- T 16 A / 250 V (5 × 20 mm) for the battery protection.
- T 20 A / 250 V (5 × 20 mm) for the power supply circuit protection.

Warning!

- Switch off the instrument and disconnect all test accessories and mains cord before replacing the fuses or opening the instrument. Disconnect all test leads and the instrument mains cord before removing fuse cover!
- Replace blown fuse with the same type.

5.7 Service

For repairing under or out of warranty period contact your distributor for further information.

6 Technical specifications

6.1 General data

Reference conditions

Reference temperature range: 10 °C ... 30 °C
 Reference humidity range: 40 %RH ... 70 %RH

Operating conditions

Working temperature range: -10 °C ... 50 °C
 Maximum relative humidity: 95 %RH (0 °C ... 40 °C), non-condensing
 Temperature coefficient: 80 ppm / °C

Storage conditions

Temperature range: -10 °C ... +70 °C
 Maximum relative humidity: 90 %RH (-10 °C ... +40 °C)
 80 %RH (40 °C ... 60 °C)

Communication and memory

Memory: 1000 storage locations (512 kB)
 RS232 interfaces: 115.2 kbps (1 start bit, 8 data bits, 1 stop bit)
 USB interface: Serial port emulation, 115.2 kbps
 USB connector: type B
 Real time clock: ± 50 ppm

Battery and charging

Battery type: Panasonic LC-CA1212P1 (12 V_{DC}, 12 Ah)
 Battery charging current: 0,8 A (internally controlled)
 Battery charging time: 20 h
 Battery operation time: In standby: > 80 h
 In measurement: >2000 measurement of 4mΩ load with 50A @ 2s measurement duration.

Mains power supply

Mains voltage: 115 / 230 V_{AC} +10%, -5% (50 or 60 Hz)
 Max. power consumption: 200 VA

Protection

Overvoltage category: Measuring side: CAT IV / 50 V
 Mains power supply side: CAT II / 300 V
 Pollution degree: 2
 Protection degree: IP 64 (case closed)
 IP 30 (case opened)

Mechanics

Display: LCD 320 x 240 B&W
 Dimensions: 410 mm × 175 mm × 370 mm
 Case: shock proof plastic / portable
 Weight: 11,8 kg

6.2 Measurement ranges and accuracy

Resistance measurement

Test current	Resistance Range	Resolution	Accuracy
100 A	10,000 $\mu\Omega$... 199,999 $\mu\Omega$	1 n Ω	$\pm 0,25\%$ of reading
	0,20000 m Ω ... 1,99999 m Ω	10 n Ω	$\pm 0,25\%$ of reading
50 A	0,20000 m Ω ... 1,99999 m Ω	10 n Ω	$\pm 0,25\%$ of reading
	2,0000 m Ω ... 39,9999 m Ω	100 n Ω	$\pm 0,25\%$ of reading
20 A	2,0000 m Ω ... 19,9999 m Ω	100 n Ω	$\pm 0,25\%$ of reading
	20,000 m Ω ... 99,999 m Ω	1 $\mu\Omega$	$\pm 0,25\%$ of reading
10 A	2,0000 m Ω ... 19,9999 m Ω	100 n Ω	$\pm 0,25\%$ of reading
	20,000 m Ω ... 199,999 m Ω	1 $\mu\Omega$	$\pm 0,25\%$ of reading
1 A	20,000 m Ω ... 199,999 m Ω	1 $\mu\Omega$	$\pm 0,25\%$ of reading
	0,20000 Ω ... 1,99999 Ω	10 $\mu\Omega$	$\pm 0,25\%$ of reading
0,1 A	0,20000 Ω ... 1,99999 Ω	10 $\mu\Omega$	$\pm 0,25\%$ of reading
	2,0000 Ω ... 19,9999 Ω	100 $\mu\Omega$	$\pm 0,25\%$ of reading

Table 6.1: Resistance measurement ranges and accuracy

Voltage Drop measurement

Test current	Res. Range	Voltage Drop Range	Resolution	Accuracy
100 A	200 $\mu\Omega$	1,000 mV ... 20,000 mV	1 μV	$\pm 0,25\%$ of reading
	2 m Ω	20,00 mV ... 200,00 mV	10 μV	$\pm 0,25\%$ of reading
50 A	2 m Ω	10,00 mV ... 100,00 mV	10 μV	$\pm 0,25\%$ of reading
	40 m Ω	100,0 mV ... 2,0000 V	100 μV	$\pm 0,25\%$ of reading
20 A	20 m Ω	20,0 mV ... 400,0 mV	100 μV	$\pm 0,25\%$ of reading
	100 m Ω	200,0 mV ... 2,0000 V	100 μV	$\pm 0,25\%$ of reading
10 A	20 m Ω	20,0 mV ... 200,0 mV	100 μV	$\pm 0,25\%$ of reading
	200 m Ω	200,0 mV ... 2,0000 V	100 μV	$\pm 0,25\%$ of reading
1 A	200 m Ω	20,0 mV ... 200,0 mV	100 μV	$\pm 0,25\%$ of reading
	2 Ω	200,0 mV ... 2,0000 V	100 μV	$\pm 0,25\%$ of reading
0,1 A	2 Ω	200,0 mV ... 2,0000 V	100 μV	$\pm 0,25\%$ of reading
	20 Ω	200,0 mV ... 2,0000 V	100 μV	$\pm 0,25\%$ of reading

Table 6.2: Voltage Drop measurement ranges and accuracy

Test current accuracy: $\pm 10\%$ (smoothed DC).

Notes:

- For the values below 10% of the range, accuracy is $\pm 0,025\%$ of the full scale.
- All data regarding accuracy is given for nominal (reference) environment condition.

6.3 Measurement parameters

Test current:	0,1 A	1 A	10 A	20 A	50 A	100 A
Test Duration:	2s, 5s, 10s, 30s, 1min, 2min, 5 min, 10min, inf.					2s, 5s, 10s, 30s, 1min, 2min, 5 min, 10min
Output voltage:	3 V_{DC} max.		2,5 V_{DC} max.		1,5 V_{DC} max.	
Limits:	10 $\mu\Omega$... 20 Ω					

Table 6.3: Measurement parameters

