

FLUKE®

805/805 FC

Vibration Meter

Users Manual

May 2012, Rev. 2, 12/14

© 2012-2014 Fluke Corporation. All rights reserved. Specifications are subject to change without notice.
All product names are trademarks of their respective companies.

LIMITED WARRANTY AND LIMITATION OF LIABILITY

Each Fluke product is warranted to be free from defects in material and workmanship under normal use and service. The warranty period is one year and begins on the date of shipment. Parts, product repairs, and services are warranted for 90 days. This warranty extends only to the original buyer or end-user customer of a Fluke authorized reseller, and does not apply to fuses, disposable batteries, or to any product which, in Fluke's opinion, has been misused, altered, neglected, contaminated, or damaged by accident or abnormal conditions of operation or handling. Fluke warrants that software will operate substantially in accordance with its functional specifications for 90 days and that it has been properly recorded on non-defective media. Fluke does not warrant that software will be error free or operate without interruption.

Fluke authorized resellers shall extend this warranty on new and unused products to end-user customers only but have no authority to extend a greater or different warranty on behalf of Fluke. Warranty support is available only if product is purchased through a Fluke authorized sales outlet or Buyer has paid the applicable international price. Fluke reserves the right to invoice Buyer for importation costs of repair/replacement parts when product purchased in one country is submitted for repair in another country.

Fluke's warranty obligation is limited, at Fluke's option, to refund of the purchase price, free of charge repair, or replacement of a defective product which is returned to a Fluke authorized service center within the warranty period.

To obtain warranty service, contact your nearest Fluke authorized service center to obtain return authorization information, then send the product to that service center, with a description of the difficulty, postage and insurance prepaid (FOB Destination). Fluke assumes no risk for damage in transit. Following warranty repair, the product will be returned to Buyer, transportation prepaid (FOB Destination). If Fluke determines that failure was caused by neglect, misuse, contamination, alteration, accident, or abnormal condition of operation or handling, including overvoltage failures caused by use outside the product's specified rating, or normal wear and tear of mechanical components, Fluke will provide an estimate of repair costs and obtain authorization before commencing the work. Following repair, the product will be returned to the Buyer transportation prepaid and the Buyer will be billed for the repair and return transportation charges (FOB Shipping Point).

THIS WARRANTY IS BUYER'S SOLE AND EXCLUSIVE REMEDY AND IS IN LIEU OF ALL OTHER WARRANTIES, EXPRESS OR IMPLIED, INCLUDING BUT NOT LIMITED TO ANY IMPLIED WARRANTY OF MERCHANTABILITY OR FITNESS FOR A PARTICULAR PURPOSE. FLUKE SHALL NOT BE LIABLE FOR ANY SPECIAL, INDIRECT, INCIDENTAL, OR CONSEQUENTIAL DAMAGES OR LOSSES, INCLUDING LOSS OF DATA, ARISING FROM ANY CAUSE OR THEORY.

Since some countries or states do not allow limitation of the term of an implied warranty, or exclusion or limitation of incidental or consequential damages, the limitations and exclusions of this warranty may not apply to every buyer. If any provision of this Warranty is held invalid or unenforceable by a court or other decision-maker of competent jurisdiction, such holding will not affect the validity or enforceability of any other provision.

Fluke Corporation
P.O. Box 9090
Everett, WA 98206-9090
U.S.A.

Fluke Europe B.V.
P.O. Box 1186
5602 BD Eindhoven
The Netherlands

11/99

To register your product online, visit register.fluke.com

Table of Contents

Title	Page
Introduction	1
How to Contact Fluke	1
Safety Information.....	2
Symbols	3
Accessories	3
Specifications	3
Before You Start	5
Unpack and Inspect	5
Storage	5
Battery	5
Controls and Connections.....	6
Measurement Status LEDs	7
Power On	8
Power Off	8
How to Operate.....	9
Navigation	9
Meter Configuration	9
Units	10
Time	10
Date	11

Backlight Timeout.....	11
Language	11
Device Info	12
Battery Selection	12
Emissivity Selection.....	12
Power Saving.....	13
Flashlight.....	13
Accessory Connectors	13
External Sensor.....	14
Audio (805 only)	15
USB.....	16
About Measurements.....	17
Crest Factor+ (High Frequency Measurement).....	18
Quick Measurement.....	19
Overall Vibration (Low Frequency) Measurement with Severity Scale.....	20
Machine Category	21
Create New Setup.....	22
Add to Setup	24
Enable Fluke Connect (805 FC only)	24
How to Save a Measurement.....	25
Auto Save.....	25
Save to Existing Setup	25
Save to Current Setup.....	26
Save to New Setup.....	26
How to Recall a Setup for Measurements.....	27
Access to Memory	28
View All Data.....	28
View Setups.....	29
Edit Setups.....	29
Clear All Data	30
Interpret Results	31
Severity Scale	31
ISO 10816 Standards.....	32
Trending.....	32

ISO 10816-1.....	32
ISO 10816-3.....	33
ISO 10816-7.....	33
Export Data.....	34
General Maintenance	37
Care	37
How to Clean	37
Battery Replacement	38
Firmware Upgrades	39
How to Troubleshoot.....	40

List of Tables

Table	Title	Page
1.	Symbols	3
2.	Accessories	3
3.	Keypad and Connectors	6
4.	LED Status.....	7
5.	Crest Factor+	18
6.	Severity Scale.....	31
7.	Vibration Severity - ISO 10816-1	32
8.	Troubleshooting	40

List of Figures

Figure	Title	Page
1.	Meter Controls and Connections	6
2.	Flashlight	13
3.	External Sensor Connection (805).....	14
4.	Audio Connection (805 only).....	15
5.	Meter to PC Connection (805)	16
6.	Measurement Display	17
7.	Import Database	34
8.	Plot Options	35
9.	Data Plot Graph	36
10.	Battery Replacement	38

Introduction

The 805/805 FC Vibration Meter (the Meter or Product) is a screening tool for bearings and overall vibration measurements on machines. The Meter includes these features:

- Overall vibration measurement
- Bearing health measurement with Crest Factor+
- On-screen severity scales
- Acceleration, Velocity, and Displacement units of measure
- Temperature measurement with spot IR sensor
- Test results export to MS Excel template
- Belt Holster
- IP54
- Language support for Chinese (Simplified), Danish, Dutch, English, Finnish, French, German, Italian, Japanese, Norwegian, Portuguese (Brazilian), Russian Spanish, Swedish, and Turkish
- Audio output (805 only)
- Flashlight
- Stores up to 3,500 records
- USB support
- Storage/shipping case
- External accelerometer support
- Wireless data transmission of most recent measurement for use with Fluke Connect™ Phone App (805 FC only)

How to Contact Fluke

To contact Fluke, call one of the following telephone numbers:

- Technical Support USA: 1-800-44-FLUKE (1-800-443-5853)
- Calibration/Repair USA: 1-888-99-FLUKE (1-888-993-5853)
- Canada: 1-800-36-FLUKE (1-800-363-5853)
- Europe: +31 402-675-200
- Japan: +81-3-6714-3114
- Singapore: +65-6799-5566
- Anywhere in the world: +1-425-446-5500

Or, visit Fluke's website at www.fluke.com.

To register your product, visit <http://register.fluke.com>.

To view, print, or download the latest manual supplement, visit <http://us.fluke.com/usen/support/manuals>.

Safety Information

A Warning identifies the conditions and procedures that are dangerous to the user. A Caution identifies the conditions and procedures that can cause damage to the Product or the equipment under test.

Warning

To prevent possible electrical shock, fire, or personal injury:

- Carefully read all instructions.
- Do not touch hazardous voltages with the Product. These voltages could cause injury or death.
- Use the Product only as specified, or the protection supplied by the product can be compromised.
- Examine the case before you use the Product. Look for cracks or missing plastic.
- Make sure the battery is securely in position before operation.
- Do not use the Product around explosive gas, vapor, or in damp or wet environments.

- Comply with local and national safety codes. Use personal protective equipment (approved rubber gloves, face protection, and flame-resistant clothes) to prevent shock and arc blast injury where hazardous live conductors are exposed.

To prevent personal injury from the infrared thermometer:

- See emissivity information for actual temperatures. Reflective objects result in lower than actual temperature measurements. These objects pose a burn hazard.
- Do not keep the product in operation and unattended at high temperatures.









To prevent personal injury when near rotating equipment:

- Use caution around rotating equipment.
- Keep cords and straps contained.

Symbols

Table 1 is a list of symbols on the Meter and in this manual.

Table 1. Symbols

Symbol	Description
	Important information. See manual.
	Hazardous voltage.
	Conforms to requirements of European Union and European Free Trade Association.
	Conforms to relevant Australian EMC standards
	This product complies with the WEEE Directive (2002/96/EC) marking requirements. The affixed label indicates that you must not discard this electrical/electronic product in domestic household waste. Product Category: With reference to the equipment types in the WEEE Directive Annex I, this product is classed as category 9 "Monitoring and Control Instrumentation" product. Do not dispose of this product as unsorted municipal waste. Go to Fluke's website for recycling information.
	Battery or battery compartment.
	Low battery when shown on display.
	Conforms to relevant South Korean EMC standards.

Accessories

Table 2 is a list of the accessories available for the Meter.

Table 2. Accessories

Description	PN
Belt Holster	4106625
Storage/Shipping Case	4094432
Battery Door	4059351
USB Cable	3563901

For radio frequency certification, see www.fluke.com.

Specifications

Sensor

Sensitivity (typical)	100 mV / g ±10 %
Measurement Range	0.01 g to 50 g
Frequency Range	10 Hz to 1,000 Hz and 4,000 Hz to 20,000 Hz
Resolution	0.01 g
Accuracy (typical).....	At 100 Hz: ±5 % of measured value

Amplitude Units

Acceleration	g, m/sec ²
Velocity	in/sec, mm/sec
Displacement	mils, μm

Infrared Thermometer

Temperature Measurement	
Range	-20 °C to 200 °C (-4 °F to 392 °F)
Accuracy (typical)	
-20 °C to 120 °C (-4 °F to 248 °F)	±2 °C (4 °F)
120 °C to 160 °C (248 °F to 320 °F)	±3 °C (6 °F)
160 °C to 200 °C (320 °F to 392 °F)	±4 °C (7 °F)

Note

The specified accuracy is applicable only when the Meter is in thermal equilibrium with its environment. Accuracy is not specified when the target temperature is more than 20 °C (36 °F) below the temperature of the Meter.

Focal length	Fixed, at ~3.8 cm (1.5 in)
--------------------	----------------------------

External Sensor

Frequency Range	10 Hz to 1,000 Hz
Bias Voltage (to supply power)	20 V DC to 22 V DC
Bias Current (to supply power)	5 mA

Note

Fluke supports, but does not provide, external sensors.

Vibration Meter

Low Frequency Range (overall measurement)	10 Hz to 1,000 Hz
High Frequency Range (CF+ measurement)	4,000 Hz to 20,000 Hz
Vibration Limit	50 g peak (100 g peak-peak)
Battery Type	AA (2) lithium non-rechargeable 3 V dc

Battery Life

805	250 measurements
805 FC, Fluke Connect™ enabled ..	210 measurements

A/D Converter	16-bit
---------------------	--------

Sampling Rate

Low Frequency	20,000 Hz
High Frequency	80,000 Hz

Signal to Noise Ratio	80 dB
-----------------------------	-------

Real Time Clock Backup	Coin Battery
------------------------------	--------------

Size (L x W x H)	24.1 cm x 7.1 cm x 5.8 cm (9.5 in x 2.8 in x 2.3 in)
------------------------	---

Weight	0.40 kg (0.89 lb)
--------------	-------------------

Connectors (805)	USB Mini-B 7-pin, Stereo Audio Output Jack (3.5 mm Audio Plug), External Sensor Jack (SMB connector)
------------------------	---

Connectors (805 FC)	USB Mini-B 7-pin, External Sensor Jack (SMB connector)
---------------------------	---

Firmware

External Interfaces	USB 2.0 (full speed) communication
---------------------------	---------------------------------------

Data Capacity	Database on internal flash memory
---------------------	-----------------------------------

Upgrade	through USB
---------------	-------------

Memory	Up to 3,500 measurements
--------------	--------------------------

Environmental

Operating Temperature	-20 °C to 50 °C (-4 °F to 122 °F)
-----------------------------	-----------------------------------

Storage Temperature	-20 °C to 60 °C (-4 °F to 140 °F)
---------------------------	-----------------------------------

Operating Humidity	10 % to 95 % RH (non- condensing)
--------------------------	--------------------------------------

Operating/Storage Altitude	Sea Level to 3,048 meters (10,000 feet)
IP Rating	IP54
Vibration Limit	500 g peak
Drop Test	1 meter

Electromagnetic Environment

IEC 61326-1: Portable	
FCC	CFR Title 47, Part 15, Subpart B
Korea (KCC)	Class A Equipment (Industrial Broadcasting & Communication Equipment)

This product meets requirements for industrial (Class A) electromagnetic wave equipment and the seller or user should take notice of it. This equipment is intended for use in business environments and is not to be used in homes.

Before You Start

This section helps you to know the Meter parts, controls, connections, and status LEDs.

Unpack and Inspect

Carefully unpack and inspect the:

- Vibration Meter
- Storage case
- USB Cable
- Quick Reference Guide
- Belt Holster
- AA (2) Lithium non-rechargeable batteries

Storage

When not in use, always keep the Meter in the supplied storage case. The custom interior of the case supplies protection for the Meter, documentation, and accessories.

Battery

Before you use the Meter for the first time, install the two AA lithium non-rechargeable batteries (included). See *Battery Replacement* on page 38 for more information. The Meter also operates on two AA alkaline (3 V) batteries. Due to short battery life, alkaline batteries are not recommended.

Note

*Set the battery type in the Device Settings menu.
See page 12.*

 shows on the display when battery power is low. Replace the batteries before you continue to use the Meter.

Controls and Connections

Figure 1 shows the location of the controls and connections for the Meter. Table 3 is a key.



ggi01.eps

Figure 1. Meter Controls and Connections

Table 3. Keypad and Connectors

Item	Control
①	LCD
②	Power on/off
③	Measure
④	Navigation
⑤	Enter
⑥	Save
⑦	Setup
⑧	Connector cover
⑨	Status LED
⑩	Memory
⑪	Flashlight on/off
⑫	Backlight on/off
⑬	USB port
⑭	External sensor port
⑮	Audio port (805 only)
⑯	Vibration sensor
⑰	IR temperature sensor
⑱	Flashlight

Measurement Status LEDs

The Meter has a status light for visual feedback about the measurement. Green and red LEDs show the measurement status and that a good measurement has been taken. Table 4 is a list of the status as the LED changes color.

Table 4. LED Status

Status	Description
Green Off	Push MEASURE . Meter is ready for data measurement.
Green On	Push the sensor tip onto the test surface, on solid metal, as close as possible to the bearing. Apply the compression force until green LED is off.
Green Off	Data measurement is complete.
Red On	Error, insufficient force or time duration, no data measurement.

Power On

Push **ⓘ** to turn on the Meter. See Table 3 for the control location.

Note

Before you use the Meter for the first time, install the new batteries (see Battery Replacement on page 38).

When the Meter is turned on, the default Measurement screen shows on the Meter.

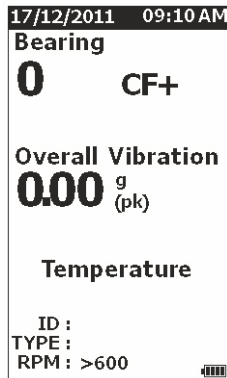

gqi49.jpg

Power Off

A soft shutdown is the preferred method to turn off the Meter:

1. Push **ⓘ**.
2. At the prompt, select **Yes**.
3. Or, select **No** to continue with operation.

If the Meter locks up or becomes inoperable, a hard shutdown can be used to turn off the Meter:

Note

Use a hard shutdown only as a last recourse as it can cause data loss. After a hard shutdown, start the Meter and verify the data in Memory.

1. Push and hold **ⓘ** for more than 2 seconds.
2. Push **ⓘ** to restart the Meter.





If Meter does not restart or the problem persists, contact Fluke.

How to Operate

This section is about the operation of the Meter. It includes measurement tips and step-by-step instructions.

Navigation

For general operation:

-  moves the cursor through the menu options and edits the options
-  opens next menu or sets the selection
-  updates the Meter with a new selection setting
-  recalls the previous menu







Each menu has navigation hints for its content at the bottom of the screen.

Meter Configuration

The Setup menu is how you change the configuration of the Meter. You can change these Device Settings:

- Units
- Time
- Date
- Backlight Timeout
- Language
- Device Info
- Battery Selection

To open Device Settings:

1. Push  to view the Setup screen.
2. Push  and  to highlight **Device Settings** from the menu. This opens a list of all available options.
3. Push  to open the menu.
4. Push  and  to highlight an option.
5. Push  to open the menu.

Units

The units of measure are adjustable for different standards.

To set from the Device Settings menu:

1. Push **▼** and **▲** to highlight **Units**.
2. Push **ENTER** to open menu for units. The current setting is highlighted.
3. Push **▼** and **▲** to highlight the unit to change.
4. Push **ENTER** to open menu with options for that unit. The current setting is highlighted.
5. Push **SAVE** to update the Meter and exit the menu.
6. Push **◀** and **▶** to move to the next page for more options.

Time

To set the time format:

1. Push **◀** and **▶** to highlight the format as **12 hr** or **24 hr**.
2. Push **ENTER** to set the option.

To set the time:

1. Push **▼** **▲** **▶** and **◀** to highlight hour, minute, or second.
2. Push **ENTER** to enable the edit.
3. Push **▼** and **▲** to make a change.
4. Push **ENTER** to set the option.
5. Push **▼** **▲** **▶** and **◀** to highlight **am** or **pm**.
6. Push **ENTER** to set the option.

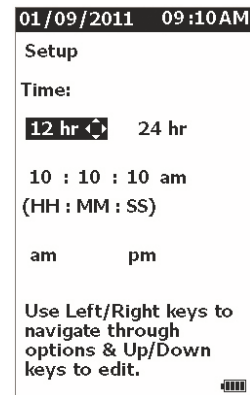



7. Push **SAVE** to update the Meter and exit the menu.



gqi57.jpg

Date

To change the date format:

1. Push  and  to highlight the option for **MM/DD/YYYY** or **DD/MM/YYYY**.
2. Push **ENTER** to set the option.

To change the date:



1. Push to highlight the option for Day, Month, and Year.
2. Push **ENTER** to edit the option.
3. Push  and  to make a change.
4. Push **ENTER** to set the change.
5. Push **SAVE** to update the Meter and exit the menu.

Backlight Timeout

The backlight turns off in a preset time limit. If you do not push a key during this time limit, the backlight turns off to extend battery power. To turn on the backlight, push a key.



You can also set the backlight as always on with the None option.

To change the backlight timeout:

1. Push  and  to highlight the option: **2 min**, **5 min**, **10 min**, or **None**.
2. Push **ENTER** to set the option.
3. Push **SAVE** to update the Meter and exit the menu.

Language

To change the language for the display:

1. Push  and  to highlight a language.
2. Push **ENTER** to set the option and exit the menu.
3. Push **SAVE** to update the Meter and exit the menu.

The display shows the new language.

Device Info

Information about your Meter is in the Device Info menu. This information includes the:

- Serial number
- Software version
- Emissivity value (See *Emissivity Selection* for more information on the emissivity value.)
- Internal sensor sensitivity
- Database Free Space

Battery Selection

To change the battery type:

1. Go to the **Device Settings** menu.
2. Push **▼** and **▲** to highlight **Battery Selection**.
3. Push **ENTER** to open the menu.
4. Push **▼** and **▲** to highlight the battery type you have in the Meter.
5. Push **SAVE** to update the Meter and exit the menu.

Emissivity Selection





The correct emissivity value is important for you to make the most accurate temperature measurements. Most painted or oxidized surfaces have an emissivity of 0.93 (default value set in the Meter). This is correct for non-contact temperature measurements on most bearing housings.

Inaccurate measurements can result from shiny or polished metal surfaces. To compensate, put masking tape or flat black paint on the measurement surface. Make sure that the tape is the same temperature as the measurement surface before you make a measurement.

For other applications the Meter has additional preset emissivity values:

- Aluminum (e=0.30)
- Iron (e=0.70)
- Steel (e=0.80)
- Paint (e=0.93) – *default value*
- Wood (e=0.94)
- Concrete (e=0.95)

To change the emissivity value:

1. Go to the **Device Settings** menu.
2. Push  and  to highlight **Material Emissivity**.
3. Push **ENTER** to open the menu.
4. Push  and  to highlight a value.
5. Push **SAVE** to update the Meter and exit the menu.

Power Saving

The Meter bypasses battery power when it is connected to a PC with the USB cable. The Meter then uses the PC power to extend its battery power.

Flashlight

The Meter has a built-in flashlight to illuminate the measurement area on the machine. Push  to turn on and off the flashlight. See Figure 2 for the location of this button.

Note

Flashlight operation for extended periods of time decreases battery life. Flashlight operation will affect a temperature measurement.

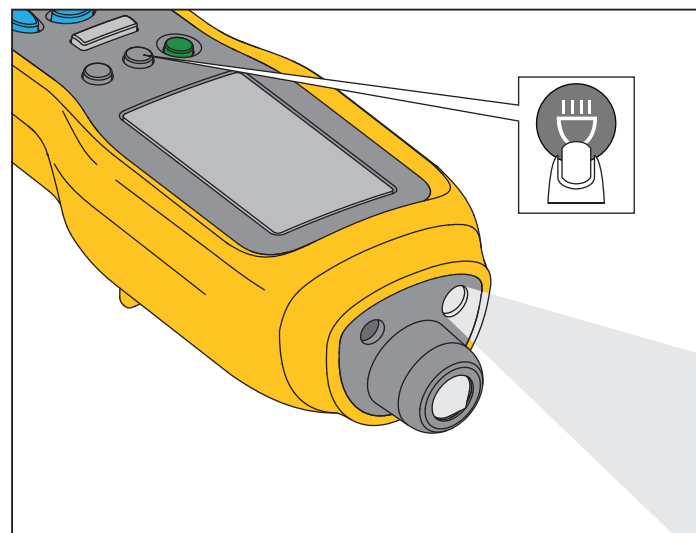

gqi06.eps

Figure 2. Flashlight

Accessory Connectors

The Meter has three accessory connectors:

- External Sensor
- Audio (805 only)
- USB

External Sensor

In addition to the integrated vibration sensor, an optional external sensor connects to the Meter. The connector type for the external sensor is a Subminiature version B (SMB). Figure 3 shows how to connect an external sensor to the Meter.

Note

Fluke supports, but does not provide, external sensors.

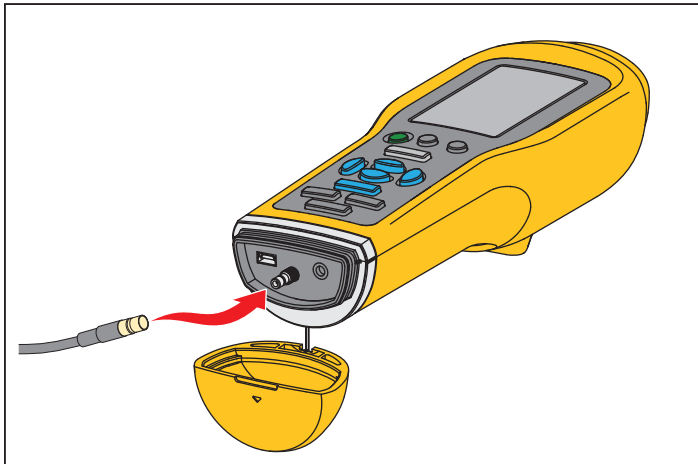

Figure 3. External Sensor Connection (805 shown)

Note

High frequency measurement (Crest Factor+) and Temperature measurement automatically turn off when an external sensor is connected to the Meter.

To connect:

1. Open the connector cover and push the external sensor into position.
2. Push **MEASURE** to open the Enter Sensitivity menu.

Note

You must set the sensitivity in mV/g units.

3. Use the navigation keys to select a character in the menu.
4. Push **ENTER** to input the character into the field.
5. Repeat steps 2 and 3 for additional characters.
6. Push **SAVE** to store the value in the Meter and exit the menu.
7. Push **MEASURE** to start data collection.

The Meter automatically detects when you disconnect the external sensor and is set to measure with the internal sensor.

Audio (805 only)

The Meter has an audio connector for headphones. Headphones are useful for detection of unusual machine sounds.

To listen to a machine:

1. Open the connector cap of the Meter and connect the audio connector.
2. Put on the headphones.
3. Push and continue to hold **MEASURE**.
4. Push the sensor tip onto the test surface.

As you continue to hold **MEASURE** and Meter position with a consistent force, the audio channel is active. The Meter also takes a measurement at this time.

Figure 4 shows how to make the audio connection to the Meter.

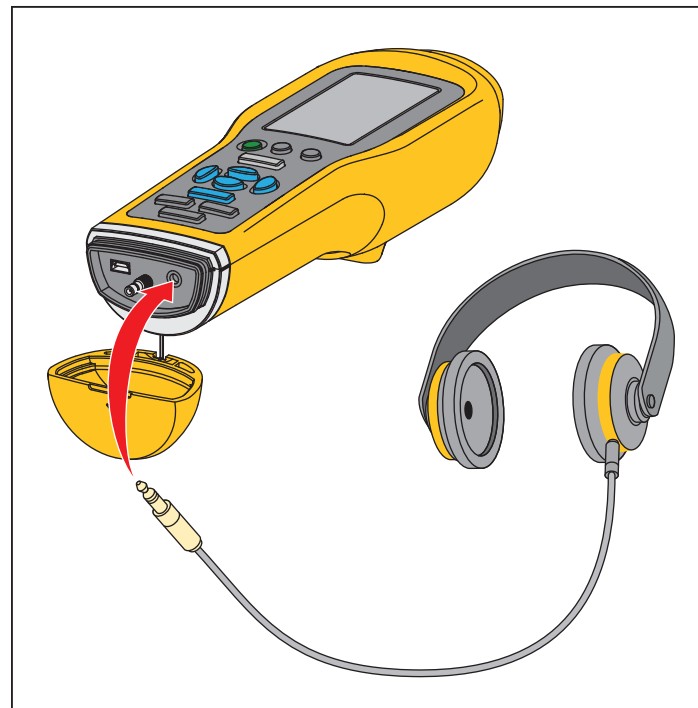

gqi04.eps

Figure 4. Audio Connection (805 only)

USB

Data transfer between the Meter and PC is through the USB cable connection. The Meter turns on and stays on when it is connected to the PC. Figure 5 shows how to connect a PC to the Meter with a USB cable. When connected, the Meter is a USB 2.0 mass storage device with two functions:

- to export Meter data to an MS Excel spreadsheet (see *Export Data* on page 34 for more information)
- to upgrade the firmware (see *Firmware Updates* on page 39 for more information)

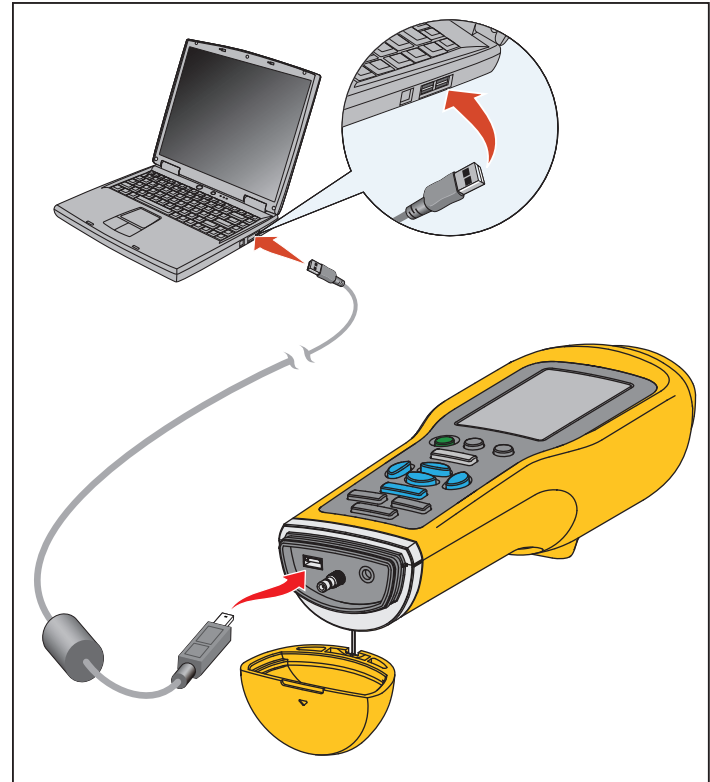

gqi03.eps

Figure 5. Meter to PC Connection (805 shown)

About Measurements

The Meter measures bearing health and the overall vibration condition of a machine. Three types of measurements are available: bearing vibration, overall vibration, and temperature. Vibration measurement units are user-selectable. More information about how to change these units is on page 9.

For the best measurements, use these guidelines:

- Push **MEASURE** and position the Meter perpendicular to the test surface.
- Push the sensor tip onto the test surface, on solid metal, and as close to the bearing as possible until the green LED turns on.
- Hold Meter in position with a consistent force until the green LED turns off. The test results show on the display.

In most applications the default RPM setting of >600 RPM is correct. You must change this range for low frequency applications where the shaft rotation is <600 RPM. A severity scale does not show on the display when the setting is <600 RPM. More information about how to change the RPM setting is on page 22.

Figure 6 identifies the parts of the measurement display.

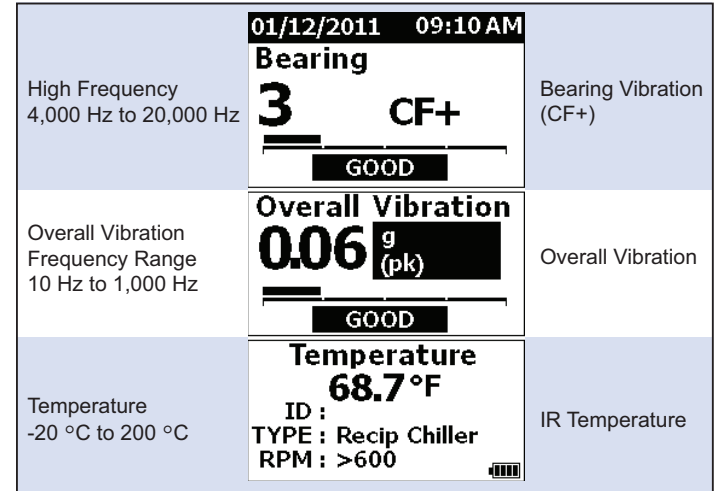

gqi10.eps

Figure 6. Measurement Display

Push **◀** and **▶** to toggle the display selection between Bearing and Overall Vibration measurements. In the Bearing selection, push **⬇** and **⬆** to toggle the display units between CF+ and acceleration. In the Overall Vibration selection, push **⬇** and **⬆** to toggle the display units between acceleration, velocity, and displacement.



Crest Factor+ (High Frequency Measurement)

Crest Factor is the ratio of the peak value / RMS value of a time domain vibration signal. Vibration analysts use this ratio to find bearing faults. However, the Crest Factor method has a key limitation. The Crest Factor increases during initial bearing degradation when the peak value increases. It then decreases as the bearing damage worsens and the RMS value increases. A low Crest Factor value could show a healthy bearing or a significantly degraded bearing. The problem is to know the difference between the two.

The Meter operates with a proprietary algorithm, Crest Factor+ (CF+), to overcome this limitation. To make interpretation easy for the user, the CF+ value shows a severity range. The higher the CF+ value is, the more the bearing damage. Table 5 shows the relationship of the values of CF+ to vibration severity.

Table 5. Crest Factor+

CF+	Severity
1 to 5	Good
6 to 10	Satisfactory
11 to 15	Unsatisfactory
above 15	Unacceptable

The CF+ value shows for each measurement in the Bearing field on the Meter display. Push  and  to toggle between the CF+ value and the high frequency vibration level in units of acceleration.

Quick Measurement

A quick measurement is a measurement without setup steps to get a fast measurement for bearing vibration, overall vibration, and temperature measurement.

To make a quick measurement:

1. Push **ⓘ** to turn on the Meter.
2. The default screen appears without any machine ID or Machine Category.
3. Push **MEASURE**.
4. Apply compression force between the sensor tip and test surface until the green LED turns on.
5. Wait until the green LED turns off and shows the test result.

The overall vibration and temperature measurements show on the display.

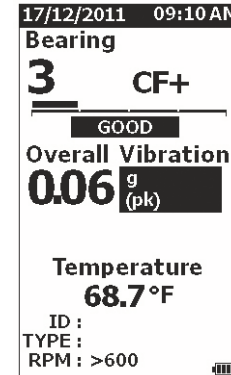

gqi48.jpg

Overall Vibration (Low Frequency) Measurement with Severity Scale

An overall vibration, or low frequency, measurement includes a severity scale. The severity scale is an on-screen tool that interprets the vibration wear as good, satisfactory, unsatisfactory, or unacceptable. More information about the severity scale is on page 31.

For this measurement, you must set the Meter to recognize the type of machine, or Machine Category, for the test. A list of the most common categories is programmed into the Meter. When the Meter is set to a category, it can adjust for the usual vibration levels of different machine types. This gives you the best accuracy in the severity scale.

After these parameters are set, the Meter shows the overall vibration and bearing measurements with a severity scale for each measurement. The overall vibration severity scale uses a statistical analysis of data from thousands of industrial machines. Keep in mind when you use the severity scales:

- The severity scales are only applicable to machines at speeds from 600 RPM to 10,000 RPM.

Note

Severity scales do not show if the RPM range is <600 RPM.

- Make measurements with the accelerometer as close as possible to the bearing housing.
- The severity scales are not applicable if the machine is installed on spring or pad isolators.
- Severity scales for motors match the machine that they operate. For example, when you do a test on a motor that operates a centrifugal pump, select the applicable centrifugal pump Machine Category for all test points on the motor and pump.
- Gearbox severity scales are applicable only for single-stage, rolling element bearing gearboxes.

Machine Category

The Machine Category identifies the type of machine for the test. The Meter has a list of predefined categories:

Chillers (Refrigeration)

- Reciprocating (Open Motor and Compressor Separate)
- Reciprocating (Hermetic Motor and Compressor)
- Centrifugal (Hermetic or Open Motor)

Fans

- Belt-Driven Fans 1800 to 3600 RPM
- Belt-Driven Fans 600 to 1799 RPM
- General Direct Drive Fans (Direct Coupled)
- Vacuum Blowers (Belt or Direct Drive)
- Large Forced Draft Fans (Fluid Film Brgs.)
- Large Induced Draft Fans (Fluid Film Brgs.)
- Shaft-Mounted Integral Fan (Extended Motor Shaft)
- Axial Flow Fans (Belt or Direct Drive)

Cooling Tower Drives

- Long, Hollow Drive Shaft (Motor)
- Belt Drive (Motor & Fan–All Arrangements)
- Direct Drive (Motor & Fan–All Arrangements)

Centrifugal Pumps

- Vertical Pumps (Height: 12 ft to 20 ft / 3.7 m to 6 m)
- Vertical Pumps (Height: 8 ft to 12 ft / 2.4 m to 3.7 m)
- Vertical Pumps (Height: 5 ft to 8 ft / 1.5 m to 2.4 m)
- Vertical Pumps (Height: 0 ft to 5 ft / 0 m to 1.5 m)

Note

Height is measured from grade to top motor bearing. It may be necessary to specify lower alarm for the lower motor bearing and the upper pump bearing (depending on height).

- Horizontal Centrifugal Single Suction Pumps - Direct Coupled
- Horizontal Centrifugal Double Suction Pumps- Direct Coupled
- Boiler Feed Pumps (Turbine or Motor Driven)

Air Compressors

- Reciprocating
- Rotary Screw
- Centrifugal with or without External Gearbox
- Centrifugal - Internal Gear (Axial Meas.)
- Centrifugal - Internal Gear (Radial Meas.)

Blowers

- Lobe-Type Rotary Blowers (Belt or Direct Drive)
- Multi Stage Centrifugal Blowers (Direct Drive)

Generic Gearboxes (Rolling Element Bearings)

- Single Stage Gearbox

Positive Displacement Pumps

- Positive Displacement Horizontal Piston Pumps (Under Load)
- Positive Displacement Horizontal Gear Pumps (Under Load)

Machine Tools

- Motor
- Gearbox Input
- Gearbox Output
- Spindles - Roughing Operations
- Spindles - Machine Finishing
- Spindles - Critical Finishing

To select a Machine Category:

1. Push **SETUP**.
2. Push **▼** and **▶** to highlight **Machine Category and RPM Range**.
3. Push **ENTER** to open the next menu.
4. Push **▼** and **▶** to highlight the category.
5. Push **ENTER** to set the category.

When the Machine Category is set, the Measurement screen shows the overall vibration, severity scale, and the Machine Category in the TYPE field.

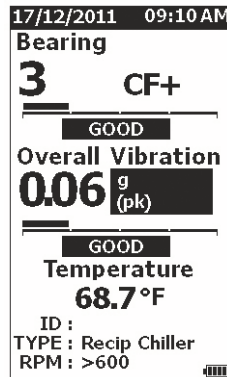

gqi80.jpg

Note

The Machine Category and RPM range must be set to view the Overall Vibration severity scale.

Create New Setup

A Setup is the group of test parameters you set for a machine. This set of parameters includes the Machine Category. You must set these parameters to enable the severity scale readout. You can save these parameters in Meter memory with a unique name, or machine ID. This is known as a First Level ID. In each First Level ID, you can set up multiple Second Level IDs that help to further organize the data measurements.

The advantages when you save to a setup are:

- easy recall of a Setup for frequent measurements
- save time when the parameter selection is preset and saved to memory
- view all measurements for a setup
- export measurements to a spreadsheet that tracks machine health (see *Export Data* on page 34 for more information)

To make a new setup:

1. Push **SETUP**.
2. Push **▼** and **▶** to highlight **Create NEW Setup**.
3. Push **ENTER** to open the Machine Categories menu.
4. Push **▼** and **▶** to highlight the Machine Category.

5. Push **ENTER** to set the category and open the RPM Range menu.

By default, the RPM range is set to >600 RPM and is correct for most applications. To change the RPM range: push **▼** and **▶** to highlight the **RPM Range**.

6. Push **ENTER** to set the range and open the Create Setups menu for the First Level ID.

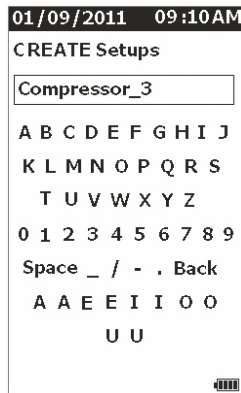

gqi94.jpg

7. Push **▼** **▶** and **◀** to highlight a letter or number.
8. Push **ENTER** to set the letter or number.
9. Repeat steps 8 and 9 to make a unique name for the setup.
10. Push **SAVE**.

The Meter prompts you to give the setup a Second Level ID. The Yes option opens the menu to key in a name for the ID.

11. Push **SAVE**.

You can continue this process and set up as many Second Level IDs as necessary for the job. For example, you can enter the bearing number that the measurement is taken from, such as, Bearing_1 on FAN1.

When done, select **No** to go back to the Setup menu. To recall a setup, see *View Setups* on page 29.

Add to Setup

You can add a Second Level ID to a setup in the Meter memory at any time.

To add a new Second Level ID:

1. Push **SETUP**.
2. Push **▼** and **▶** to highlight **Add to Setup**.
3. Push **▼** and **▶** to highlight the Setup name.
4. Push **ENTER** to open the menu for the Second Level ID.
5. Push **▼**, **▲**, **▶** and **◀** to highlight a letter or number.
6. Push **ENTER** to set the letter or number.
7. Repeat steps 5 and 6 to make a unique name for the setup.
8. Push **SAVE**.

After the Meter saves this new Second Level ID, it goes back to the Setup menu.

Enable Fluke Connect (805 FC only)

You can transmit the most recent measurement with wireless technology and view the results on the Fluke Connect App on your device.

Note

You need to enable Fluke Connect each time you turn on the Meter. When Fluke Connect is enabled, a wireless icon (📶) shows on the LCD.

To enable Fluke Connect:

1. Push **SETUP**.
2. Use the navigation buttons to select **Enable Fluke Connect**.

To disable Fluke Connect:

1. Push **SETUP**.
2. Use the navigation buttons to select **Disable Fluke Connect**.

To transmit a measurement to Fluke Connect:

1. Take a measurement.
2. Push **SAVE** to open the Save screen.
3. Select a method to save data.

When you save, the Meter transmits the data to Fluke Connect app.

4. Use the Fluke Connect App on your device to receive and view the test results.

How to Save a Measurement

As you make measurements with the Meter, you can save these measurements to memory. Quick measurements are saved as sequential files that start at 0001. You also can save a measurement to the current setup, an existing setup, or give it a unique name. The Meter saves to memory a maximum of 3,500 measurements.

Note

If the Meter exceeds the allowable memory, it automatically deletes old records on a first in, first out basis.

To save a measurement:

1. Take a measurement.
2. Push **SAVE** to open the Save screen.

Auto Save

The Auto Save option saves the measurement to memory with a sequential number that starts at 0001. Push **ENTER** to save the measurement. The Meter indicates the record number it is saving.

Save to Existing Setup

The Save to Existing Setup option saves the measurement to an Existing Setup.

To save the measurement to a setup:

1. Select **Save to: Existing Setup**.
2. Choose the option for how to sort the machine IDs or category.
 - **by Name**: shows a list of machine IDs in alphabetical order.
 - **by Category**: shows a list of machine categories in alphabetical sequence.
 - **Last Used**: shows the last machine ID measured.
3. Highlight the machine ID.
4. Push **SAVE**.

Save to Current Setup

This option saves the measurement to the current setup in the Meter. Push **SAVE** to save the measurement. The Meter indicates the record number it is saving.

Save to New Setup

This option saves the measurement to a new setup.

To save a measurement with a new Setup name:

1. Select **Save to: New Setup** in the Save screen.
2. Push **▼ ▲** to highlight **Machine Category**.
3. Push **ENTER** to select the option.
4. Push **▼ ▲** to highlight **RPM Range Selection**.
5. Push **ENTER** to select the option to open the Create Setup screen.
6. Select the numbers and letters to enter a new name. See *Create New Setup* for more information about how to use this screen.
7. Push **SAVE** to save the current measurement with a new name.

The Meter prompts you to give the setup a Second Level ID.

- Select **Yes** enter a name for the Second Level ID. and then push **SAVE**.
- Select **No** to save the setup.

You can continue this process and set up as many Second Level IDs as necessary for the job. When done, select **No** to go back to the Measurement Results menu.

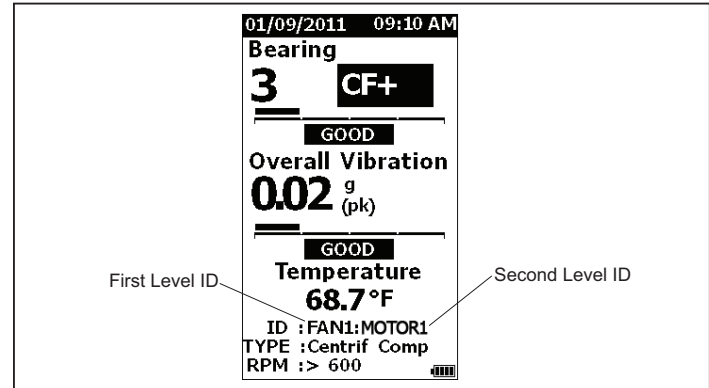

gqi19.eps

How to Recall a Setup for Measurements

You can recall a Setup file from memory for frequent measurements done on the same machine. A Setup file saves time when the parameter selection is already done and stored to memory.

To recall a Setup from memory:

1. Push **MEMORY** to open the MEMORY screen.
2. Push **▼** and **▲** to highlight **View Setups**.
3. Push **ENTER** to opens the VIEW SETUP screen with three sorting options:
 - **by Name:** shows a list of machine setups by machine ID in alphabetical sequence.
 - **by Category:** shows a list of machine setups by Machine Category in alphabetical sequence.
 - **Last Used:** shows the last used machine ID.
4. Push **▼** and **▲** to highlight an option.
5. Push **ENTER** to open the list of setups.
6. Push **▼** and **▲** to highlight a setup.
7. Push **ENTER** to open the setup record.
8. Push **MEASURE**.

Note

Push **MEASURE** before you apply the Meter to the test surface.

9. Push Meter onto test surface until the green LED turns on.
10. Wait until the green LED turns off.

The Measurement screen shows the selected Setup with machine ID in the ID field.

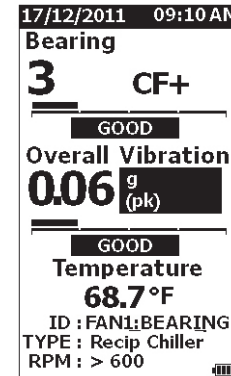

11. When measurement is complete, push **SAVE**.
12. Push **▼** and **▲** to highlight **Save To Current Setup**.
13. Push **ENTER** to save the measurement to the setup.

To recall a measurement, see *View All Data* on page 28.

gqi81.jpg

Access to Memory

The Memory screen contains a list of machine IDs and the saved data. You can make changes or delete the records from Meter memory with this screen.

Note

If the Meter exceeds the allowable memory, it automatically deletes old records on a first in, first out basis.

To access Meter memory:

1. Push **MEMORY** to open the MEMORY screen.
2. Push **▼** and **▲** to highlight an option from the MEMORY screen.

View All Data

The View ALL Data screen shows you all the measurements saved in the Meter.

To view saved measurements:

1. Push **▼** and **▲** to highlight **View ALL Data** in the Memory screen.
2. Push **ENTER** to see more options:
 - **by Name**: shows a list of measurements by machine ID in alphabetical sequence.
 - **by Category**: shows a list of measurements by Machine Categories in alphabetical sequence.
 - **Last Used**: Shows the last saved measurement.

3. Push **▼** and **▲** to highlight an option from the list.
4. Push **ENTER** to select option.
5. Push **▼** and **▲** to highlight a file.
6. Push **ENTER** to open the file.
7. Push **ENTER** to view the data.
8. Push **◀** and **▶** to select **Back** or **Delete** option.

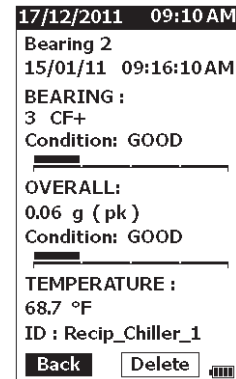

gqi99.bmp

The **Back** option opens the last screen. The **Delete** option removes the measurement from Meter memory.

View Setups

The View Setups option is how you can view a setup that is saved to memory.

To view or recall a Setup:

1. Push **MEMORY** to open the MEMORY screen.
2. Push **▼** and **▲** to highlight **View Setups** in the Memory screen.
3. Push **ENTER**. This opens the View Setups screen with three sorting options:
 - **by Name**: shows a list of machine setups by machine ID in alphabetical sequence.
 - **by Category**: shows a list of machine setups by Machine Category in alphabetical sequence.
 - **Last Used**: shows the last used machine setup.
4. Push **▼** and **▲** to highlight an option.
5. Push **ENTER** to open the list of setups.
6. Push **▼** and **▲** to highlight a setup.
7. Push **ENTER** to open the setup record.
8. Push **◀** and **▶** to select **Back** or **Delete** option.

The **Back** option opens the last screen. The **Delete** option removes the setup from Meter memory.

Edit Setups







Use this option to edit the Machine Setups that are saved in Meter memory. When any change is made to a Machine ID, all measurement data that is connected with the record is deleted.

To edit a Machine Setup:

1. Push **MEMORY** to open the MEMORY screen.
2. Push **▼** and **▲** to highlight **Edit Setups**.
3. Push **ENTER** to open the Sort Setups screen.

The Sort Setups screen is how to look up the saved Machine Setups:



- **by Name**: shows a list of Machine Setups by machine IDs in alphabetical sequence.
- **by Category**: shows a list of Machine Setups by the machine categories in alphabetical sequence.
- **Last used**: Shows the last used Machine Setup.

4. Push  and  to highlight an option.
5. Push **ENTER** to open the Existing Setups screen.
6. Push  and  to highlight the setup.
7. Push **ENTER** to open the EDIT SETUP screen for the ID, TYPE, and RPM.
8. Push  and  to highlight the ID line.
9. Push **ENTER** to open the Edit Setups screen for the ID.
10. Select the numbers and letters to change the machine ID of the setup. See *Create New Setup* for more information about how to use this screen.
11. Push **SAVE** to exit the alpha-numeric screen and pick another parameter to edit.

Clear All Data

The Clear ALL Data option lets you delete all the Machine Setups and measurements.

To clear memory:

1. Push **MEMORY**.
2. Push  and  to highlight **Clear ALL Data**.
3. Push **ENTER**.
4. To confirm deletion, push  to select **Yes**.
5. Push **ENTER** to delete all data.

Interpret Results





The Meter is a screening tool to identify machinery problems for more diagnostic tests. The Meter has a vibration severity scale for Bearing and Overall Vibration measurements. It can also trend vibration measurements over time. If a measurement shows high vibration severity, or if there is an adverse trend in vibration severity over time, then the machine can have a problem. Fluke recommends that you consult a vibration specialist for more tests to find the root cause of these problems.

Severity Scale

Measurements with a machine ID, machine category, and rotational speeds >600 RPM includes both severity scales. A good measurement always finds some vibration. There are four severity levels: good, satisfactory, unsatisfactory, and unacceptable. A measurement in the good category is an indication of a healthy machine.

Table 6 lists the different severity scales.

Table 6. Severity Scale

Scale	Action
	No repair action is recommended.
	No immediate repair action is required. Increase the frequency of measurements and monitor the condition of the machine.
	Have a knowledgeable vibration technician conduct more advanced tests at the earliest opportunity. Consider maintenance action at the next planned downtime or maintenance period.
	Have a knowledgeable vibration technician conduct more advanced tests as soon as possible. Consider immediate shutdown of the machine to make repairs and prevent failure.

ISO 10816 Standards

As an alternative to the Overall Vibration Severity Scale included in the Meter, you can use the ISO Standard 10816-1 to evaluate the severity of overall vibration levels. Table 7 is a chart that contains the values from this standard. You can compare the overall vibration value measured with the Meter to this table to identify the vibration severity.

Table 7. Vibration Severity - ISO 10816-1

Machine		Class I Small Machines	Class II Medium Machines	Class III Large Rigid Foundation	Class IV Large Soft Foundation
in/s	mm/s				
Vibration Velocity Vrms	0.01	0.28			
	0.02	0.45			
	0.03	0.71		GOOD	
	0.04	1.12			
	0.07	1.80			
	0.11	2.80		SATISFACTORY	
	0.18	4.50			
	0.28	7.10		UNSATISFACTORY	
	0.44	11.20			
	0.70	18.00			
	1.10	28.00		UNACCEPTABLE	
	1.77	45.9			

Trending

Trending, or repeated vibration measurements kept in a spreadsheet over time, is the best method to track machine health. See *Export Data* on page 34 for more information about the template and measurement plots.

The Excel template also can give an Overall Vibration Severity that refers to one of three ISO Standards:

- 10816-1
- 10816-3
- 10816-7

A brief description of each standard and terms is as follows:

ISO 10816-1

This standard contains general guidelines for machine vibration measurements on non-rotating parts.

Key terms

Class I: Individual parts of engines and machines integrally connected to the machine in normal operation. Production electrical motors at a maximum of 15 kW are examples of machines in this category.

Class II: Medium-sized machines (typically electrical motors with 15 kW to 75 kW output) without special foundations, rigidly mounted engines or machines (up to 300 kW) on special foundations.

Class III: Large prime-movers and other large machines with rotating masses mounted on rigid and heavy foundations that are relatively stiff in the direction of the vibration measurements.

Class IV: Large prime-movers and other large machines with rotating masses mounted on foundations that are relatively soft in the direction of vibration measurements (for example, turbo generator sets and gas turbines with outputs greater than 10 MW).

ISO 10816-3

This standard is used to evaluate machine vibration by measurements on non-rotating parts, for industrial machines with nominal power above 15 kW and nominal speeds between 120 RPM and 15,000 RPM when measured in situ.

Key terms

Rigid: A machine foundation with the machine supports rigidly attached to the machine skid and/or the solid floor of the facility.

Flexible: A machine with flexible attachment between the machine supports and foundation or facility floor. The most common example of this is a machine in which vibration isolators (flexible vibration damping mechanisms) separate the machine and foundation.

Group 1: Large machines with rated power above 300 kW and not more than 50 MW (electrical machines with shaft height: $H \geq 315$ mm).

Group 2: Medium-sized machines with rated power above 15 kW up to and including 300 kW, electrical machines with shaft height $160 \text{ mm} \leq H < 315$ mm.

ISO 10816-7

This standard is used to evaluate machine vibration on rotor dynamic pumps by measurements on nonrotating parts.

Note

The standard includes guidance for measurements on rotating shafts, but this portion is not applicable to the Meter.

Key terms

Category I: Pumps that require a high level of reliability, availability, or safety (for example, pumps for toxic and hazardous liquids, critical applications, oil and gas, special chemical, and nuclear or power plant application).

Category II: Pumps for general or less critical applications (for example, pumps for non-hazardous liquids).

Export Data

The export data feature lets you move data from the Meter to a PC through the USB connection. You can download a Microsoft Excel template from www.fluke.com. You can use the template to evaluate the measurements. The template includes fields for:

- Device ID (the Meter from which the data was downloaded)
- Machine ID (the machine on which the test was performed, machine ID may contain two levels)
- Machine Category (such as pump or compressor)
- High frequency/bearing measurement (Crest Factor+)
- Low frequency reading (overall vibration)
- Temperature
- Time and Date

To download the Trending template:

1. Turn on the computer (PC) and go to www.fluke.com.
2. Locate the Trending template and save a copy to your PC.

To export data and use the Trending template to plot a graph:

1. Make sure the Meter is off.
2. Connect the USB cable between the PC and the Meter. The Meter turns on and stays on when it is connected to the PC. See USB on page 16 for more information.
3. Open the template on the PC. See Figure 7.

The screenshot shows a software interface with a yellow header containing the 'FLUKE' logo. Below the header, there are two main sections. The first section, titled 'Import Database File', has a 'File Name' input field containing 'F:\MAIN_DB.TXT' and a 'Browse' button. The second section, titled 'Machine Configuration Details', contains four input fields: 'Device ID' (empty), 'Machine Category' (containing 'Direct Drive Fans'), 'Machine Name' (containing 'LOC1'), and 'Secondary Name' (containing 'LOC1'). At the bottom of this section are two buttons: 'Configure Graph' and 'View Data', followed by a blue arrow pointing to the right.

gqi203.jpg

Figure 7. Import Database

- Click **Browse** to find the MAIN_DB.TXT data file on the Meter.
- Click **Open**.

Note

The Trending template only reads data from files in TXT file format.

The file path shows in the File name field of the Trending template.

Note

Even though the template is password protected, you can copy and paste the raw data from View Data into a blank Excel spreadsheet.

- Click **Configure Graph** on the Trending template.

The **Graph Configuration Window** opens. See Figure 8.

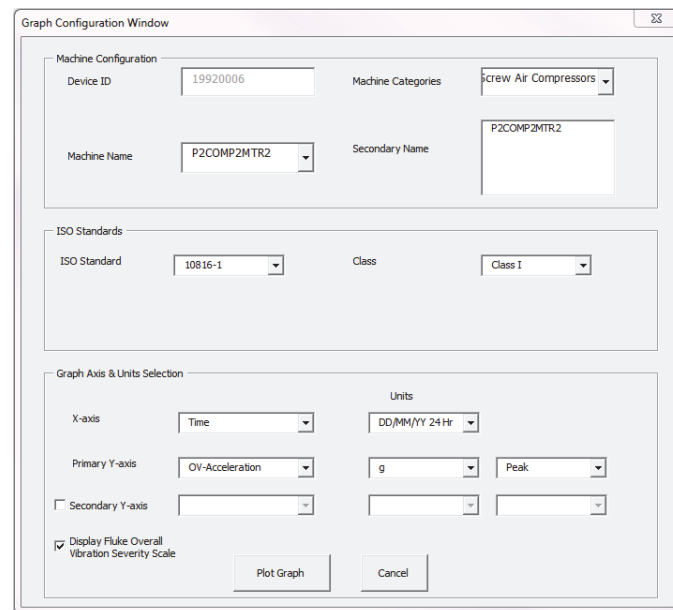

gqi205.bmp

Figure 8. Plot Options

7. Click each drop-down list to select the **Machine Configuration** from the saved measurement data:
 - **Machine Categories**
 - **Machine Name**
 - **Select Secondary Name**
8. Click the drop-down list for the ISO Standard and class.
9. Click each drop-down list to select the **Graph Axis & Unit Selection** for the plot:
 - X-axis required Parameters
 - X-axis required Units
 - Y-axis required Parameters
 - Y-axis required Units
 - Option for a secondary Y-axis (shows on the right side of the graph)
 - Option to show the Fluke Overall Vibration Severity Scale

10. Click **Plot Graph**.

Figure 9 is an example of a graph you can make with measurement data from the Meter.

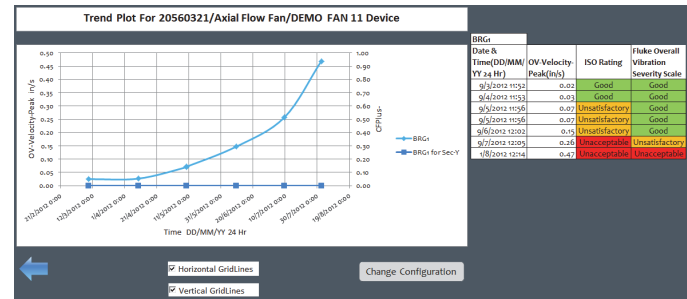

gqi206.bmp

Figure 9. Data Plot Graph

Note

*You can Print the results to a local printer, press **Ctrl + P** to open up the Print menu.*

General Maintenance

Maintenance is not necessary for the Meter.

⚠ Caution

**No part of the Meter is serviceable by the user.
Do not try to open the Meter.**

⚠ Caution

To prevent damage to the Meter or any performance loss, do not put the Meter in temperature extremes. The ambient operating temperature is -20 °C to 50 °C (-4 °F to 122 °F) with a humidity of 10-95% RH (non-condensing).

Care

Care should be taken to prevent scratches on the IR temperature sensor window.

⚠ Caution

To prevent damage to the IR temperature sensor and vibration sensor, do not hit, shake, or let the Meter fall. A damaged sensor decreases the diagnostic quality.

How to Clean

For the best accuracy of temperature measurements, clean the IR temperature sensor window with moist cloth before you take measurements. Clean the external case of the Meter at regular intervals with a moist cloth and a weak detergent solution.

⚠ Caution

To prevent damage or performance loss, keep the Meter dry. Do not put the Meter into any liquid. The Meter is not waterproof.

Battery Replacement

Note

Before the Meter operates for the first time, install the new batteries included with the shipment.

The Meter operates on two AA non-rechargeable lithium batteries.

To replace the batteries:

1. Loosen the two screws and remove the battery cover from the Meter, see Figure 10.
2. Align the batteries into the battery slot with the correct polarity.
3. Replace the battery cover and tighten the screws.

Note

Select the correct battery type in the Battery Selection menu. See page 12 for more information.

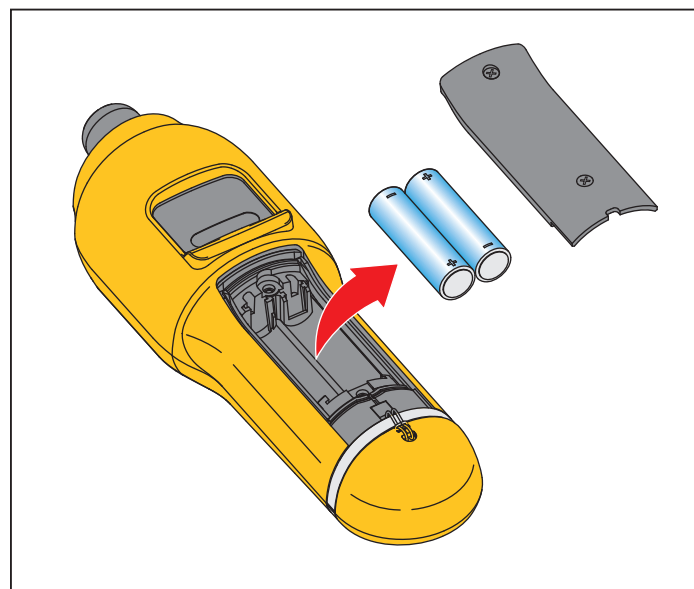

gqi02.eps

Figure 10. Battery Replacement

Firmware Upgrades

At intervals, upgrades are available for the Meter firmware. Contact Fluke for upgrade availability. If you have registered your Meter purchase, Fluke will send an upgrade notice to you automatically.

To upgrade the Meter:

1. Download the upgrade file for the Meter from the Fluke website at www.fluke.com.
2. Connect the USB cable to the PC or laptop. See USB on page 16 for more information.
3. Make sure the Meter is off.
4. Simultaneously push and hold **SETUP** and **▶** as you connect the other end of the USB cable to the Meter.

The Meter boots up in the firmware upgrade mode and stays on while it is connected to the PC.

5. Identify the external disk that is the Meter in an Explorer window on the computer.

6. Make a copy of the upgrade file to the external disk that is the Meter.
7. Right-click on the external disk and select eject.
8. Disconnect the Meter from the host PC.
9. Restart the Meter.

The Meter operates with the new firmware after the restart.

How to Troubleshoot

Table 8 is a list of problems, causes, and corrective actions for the Meter.

Table 8. Troubleshooting

Symptom	Cause	Corrective Action
Meter does not turn on.	<ul style="list-style-type: none"> The battery voltage is too low. The battery connection is loose. 	<ol style="list-style-type: none"> Replace the batteries. See <i>Battery Replacement</i> on page 38 for more information. Ensure the batteries are properly aligned and secured. If the problem continues, contact the Fluke Service Center ^[1] for technical support.
Buttons do not operate. Meter does not operate.		<ol style="list-style-type: none"> Restart the Meter. If the problem continues, contact the Fluke Service Center ^[1] for technical support.
The Meter cannot connect with the PC.	The USB cable is not connected correctly.	Correctly connect the USB cable. See <i>USB</i> on page 16 for more information.
	<ul style="list-style-type: none"> The USB cable is damaged. Check that USB drivers are installed in the PC/Laptop. 	<ol style="list-style-type: none"> Examine the USB cable for any damage. If you find damage, contact the Fluke Service Center ^[1] for a replacement cable. Reboot the PC.
PC does not see the Meter is connected.		Reboot the PC.
Error Message: Measurement invalid. Please hold to surface for full duration.	The Meter was not held on the surface for a sufficient time or with sufficient force.	Push Meter onto test surface until green LED turns on. Wait until the green LED turns off. See <i>About Measurements</i> on page 17 for more information.
[1] See <i>How to Contact Fluke</i> on page 1.		