

# Mini InfraRed (IR) Thermometer with Type K Input and Laser Pointer

## MODEL IR267

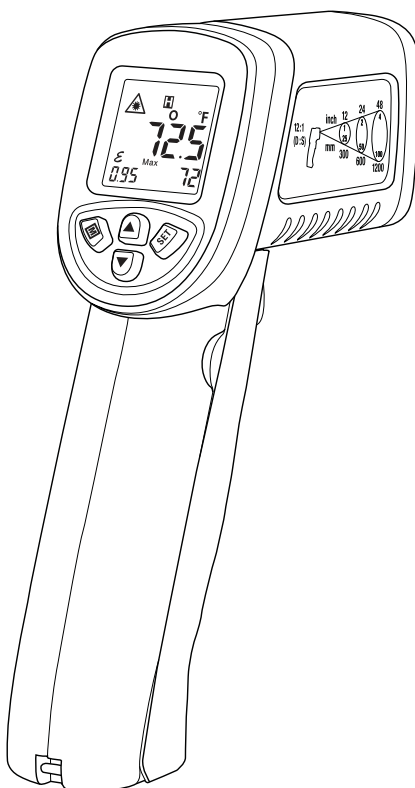

## ***Introduction***

---

Thank you for selecting the Extech Model IR267 Mini IR Thermometer.

The Model IR267 IR thermometer measures and displays non-contact (infrared) temperature readings and ambient air temperature. In addition, the Type K thermocouple provides contact temperature measurements.

The built-in laser pointer increases target accuracy while the backlit LCD and handy push-buttons combine for convenient, ergonomic operation. The adjustable emissivity feature allows the IR thermometer to measure the temperature of virtually any surface.

This device is shipped fully tested and calibrated and, with proper use, will provide years of reliable service.

**Please visit our website ([www.extech.com](http://www.extech.com)) for the latest version of this User Guide, Product Updates, Product Registration, Customer Support, and User Manual Translations.**

## ***Features***

---

- Measures non-contact surface temperature up to 1112°F (600°C)
- Measures ambient air temperature to 158°F (70°C)
- Type-K thermocouple input offers contact temperature measurements
- 12:1 Distance to Spot Ratio (Field of View)
- Single-point laser targeting
- Automatic Data Hold when trigger is released
- Display Backlight
- MAX/MIN/AVG/DIF temperature recording function
- Selectable temperature units (°F / °C)
- Battery status indication
- Adjustable emissivity
- Visible alarm indication for High and Low Temperature Alarm
- Auto power off approximately 10 seconds after trigger release

# Safety

---

## International Safety Symbols



This symbol, adjacent to another symbol or terminal, indicates the user must refer to the manual for further information

## Warnings

- Do not directly or indirectly point the laser at the eyes of a person or an animal
- Inspect for damage or for any shortage of parts or accessories before use
- Replace the battery immediately after the battery indicator flashes
- Do not connect an external probe to live electrical circuits
- Do not submerge in water
- Do not leave the thermometer on or near objects of high temperature
- Do not use the thermometer near explosive gases, steam, or dust
- Note that an object with high reflectivity will normally cause the measured temperature value to read much lower than the actual temperature
- Use the device only as described in this User Guide

## Cautions

To avoid thermometer damage, please avoid the following hazards:

- EMF from welding equipment or electro-induction heaters
- Static electricity
- Thermal shock caused by large or abrupt environmental temperature changes; wait 30 minutes to allow the thermometer to stabilize to new environmental conditions
- Do not use this device in excessively high temperature environments
- If the meter is to be stored for a long period of time the battery should be removed to prevent damage to the unit



# Description

## Meter Description

1. LCD Display
2. Control Buttons
3. Lanyard
4. Type-K Thermocouple input jacks
5. Battery compartment (9V)
6. Measurement Trigger
7. IR Thermometer lens
8. Ambient temperature sensor
9. Laser pointer lens

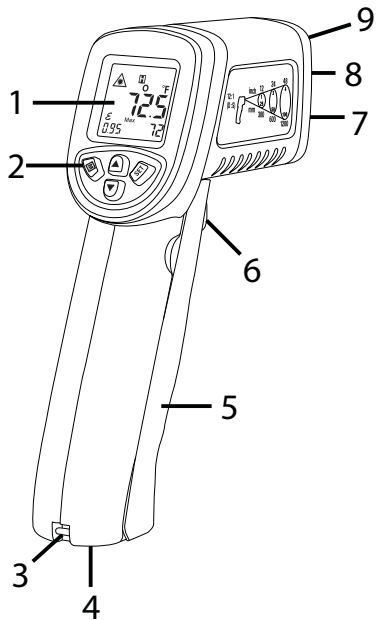

## Display Description

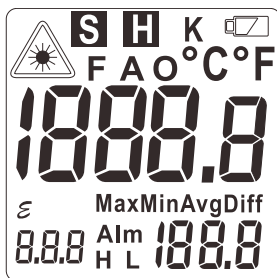

	Large digits at center for primary measurement value
	Small digits at lower right for MAX-MIN-AVG-DIF values
	Small digits at lower left for Emissivity value
	Emissivity value indication
	Laser pointer active
	Scan mode (active while the trigger is pulled; displayed temperature tracks the temperature of the scanned surfaces)
	Hold mode (displayed temperature freezes with trigger release)
<b>Max Min Avg Diff</b>	Maximum/Minimum/Average/Differential temperature readings
	Battery capacity indicator (flashes when battery voltage is critical)
<b>K A O</b>	K/A/O Temperature measurement types: K: Thermocouple, A: Ambient, O: Object/Surface
<b>°F °C</b>	Temperature units (°F / °C)
<b>Alm H L</b>	High and Low Temperature Alarms

# Operation



---

## Meter Power

The meter is powered by one 9V battery located in the meter handle. Refer to the Maintenance section for replacement instructions. The displayed battery icon provides battery status. Replace the battery as soon as the battery status icon flashes.

## Non-Contact IR Surface Temperature Measurements

The IR267 thermometer remotely measures the surface temperature of an object. The emissivity must be properly set to obtain optimum accuracy (see the Emissivity section for details).

1. Hold the meter by the handle grip and pull (and hold) the trigger to power the meter. Use the arrow button to select the **O** (object/surface) mode if necessary. Scan the surfaces under test; the symbol  (scan) blinks while scanning. Refer to the Field of View section for distance-to-target (spot) ratio considerations.
2. Aim the laser pointer approximately a half inch below a specific point of interest.
3. Release the Trigger; the symbol  will appear and the reading (larger digits at center of display) will hold for 10 seconds, after which the meter will automatically shut off.
4. Note that the smaller digits, lower right, reflect the MIN-MAX-AVG or DIF reading as selected in the Settings mode.
5. The meter defaults to the settings in use when the meter was last switched OFF.

## Ambient (Air) Temperature Measurements

The IR267 can measure the temperature of ambient air using the recessed temperature sensor located on the front of the meter next to the laser pointer lens.

1. Pull and hold the Trigger to keep the meter powered.
2. Use the UP or DOWN button to select the **A** (ambient) mode.
3. Hold the meter by its handle grip in the ambient air.
4. When finished, release the Trigger; the symbol  will appear and the ambient air temperature reading will hold for 10 seconds.

## Contact Thermocouple (Type-K) Temperature Measurements



To avoid electrical shock or personal injury, do not connect the external probe to live electrical circuits.

1. Plug the Type-K thermocouple sensor into the sub-miniature jacks at the bottom of the instrument (one plug spade is wider than the other).
2. Pull the trigger to power the meter. Hold the trigger to keep the meter powered.
3. Use the arrow buttons to select the **K** (thermocouple) mode.
4. Hold the thermocouple in air or touch the tip of the thermocouple to an object's surface. The thermocouple temperature measurement will be displayed.
5. When finished, release the Trigger; the symbol  will appear and the thermocouple temperature reading will hold for 10 seconds.

## Over-range Indicators (OL and -OL)

If the temperature measurement exceeds 1112°F (600°C), the thermometer will display **OL** in place of a temperature reading. If the temperature measurement is below -58°F (-50°C), the thermometer will display **-OL** in place of a temperature reading.

## Locating Hot or Cold Spots

To detect a hot or cold spot, aim the thermometer at a region beyond the target and then scan the entire region in a slow, up/down motion. Aim the laser pointer approximately a half inch below the point of test.

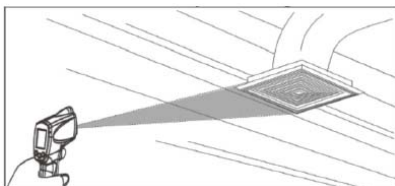

## Distance to Spot Ratio (Field of View)

The meter's field of view is 12:1 (distance to spot ratio). For example, if the meter is 24 inches from the target (spot), the diameter of the target must be at least 2 inches. Other distances are shown below in the field of view diagram.

Note that measurements should normally be made < 2 feet from the target. The meter can measure from further distances but the measurement may be affected by external sources of light. In addition, the spot size may be so large that it encompasses surface areas not intended to be measured.

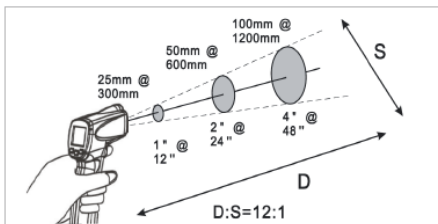

It is necessary to ensure that the size of the target is larger than the spot size. The smaller the target, the closer the distance should be. See the accompanying diagram.

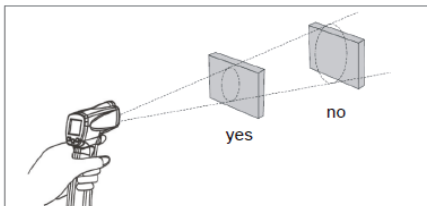

## Emissivity

The Emissivity setting is shown in small digits at the lower left corner of the display. To adjust the Emissivity please refer to the Settings mode section.

Emissivity represents the reflectivity of a material. Most organic materials and painted or oxidized surfaces have an emissivity of approximately 0.95. If possible, masking tape or flat black paint should be applied to cover the measured surface.

Wait a period of time to allow the tape or paint to reach thermal equilibrium with the surface of the covered object. Measure the temperature of the surface covered with tape or paint only after equilibrium has been achieved.

Another way to find the emissivity of a surface is to use the Type-K thermocouple to take a contact temperature reading. Note this reading and then take a non-contact temperature reading and adjust the emissivity until the non-contact measurement matches the contact measurement.

### Emissivity Factors for Common Materials

Material under test	Emissivity	Material under test	Emissivity
Asphalt	0.90 to 0.98	Cloth (black)	0.98
Concrete	0.94	Skin (human)	0.98
Cement	0.96	Leather	0.75 to 0.80
Sand	0.90	Charcoal (powder)	0.96
Soil	0.92 to 0.96	Lacquer	0.80 to 0.95
Water	0.92 to 0.96	Lacquer (matt)	0.97
Ice	0.96 to 0.98	Rubber (black)	0.94
Snow	0.83	Plastic	0.85 to 0.95
Glass	0.90 to 0.95	Timber	0.90
Ceramic	0.90 to 0.94	Paper	0.70 to 0.94
Marble	0.94	Chromium Oxides	0.81
Plaster	0.80 to 0.90	Copper Oxides	0.78
Mortar	0.89 to 0.91	Iron Oxides	0.78 to 0.82
Brick	0.93 to 0.96	Textiles	0.90

## High and Low Temperature Alarms

The IR267 has a low alarm and a high alarm utility. Set the low and high alarm limits in the Settings mode. See the Settings mode section for details. The low and/or the high alarms can also be disabled in the Settings mode. When the low or high alarm limits are reached the **L** (low alarm) or **H** (high alarm) icon will blink and the alarm buzzer will sound (the buzzer can be disabled in the Settings mode).

# Settings Mode

---

Press and release the trigger and then press the **M** (Mode) button to access the Settings Mode. Use the **M** button to step through settings listed below and use the **SET** button to make changes.

- Display mode: Maximum reading (**MAX**), Minimum reading (**MIN**), Average reading (**AVG**), Differential reading (**DIFF**)
- Backlight ON/OFF (**LitE**)
- Laser pointer (**LAS**) ON/OFF setting
- High Temperature Alarm Limit setting (**ALM H**)
- Low Temperature Alarm Limit setting (**ALM L**)
- Emissivity ( $\epsilon$ ) setting
- Temperature unit selection ( $^{\circ}\text{C}/^{\circ}\text{F}$ )
- Buzzer ON/OFF (**bU2**)

To exit the Settings Mode, press the trigger to return to normal operating mode or simply allow the automatic power OFF feature to switch the meter OFF.

## Display Mode: MAX-MIN-AVG-DIFF

Press the trigger and release. Use **M** Button to step through MAX-MIN-AVG-DIF display mode icons. Press **SET** when the desired icon is shown. Pull the trigger to return to the normal operating mode. The display (smaller digits lower right) will reflect the selected mode.

## Backlight – ON/OFF

Press the trigger and release. Use the **M** button to step to the **LitE** display. Press the **SET** button to select **oN** or **oFF**. Pull the trigger to return to the normal operating mode.

## Laser – ON/OFF

Pull the trigger and release. Use the **M** button to step to the **LAS** display. Use the **SET** button to select **oN** or **oFF**. Pull the trigger to return to the normal operating mode. When the laser is ON, the laser icon  will appear on the LCD.

## HIGH Temperature Alarm Limit Setting

Pull the trigger and release. Use the **M** button to step to **Alm H**. Use the arrow buttons to set the High Alarm limit. Press the **SET** button to turn the High Alarm OFF. Pull the trigger to return to the normal operating mode. If the high alarm limit is exceeded when taking measurements, the displayed **ALM H** will blink and the alarm buzzer will sound (if '**bU2**' is set to ON).

## LOW Temperature Alarm Limit Setting

Pull the trigger and release. Use the **M** button to step to **Alm L**. Use the arrow buttons to set the Low Alarm limit. Press the **SET** button to turn the Low Alarm OFF. Pull the trigger to return to the normal operating mode. If the low alarm limit is exceeded when taking measurements, the displayed **ALM L** will blink.

## Emissivity Setting

Pull the trigger and release. Use the **M** button to step to the  $\epsilon$  icon. Use the arrow buttons to adjust the emissivity (in 0.01 steps). The emissivity range is 0.05 to 1.00. Pull the trigger to return to the normal operating mode. For more information, see the Emissivity section.



### Selecting the Temperature Unit of Measure (°C/°F)

Pull the trigger and release. Use the **M** button to step to °C/°F. Use the **SET** button to select °C or °F. Pull the trigger to return to the normal operating mode **and the alarm buzzer will sound (if 'bU2' is set to ON)**.

### Setting the Alarm Buzzer 'bU2' ON/OFF

Pull the trigger and release. Use the **M** button to step to 'bU2'. Use the **SET** button to select **ON** or **OFF**. Pull the trigger to return to the normal operating mode. When set to OFF, the Alarm buzzer will not sound in an alarm condition.

## Measurement Notes

---

1. The object under test should be larger than the spot (target) size calculated using the field of view diagram.
2. If the surface of the object under test is covered with frost, oil, grime, etc., clean before taking measurements.
3. If an object's surface is highly reflective apply masking tape or flat black paint to the surface before measuring.
4. The meter cannot make accurate measurements through transparent surfaces such as glass.
5. Steam, dust, smoke, etc. can obscure measurements.
6. The meter compensates for deviations in ambient temperature. It can, however, take up to 30 minutes for the meter to adjust to extremely wide ambient temperature changes.
7. To find a hot spot, aim the meter outside the area of interest then scan across (in an up and down motion) until the hot spot is located.

## Maintenance

---

### Cleaning

To clean the lenses, use compressed air to clear dust and other particles, then carefully clean with a wet cotton swab. The cotton swab should be moistened with clean water.

To clean the meter housing, wipe with a damp, soft cloth. Do not use solvents or abrasives. Do not immerse the IR267 in water or other liquid.

### Troubleshooting

Symptom	Problem	Action
OL display	Target temperature exceeds range	Select a target within range
-OL display	Target temperature under-range	Select a target within range
Battery icon flashes	Low Battery power	Replace Battery
Blank display screen	Low battery power	Check and/or replace battery
Incorrect/No displayed value	Wrong measurement function selected	Press Up/Down arrow to select correct measurement function
No Laser pointer	Low battery	Ensure that the Laser (LAS) is set to ON in the Settings mode Replace the battery
Display freezes/undefined reading	Locked display	Turn the meter OFF then pull trigger again after 3 seconds

## Battery Replacement

When the battery icon flashes, or when the meter doesn't switch ON, replace the battery:

- The battery compartment is located in the hand grip.
- The battery compartment lid is located just below the trigger.
- Open the battery door by prying with a thumb or finger at one of the indentations near the top of the hand grip.
- The door is hinged at the bottom of the hand grip.
- The battery should be installed with the positive + terminal (smaller contact) facing the meter to ensure correct polarity.

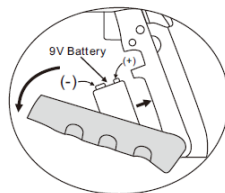

**Safety:** Please dispose of batteries responsibly; never dispose in a fire, batteries may explode or leak. If the meter is not to be used for 60 days or more, remove the battery and store separately.

## Specifications

### Temperature Specifications

Temperature Mode	Object (Surface Mode)	Ambient (Air)	Thermocouple (Type K)
Range	-58 ~ 1112°F (-50 ~ 600°C)	-4 ~ 158°F (-20 ~ 70°C)	-58 ~ 1832°F (-50 ~ 1000°C)*
Accuracy	± 4.1°F (5°C) from -58 ~ 5°F (-50°C ~ -15°C)		
	± 3.9°F (4°C) from 5 ~ 32°F (-15°C ~ 0°C)		
	± 3.6°F (2°C) from 32 ~ 212°F (0°C ~ 100°C)		
	± 3%rdg + 1°C from 212 ~ 1112°F (100°C ~ 600°C)		
	Accuracy is specified for the following ambient temperature range: 73 ~ 77°F (23 ~ 25°C)		
Resolution	0.1 °F/°C		
Emissivity	0.05 ~ 1.00 adjustable		
Field of View	D/S = Approx. 12:1 ratio (D = distance; S = spot or target)		
Laser pointer	Class 2 laser < 1mW power; Wavelength is 630 ~ 670nm		
IR Spectral response	8 ~ 14 μm (wavelength)		

\* The supplied thermocouple is rated for 482°F (250°C) **maximum** temperature. To measure higher temperatures, please obtain a Type-K thermocouple rated for the desired temperature.

### General Specifications

Display	Backlit multifunction LCD display
Display update rate	< 1 second approx.
Operating Temperature	32°F ~ 122°F (0°C ~ 50°C)
Operating Humidity	10 ~ 80% Relative Humidity max.
Storage Temperature	-14 ~ 140°F (-10°C ~ 60°C)
Power Supply	One 9V battery
Automatic Power Off	Meter shuts off automatically after 10 seconds
Weight	4.88 oz. / 138g
Dimensions	6.0 x 4.7 x 1.7" (153 x 120 x 42mm)

## **Warranty**

---

*FLIR Systems, Inc. warrants this Extech Instruments brand device to be free of defects in parts and workmanship for one year from date of shipment (a six month limited warranty applies to sensors and cables). If it should become necessary to return the instrument for service during or beyond the warranty period, contact the Customer Service Department for authorization. Visit the website [www.extech.com](http://www.extech.com) for contact information. A Return Authorization (RA) number must be issued before any product is returned. The sender is responsible for shipping charges, freight, insurance and proper packaging to prevent damage in transit. This warranty does not apply to defects resulting from action of the user such as misuse, improper wiring, operation outside of specification, improper maintenance or repair, or unauthorized modification. FLIR Systems, Inc. specifically disclaims any implied warranties or merchantability or fitness for a specific purpose and will not be liable for any direct, indirect, incidental or consequential damages. FLIR's total liability is limited to repair or replacement of the product. The warranty set forth above is inclusive and no other warranty, whether written or oral, is expressed or implied.*

## **Calibration, Repair, and Customer Care Services**

---

FLIR Systems, Inc. offers repair and calibration services for the Extech Instruments products we sell. We offer NIST traceable calibration for most of our products. Contact our Customer Service Department for information on calibration service availability. Annual calibrations should be performed to verify meter performance and accuracy. Technical support and general customer service is also provided, refer to the contact information provided below.

**Support Lines: U.S. (877) 239-8324; International: +1 (603) 324-7800**

Technical Support: Option 3; E-mail: [support@extech.com](mailto:support@extech.com)

Repair & Returns: Option 4; E-mail: [repair@extech.com](mailto:repair@extech.com)

Product specifications are subject to change without notice

**Please visit our website for the most up-to-date information**

**[www.extech.com](http://www.extech.com)**

FLIR Commercial Systems, Inc., 9 Townsend West, Nashua, NH 03063 USA

**ISO 9001 Certified**

**Copyright © 2016-2017 FLIR Systems, Inc.**

All rights reserved including the right of reproduction in whole or in part in any form

**[www.extech.com](http://www.extech.com)**

## Garantie

---

*FLIR Systems, Inc. garantit que cet appareil Extech Instruments est exempt de défauts matériaux et de fabrication pendant un an à partir de la date d'envoi (une garantie limitée de six mois s'applique aux capteurs et aux câbles). Si le renvoi de l'appareil pour réparation devient nécessaire durant ou après la période de garantie, contactez le service client pour autorisation. Pour obtenir les coordonnées, visitez le site Web suivant : [www.extech.com](http://www.extech.com). Un numéro d'autorisation de retour (AR) doit être délivré avant tout retour de produit. L'expéditeur prend à sa charge les frais d'expédition, le fret, l'assurance et l'emballage correct de l'appareil afin de prévenir toute détérioration durant le transport. Cette garantie ne s'applique pas aux dommages imputables à l'utilisateur, tels que l'usage impropre ou abusif, un mauvais câblage, une utilisation non conforme aux spécifications, un entretien ou une réparation incorrecte, ou toute modification non autorisée. FLIR Systems, Inc. déclinera spécifiquement toute garantie ou qualité marchande ou aptitude à l'emploi prévu, et ne sera en aucun cas tenu responsable pour tout dommage consécutif, direct, indirect ou accidentel. La responsabilité totale de FLIR est limitée à la réparation ou au remplacement du produit. La garantie définie ci-dessus est inclusive et aucune autre garantie, écrite ou orale, n'est exprimée ou implicite.*

## Calibrage, réparation et services après-vente

---

FLIR Systems, Inc. offre des services de calibrage et de réparation pour les produits Extech Instruments que nous commercialisons. Nous offrons l'étalonnage traçable NIST pour la plupart de nos produits. Contactez notre service clientèle pour obtenir des informations sur la disponibilité des services d'étalonnage. Un calibrage doit être effectué chaque année pour vérifier les performances et la précision du mètre. Nous offrons également une assistance technique et un service à la clientèle. Veuillez vous reporter aux coordonnées fournies ci-dessous.

**Lignes d'assistance: États-Unis (877) 239-8324; international: +1 (603) 324-7800**

Service d'assistance technique : Option 3 ; E-mail : [support@extech.com](mailto:support@extech.com)

Réparations et retours : Option 4 ; E-mail : [repair@extech.com](mailto:repair@extech.com)

Les spécifications produit sont sujettes à modifications sans préavis.

**Pour les toutes dernières informations, veuillez visiter notre site Web.**

**[www.extech.com](http://www.extech.com)**

FLIR Commercial Systems, Inc., 9 Townsend West, Nashua, NH 03063 USA

**Certifié ISO 9001**

**Copyright © 2016-2017 FLIR Systems, Inc.**

Tous droits réservés, y compris la reproduction partielle ou totale sous quelque forme que ce soit.

**[www.extech.com](http://www.extech.com)**

## Garantía

---

*FLIR Systems, Inc., garantiza este dispositivo marca Extech Instruments para estar libre de defectos en partes o mano de obra durante un año a partir de la fecha de embarque (se aplica una garantía limitada de seis meses para cables y sensores). Si fuera necesario regresar el instrumento para servicio durante o después del período de garantía, llame al Departamento de Servicio al Cliente para obtener autorización. Visite [www.extech.com](http://www.extech.com) para Información de contacto. Se debe expedir un número de Autorización de Devolución (AD) antes de regresar cualquier producto. El remitente es responsable de los gastos de embarque, flete, seguro y empaque apropiado para prevenir daños en tránsito. Esta garantía no se aplica a defectos resultantes de las acciones del usuario como el mal uso, alambrado equivocado, operación fuera de las especificaciones, mantenimiento o reparación inadecuada o modificación no autorizada. FLIR Systems, Inc., rechaza específicamente cualesquier garantías implícitas o factibilidad de comercialización o idoneidad para cualquier propósito determinado y no será responsable por cualesquier daños directos, indirectos, incidentales o consecuentes. La responsabilidad total de FLIR está limitada a la reparación o reemplazo del producto. La garantía precedente es inclusiva y no hay otra garantía ya sea escrita u oral, expresa o implícita.*

## Servicios de calibración, reparación y atención a clientes

---

**FLIR Systems, Inc., ofrece servicios de reparación y calibración** para los productos que vendemos de Extech Instruments. Ofrecemos calibración rastreada a NIST para la mayoría de nuestros productos, para información sobre la disponibilidad del servicio de calibración por favor llame a nuestro Departamento de Servicio al Cliente.

Para verificar el funcionamiento y precisión se debe realizar la calibración anual. Además se provee Soporte Técnico y servicios generales al cliente, consulte la información de contacto en seguida.

**Líneas de soporte: EE.UU. (877) 239-8324; Internacional: +1 (603) 324-7800**

Soporte Técnico Opción 3; correo electrónico: [support@extech.com](mailto:support@extech.com)

Reparación / Devoluciones: Opción 4; correo electrónico: [repair@extech.com](mailto:repair@extech.com)

Las especificaciones del producto están sujetas a cambios sin aviso

**Por favor visite nuestra página en Internet para la información más actualizada**

**[www.extech.com](http://www.extech.com)**

FLIR Commercial Systems, Inc., 9 Townsend West, Nashua, NH 03063 USA

***Certificado ISO 9001***

**Copyright © 2016-2017 FLIR Systems, Inc.**

Reservados todos los derechos, incluyendo el derecho de reproducción total o parcial en cualquier medio

**[www.extech.com](http://www.extech.com)**