Digital Microhmmeter Type D07 PLUS

Operating Instructions



Bracken Hill, South West Industrial Estate,
Peterlee, Co. Durham SR8 2SW. England.
Tel: +44 (0)191-586 3511 Fax: +44 (0)191-586 0227
www.cropico.co.uk
sales@cropico.co.uk

Limited Warranty & Limitation of Liability

CROPICO guarantees this product for a period of 1 year. The period of warranty will be effective at the day of delivery.

(c) Copyright 2009

All rights reserved. Nothing from this edition may be multiplied, or made public in any form or manner, either electronically, mechanically, by photocopying, recording, or in any manner, without prior written consent from CROPICO. This also applies to accompanying drawings and diagrams.

Due to a policy of continuous development CROPICO reserves the right to alter the equipment specification and description outlined in this publication without prior notice and no part of this publication shall be deemed to be part of any contract for the equipment unless specifically referred to as an inclusion within such contract.

Disposal of Old Product



This product has been designed and manufactured with high quality materials and components that can be recycled and reused.

When the crossed out wheellie bin symbol is attached to a product it means the product is covered by the European Directive 2002/96/EC.

Please familiarise yourself with the appropriate local separate collection system for electrical and electronic products.

Please dispose of this product according to local regulations. Do not dispose of this product along with normal waste material. The correct disposal of this product will help prevent potential negative consequences for the environment and human health.

User Note:

These Operating Instructions are intended for the use of Competent Personnel.

Section 1 – Instrument set-up and operation

Table of Contents

	Page No.
1. Introduction	4
1.1 Overview	5
1.2 Standard Features of the DO7PLUS	5
1.3 Definitions and Terminology	6
1.4 Specification	6
1.4.1 Measurement Accuracy	6
1.4.2 Temperature Compensation accuracy	6
1.4.3 Conditions of Use	6
1.4.4 Lead Resistance	6
1.4.5 DC Power Input	6
1.4.6 External Mains Power Unit	6
1.4.7 Battery Operation	6
1.4.8 Weight and Size	7
2. About the DO7PLUS	8
2.1 Safety Information	8
2.2 Unpacking the Instrument	9
2.3 Cleaning Instructions	9
2.4 Battery Pack Replacement	9
2.5 The Front Panel	10
3. Getting Started	12
3.1 Battery charger	12
3.2 About the Display Screen	12
4. Instrument Set-Up	14
4.1 Setting the DO7PLUS instrument configuration	14
4.2 Instrument SET UP table	15
4.3 Setting the DO7PLUS measurement configuration	16
4.4 Measurement configuration table	16
4.5 Setting the Range	18
4.6 Setting the measurement current	19
4.7 Zero Mode	20
4.8 Short cut keys	20
4.9 Menu options explained	20
4.9.1 Range	20
4.9.2 Current	20
4.9.3 Trigger	21
4.9.4 Limits	22
4.9.5 Data Log	23
4.9.6 Statistics	24
4.9.7 Graphics	25
4.9.8 Cooling Curve	26
4.9.9 Temperature Compensation	27
4.9.10 Filter	28
4.9.11 Settling	29
4.9.12 Cable Mode	30
4.9.13 Memories	30
5. Measuring with the DO7PLUS	32
5.1 Connecting to the DO7PLUS	32
5.2 Connecting to the resistance	32
5.3 Resistance Measurement	34
5.4 Measurement with temperature Compensation	34
5.5 Effects of lead resistance	34
6. Calibration	35
7. Firmware Update	37
8. RS232 Connection Diagram	37
9. Accessories	38

1 INTRODUCTION

1.1 OVERVIEW

The DO7PLUS Microhmmeter is a high accuracy instrument designed for industrial and laboratory resistance measurements. Its rugged case and robust construction ensures that accurate and reliable measurements are delivered even under the harshest of environments.

The DO7PLUS is a true four wire measuring instrument eliminating the need to compensate for lead resistance. The measured value is displayed in large characters with decimal point and units k Ω , Ω , or m Ω . For maximum accuracy the measuring current may be automatically reversed and the average of measurement displayed. For measurements on unstable samples, a rolling average filter is available.

Resistance measurement accuracy is typically 0.05% (1 year specification) and the value may be displayed with or without temperature compensation.

The front panel measurement connections are made via 4mm sockets located on the front panel. The connection to a Pt100 temperature sensor is made with a Micro Buccaneer 400 series connector. For remote control both USB and RS232 interfaces are available which will also enable the instrument firmware to be updated from a PC.

The included data-log function has the ability to display logged values in a table or graphical format and notes may be added to each logged value. The DO7PLUS also has the facility to automatically measure and calculate cooling curves displaying in both graphical and numeric formats. This makes the DO7PLUS the ideal instrument for machine testing. Hi/Lo limits are a standard feature

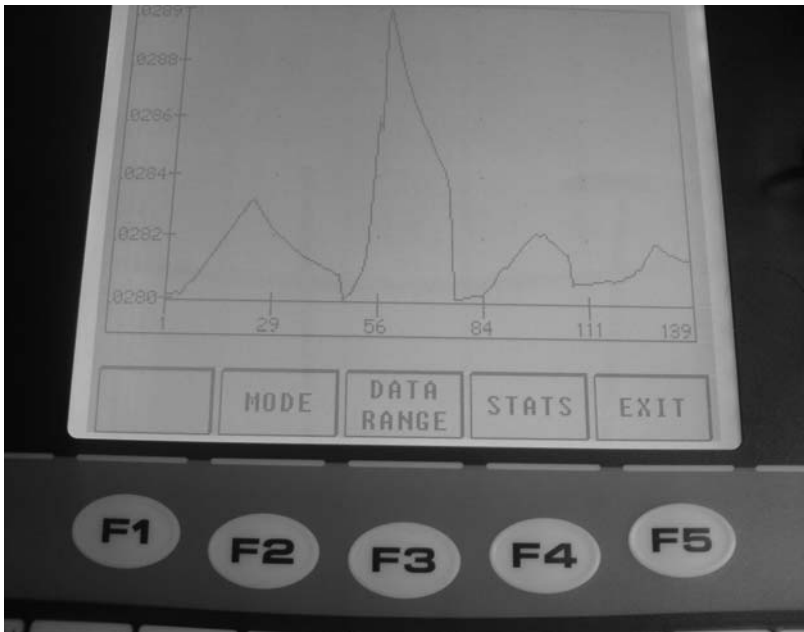

1.2 Standard features of the DO7PLUS Microhmmeter include:

- Graphical and Numerical display of electrical machine cooling curves
- Automatic temperature compensation
- Fast reading rate 2 measurements per second
- Measuring ranges from 6 mOhm to 6 kOhm
- Resolution 100 nOhm on 6mOhm range
- Up to 10 Amp measuring current
- Continuous measurement for inductive samples, single pulse measurement for fast resistance tests
- Full test lead continuity testing
- Hi/Lo Limits with Red/Green front panel warning LEDs
- Switched current mode with automatic averaging ensures elimination of thermal emf errors
- Multi lingual graphic LCD display for resistance measurement values as well as configuration settings and statistical results.
- Advanced functions include data logging and statistical reporting with max/min, average values, peak to peak value, and standard deviation. Full QWERTY keyboard for adding notes to logged measurements
- RS232 and USB interfaces available for automated monitoring and controlling applications
- Graphical display of logged values
- Full range of measurement accessories

1.3 Definitions and Terminology

nΩ nano Ohm	0.00000001 Ohm
μΩ micrOhm	0.000001 Ohm
mΩ milliOhm	0.001 Ohm
kΩ kilOhm	1000 Ohm
Pt100	Platinum resistance sensor (100Ω at 0°C)
+U/-U	Voltage connection
+I/-I	Current connection
Four terminal measurement	Kelvin principle of measurement using 2 wires (+I and -I) to pass current through Rx and 2 wires (+U and -U) to measure the voltage.
Kelvin clips	Crocodile clips with isolated jaws, one side being the current I connection, the other voltage U connection.
km	Indicates cable length in Kilometres
m	Indicates cable length in metres
Cooling Curve	A method of determining the maximum temperature of an electrical machine when running at full load

1.4 Specification



Prior to connecting this instrument always ensure that the circuit under test is electrically isolated. Connecting this instrument to circuits which have not been isolated could lead to a hazard.

1.4.1 Measurement accuracy

Range	Measuring Current	Resolution	FSV	Accuracy at full rated current
6.0000mΩ	10A	100nΩ	60mV	$\pm(0.05\%Rdg+0.01\%FS)$
60.000mΩ	1 A	1μΩ	60mV	$\pm(0.05\%Rdg+0.01\%FS)$
600.00mΩ	100mA	10μΩ	60mV	$\pm(0.05\%Rdg+0.01\%FS)$
6.0000Ω	10mA	100μΩ	60mV	$\pm(0.05\%Rdg+0.01\%FS)$
60.000Ω	1mA	1mΩ	60mV	$\pm(0.05\%Rdg+0.01\%FS)$
600.00Ω	100μA	10mΩ	60mV	$\pm(0.05\%Rdg+0.01\%FS)$
6.0000kΩ	100μA	100mΩ	600mV	$\pm(0.05\%Rdg+0.01\%FS)$

1.4.2 Temperature compensation accuracy

The accuracy of the temperature measurement is $\pm 0.1\%$ and uses a standard Pt100 sensor (EN60751). This accuracy does not include errors due to the sensor itself. The temperature measurement range is 0...+100°C and the default resistance measurement is referenced to 20°C when this option is used. Other reference temperatures may be selected by the user over the range 0°C to +50°C

1.4.3 Conditions of use

The DO7PLUS is suitable for indoor and outdoor operation.

Maximum altitude: 2000m

Installation category: 50V CATIII

Pollution degree: 2 (according to IEC61010-1)

Storage temperature: -20°C...+50°C

Operation temperature: 0°C...+40°C

Relative humidity: up to 90% non condensing @ 31°C

IP Rating: IP 53 with lid open

IP 67 with lid closed

1.4.4 Lead resistance

The DO7PLUS will operate with long lead lengths providing the maximum lead resistance does not exceed the following:

Current Leads Maximum resistance 60mΩ each lead (120 mΩ total)

Potential leads Maximum resistance 1kΩeach lead (2kΩ total)

1.4.5 DC Power Input

9–36VDC, 4A max

1.4.6 External Mains Power Unit

External mains psu 90V...253V, 47Hz...63Hz. Interchangeable leads International use (only one lead supplied with instrument).

1.4.7 Battery Operation

Two internally fixed NiMH battery packs, with gas gauge circuits to monitor battery capacity. An internal battery charger for each battery provides intelligent charging with automatic fast and maintenance charging as required. The percentage of full charge for each battery is indicated on the LCD display.

1.4.8 Weight and Size

Size: 358 x 269 x 155 mm (W D H)
Weight: 6.0 kg instrument only
Weight Packed: 8.5kg

2 About the DO7PLUS

This section introduces you to the features and functions of the DO7PLUS Microhmmeter

2.1 IMPORTANT SAFETY INFORMATION



If this instrument is used in a manner not specified in this document the protection provided by this instrument may be impaired.



The instrument and all associated cables and leads must be checked for signs of damage before the instrument is operated.

GENERAL

This instrument has been designed and tested to comply with the Electromagnetic Compatibility Directive 89/336/EEC and Low Voltage Directive 93/68EEC in accordance with EN 61010 -1 :2001 CatIII <50V relating to the safety requirements for electrical equipment for measurement, control and laboratory use.

Before connecting the instrument to the mains supply, please ensure the following safety precautions have been read and understood.

SAFETY SYMBOLS

The following symbols are used to describe important safety aspects of this instrument. These symbols appear on the instrument and in the operation instructions.



Attention Symbol: Indicates a potentially hazardous condition exists and that it is necessary for the operator to refer to the instruction manual to ensure the safe operation of this instrument.



Caution - Risk of Electric Shock: Indicates hazardous voltages may be present. Refer to the instruction manual for further safety information.

SUMMARY OF SAFETY PRECAUTIONS

The following general safety precautions must be observed while operating or servicing this instrument. Failure to comply with these precautions may result in personnel injury or death.

LIVE CIRCUITS DANGER

Do not connect the power supply to, or operate this instrument with, the protective covers removed. Component replacement and internal adjustments must be made by qualified service personnel. Do not replace components with the power cable connected. Under certain conditions, dangerous voltages may exist with the power cable removed. To avoid injuries always disconnect power and discharge circuits before touching them.

DO NOT MODIFY THIS INSTRUMENT OR SUBSTITUTE PARTS

Because of the danger of introducing additional hazards, do not perform any unauthorised modification or install substitute parts to the instrument. Only fuses with the rated current, voltage and specified type should be used. Failure to do so may cause an electric shock or fire hazard. Return the instrument to CROPICO for service and repair to ensure the safety features are maintained.

DO NOT OPERATE IN EXPLOSIVE ENVIRONMENTS

The operation of this instrument in such an environment constitutes a safety hazard.

CERTIFICATION

CROPICO certifies that this product met its published specifications at the time of shipment from our factory. All calibration measurements performed in the manufacture of this instrument are traceable to National and International standards.

ASSISTANCE

For after sales support and product service assistance please contact CROPICO Customer Support Group. Contact information is provided in the operation instruction manual.

2.2 Unpacking the instrument

When you unpack the DO7PLUS, check that the following items are present before starting to use the unit:

- 1 x Printed Operating Instructions
- 1 x DO7PLUS Microhmmeter
- 1 x Power supply unit
- 1 x CDROM
- 1 x Calibration Certificate
- 1 x Standard lead pack LS05-P
- 1 x Standard USB lead
- 1 x RS232 lead
- 1 x Warranty Card

Please contact the CROPICO Customer Support Team immediately if any of these items are missing or damaged.

Please note that we offer a wide selection of measuring leads and test fixtures, see section 9. Please consult our sales staff to order the items most suited to your application.

2.3 Cleaning Instructions

The instrument should be cleaned using a soft cloth slightly dampened with water. No other cleaning solvents should be used as these may damage the surface of the instrument.

2.4 Battery Pack Replacement

- Ensure all leads are removed from the front panel of the instrument.
- Ensure the instrument is turned off.
- Remove the 10 front panel screws and sealing washers and store in a safe place.
- Carefully lift out the front panel together with the main measuring unit.
- Remove both plugs from the battery pack by simply pulling them out.
- Place the unit safely to one side.
- Remove the 3 screws and sealing washers from the rear of the case and store in a safe place.
- The battery pack can now be lifted out of the case.
- Place the new battery pack (Cropico part no 551A675) in the case and refit the rear panel screws and sealing washers.
- Plug the main unit battery leads back into the battery.
These are colour coded – if the plugs are fitted into the wrong sockets no damage will be done, but the instrument will not operate.
- Ensure the plugs are fully inserted
- Replace the main unit and secure with the front panel screws and sealing washers.
- Turn the power on. Three warning beeps will alert you to the LCD message that new batteries have been fitted. Press 'OK' to continue.
- It is strongly recommended that the batteries be fully recharged. This will ensure the internal "gas gauge" circuits are correctly calibrated.
- Do not open the battery pack, but return to Cropico for safe disposal.

2.5. The Front Panel

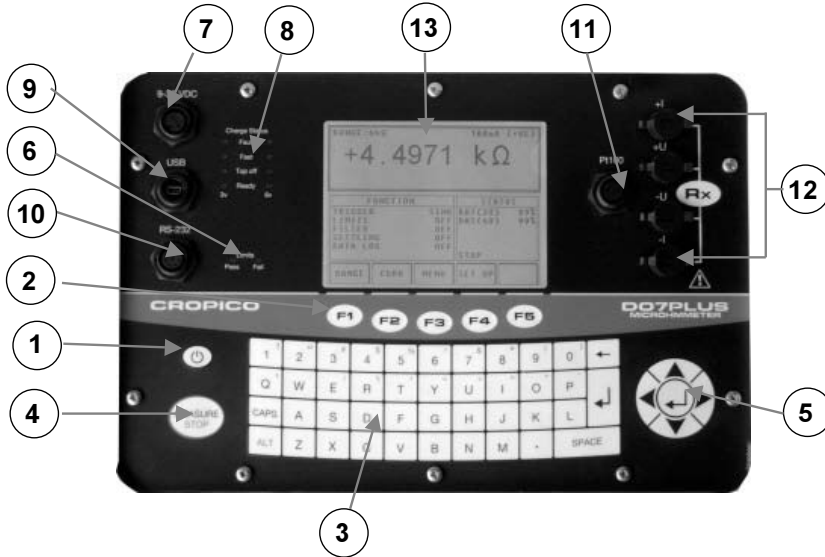

ON/OFF Switch 1

The On/Off switch switches the DO7PLUS on and off. The last measurement and function setup is restored at power on. Auto switch-off to preserve battery life may be set between 10 and 60 minutes.

2 **The Function Keypad F1...F5**

All DO7PLUS measurements and programming facilities are accessed through the function keypad (F1...F5). A brief description of these key functions are given in the following table. For a detailed description of how to use the keys to configure and operate the DO7PLUS, refer to section 4

Key Symbol	Description	Function
F1	RANGE	Manual or automatic range can be set
F2	CURR	Current mode can be selected +I , -I, Average, or Zero
F3	MENU	Displays all measurement configuration details
F4	SET UP	Displays DO7PLUS configuration including date, time, language etc.
F5	EXIT/ADD NOTE	If datalog is on & has one or more entries allows test notes to be added

QWERTY Keypad 3

The full QWERTY keypad allows notes to be entered against logged measurement values

MEASURE / STOP 4

Starts and stops the measurement in continuous measurement mode. Triggers measurement in single measurement mode.

Navigation and enter Key 5

Moves display cursor and confirms selection.

LIMITS Pass / Fail LEDS 6

When limit function is set the green led lights to confirm measurement is within limits. Red led lights if the measurement is outside the set limits.

Power input socket 7

For connection of power supply or optional car lead to charge batteries.

Charger status Indicator 8

LEDS indicate state of battery charging.

USB Socket 9

For connection of USB cable enabling full computer control.

RS232 Socket 10

For connection of RS232 cable enabling full computer control.

Pt100 input Socket 11

For connection of Pt100 temperature sensor.

Measurement input sockets 12

Prior to connecting this instrument always ensure that the circuit under test is electrically isolated. Connecting this instrument to circuits which have not been isolated could lead to a hazard.

Four 4mm safety sockets for connection of measurement leads.

Measurement Display 13

Displays measured values and information screens.

3 GETTING STARTED

3.1 Battery Charger

The DO7PLUS is powered by two internal NiMH batteries. A 6V battery supplies power to the display and operating circuits, and a 3V battery supplies the measuring current. Once the power supply is connected to the socket (7) charging is automatic and regulated to ensure the batteries are kept in the best possible condition. Charge status LEDS (8) show the charging status for each battery independently. The green READY LEDS will light when batteries are sufficiently charged for a measurement. The TOP-OFF LEDS indicate a low maintenance current and the FAST LEDS indicate the batteries are being charged with maximum current. If a fault condition occurs then the FAULT LEDS will illuminate. Should this occur the instrument should be taken out service and returned to a Cropico service centre for investigation and rectification. The power supply should not be opened, dismantled or mechanically interfered with.

In addition to the mains power supply provided with the DO7PLUS, a charging lead with car style plug is available as an option enabling the DO7PLUS to be charged with 12 or 24 Volts DC whilst away from base.

Note: To ensure correct charging operation, the DO7Plus must be switched off during battery charging.

3.2 About the DO7PLUS Display screen

The display is a graphic LCD panel with backlight giving good readability and contrast. Full measurement information is displayed with the measured value in large bold text. The measurement set-up parameters are shown in a clear and unambiguous way.

Figure 3.2.1 - Example of Resistance Measurement Mode

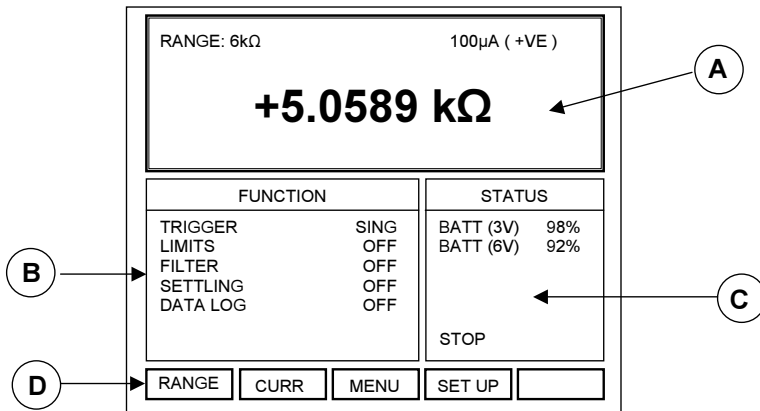

Measurement Window**A****Displays:**

- Measured value with sign and units.
- The selected measurement range, current and measurement mode.
- RX+ and RX- value when in average mode.
- Compensated value and measured Rx value plus temperature when in temperature compensation mode.

Function Window**B****Displays :**

- Trigger mode selected
- Limits status (OFF, <<Hi>>, <<Lo>> , >>OK<<)
- Filter settings
- Settling settings
- Data Log Status
- Timer (if active)

Status Window**C****Displays :**

- Battery charge state in % of full charge
- Memory number
- Remote status
- Measure / Stop condition

Function Soft Keys**D**

- Five soft keys give access to setup menus

4 Instrument Set-up

4.1 Setting the DO7PLUS instrument configuration

These are the instrument housekeeping settings and once your preferences are selected and stored they will seldom need to be changed.

To select and change a setting proceed as follows:-
PRESS F4 (SETUP) and the following screen will display

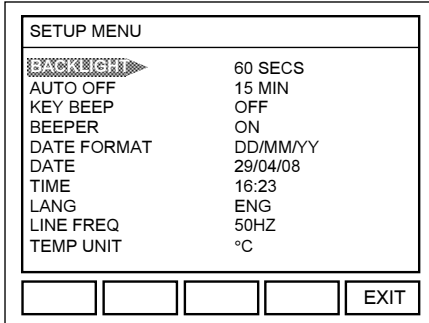

HINT: To navigate around the screen use the navigation arrows



Where an item is highlighted with an arrow  this indicates that additional options are available for that parameter and the right navigation arrow should be pressed to reveal those options.

The table Fig. 4.2.1 below shows the options available together with a brief description

4.2 F4 SETUP

To enter the configuration menu PRESS F4 (SETUP) the following can then be set.

Fig4.2.1

FUNCTION	OPTIONS		Description
BACKLIGHT	OFF		Switches backlight OFF
	ON		Switches Backlight ON
	AUTO	10–60 seconds	Automatically switches off after 10...60 seconds selectable
AUTO OFF	OFF		Disables Auto-OFF
	ON	10-60 minutes	Automatically switches off after 10...60 minutes selectable
KEY BEEP	OFF		Switches beep on key press OFF
	ON		Switches beep on key press ON
BEEPER	OFF		Switches warning Beep ON or OFF
	ON		
DATE FORMAT	DD/MM/YY MM/DD/YY		Displayed date format may be selected
DATE	28/04/08		Correct date may be entered
TIME	11:37		Correct time may be entered
	(HH:MM)		
LANGUAGE	ENG		Selects English Language
	FRA		Selects French Language
	DEU		Selects German Language
LINE FREQUENCY	50Hz		Selects 50Hz line frequency
	60Hz		Selects 60Hz line frequency
TEMPERATURE UNIT	°C		Selects °C temperatures for display
	°F		Selects °F temperature for display
REMOTE	BAUD RATE	9600	Selects interface baud rate
		19200	
	TALK ONLY	OFF ON	Switches Talk Only mode OFF or ON
VERSION	Ver 1.0		Version of firmware installed
PASSCODE			Enables Passcode to be changed, Passcode is required for calibration menu and to update firmware. Factory set Passcode = 9252
CAL			See section 6 for Calibration Mode

4.3 Setting the DO7PLUS Measurement Configuration

To set or change a measurement configuration PRESS F3 (MENU) and the following screen will display

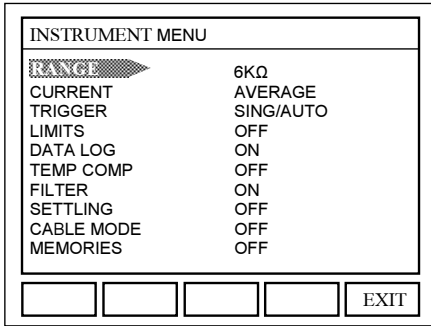

HINT: To navigate around the screen use the  navigation arrows

Where an item is highlighted with an arrow  this indicates that options are available for that parameter and the right navigation arrow should be pressed to reveal those options.

The table Fig. 4.4.1 below shows the options available together with a brief description

4.4 F3 MENU (Measurement Configuration)

To enter the measurement configuration menu PRESS F3 (MENU) the following can then be set. Fig 4.4.1

FUNCTION	OPTIONS	OPTIONS 2	DESCRIPTION
RANGE	6KΩ		Selects the range required or automatic range selection. AUTO1 selects automatic ranging starting with the 6kΩ range. AUTO2 selects automatic ranging starting from last selected range
	600Ω		
	60Ω		
	6Ω		
	600mΩ		
	60mΩ		
	6mΩ		
CURRENT MODE	AUTO1		
	AUTO2		
	+I		Selects measurement current in positive direction
	-I		Selects measurement current in negative direction
TRIGGER	AVERAGE		Measures with +I then with -I and displays average
	ZERO		Measures emf in circuit and deducts from measurement
	MEAS	SINGLE	Single pulse measurement
		CONTINUOUS	Continuous measurement
LIMITS	AUTO	MAN	Manual trigger with measure key
		AUTO	Automatically triggers measurement when test leads are connected
LIMITS	OFF		Switches Limits OFF
	ON		Switches Limits ON
	MAX	MAX LIMIT =	Set Limit Max Value
	MIN	MIN LIMIT =	Set Limit MIN Value

FUNCTION	OPTIONS	OPTIONS 2	DESCRIPTION	
DATA LOG	OFF		Switches Data Log OFF	
	ON		Switches Data Log ON	
	REVIEW		Displays logged measurements	
	DELETE	DELETE DATA LOG	Deletes all logged values	
	No RDGS	Number of readings =	Enter number of readings	
	TIMER	Timer Interval =	Enter time interval between logged readings	
	STATS	FROM		Enter log starting number for stats calculation
		TO		Enter log ending number for stats calculation
GRAPHICS	MODE DATD RANGE STATS EXIT		See section 5.10.7 for details of Graphics	
TEMP COMP	OFF		Switches temperature compensation OFF	
	ON		Switches temperature compensation ON	
	TEMP	Pt100		Selects temperature measurement with Pt100 external probe
		MANUAL	Temperature =	Enter temperature manually
	COEFF	Cu (3930)		Temperature coefficient of copper 3930ppm/°C
		Al (4030)		Temperature coefficient of Aluminium 4030ppm/°C
		USER 1	Coefficient =	Enter temperature coefficient
USER 2		Coefficient =	Enter temperature coefficient	
REF TEMP	Reference temperature =		Enter temperature 0 to 50°C	
FILTER	OFF		Switches FILTER OFF	
	ON		Switches FILTER ON	
	No RDGS	Number of readings =	Enter number of readings between 2 and 50 to be averaged	
	RESET		Resets filter average to zero	
SETTLING	OFF		Switches SETTLLING OFF	
	ON		Switches SETTLLING ON	
	No RDGS	Number of readings =	Enter number of readings to be within settling limit 2 to 999	
	LIMIT	Settling Limit =	Enter number of digits change permitted 1 to 999	

FUNCTION	OPTIONS	OPTION 2		DESCRIPTION
CABLE MODE	OFF			Switches cable mode OFF
	Ω LENGTH	No CABLES	Cables =	Enter number of cables to be measured
		CONN	Series	Cables connected in series
			Parallel	Cables connected in parallel
		LENGTH	Length =	Enter length of cable
	UNIT	METRE KILOMETRE	Select units required	
	LENGTH	No CABLES	Cables =	Enter number of cables to be measured
		CONN	Series	Cables connected in series
			Parallel	Cables connected in parallel
		RES/m	Resistance =	Enter resistance of cable in Ω /m
UNIT	METRE KILOMETRE	Select units required		
MEMORIES	F2 RECALL	Select Memory Number	Recalls all settings for memory number recalled	
	F3 STORE	Select Memory Number	Saves all settings in memory number selected	
	F4 CLEAR	Select Memory Number	Deletes all stored data in memory number selected	
	F5 LIST		Lists all memory status	

4.5 Setting the Instrument Range

Some of the measurement functions need to be changed more frequently than others and these may accessed directly, to change the RANGE settings PRESS F1 and the following screen will display.

F1 RANGE

The F1 function key will take you straight to the range set-up menu

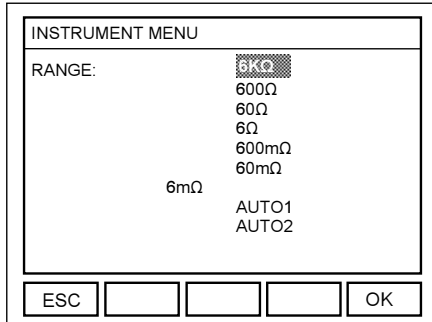

HINT: To navigate around the screen use the navigation arrows



To select the highlighted range PRESS OK (F5) or the carriage return key 
 Pressing the left arrow will return you to the measurement screen without selecting the new highlighted range.
 Pressing F1 (ESC) escapes the range menu and returns to the measurement screen without updating the range.

AUTO RANGE

Two modes of auto-range may be selected AUTO1 where the DO7PLUS will start at the highest range and work down. AUTO2 selects the last range used and then ranges up or down.

HINT: The AUTO2 will often find the correct range the fastest
 AUTO1 will always start with the highest range which uses the smallest measuring current and will avoid overheating temperature sensitive devices.

Do **NOT** use Auto-range when measuring inductive devices e.g. motors and transformers.
 Fig 4.6.1 Measuring ranges with maximum current and resolution

Range	Measuring Current	Resolution
6.0000mΩ	10A	100nΩ
60.000mΩ	1 A	1μΩ
600.00mΩ	100mA	10μΩ
6.0000Ω	10mA	100μΩ
60.000Ω	1mA	1mΩ
600.00Ω	100μA	10mΩ
6.0000kΩ	100μA	100mΩ

4.6 Setting the Measurement Current Mode

F2 Current

The F2 function key will take you directly to the measurement current set-up menu

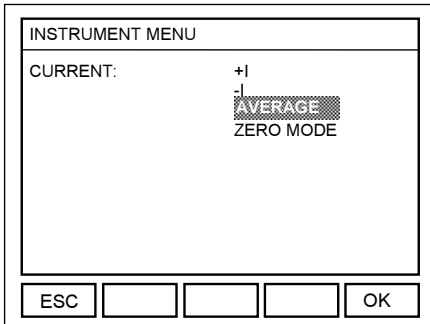

HINT: To navigate around the screen use the navigation arrows



To select the highlighted mode PRESS OK (F5) or the carriage return key ↵
 Pressing the left arrow will return you to the measurement screen without selecting the new highlighted range.
 Pressing F1 (ESC) escapes the range menu and returns to the measurement screen without updating the range.

- + I** The measurement current flows in the positive direction
- I** The measurement current flows in the negative direction
- AVERAGE** The measurement is made with +I current then a second measurement with -I current, and the average value of the two measurements is displayed. The average measurement will eliminate the effects of thermal emf and is recommended for all resistive measurements.

WARNING: The AVERAGE mode should **NOT** be used when measuring inductive samples such as transformers or motor windings. In these cases use the +I mode which will give continuous and uninterrupted measurement current, ensuring the inductance is fully charged and the correct reading displayed.

4.7 ZERO MODE

The DO7PLUS uses a four-wire internal zero measurement. The current terminals are internally shorted together and the first measurement made. The potential terminals will measure any emf in the circuit and this value is stored. A second measurement is then performed with the current and potential leads connected in the normal way. The stored emf is deducted from this measurement and the resulting value displayed. This measurement mode eliminates errors due to emf flowing in the circuit.

- In single trigger mode the DO7PLUS will perform a zero measurement for each measurement triggered.
- In continuous measurement mode one zero measurement is made followed by continuous normal measurements until the measurement is stopped. If the measurement is restarted, then another zero measurement is made followed by continuous measurements.

If a range change is made, either manually or by the auto-range function, or a measurement error occurs, then a new zero measurement will be performed.

4.8 Short cut keys enable quick access to menus

Short cut Key	Function Menu
ALT + T =	TRIGGER
ALT + L =	LIMITS
ALT + F =	FILTER
ALT + S =	SETTLING
ALT + D =	DATA LOG
ALT + C =	TEMPERATURE COMPENSATION
ALT + G =	GRAPHICS
ALT + M =	MEMORIES

4.9 F3 MENU OPTIONS EXPLAINED

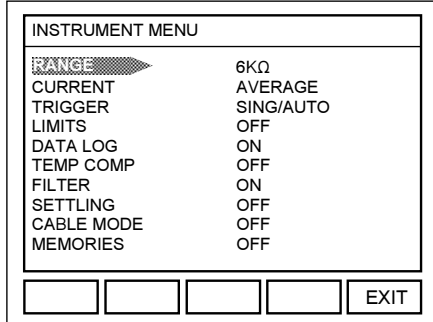

4.9.1 RANGE:

See Range selection 4.5

4.9.2 CURRENT:

See Current selection section 4.6

4.9.3 TRIGGER:

Fig. 4.9.1

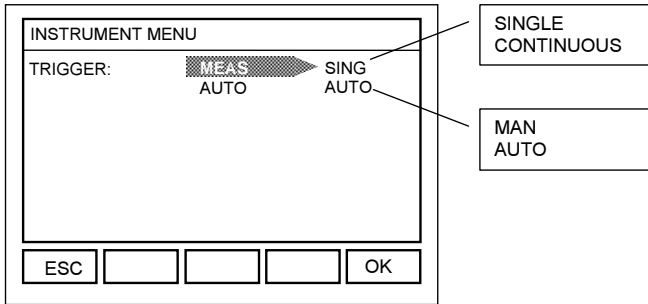

The DO7PLUS measurement can be triggered in several ways.

Setting Single or Continuous Measurement Mode

The DO7PLUS may be set to continuous or single measurement mode.

When in the TRIGGER menu window select **MEAS**  Fig: 4.9.1 press the right navigation arrow key and then select either SINGLE or CONTINUOUS. Once this mode is set it will apply to both the manual and automatic trigger modes. Press OK (F5) to accept choice.

Single Measurement Mode

When this mode is set, a single pulse measurement will be made and the value held on the display.

HINT: This mode is particularly useful when you want to avoid the self heating effect of the measurement current.

WARNING: this trigger mode is **NOT** suitable for measuring inductive samples such as transformers or motor windings. For these applications a continuous measurement current should be used.

Continuous Measurement Mode

If continuous measurement is selected then the measurement will start when the MEASURE/STOP button is pressed. The measurement current will flow continuously in the +I and -I current modes and will be continuously switched in the AVERAGE current mode. Continuous measurements will be taken and displayed, to Stop the measurement press the MEASURE/STOP key and the measurement current will be disconnected and the last measured value held on the display.

Setting Manual or Automatic Measurement Mode

To set the measurement for manual or automatic triggering select Auto when in the trigger menu **AUTO**  press the right hand navigation arrow key and then select either MAN for Manual triggering or AUTO for automatic triggering. Press OK (F5) to accept choice.

Manual Measurement Mode

In this mode all measurements are started and stopped manually using the MEASURE/STOP key. When the measurement is stopped the measuring current is disconnected and the last measured value held on the display.

Remote manual triggering

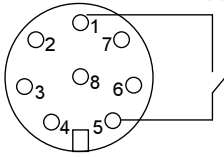

DO7PLUS RS-232 CONNECTION SOCKET

Pins numbered as viewed from rear of plug (cable side)

- PIN 1 ... REMOTE START
- PIN 5 ...GROUND

As an alternative to pressing the MEASURE/STOP key to trigger, a measurement, the remote start facility can be used. Connect a switch between pins 1 and 5 of the RS232 input connector and close the contacts to start a measurement.

HINT: Connecting a footswitch or measuring probe with an external start button permits single person operation. Values can be stored in the datalog for future analysis.

Automatic Measurement Mode

In this trigger mode the system allows a measurement to be taken simply by connecting the measurement leads to the test piece. The measurement will not be triggered if the display is in the menu mode.

Automatic measurement in single mode:

In most modes (Simple, Limits, Filter, Settling, Autorange, Temp Comp, any current mode, and normal Datalog), Auto trigger causes one complete measurement to be made and held on the display.

When in Datalog Timer mode:

Auto trigger starts to take the prescribed number of measurements at the selected timer intervals.

HINT: Removing and replacing the measurement leads will have no further effect, other than causing an error indication.

Automatic measurement in continuous mode:

In most modes (Simple, Limits, Filter, Settling, Autorange, Temp Comp, any current mode, and normal Datalog):

Auto trigger starts continuous measurements.

HINT: Removing and replacing the measurement leads will have no further effect, other than causing an error indication.

Automatic measurement when in Datalog Timer mode:

Auto trigger starts to take the prescribed number of measurements at the selected timer intervals, maintaining the current at all times.

Hint: removing and replacing the measurement leads will have no further effect, other than causing an error indication.

4.9.4 LIMITS

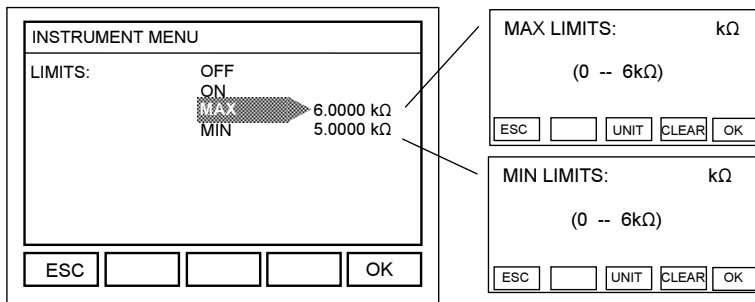

From this menu the LIMITS function may be switched ON or switched OFF. The Maximum (MAX) and Minimum (MIN) limit value may also be selected.

To switch the LIMITS ON or OFF with the required option highlighted PRESS OK (F5) to set. The display will return to the previous screen.

Against the MAX and MIN options the limit values previously set are displayed. To change the limit value highlight the MAX or MIN and select with the right navigation arrow, a new window will display. In this window the new limit value can be entered. Options to change the UNITS or CLEAR the digits set will be found on the function keys. Once the required limit value is set, accept with the OK function key (F5) and the display will return to the previous menu.

LIMIT PASS / FAIL

Once the limit values are set and the limit option turned ON, the DO7PLUS will monitor all measurements to ensure that they fall inside the MAX and MIN values. For measurements inside the limits the green Pass led on the front panel will illuminate and <<OK>> will be displayed in the FUNCTION window of the measurement screen. If the measured value is outside the limit range set then the red Fail led on the front panel will illuminate and the FUNCTION window of the measurement screen will display >>Hi>> for values above the set limit and <<Lo<< for values below.

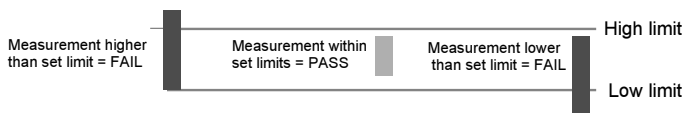

4.9.5 DATA LOG

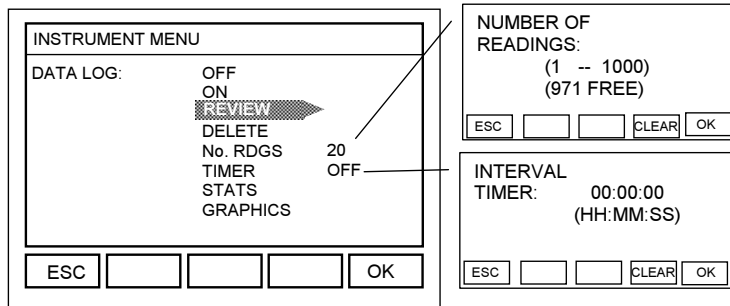

The DO7PLUS comes complete with a Data Logging facility. Up to 1000 readings may stored with date and time stamp. Readings may be stored manually or logged using the built in timer. Logged values can be reviewed in either graph or table format and statistical analysis of the stored values may be displayed.

Number Readings

To select the number of readings to be stored in the log, highlight No. RDGS in the DATA LOG menu screen. The number of readings currently set will be shown. Use the right navigation arrow key to select the next screen. The number of measurements, up to 1000, to be stored can now be entered. If the log already has stored values then these may first be cleared with F4 function key or the new measured values added to the log. The screen will indicate the number of free stores available.

DATALOG TIMER

OVERVIEW

The purpose of the Datalog Timer is to allow measurements to be made at a selected interval without intervention from the user. (This can also be achieved via the remote interface, but the timer allows this without a PC).

Once set up, and the measurement is started, an immediate measurement is taken, followed by the prescribed number of measurements at the selected timer intervals.

The difference between SINGLE and CONTinuous measure mode is that in SING, the measuring current is applied only during each measurement, whereas in CONT mode, the current is on all the time, allowing for example, timed measurements of an inductive load.

TIMER SETTINGS

In the Datalog menu, the Timer can be set in HH:MM:SS format from 00:00:00 (Off) to a maximum of 23:59:59.

The Number of Readings can also be set from 1 to 1000 so care must be taken to ensure that the time interval is compatible with the number of readings and the data log free capacity.

TIMER OPERATION – ADDITIONAL NOTES

- If AUTO1 autorange is set, then the top range will be set at the start of the first measurement. After that, the autorange will operate as if it were in AUTO2 mode, ie only change range (in either direction) if required.
- The Settling Algorithm (see section 4.9.11) is reset at the start of every measurement. Note that in Continuous mode, like the timer-free situation, the current is disconnected and measurement ceases at the end of a Settling Algorithm measurement.
- If in Zero current mode, a Zero measurement is only taken on the first measurement, unless autorange changes the range.

REVIEW

Fig 4.9.5 review screen of data logged values

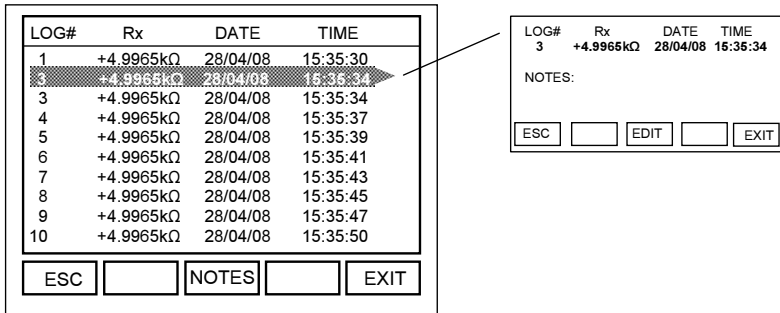

The logged measurements can be displayed in a table format (Fig 4.9.5)with date and time. The log can be scrolled through using the navigation arrows and the highlighted entry can be selected with the right arrow navigation key, notes can then be added to the entry using the keyboard. Up to 1 line (33 characters) of text per logged value may be entered.

4.9.6 STATS

From the logged measurement values a statistical analysis can be displayed. The DO7PLUS will automatically calculate the Maximum, Minimum, Mean value, Peak to Peak value and Standard deviation.

Select the STATS option from the Data Log window and press the right navigation arrow to display the first stats window. In this window the starting (FROM) and finishing (TO) logged values to be analysed can be set. When the values have been entered press OK (F5), and the selected logged value statistics will be displayed.

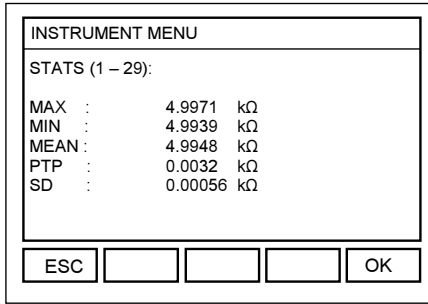

HINT: STATS will only be calculated and displayed from measurements with the same measuring conditions. E.g. Changing ranges will prohibit the STATS display.

4.9.7 GRAPHICS

The DO7PLUS has the ability to plot graphs from the logged values. Once the datalog has been configured and values stored, select the GRAPHICS option from the DATA LOG menu screen using the right navigation arrow.

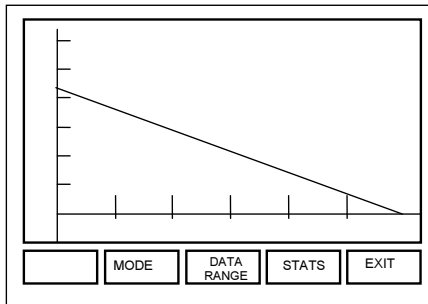

PRESS F3 (DATA RANGE) and enter the logged data numbers in the FROM /TO dialog box and PRESS F5 (OK) to accept.

To select the graph type PRESS F2 (MODE) the dialog box allows the following selection.

- SCATTER
- LINEAR
- LINE FIT
- COOLING CURVE

For the COOLING CURVE additional data needs to be set up but for the other three options the graph is automatically formatted and displayed. From the GRAPHICS window the STATS (F4) can also be displayed for the data range selected PRESS F4 (STATS).

4.9.8 COOLING CURVE

The COOLING CURVE function is a very powerful feature of the DO7PLUS and enables the maximum temperature of a machine, running under full load, to be automatically calculated and displayed in both graphical and table formats.

Select the COOLING CURVE function using the right navigation arrow. The following can now be set:

- TIME DELAY – This is the time between switching off the machine and the first valid measurement.
- AMBIENT TEMPERATURE – This is the ambient temperature at which the measurements are made.
- Rnom - The cold resistance measured at ambient temperature.
- Tnom - The ambient temperature at which Rnom is measured
- TEMPERATURE COEFFICIENT - This is the temperature coefficient for the material being measured, for a motor winding this is normally copper. This is automatically selected from the coefficients set in the TEMPERATURE COMPENSATION Mode which must be switched ON

NOTE: When the temperature compensation is switched on then AMBIENT TEMPERATURE and Tnom will be the temperature compensation reference value, normally 20°C.

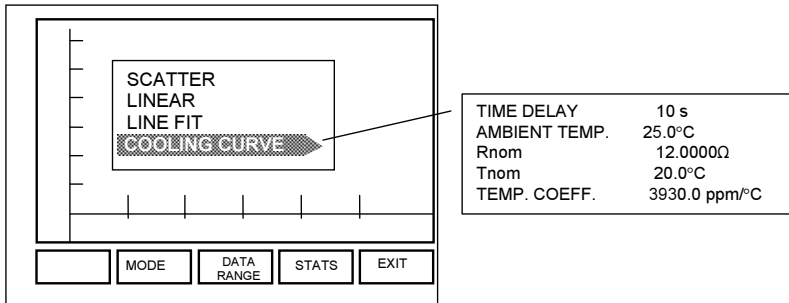
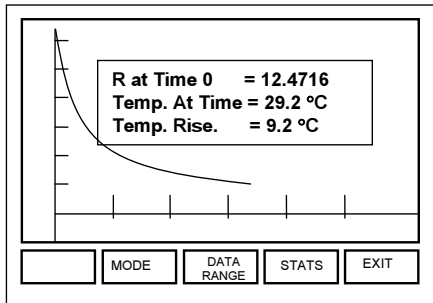

Fig: 4.9.8 Cooling Curve display



IMPORTANT

When datalogging readings, for use with the COOLING CURVE function, the following should be set:

- CURRENT = +I
- TRIGGER = Continuous
- AUTORANGE = OFF
- TEMPERATURE COMPENSATION = ON with Pt100 sensing
- FILTER = OFF
- SETTling = OFF
- COEFFicient should be set for correct material

4.9.9 TEMPERATURE COMPENSATION

Temperature compensation is included in the DO7PLUS and should be used when measurements are required to be referenced to a set temperature, normally 20°C. This is particularly useful when measuring materials with a high temperature coefficient such as copper. As the ambient temperature varies so will the resistance value of the copper. Using the temperature compensation mode references all values back to a reference temperature. The DO7PLUS displays both the temperature compensated value, and the true resistance value measured, together with the reference temperature and the actual measurement temperature. This ensures that the user has all the measurement information and reference conditions readily available.

Fig:4.9.9 Measurement Display screen in temperature compensation mode

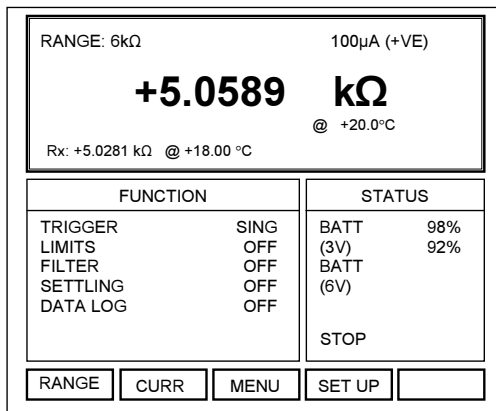

Setting the Temperature Compensation Parameters

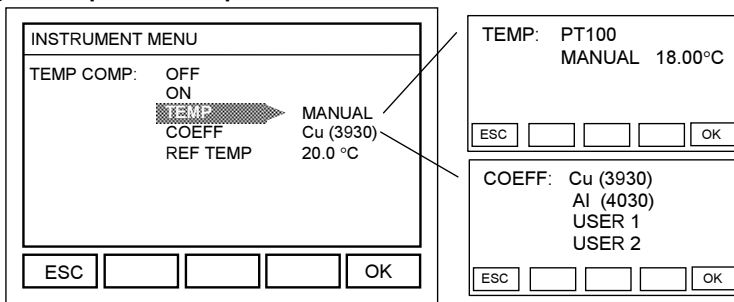

From the MENU window F3 the temperature compensation can be switched ON or OFF. The measurement temperature can also be set to either MANUAL or Pt100. If the Pt100 option is selected then the ambient temperature will be measured with a Pt100 temperature sensor (available as an option). If the Manual option is selected using the right navigation arrow, then a new window permits the entry of the required temperature over the range 0 to 100°C

HINT: Once the manual temperature is selected this temperature value is used for all measurements. This mode should only be used in known stable ambient conditions.

If the Pt100 option is chosen then a Pt100 sensor should be connected to the front panel socket see section 2.2.1 (11) The Pt100 sensor will continuously measure the ambient temperature and correct the measured resistance values accordingly.

HINT: For best measurement results always use the Pt100 mode.

Connections for Pt100 sensor

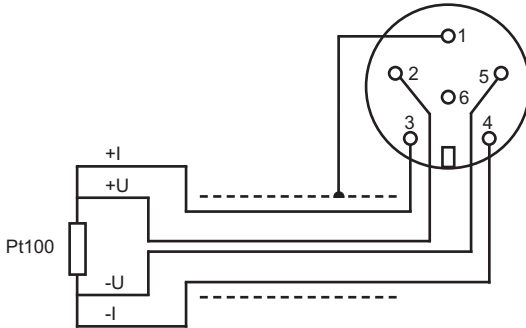

Pin numbers as viewed from rear of plug (cable side)

- PIN 1 ...Screen
- PIN 2 ...+U
- PIN 3 ...+I
- PIN 4 ...-I
- PIN 5 ...-U
- PIN 6... NC

COEFFicients

Different materials have different temperature coefficients, which mean that their resistance changes by different amounts with temperature. The most common materials used for making electrical components are copper and aluminium and the coefficients for these materials can be selected from the COEFF window. It may be necessary to measure other materials and provided the temperature coefficients are known they can be entered in one of the USER configurations. Select USER 1 using the right navigation arrow and the material temperature coefficient can be entered in the range 0 to 9999 ppm/°C. When entered, PRESS OK (F5) to accept and store the value and return to the previous window.

REFERENCE TEMPerature

The temperature compensated measurements are normally referenced to a temperature of 20°C but sometimes circumstances or test specifications require a different reference temperature. Select REF TEMP in the temperature compensation window using the right navigation arrow and then enter the required reference temperature in the range 0 to 50°C

4.9.10 FILTER

The measurement filter is a rolling average filter and should be used to smooth the display reading, when measuring unstable samples. The DUT (Device Under Test) may be sensitive to small changes in temperature, in which case the displayed value would be fluctuating, making it difficult and uncomfortable to read the measured values. In these cases the FILTER may be switched ON and a number of readings averaged the number of readings selected to average will depend upon the severity of fluctuation, but 2 to 5 is normally sufficient. From the FILTER set up screen readings may be set between 2 and 50. The average displayed is a rolling average which means that if the filter was set to 5 then five measurements are taken and averaged and the result displayed. The next reading would be added to the first five, and the first reading deleted a new average would then be displayed.

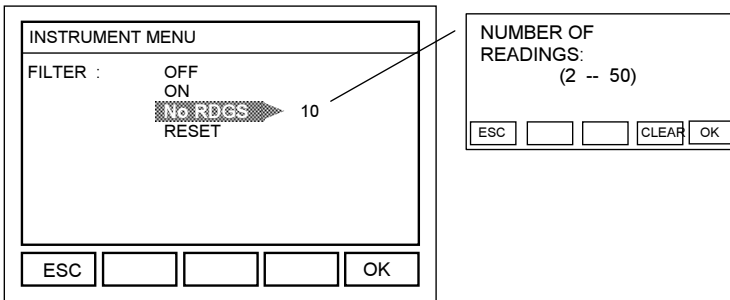

4.9.11 SETTling

The settling algorithm is particularly useful when measuring inductive devices such as motors, generators and transformers. With such devices it can take several seconds, and in the more extreme cases minutes, for the ohmmeter measuring current to charge the inductance and provide a steady and stable reading. When the settling algorithm is selected, and the 'MEASURE' button pressed, continuous measurements will be made until the number of consecutive readings is within the selected limit. The value will then be displayed. If the selected number of readings is reached without the measurements settling an error message will display and the measurement stopped.

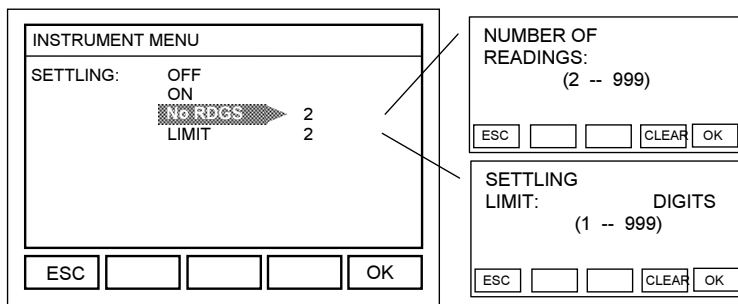

From the Settling mode window the settling function may be switched on or off. The number of settling readings and the limit of the readings may also be set.

NUMBER of READINGS

Highlight and selected, using the right navigation arrow, No RDGS in the settling window. The reading number can now be entered in the range 2 to 999.

This is the number of consecutive readings in which the measured values must fall within the limits set before that value is displayed.

SETTLING LIMIT

Highlight and select, using the right navigation arrow, LIMIT and enter the number of digits in the range 1 to 999.

This is the number of display digits by which the number of readings set may differ for the measurement to be defined as settled. The settled value will then be displayed.

If the readings do not then an error message "FAILED TO SETTLE" will be displayed and the measurement stopped.

The settling function should normally be used in the Single trigger mode, but if continuous mode is used the operation is the same except that once the measurement has settled the measurement will stop and the measurement current disconnected.

EFFECT ON OTHER FUNCTIONS

Selecting the Settling facility will:

- Cause the Autorange to change range in a downward direction only. (Therefore, only 'Auto1' autorange mode should normally be used.)
- Deselect the Filter function.
- Change Average current mode to Positive current mode.

PARAMETERS WHICH WILL DESELECT THE SETTling FACILITY

The Settling facility will be deselected if:

- Filter facility is selected.
- Average current mode is selected.

4.9.12 CABLE MODE

When the CABLE MODE is selected the DO7PLUS can be used to measure and calculate the length of cables as either an Ohms/Length or a Length value.

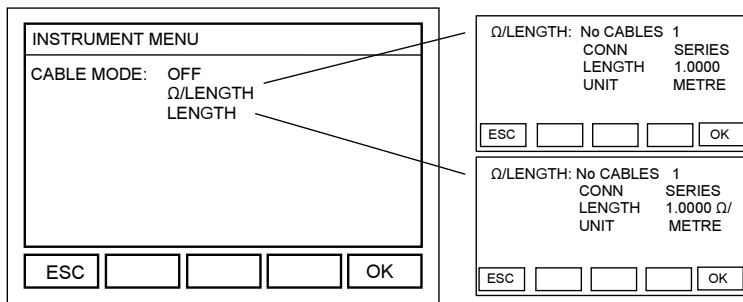

Ω / LENGTH DISPLAY

In order to obtain this, the user can enter the following:

1. No. of cables (1 – 99).
2. How they are connected (Series/Parallel).
3. Length of one cable (0 – 1000).
4. Length Unit (Metre/Kilometre).

Note that the Length Unit is for display purposes only, and no conversion is made from one unit to the other due to under/overflow of the calculation. The Ohms unit, however, does alter as necessary, from μ Ohm to MOhm.

LENGTH DISPLAY

In order to obtain this, the user can enter the following:

1. No. of cables (1 – 99).
2. How they are connected (Series/Parallel).
3. Resistance per Length of one cable (0 – 1kOhm).
4. Length Unit (Metre/Kilometre).

Note that the Length Unit is for display purposes only, and no conversion is made from one unit to the other due to under/overflow of the calculation.

4.9.13 MEMORIES

Using the MEMORY function up to 10 DO7PLUS configurations can be stored and recalled. Highlight and select MEMORIES, using the navigation arrows, in the MENU window. From this window the FUNCTION keys can be used store and recall the memories. When a memory is stored all the preset measurement parameters of the instrument will be saved, recalling a memory will reinstate those parameters.

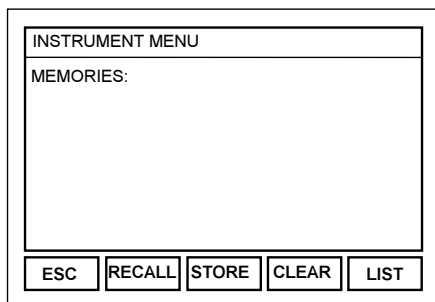

The status of the memory store can be displayed by pressing LIST (F5) this will show which memories are free and which are in use. Memories can be cleared by pressing CLEAR (F4). If a memory is in operation, this will be displayed in the Status window, if any measurement parameter is sub sequentially changed (e.g. Range), then it will no longer be displayed.

5 MEASURING WITH THE DO7PLUS

5.1 Connecting to the DO7PLUS

The DO7PLUS uses a four terminal method of measurement which eliminates errors due to lead resistance. The measuring leads plug into the four front panel safety sockets. The sockets are marked +U, -U, +I, & -I. Connections to the resistance to be measured should be as per Fig: 5.1.1

Fig: 5.1.1 Connection diagram

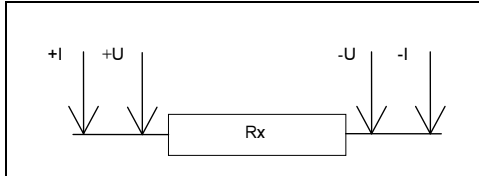

HINT: It is important to connect the I (current) leads outside the U (potential) leads

5.2 Connecting to the resistance

The Digital Microhmmeter DO7PLUS employs a four wire method of measurement, i.e. it is necessary to make four connections to the resistance under test. The instrument is supplied with four leads; two for the potential connections which are made across the test resistor at the points between which the resistance is to be determined; and two for the current connections which connect the test resistor to the current supply circuit.

Connect to the resistance under test as shown in figure 5.1.1. Cleanliness is important and if the sample is not clean, a rub with an abrasive paper to remove oxides is recommended.

It is not always possible to use the combined current and potential crocodile clips (Kelvin clips), in which case test leads with spade tags, or special fixtures may have to be made to suit the particular application. We offer a variety of different lead and fixture types which are list in section 9

Fig: 5.2.1 Diagram of different connection configurations

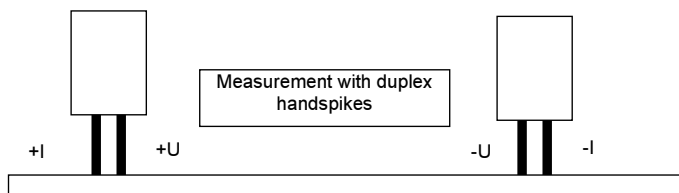
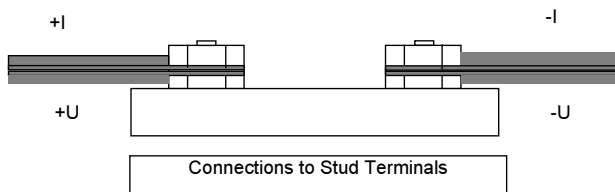
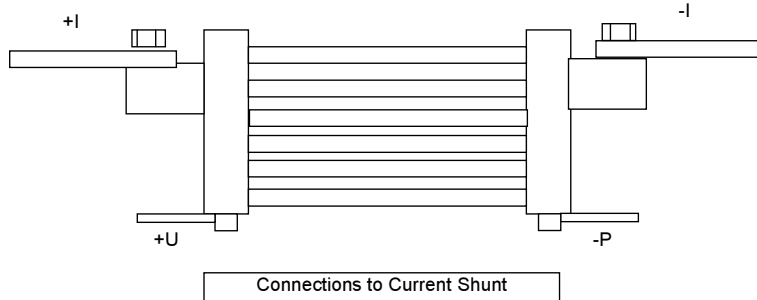
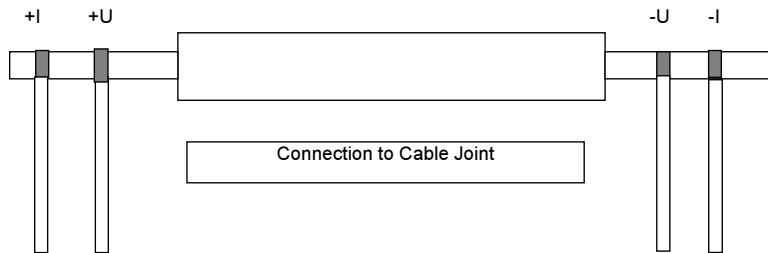

5.3 Resistance measurement

The DO7PLUS should be in the measurement [STOP] mode. In this mode the measuring current is switched off and the current terminals are shorted internally. Connect the measuring leads as described in section 5.1 Before starting the measurement select the current mode required as described in section 4.6. Select the range required see 4.5 or auto range.

WARNING the maximum measuring current is 10 Amp on the lowest measuring range ensure that the current level selected will not damage the resistance being measured

To start the measurement press the **MEASURE** button the measured resistance value will be displayed.

5.4 Resistance measurement with temperature compensation

Temperature compensation should be used when measuring the resistance of materials which have a high temperature coefficient. Copper, for example, has a temperature coefficient of 0.3930%/K. The value of the resistance measured will therefore vary with the temperature of the copper. To obtain consistent and meaningful results, the resistance values may be related to a set ambient temperature, normally 20°C.

Example: Copper with a temperature coefficient of 3930ppm/k = 0.3930%/k

Temperature	20°C	25°C	30°C	35°C
Resistance of Copper	18.000 mΩ	18.354 mΩ	18.707 mΩ	19.061 mΩ
% Increase in resistance	0%	1.96%	3.93%	5.89%

To measure with the temperature compensation, proceed as in 5.3 but in addition connect the temperature sensor probe (see section 9 for accessories details and part numbers) to the front panel socket. Select the temperature compensation measurement mode as described in 4.9.9. Alternatively, if the ambient temperature is stable, a manual value may be entered, in this case a temperature sensor is not required. The compensated resistance value will be displayed in large digits on the DO7PLUS screen and the true measured resistance value will be shown in smaller digits below the main display. The measured and set temperature will also be shown.

5.5 Effects of Lead Resistance

The DO7PLUS is a true four terminal measuring instrument and will, therefore, measure accurately with long lead lengths. The DO7PLUS monitors the lead resistance and will display an error message if the lead resistance exceeds the resistance values below. It is good practice to keep the lead lengths to a minimum, this ensure that any magnetic fields and other environmental noise that may be present have minimal effect. Sometimes long leads can't be avoided and in these cases the cable resistance should be kept to a practical minimum and not exceed the following:

- Current Leads Maximum resistance 60mΩ each lead (120 mΩ total)
- Potential leads Maximum resistance 1kΩeach lead (2kΩ total)

HINT: The accuracy of the measurement is not affected by different lead lengths, only by the resistance of the leads.

6 CALIBRATION

The DO7PLUS is designed with ease of calibration in mind and comes complete with a manufacturer's calibration certificate. A UKAS calibration certificate is also available and should be ordered with the instrument if required. The calibration should be verified annually and if necessary adjusted. The unit may be returned to CROPICO who offer a full calibration service.

For those who wish to perform their own calibration, enter the calibration mode by pressing F4 (SET UP) scroll down the options and highlight CAL in the menu.

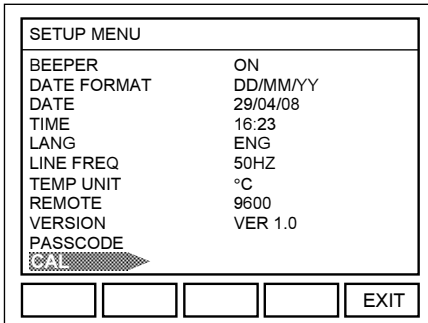

HINT: To navigate around the screen use the navigation arrows

Where an item is highlighted with an arrow  This indicates that additional options are available for that parameter and the right navigation arrow should be pressed to reveal those options.

The display will prompt you to enter a PASSCODE. The factory default passcode is 9252. Press F5 (OK) once the passcode is entered and the last calibration date and time will be displayed.

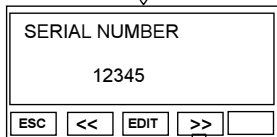
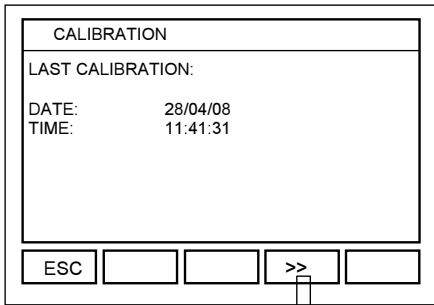

The instrument Serial number is displayed and may be edited

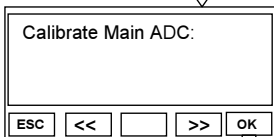

The calibration procedure prompts you with each step. To calibrate the Main ADC disconnect all measuring leads and press OK (F5)

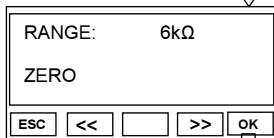

The display will indicate that the 6kΩ range is to be calibrated at the zero point. Connect a true four terminal zero to measuring terminals.

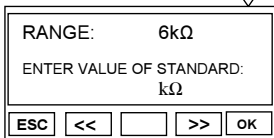

The display will now prompt you to calibrate the full scale value. Connect the appropriate calibration standard and enter its certified value. Note: the certified value should be entered and not the nominal value. Press OK (F5) and the DO7PLUS will automatically calibrate the range full scale

The calibration window will now move on to the next range value and the zero and full scale calibration repeated. At any time you can move back to a previous range with the << keys or move forward skipping a range with the >> keys.

For simple and easy calibration CROPICO offer a calibration standard model MTS2 which has all the standards required in a single switched unit. With the MTS2 true four terminal zero can also be selected.

Once all the ranges are calibrated for zero and full scale the calibration window then selects and displays the Pt100 calibration values. First 100Ω is requested and a 100Ω four terminal standard should be connected to the Pt100 input socket. Pressing OK accepts the value and the window requests that 150Ω be connected. Again pressing OK accepts the value and the calibration is complete.

HINT: The standards used should have a minimum certified accuracy of $\pm 0.01\%$ and the DO7PLUS should be placed in a temperature controlled environment at least four hours before calibration.

Once the ranges and Pt100 sensor ranges are calibrated the menu moves on to reset the battery Gas gauges. With fully charged batteries connected, highlight the 3V (ANALG) and press OK repeat for the 6V (DIG) battery

7 UPDATE FIRMWARE

The next window permits the updating of the DO7PLUS firmware, CROPICO has a programme of continual improvement and firmware updates will be available from time to time. These update will be available on CD or may be downloaded from our website www.cropico.com. The updates may be uploaded via the USB or RS232 interface and full instructions will be provided.

8 RS232 CONNECTION DIAGRAM

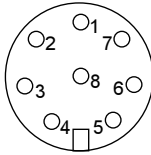

DO7PLUS RS-232 CONNECTION SOCKET

Pins numbered as viewed from rear of plug (cable side)

- PIN 1 ... REMOTE START
- PIN 2 ...RXD
- PIN 3 ...TXD
- PIN 4 ...N/C
- PIN 5 ...GROUND
- PIN 6 ...N/C
- PIN 7 ...RTS
- PIN 8 ...CTS

9 ACCESSORIES

MEASURING LEADS

The DO7PLUS may be used with a variety of lead sets. The following are the available selection. Remember, if you do not see suitable leads for your application, please consult our customer help desk.

Ordering Code	Description
HS01-P	Duplex Handspikes with 2.5 metre lead length, current and potential spikes suitable for plate or Bussbar measurements.
HS02-P	Duplex Handspikes as a HS01-P but with 2.5 and 15 metre lead lengths
LS03-P	Large Kelvin clips with 3 metre lead length suitable for attaching to rods bars or cables up to 38mm diameter
LS04-P	As LS03-P but with lead lengths 3 and 15 metres
LS05	Executive lead set consisting of 4 x 1 metre leads with banana plugs, 4 x crocodile clips 4 x test prods and 4 x Kelvin clips (KC1) jaw opening 4mm
LS06-P	Kelvin lead set comprising of miniature Kelvin clips (KC2) with 1 metre leads attached terminated with banana plugs Jaw opening 6mm. Suitable for fine wires.

WIRE CLAMPS

For the precise measurement of 1 meter cable samples we offer 3 wire clamp options.

Ordering Code	Description
C02	1 metre wire clamp with hardwood base suitable for cable diameters up to 100mm
C02-A	1 metre wire clamp with metal base and provision for temperature sensor suitable for wire cross section 1 to 1000mm
C03	1 metre wire clamp with water bath for the precise measurement of 1 meter cable samples 1 to 1000mm

TEMPERATURE PROBE

Ordering Code	Description
5000-Pt100	Pt100 Temperature Sensor Probe length 200mm, diameter 6mm. Fitted with 1 Metre Lead and DIN Plug

Ordering Code	Description
MTS2	Calibration Standard

SECTION 2
REMOTE CONTROL INTERFACE
FOR
DO7PLUS
DIGITAL MICROHMMETER
USER MANUAL
CONTENTS

1. INTRODUCTION	40
2. SETTING UP THE COMMUNICATION LINK	40
2.1 RS-232 SERIAL PORT	40
2.2 USB PORT	41
2.3 FRONT PANEL SET-UP	41
2.4 CONFIGURING THE APPLICATION	42
2.5 COMMUNICATING	42
3. PROGRAMMING THE INTERFACE	43
3.1 INTRODUCTION	43
3.2 REMOTE INTERFACE COMMANDS	45
3.3 CONFIGURATION COMMANDS	46
3.4 TRIGGER & MEASURE COMMANDS	46
3.5 DATALOG COMMANDS	48
3.6 TEMPERATURE COMPENSATION COMMANDS	49
3.7 MEASUREMENT LIMIT COMMANDS	50
3.8 FILTER (ROLLING AVERAGE) COMMANDS	51
3.9 SETTling ALGORITHM COMMANDS	51
3.10 SYSTEM RELATED COMMANDS	52

APPENDICES

I	Command Summary
II	RS-232 Pin Connections

I. INTRODUCTION

The Remote Interface permits full remote control of the DO7PLUS by an external computer. Commands enable the instrument parameters to be set and checked, measurements to be triggered, and the results obtained.

The connection between the DO7PLUS and the external computer can be made using either an RS-232 Serial Port cable, or a USB cable and driver. The RS-232 Serial Port is robust and simple to use, and the USB Port is useful for computers which do not have a Serial Port. See Section II.A or 0 as appropriate for information on how to set up the port.

Selection of the remote interface Baud Rate and Talk-Only mode are accessed from the front panel 'Set Up' menu (see Section II.B).

A PC application is required to control the DO7PLUS, and this will need to be configured (see Section II.C).

The remote commands are common to both connection methods, and generally follow the SCPI / IEEE488.2 format (see Section III).

Note that the command "SYSTem:REMOte" must be sent before the DO7PLUS will recognise remote commands or queries (see Section III.B).

II. SETTING UP THE COMMUNICATION LINK

A. RS-232 SERIAL PORT

Transfer of data is controlled by hardware handshaking, and it is recommended that the Cropico cable assembly be used for connecting the DO7PLUS to a PC. This has the full 5-wire connection, and will maintain EMC integrity, reducing the possibility of interference.

At the PC end, the cable should be connected to a spare Serial COM Port. Make a note of the number of this Port if it is labelled.

FURTHER INFORMATION

The port conforms to specification ANSI/EIA/TIA-232-E-1991 "Interface Between Terminal Equipment and Data Circuit-Terminating Equipment Employing Serial Binary Data Interchange", except that a Remote Start connection is also provided. A list of pin assignments is given in Appendix II.

Signal levels;	
MARK (logical "1");	-3V to -15V
SPACE (logical "0");	+3V to +15V

Data is transferred using the TXD and RXD lines.

Hardware handshaking for each character transfer uses the RTS and CTS lines.

RTS is an output from the microhmmeter which indicates its receiver status. When asserted (low) it indicates that it is ready to receive another character. When negated (high) the microhmmeter receiver buffer is full and cannot receive another character until the buffer is processed (if the PC sends one it may be lost). As soon as space becomes available in the receiver buffer, RTS is re-asserted to allow the PC to send the next character.

When the microhmmeter detects receipt of a line terminator character, RTS is negated whilst the command line buffer is read and validated. This is to prevent the PC sending further characters whilst a command is being validated. Following validation, RTS is re-asserted to permit the next command to be transmitted by the PC.

CTS is an input to the microhmmeter and controls the transmission of characters. If the PC asserts CTS (low) then the microhmmeter will transmit the next character from the output buffer (if one is waiting). If the PC negates CTS (high) then the microhmmeter will not transmit the character, but will wait until CTS is re-asserted. TXD will remain in the mark (low) condition whilst CTS is negated. Note that changing CTS during transmission of a character will not disrupt the transmission of that character.

If a 3-wire (TXD, RXD, GND) connection is to be used, connect RTS to CTS at the microhmmeter end. But take care; sending characters too quickly to the microhmmeter could cause its receiver buffer to overflow and subsequent characters may be lost. Use a time delay between transmitted commands, or better still, use the full 5-wire connection for reliable hardware handshaking of each character.

USB PORT

The DO7PLUS has the option of using a USB cable to provide the data link to a PC, as an alternative to the traditional RS-232 Serial Port cable. USB cables such as a standard "A to Mini B" type (Cropico Part No. 551A002) can be used, or the waterproof version.

If the PC you are using has not already been used for communicating with the instrument via the USB interface, then the USB driver will need to be installed first. The driver can be found on the CD supplied with the instrument, or can be downloaded from the Cropico website <http://cropico.co.uk>. Follow the installation instructions that accompany the driver.

Once the driver has been installed, the cable should be connected to a spare USB Port on the PC, and the instrument switched on. The PC should detect this, and confirm that the new hardware has been installed.

The driver creates a "Virtual COM Port", and it is necessary to find out the number of this COM Port. Typically, this can be determined by right-clicking on "My Computer", click on "Properties", click the "Hardware" tab, click on "Device Manager", and double click on "Ports (COM & LPT)". You should see "Cropico DO7PLUS USB Bridge (COMx)" listed, where "x" is the number of the COM Port. Make a note of this number.

Note that if more than one DO7PLUS instrument is connected to one PC, then the driver will create a separate Virtual COM Port for each instrument.

B. FRONT PANEL SET-UP

Press the "SET UP" option on the front panel and scroll down to 'REMOTE'. This allows selection of the Baud Rate and Talk Only mode.

BAUD RATE

The options are 9600 or 19200 Baud.

The data word format is fixed at;

Start bits;	1
Data bits;	8
Parity checking;	None
Stop bits;	1

For Flow Control, Hardware handshaking is used. Software handshaking using XON/XOFF is not implemented.

TALK ONLY MODE

This mode is useful for operations such as sending results directly to a printer without the need for a PC.

In this mode, the interface will ignore all incoming remote commands, and the instrument will remain in LOCAL control mode.

The result of each measurement is sent to the interface output. The value sent is the one which appears in large characters on the instrument display. This means that, for example, if Temperature Compensation is selected, then the compensated resistance value will be sent. However, if the Cable Mode is selected, then the value sent is the resistance measured, as displayed in the smaller text. See Section III.A for output data format.

REMOTE INTERFACE STATUS ON THE SCREEN

If the DO7PLUS is in remote mode, then this is indicated in the Status box as "REMOTE REM".

If the Talk Only mode has been selected, then this is indicated as "REMOTE T-O".

C. CONFIGURING THE APPLICATION

A PC application is required to control the DO7PLUS, whether custom-made software, Cropico's DataLogger (for downloading the Datalog contents), or a general purpose application such as "HyperTerminal".

The application must be configured correctly for communication to be successful. For example, if using HyperTerminal, press the "Disconnect" button, then click on the "File" menu, "Properties", select the correct COM Port as described below, and click on "Configure" for the other options. For the Cropico DataLogger, the "Configure" option is under the "Comms" menu, which is covered in the DataLogger Help.

COM PORT

This must be set to the correct number.

If the RS-232 Serial Port is being used, then the COM Port number is the one that was noted above in Section A. If the number is not known, then start with COM1, and if that does not work, try COM2 etc.

If the USB Port is being used, then the COM Port number is the one that was noted in Section 0.

BAUD RATE

This must always be set to the rate that is selected on the DO7PLUS (see B), either 9600 or 19200 Baud.

OTHER SETTINGS

If selectable, the following settings should also be made:

Data Bits:	8
Parity:	None
Stop Bits:	1
Flow Control:	Hardware

Further information is given in Section A.

D. COMMUNICATING

In order to communicate with the DO7PLUS, the command "SYSTem:REMOte" must first be sent (see Section III.B). The commands detailed in Section III can then be used.

In order to return to local, manual mode, the command "SYSTem:LOCAl" should be sent (see Section III.B).

III. PROGRAMMING THE INTERFACE

A. INTRODUCTION

The interface is programmed in a common language which is based on SCPI (Standard Commands for Programmable Instruments). Although similar in style, full conformance to the SCPI and IEEE488.2 standards is not guaranteed.

The following is a brief guide to the structure and syntax of the programming language.

Command Tree

Commands are arranged as a hierarchical "tree", similar to the filing system trees found in personal computers. Commands start at the root level and progress down each level in more detail. The complete path must be specified to access the lower level commands.

Colon (:)

The colon is used to separate command keywords and automatically move the path down to the next level.

All new command lines automatically start at the root-level.

For the DO7PLUS, a colon must not be sent as the first character. This is treated as a non-recognised character.

Semicolon (;)

The semicolon is also used to separate command keywords, but in this case the path remains at the same level. This is to enable more than one command to be included in a single command line.

This is not implemented for the DO7PLUS, as only one command per line can be accepted. The semicolon is treated as a non-recognised character.

Whitespace (TAB or SPACE)

A whitespace character must be used to separate the first parameter from a command keyword.

The DO7PLUS will not accept whitespace characters in the subsequent parameter list.

Comma (,)

If a command requires multiple parameters, a comma must be used to separate parameters from one another in the parameter list.

Query (?)

Commands ending in a query (?) indicate that a response is expected from the instrument. This is usually a measured value or a parameter value. Commands sent without a query instruct the instrument to perform a function. The instrument will not output a response without a query command (except in Talk Only mode).

Common Commands (*)

Commands beginning with an asterisk (*) are called common commands and have a precise function as defined by the IEEE-488.2 standard. All instruments behave in an identical way. These commands are primarily concerned with control, reset, self-test and status.

Command Syntax

Most command keywords have both a long and short form. The bus controller can send commands in either form and also in any combination of upper and lower case characters. Instrument responses, however, are always in the short form, upper case.

If extra, redundant parameters are sent in a parameter list they are simply ignored. No error is produced.

e.g. SENSE:FRESistance:RANGe 60OHM,600OHM
{ignored}

In the description of commands that follows, various symbols are used for different features:

- < *parameter* > represents a field name.
- < ON|OFF > the vertical bar indicates OR
- [optional] square brackets indicate optional commands or parameters.
- "string" indicates an ASCII text string.

Data Types

The bus controller can also send data in a range of formats, but the instrument always responds in a precise format. There are four principal data types;

Numeric Parameters are decimal numbers which include an optional sign, mantissa, decimal point and exponent. Engineering suffix units are not accepted.

Discrete Parameters have limited values e.g. SINGle, INFinite, and like command keywords they can have long and short forms, upper and lower case.

Boolean Parameters have a single binary value. The controller can send OFF or 0, ON or 1, but the instrument response is always 0 or 1.

String Parameters contain text as ASCII characters.

Input Data Format

Numeric data sent to the instrument should be in Ohms or Degrees unless stated otherwise. The value can be in any standard scientific format.

e.g. 3kOhm can be sent as: 3000, 3E3, 3.000E+03, 0.3E4 etc.

The units are not sent.

Output Data Format

Non-Measurement queries	ASCII character string
Measurement queries	SDDDD.DDDDESDD <cr><lf>
Where	S = sign (+/-) D = decimal digit (0-9) E = Exponential <cr> = carriage return character <lf> = linefeed character

Measurement queries always return values expressed in Ohms or Degrees, and the units are omitted. Resistance values are returned with engineering exponents reflecting the resolution and units displayed on the instrument's display.

e.g. <u>Display</u>	<u>Returned Value</u>	
30.321 Ω	30.321	(60 Ω range)
2.9657 k Ω	2.9657E+03	(6k Ω range)
106.45 m Ω	106.45E-03	(600m Ω range)

If a query (?) command results in an error, then the IEEE488 error value of +9.90E+37 is sent to the output buffer.

Input Message Terminators

All messages sent to the instrument must terminate with either a <lf> character or a <cr> character. It is also permitted to send both <cr><lf> to terminate a message; the <lf> is ignored.

Message termination always forces the command path back to the root-level ready for the next command message.

Input Buffer

The instrument receives messages into an input buffer and only starts executing commands after receipt of a message terminator.

Sending a new command before the existing command is executed may cause unreliable operation.

Sending a command whilst the DO7PLUS is transmitting (following a ? command) may result in the transmitted response being corrupted. It is advisable to wait for the expected response to be transmitted before sending a new command.

B. REMOTE INTERFACE COMMANDS**SYSTem:REMOte**

Places the instrument in remote mode, so that the instrument will respond to other remote commands. All keys on the front panel are disabled.

SYSTem:LOCAl

Returns the instrument to the local (manual) mode from remote mode. All keys on the front panel are fully functional. The instrument will not respond to remote commands. This is the default at power-up.

C. CONFIGURATION COMMANDS

These commands allow the measurement configuration to be set up, but they do not trigger a measurement.

SENSe:FRESistance:RANGe <range>

Sets the resistance measurement range according to the following parameters:

<range>	6MOHM	(6 mOhm)
	60MOHM	(60 mOhm)
	600MOHM	(600 mOhm)
	6OHM	(6 Ohm)
	60OHM	(60 Ohm)
	600OHM	(600 Ohm)
	6KOHM	(6 kOhm)
	AUTO1	(Autorange1 - top range first)
	AUTO2	(Autorange2 - last-used range first)

SENSe:FRESistance:RANGe?

Returns the resistance range currently in force, together with the Autorange mode.

The response is an ASCII string of the form:

"<range>,<auto mode>"

where range = 6MOHM to 6KOHM (as in table above)
 auto mode = AUTO OFF, AUTO1, AUTO2

SOURce:CURRENT <current mode>

Sets the measuring current mode according to the following parameters:

<current mode> +I, -I, AVE, ZERO

Average mode cannot be set if the Settling Algorithm is on.

SOURce:CURRENT?

Returns the measuring current mode currently in force, using the appropriate parameter as above.

D. TRIGGER & MEASURE COMMANDS

These commands set the trigger mode, trigger measurements, and allow the results to be returned.

There are basically two methods of triggering a measurement:

INITiate (or *TRG) command:

This command triggers a measurement, but does not return the measurement result. The result can be obtained at any time with the FETCh? command.

READ? command:

This command triggers a measurement, and returns the measurement result as soon as it is available.

Effect of Single and Continuous triggering modes:

Datalog timer off:

If the instrument is set to Single trigger mode (INITiate:CONTInuous is set to OFF), then triggering a measurement by either the INITiate or READ? command will cause a single measurement to be made.

If the instrument is set to Continuous trigger mode (INITiate:CONTInuous is set to

ON), then triggering a measurement by either method will cause measurements to start, and to continue until one of the following occurs:

- The trigger mode is changed to Single.
- The Datalog is on and the required number of readings have been taken.
- The Datalog is on and is full.
- The ABORT command is sent.

Datalog timer on:

If the Datalog is on, and the delay timer is in operation (i.e. it is not set to 00:00:00), then the instrument operation is as follows:

If the instrument is set to Single trigger mode, then triggering a measurement by either

method will cause an immediate measurement to be made, and then a further measurement after each delay period until one of the following occurs:

- The required number of Datalog readings have been taken.
- The Datalog is full.
- The ABORT command is sent.

If the instrument is set to Continuous trigger mode, then the operation is the same as for Single trigger mode, except that the measuring current remains connected in between the measurements.

INITiate

This initiates a single measurement if in Single trigger mode, or continuous measurements if in Continuous trigger mode. The result is stored internally, but is not returned. Use FETCh? to return the result.

***TRG**

This is identical to the INITiate command

FETCh[:FRESistance]:TEMPerature]:TCOMPensate]?

Returns the value of the last measurement made. This is normally used in conjunction with the INITiate command. If in Single trigger mode, then INITiate followed by FETCh? will be needed for each measurement. If in Continuous trigger mode, then repeated FETCh? commands can be sent to return the most recent measurement.

One of three optional parameters can be included with this command:

FRESistance - Returns the uncompensated resistance, and is the default for the first FETCh?

TEMPerature - Returns the temperature value of the external Pt100 probe, providing that temperature compensation is "ON" and set to "Pt100" mode. Otherwise the error value is returned.

TCOMPensate - Returns the compensated resistance value at the reference temperature, providing that temperature compensation is "ON". Otherwise the error value is returned.

If no parameter is entered on subsequent FETCh? commands, then the parameter used in the previous FETCh? or READ? command is used.

For example, FETC:FRES?

will obtain the uncompensated resistance result from the last measurement.

READ[:FRESistance]:TEMPerature]:TCOMPensate]?

Triggers and returns a measurement. It is identical to INITiate, followed by FETCh?. See the FETCh? command for use of additional parameters.

This initiates a single measurement if in Single trigger mode, or continuous measurements if in Continuous trigger mode. The results are returned as soon as they are available.

This is true for basic operation, but see above if the Datalog Delay Timer is in use.

For example, READ:TCOM? will trigger a measurement, and return the temperature-compensated resistance result when the measurement is complete.

INITiate:CONTInuous <ON|OFF> or <1|0>

If set to OFF, then Single trigger mode is set, and any subsequent INITiate or READ? commands will trigger a single measurement.

If set to ON, then Continuous trigger mode is set, and any subsequent INITiate or READ? commands will trigger continuous measurements. The measurements can be stopped by setting INITiate:CONTInuous to OFF, or by sending the ABORT command.

This is true for basic operation, but see above if the Datalog Delay Timer is in use.

INITiate:CONTInuous?

Returns "0" (OFF) or "1" (ON).

TRIGger:MODE <MANual | AUTO>

Sets the auto trigger mode to manual or auto. If in auto, then measurements can be triggered simply by connecting the measurement leads to the test piece.

TRIGger:MODE?

Returns either "MAN" or "AUTO", according to the auto trigger state.

TRIGger:DELAy <hh>,<mm>,<ss>

Sets the Datalog timer, which adds a delay between measurements (max 23,59,59). The Datalog must be on. Note that if in Continuous trigger mode, then the measuring current remains connected during the delay, otherwise it is switched off between measurements.

TRIGger:DELAy?

Returns the Datalog timer delay value in the form "hh,mm,ss".

ABORT

Stops the current measurement.

E. DATALOG COMMANDS

These commands control the Datalog memory, and allow stored readings to be retrieved.

MEMory:DATA:CLEAR

Clears the Datalog memory. Take care; all the currently stored values will be lost!

MEMory:DATA:COUNT <No. of readings>

Sets the number of readings to be stored. Valid range is 1 to 1000. This is used in Continuous trigger mode in order to allow the instrument to take the specified number of readings, and then stop. If in Single trigger mode, then it is of limited use, unless the delay timer is in operation (see Section D), in which case, it can again be used to take the specified number of readings with delays between each, and then stop.

MEMory:DATA:COUNT?

Returns the number of readings to be stored.

MEMory:DATA:STATe <ON|OFF> or <1|0>

Enables or disables the Datalog function. When turned on, all readings are sent to the Datalog memory. *Note that if the delay timer is set (i.e. if it is not 00,00,00), then this will operate when the Datalog is turned on.*

MEMory:DATA:STATe?

Returns "0" (OFF) or "1" (ON).

MEMory:DATA? <first Datalog entry number[,last Datalog entry number] | ALL>

Returns Datalog readings from the memory.

"MEM:DATA? 56" will return reading number 56.

"MEM:DATA? 56,78" will return all the readings from number 56 to 78 inclusive.

"MEM:DATA? ALL" will return all readings sequentially from location 1 to the end of the Datalog (POINTS). The output format is:

<record no.>,<range>,<resistance>,<date>,<time>,<notes>

The "range" will include the letter 'T' if Temperature Compensation was used, for example:

"56,6KOHM T,1.2345E+03,24.04.08,10:25:35,Test No. 56789".

MEMory:DATA:POINTs?

Returns the number of readings actually stored in the Datalog memory.

CALCULATE:DATA GROUP

These commands perform statistical calculations on the contents of the Datalog. A minimum of 2 readings must be stored, otherwise the error value is returned. The error value is also returned if the log contains inconsistent entries, e.g. readings taken on different ranges, or a mixture of temperature-compensated and non-temperature-compensated readings. The calculation can be on the entire Datalog, or on a selected range of readings.

CALCulate:DATA:MINimum? <first Datalog entry number,last number | ALL>

Returns the minimum resistance value stored in the data log.

CALCulate:DATA:MAXimum? <first Datalog entry number,last number | ALL>

Returns the maximum resistance value stored in the data log.

CALCulate:DATA:AVERage? <first Datalog entry number,last number | ALL>

Returns the average of the resistance values stored in the data log.

CALCulate:DATA:PTPeak? <first Datalog entry number,last number | ALL>

Returns the peak-to-peak value of the resistance values stored in the data log, i.e. max to min.

CALCulate:DATA:SDEVIation? <first Datalog entry number,last number | ALL>

Returns the standard deviation of the resistance values stored in the data log. This is effectively a measure of rms noise.

For example:

"CALC:DATA:AVER? 56,78" will return the average of the Datalog readings from entry number 56 to 78 inclusive.

"CALC:DATA:AVER? ALL" will return the average of all of the readings in the Datalog.

F. TEMPERATURE COMPENSATION COMMANDS

These commands are used to control the Temperature Compensation function.

SENSe:TCOMPensate:STATe <ON|OFF> or <1|0>

Enables or disables the temperature compensation function.

SENSe:TCOMpensate:STATe?

Returns "0" (OFF) or "1" (ON).

SENSe:TCOMpensate:MODE <EXT> or <MAN,manual temperature>

Sets the temperature of the test-piece to either an external Pt100 probe measurement, or to a fixed, manually-entered temperature, the unit of which is the current temperature unit (°C or °F). Range is 0 - 100 °C (32 - 212°F)

SENSe:TCOMpensate:MODE?

Returns "EXT", or "MAN",<manual temperature>.

SENSe:TCOMpensate:REfERENCE <temperature value>

Sets the reference temperature. This is the temperature to which resistance measurements are compensated (normally 20°C). It is entered in the current temperature unit (°C or °F). Range is 0 - 50°C (32 - 122°F).

SENSe:TCOMpensate:REfERENCE?

Returns the reference temperature in the current temperature unit.

SENSe:TCOMpensate:COEfficient <CU|AL> or <USER1 | USER2[,user coefficient]>

Sets the temperature coefficient to Copper, Aluminium or to one of two user-defined values. For USER1 and USER2, the user coefficient is optional, and if omitted, will remain at the existing value. If it is entered, the value must be in ppm/°C (0 - 9999).

For example: "SENS:TCOM:COEF USER2,4100" sets the coefficient to USER2, which is given a value of 4100 ppm/°C.

SENSe:TCOMpensate:COEfficient?

Returns "CU",<fixed copper coefficient>, or "AL",<fixed aluminium coefficient>, or "USER1",<user1 coefficient>, or "USER2",<user2 coefficient>. The coefficients are quoted in ppm/°C.

SENSe:TEMPerature:UNIT <C|F>

Sets the temperature unit to °Celsius or °Fahrenheit.

SENSe:TEMPerature:UNIT?

Returns "C" or "F".

G. MEASUREMENT LIMIT COMMANDS

These commands are used to set and query the lower and upper measurement limit values.

CALCulate:LIMit:LOWer <value>

Sets the lower measurement limit. The value is in Ohms (0 - 6000).

CALCulate:LIMit:LOWer?

Returns the lower measurement limit in Ohms.

CALCulate:LIMit:UPPer <value>

Sets the upper measurement limit. The value is in Ohms (0 - 6000).

CALCulate:LIMit:UPPer?

Returns the upper measurement limit in Ohms.

CALCulate:LIMit:STATe <ON|OFF> or <1|0>

Enables or disables the measurement limit function.

CALCulate:LIMit:STATe?

Returns "0" (OFF) or "1" (ON).

H. FILTER (ROLLING AVERAGE) COMMANDS

These commands are used to control the Filter function.

SENSe:AVERAge:STATe <ON|OFF> or <1|0>
Enables or disables the filter (rolling average) function.

SENSe:AVERAge:STATe?
Returns "0" (OFF) or "1" (ON).

SENSe:AVERAge:COUNT <No. of readings>
Sets the number of readings to be filtered or averaged (2 - 50).

SENSe:AVERAge:COUNT?
Returns the number of readings to be filtered (averaged).

Selecting the Filter will automatically deselect the Settling Algorithm.

I. SETTLING ALGORITHM COMMANDS

These commands are used to control the Settling Algorithm.

SENSe:SETTLing:STATe <ON|OFF> or <1|0>
Enables or disables the Settling function.

SENSe:SETTLing:STATe?
Returns "0" (OFF) or "1" (ON).

SENSe:SETTLing:COUNT <No. of readings>
Sets the maximum number of readings to be taken (2 - 999).

SENSe:SETTLing:COUNT?
Returns the maximum number of readings selected.

SENSe:SETTLing:LIMit <No. of digits>
Sets the maximum number of display digits (1 - 999) by which two consecutive readings may differ, for the measurement to be defined as 'settled'.

SENSe:SETTLing:LIMit?
Returns the maximum number of display digits selected.

Selecting the Settling Algorithm will:

Deselect the Filter function.

Change Average (AVE) Current mode to Positive (+) Current mode.

Selecting Filter on will automatically deselect the Settling Algorithm.

If the Settling Algorithm is on, Average (AVE) current cannot be selected.

J. SYSTEM RELATED COMMANDS**SYSTem:REMOte**

Places the instrument in remote mode (see Section B).

SYSTem:LOCal

Returns the instrument to the local (manual) mode from remote mode (see Section B).

SYSTem:BEEPer

Issues a single beep.

SYSTem:BEEPer:STATe <ON|OFF> or <1|0>

Enables or disables the front-panel beeper.

SYSTem:BEEPer:STATe?

Returns "0" (OFF) or "1" (ON).

SYSTem:VERSion?

Queries the SCPI version to which the instrument conforms.

The DO7PLUS does not conform in every way, and therefore returns the message "NOT SCPI COMPLIANT".

SYSTem:TIME <hh>,<mm>,<ss>

Sets the system clock time in 24 hour clock format.

SYSTem:TIME?

Queries the system clock time. Returns "<hh>,<mm>,<ss>" in 24 hour clock format.

SYSTem:DATE <yyyy>,<mm>,<dd>

Sets the system calendar date.

SYSTem:DATE?

Queries the system calendar date. Returns "<yyyy>,<mm>,<dd>".

SYSTem:DATE:FORMat "DD:MM:YY" or "MM:DD:YY"

Sets the date format (for the Datalog output, for example).

SYSTem:DATE:FORMat?

Queries the date format. Returns "DD:MM:YY" or "MM:DD:YY".

DISPlay:BRIGhtness <ON|OFF> or <1|0> or <AUTO[,<delay value>]

Turns the front-panel display backlight on or off, or to an Auto setting, which turns the backlight off after the DO7PLUS has been idle for the delay value in seconds. The delay value is optional, and if omitted, will remain at the existing value.

DISPlay:BRIGhtness?

Returns "0" (OFF) or "1" (ON) or "AUTO,<delay value>".

***IDN?**

Read the instrument's identification string. This is of the form:

"<manufacturer>,<model no.>,<serial no.>,<software version>"

e.g. "Cropico, DO7PLUS, K12-3456, Ver1.0"

***RST**

Resets the instrument to the default RESET condition as described below, and places the measurement in Standby mode.

Range	6kOhm Range
Autorange	AUTO1 (Top range first)
Current mode	+I (Positive current)
Trigger mode	Single trigger measurements
Auto trigger mode	Off
Limits	Off
Datalog	Off
Temperature Compensation	Off
Filter	Off
Settling Algorithm	Off
Cable mode	Off

All other functions and parameters are left unchanged by *RST.

***TST?**

Always returns '0' to indicate self-test OK.

***WAI**

This command is accepted, but ignored as all commands are executed sequentially. It is provided only for compatibility with IEEE-488.2.

APPENDIX I**REMOTE COMMAND SUMMARY****Configuration Commands**

SENSe:
 FRESistance:RANGe <range>
 FRESistance:RANGe?
 SOURce:CURRent <current mode>
 SOURce:CURRent?

Trigger & Measure Commands

INITiate
 *TRG
 FETCh[:FRESistance]:TEMPerature[:TCOMPensate]
 READ[:FRESistance]:TEMPerature[:TCOMPensate]?

INITiate:CONTInuous <ON|OFF> or <1|0>
 INITiate:CONTInuous?

TRIGger:MODE <MANual | AUTO>
 TRIGger:MODE?
 TRIGger:DELAy <hh>, <mm>, <ss>
 TRIGger:DELAy?

ABORt

DataLog Commands

MEMory:
 DATA:CLEAr
 DATA:COUNT <No. of readings>
 DATA:COUNT?
 DATA:STATe <ON|OFF> or <1|0>
 DATA:STATe?
 DATA? <first Datalog entry number[,last Datalog entry number] | ALL>
 DATA:POINTs?

CALCulate:
 DATA:MINimum?
 DATA:MAXimum?
 DATA:AVERage?
 DATA:PTPeak?
 DATA:SDEVIation?

Temperature Compensation Commands

SENSe:TCOMPensate:
 STATe <ON|OFF> or <1|0>
 STATe?
 MODE <EXT> or <MAN,manual temperature>
 MODE?
 REFerence <temperature value>
 REFerence?
 COEFFicient <CU|AL> or <USER1 | USER2[,user coefficient]>
 COEFFicient?

SENSe:TEMPerature:
 UNIT <C|F>
 UNIT?

Measurement Limit Commands

CALCulate:LIMit:
LOWer <value>
LOWer?
UPPer <value>
UPPer?
STATe <ON|OFF> or <1|0>
STATe?

Filter (Averaging) Commands

SENSe:AVERage:
STATe <ON|OFF> or <1|0>
STATe?
COUNT <No. of readings>
COUNT?

Settling Algorithm Commands

SENSe:SETTling:
STATe <ON|OFF> or <1|0>
STATe?
COUNT <No. of readings>
COUNT?
LIMit <No. of digits>
LIMit?

System Related Commands

SYSTem:
REMote
LOCal
BEEPer
BEEPer:STATe <ON|OFF> or <1|0>
BEEPer:STATe?
VERSion?
TIME <hh>,<mm>,<ss>
TIME?
DATE <yyyy>,<mm>,<dd>
DATE?
DATE:FORMat "DD:MM:YY" or "MM:DD:YY"
DATE:FORMat?

DISPlay:BRIGhtness <ON|OFF> or <1|0> or <AUTO[,delay value]>
DISPlay:BRIGhtness?s

*IDN?
*RST
*TST?
*WAI

APPENDIX II**RS-232 Pin Connections**

1		Remote Start	(input)
2	RXD	Received Data	(input)
3	TXD	Transmitted Data	(output)
4			(not connected)
5	GND	Signal Ground	
6			(not connected)
7	RTS	Request To Send	(output)
8	CTS	Clear To Send	(input)

For Technical Support Contact:

Tel: +44 (0) 191 587 8718

For Service and Calibration Contact:

Service Department
Seaward Group
Unit 11
Bracken Hill
South West Industrial Estate
Peterlee
Co Durham
SR8 2LS
England

Tel: +44 (0) 191 587 8739

Fax: +44 (0) 191 587 8737

E-mail: service@seaward.co.uk

CROPICO is a division of



Additional Products From Cropico

DIGITAL OHMMETERS

RESISTANCE BRIDGES

RESISTANCE DECADE BOXES

RESISTANCE STANDARDS

DIGITAL THERMOMETERS

THERMOCOUPLE SIMULATORS

PT100 SIMULATORS

INSULATION TEST SETS

UNIVERSAL CALIBRATORS

HIPOT TESTERS

ELECTRICAL SAFETY TESTERS



Phone, fax or e-mail for further information on the above or for a copy of our general catalogue: - Phone: - +44 (0) 191 5863511

Fax: - +44 (0) 191 5860227

E-mail:- sales@cropico.com

Website: - www.cropico.com

