

P/N: MR07

Copyright

© 2015, FLIR Systems, Inc.

All rights reserved worldwide. Names and marks appearing herein are either registered trademarks or trademarks of FLIR Systems and/or its subsidiaries. All other trademarks, trade names or company names referenced herein are used for identification only and are the property of their respective owners.

Document identity

Publ. No.: MR07

Release:

Commit: 30134

Language: en-US

Modified: 2015-10-31

Formatted: 2015-11-02

Website

<http://www.flir.com>

Customer support

<http://support.flir.com>

Disclaimer

Specifications subject to change without further notice. Camera models and accessories subject to regional market considerations. License procedures may apply. Products described herein may be subject to US Export Regulations. Please refer to exportquestions@flir.com with any questions.



General description	
Part number	MR07
Part name	Hammer Probe
<p>The FLIR MR07 Hammer Probe expands the functionality of your FLIR moisture meter by allowing you to take measurements in the subfloor through carpet, hardwood flooring, and hard materials that are difficult to penetrate with a standard pin probe.</p> <p>FLIR's new insulated pins are smaller in diameter—requiring minimal force to drive the pins into a surface—resulting in less impact to the material. The sandblasted, hardened-steel pins with a single-piece design prevent bending and create an improved bonding surface for the abrasion-resistant insulation. The insulation extends all the way to the connection to the probe, so even if you drive the pins all the way into the wall cavity, the drywall will not affect the measurement.</p> <ul style="list-style-type: none"> • Insulated pins designed for increased durability. • Rubberized ergonomic grips reduce slippage. • Detachable cord with durable BNC connection. • Pins included: 2 pairs of 2 in. pins. 	
Meter data	
Suitable main unit	MR77, MR160, MR176
Cable length	2.45 m (8 ft.) uncoiled
Included insulated pin pairs and length	2 pairs of 2 in. (50 mm)
Warranty	2 years (with registration)
Meter physical data	
Weight:	1.22 kg (1.10 lbs.)
Dimensions (H x W x L)	4.5 cm x 5.97 cm x 45.4 cm (1.8 in. x 2.4 in. x 17.9 in.)
Material	PC-ABS, stainless steel
Color	Black
Shipping information	
Packaging type	White box with accessory color printing
Packaging contents	MR07, 2 sets of 2 in. insulated pins, pin wrench, shoulder case
Packaging weight	5 kg (11.1 lb.)
Packaging dimensions (H x W x L)	15.5 cm x 18 cm x 65 cm (6.1 in. x 7.1 in. x 25.6 in.)
Master carton weight	11 kg (24.25 lb.)
Master carton dimensions (H x W x L)	18.5 cm x 36.5 cm x 67 cm (7.3 in. x 14.4 in. x 26.4 in.)
Master carton quantity	2
EAN-13	0793950370070



Hammer Probe

P/N: MR07

© 2015, FLIR Systems, Inc.

#MR07; r. /30134; en-US

Shipping information	
UPC-12	793950370070
Country of origin	China
Tariff code	9025900000

Technical support	
Website	http://support.flir.com
E-mail	TMsupport@flir.com
Phone	855-499-3662
Repairs	repair@flir.com

Replacement parts	
MR-PINS2	2 inch pins for MR06, MR07, MR08, includes 1 pair of pins
MR-PINS2-10	2 inch pins for MR06, MR07, MR08, includes 10 pairs of pins
MR-PINS4	4 inch pins for MR06, MR07, MR08, includes 1 pair of pins
MR-PINS6	6 inch pins for MR06, MR07, MR08, includes 1 pair of pins

© 2015, FLIR Systems, Inc. All rights reserved worldwide. No part of this drawing may be reproduced, stored in a retrieval system, or transmitted in any form, or by any means, electronic, mechanical, photocopying, recording, or otherwise, without written permission from FLIR Systems, Inc. Specifications subject to change without further notice. Dimensional data is based on nominal values. Products may be subject to regional market considerations. License procedures may apply. Product may be subject to US Export Regulations. Please refer to exportquestions@flir.com with any questions. Diversion contrary to US law is prohibited.

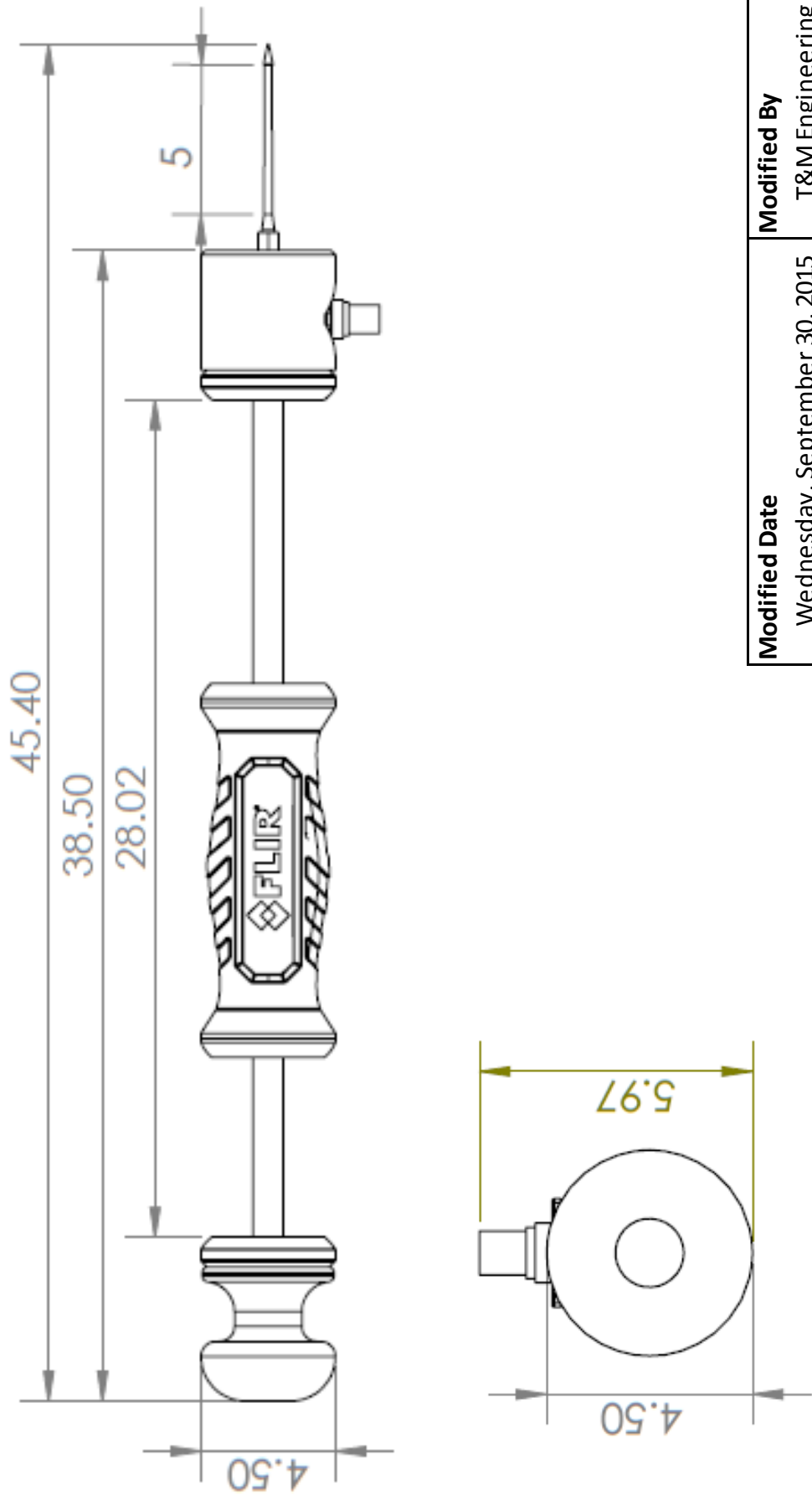

Modified Date Wednesday, September 30, 2015	Modified By T&M Engineering
Description FLIR MR07 Hammer Probe	
Units Centimeters	Scale Not to Scale