Gasman

Personal Single Gas Monitor



User Manual

M07630

Sep 2015
Issue 11

**CROWCON**
Detecting Gas Saving Lives

Instructions specific for use in hazardous areas

The following instructions apply to equipment covered by certificate number:

Baseefa04ATEX0383 Flammable Gas

IECEx BAS 05.0038 Flammable Gas

Baseefa04ATEX0384 Oxygen or Toxic Gas

IECEx BAS 05.0039 Oxygen or Toxic Gas

The following information covers all relevant points listed in clause 1.0.6 of the EHSR's of the ATEX directive.

The certification marking is as follows:

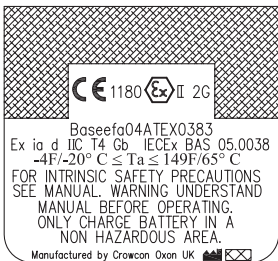
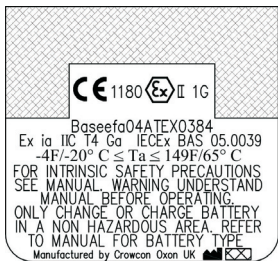

1. The equipment may be used in Zones 1 and 2 for flammable versions and Zones 0, 1, and 2 for toxic and oxygen versions, for Group IIA, IIB, and IIC gases and vapours for Temperature Classes T1, T2, T3 and T4
2. The equipment is certified for use in ambient temperatures in the range -20°C

to $+65^{\circ}\text{C}$ (-4 to $+149$ F). The equipment should not be used outside these ranges.

3. Compliance with the Essential Health and Safety Requirements has been assured by compliance with EN60079-0:2004 + Amds 1 & 2, EN60079-1:2004 and EN60079-11:2006, as certified by Baseefa.
Compliance with gas detection performance standards EN50054, EN50057, EN61779-1, EN50104 and EN50270 has been certified by Lloyd's Register
4. Repair of this equipment and gas sensor replacement shall be carried out by the manufacturer or in accordance with the procedures in the manual and by trained personnel.
5. If the equipment is likely to come into contact with aggressive substances, then it is the responsibility of the user to take suitable precautions that prevent it from being adversely affected, which may compromise the certification level.
6. The rechargeable battery must only be charged in non-hazardous (safe) areas by connection to the specified Crowcon charger.
7. Only the following cell types may be fitted in the battery compartment of the non-rechargeable battery pack: CR2 of the following brands only: Panasonic, GP, Energiser and Maxell. Do not fit a Duracell battery.
The cells must only be changed in a non-hazardous (safe) area.
8. The equipment is not certified for use in atmospheres containing more than 21% oxygen.

From the 1st November 2010, EN60079-29 part 1 has been harmonised under the ATEX directive 94/9/EC. Therefore to comply with the ATEX directive, portable apparatus sensing flammable gases should have a functional check with gas before each day of use. Other testing regimes may be employed depending on local circumstances.

Area Classifications: -

Zone 0: An area classified as Zone 0 is an area in which an explosive mixture of gas is continuously present or present for long periods.

Zone 1: An area classified as Zone 1 is likely to have ignitable concentrations of flammable gases, vapours or liquids present under normal operating conditions.

Zone 2: An area classified as Zone 2 is not likely to have ignitable concentrations of flammable gases, vapours or liquids present under normal operating conditions.

© Copyright Crowcon Detection Instruments Ltd 2015.

All rights are reserved. No part of the document may be photocopied, reproduced, or translated to another language without the prior written consent of Crowcon Detection Instruments Ltd.

Safety information:

- Read and understand all instructions in the operation section of this manual before use.
- Do not substitute components as this may impair intrinsic safety and invalidate warranty.
- Observe all warnings and instructions marked on the unit and within this manual.
- Observe site health and safety procedures for gases being monitored and evacuation procedures.
- Understand the screen display and alarm warnings prior to use.
- If this product is not working properly, read the troubleshooting guide or contact your local Crowcon Office or agent..
- Ensure qualified service personnel change sensors and operating system.
- Ensure maintenance , service and calibration are carried out in accordance with the procedures in the manual and by trained personnel.

Gasman

Personal Single Gas Monitor

Contents

Unpacking	1
I. Introduction	7
II. Operation	9
III. Batteries	14
IV. Alarm indications	16
V. Fixing Accessories	18
VI. Flow sampling	19
VII. Maintenance and Calibration	23
VIII. PC interface and software	26
IX. i-module replacement	28
X. Specification	30
XI. Accessories and spare parts	31
XII. Troubleshooting guide	34
Appendix: Limitations of sensors.	35

Gasman

Personal Single Gas Monitor

Thank you for purchasing the new Gasman Personal Gas Monitor. Gasman has redefined portable gas monitoring and will give you years of unparalleled service and reliability.

Please read the instructions carefully before use. Keep the manual for future reference.

Unpacking

Remove the Gasman Personal Gas Monitor from the packaging. The Gasman accessories will be located in the bottom of the box. Check the contents are complete, you should have:

- Gasman unit with alligator pocket clip;
- A configuration report detailing the sensor installed, alarm settings and a calibration certificate;
- Calibration flow cap and tubing;
- User manual.

Optional battery chargers and other accessories will be packed in a separate box.

Battery check

The Gasman Personal Gas Monitor has two battery options: Li-ion rechargeable or non-rechargeable batteries. The label on the back of the detector will have either NR (non-rechargeable) or R (rechargeable) to indicate which battery option is within the detector.

Rechargeable units

Gasman uses a Li-ion battery pack and should arrive with sufficient charge so that the unit can be used straight out the box. However, if this is the first time you have used the Gasman unit, you may need to charge the battery to attain the full operating time. (The actual operating time will depend on the types of sensor installed.) The flammable Gasman will operate for at least 12 hours on a fully charged battery.

Warning: rechargeable units

Only charge the rechargeable Gasman Personal Monitor with a Crowcon Gasman charger. Failure to comply could invalidate safety certification, warranty and safety; and may result in permanent damage to the unit.

Non-rechargeable units.

Gasman uses a CR2 battery which can be easily field replaced. Ensure only the correct types of battery are fitted to maintain compliance with certification (see Battery check on page 1).

Gasman IR CO₂ Personal Single Gas Monitor

The Gasman IR CO₂ personal single gas monitor an infrared gas sensor for CO₂ detection. This version of Gasman is not designed or certified for use in a hazardous area, and the safety certification data in Section X is not applicable. Operation and maintenance of the Gasman IR CO₂ is essentially the same as for other Gasman units but with the following points to note.

CO₂ is present in ambient air at a background concentration of just under 400ppm (0.04%). In any enclosed environment the ambient CO₂ concentration will increase as a result of respiration and if the room is poorly ventilated concentrations well in excess of 1000ppm (0.1%) can occur. CO₂ levels in the outdoor air will also be enhanced by any emitted CO₂ e.g. from vehicle exhausts or boiler flues venting to atmosphere so it is normal to see fluctuating levels of CO₂ on the display whether indoors or outside.

Quickstart guide

1. Getting started

Gasman familiarisation

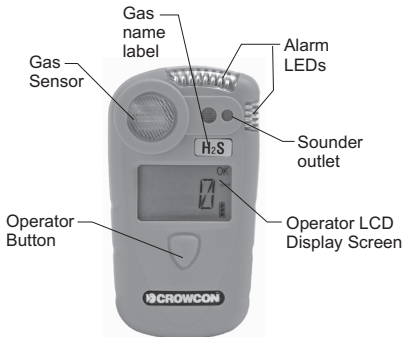

Switching on

Gasman requires little setting up. Follow these simple steps to get your unit ready for use.

- 1. Ensure the unit is in clean air.**
2. Switch on. Press and hold the operator button for approximately 3 seconds until the red LEDs flash.

The operator display screen will light up and the unit will begin a warm up sequence.

The user should now check the detector goes through the warm up sequence detailed below. In the case of any deviations the Gasman should be returned to your local Crowcon office or Service agent.

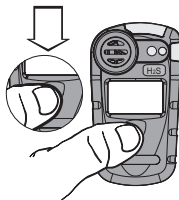

Gasman warm up sequence

- a) The Gasman will demonstrate the alarm LEDs, sounder, vibration alerts, and the operator display screen. The sounder may be silenced by pressing the button.



The Gasman screen will show the following display during the warm up sequence. This will take approximately 20 seconds.

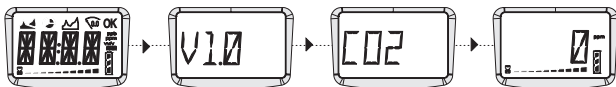

Note: these screens may differ depending on what sensor is being used.

- b) Autozero

If Autozero is enabled (default), the unit will display the Autozero confirm screen: the display will alternate between 'ZERO' and '????'. Press the operator button with a single click to confirm Zero. If the operator button is not pressed within the 10 second time out, Gasman will proceed directly to Run mode without performing Zero.

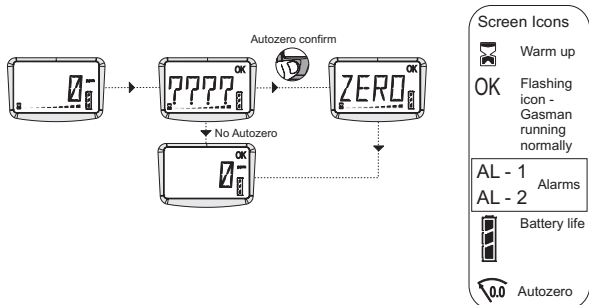

Confidence signals

In normal Run mode, Gasman will emit a short beep accompanied by a blue LED flash every 10 seconds and the OK icon flashes to show operational health. These confidence signals can be disabled using the PC software.

2. In the event of an alarm**Alarm signals**

In the event of gas concentrations exceeding the alarm thresholds for the gas being monitored, Gasman will activate the alarm signals.

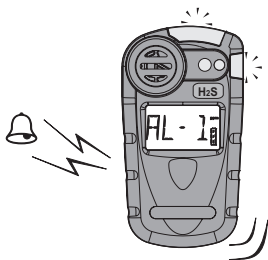
**Alarm signals**

The red and blue alarm LEDs will flash, the sounder will emit a loud, fast series of beeps, the internal vibrator alarm will activate. The operator screen will display the alarm level and gas reading alternately.

See the figure to the left.

AL - 1 — Alarm level one

AL - 2 — Alarm level two

1. When the gas level returns to normal, press the operator button. This will reset your Gasman unit to normal Run mode. If the gas level is still within alarm limits, the button will have no effect.

The Gasman alarm is set to latch by default. The unit will still continue in alarm mode even when the gas level returns to normal, until the button is pressed and the alarm is cleared.

3. Switch off unit and storage**Switching off**

1. Press and hold the button for 5 seconds until the display shows OFF. The display will count down to switch off.

Storing conditions

In order to optimise sensor performance and lifetime, your Gasman unit should be stored in a safe, non-hazardous area, at 0-20°C and 20-90% RH.

4. Additional information

For battery recharging information go to section III.

For fixing accessories go to section V.

For sampling section go to section VI.

For calibration information go to section VII.

For troubleshooting guide go to section XII.

I. Introduction

Thank you for purchasing the new Gasman Personal Single Monitor. Gasman is a portable Single Gas detector, designed to be carried or worn by individuals working in hazardous environments such as confined spaces. It is suitable for use in classified hazardous areas. Gasman monitors a single gas and displays its reading on a display screen. Alarm warnings are given through a combination of a loud audible alarm, a bright visual alarm of blue/red flashing LEDs and an internal vibrator. Gasman can be fitted with a wide range of modular, or plug and play gas sensors. The sensor carries an intelligent processor which contains calibration and sensor information.

Gasman is battery operated and is available with rechargeable batteries or dry cell battery options. The dry cell battery option is only available for toxics and oxygen Gasman units. A battery charger for single and multiple Gasman units is available for rechargeable units, see section XI for more information.

At Crowcon we recognised the need for a reliable and robust personal monitoring system, which is both small, light and easy to use. Gasman has a single operator button, and an intelligent user-friendly display with automatic backlight. The gas level is continuously monitored providing normal gas readings, peak readings and time weighted averages (TWA). Gasman is available as a diffusion sampling instrument, see section XI for sampling accessories. Configuration and data/event logging is handled by Crowcon Portables PC software, the PC communication link is provided as a link on the charger interface unit.

Gasman's compact shape and design makes it comfortable to wear, with a non-slip grip for better handling. Extra accessories such as pocket clip, hard hat clip, shoulder strap and chest harness, can be purchased.

Gasman has been designed from top to bottom to bring you a lighter, compact design with single button operation for ease of use, maintenance and extreme reliability.

i-module gas sensor

Gasman uses unique plug and play i-module sensor technology. Each sensor unit incorporates its own intelligent processor holding sensor configuration and calibration data. Different sensors can be purchased, and once inserted, are immediately ready to run. Flammable units are only available with rechargeable batteries. Plug and play will ease maintenance time and cost, and the intelligent modular system will remove the need to calibrate the sensor. Gasman can be reconfigured by purchasing additional pre-calibrated i-modules from Crowcon or your local office. After fitting a new i-module, it is recommended that a gas test is carried out on the detector before use.

Reliable, anti-shock mechanics and robust housing

The Gasman housing is built from resilient material, giving it strength and flexibility to withstand the hardest of working conditions, water and dust tight to IP65 with a non-slip grip. If the unit is dropped, there will be no disruption of power or function, ensuring reliability and service for years to come.

Software

The internal software in Gasman has been designed and written in accordance with the requirement of IEC 61508 to ensure quality and integrity of operation. Gasman has been designed to give a truly reliable personal gas monitoring system. The internal circuitry includes an independent watchdog. The software monitors for any malfunction within the unit and will display an error warning to the user should they occur.

II. Operation

2.1 Switch-on sequence

1. Ensure the unit is in clean air.

NB. For CO₂ detectors see zeroing, Section VII.

2. Switch on

Press and hold the operator button for approximately 3 seconds until the red LEDs flash.

The instrument begins with testing all the LCD segments on the operator display screen, the red and blue alarm LEDs, sounder and internal vibrator alert. The sounder may be silenced by pressing the button. The unit enters a warm up mode and displays a sequence of screens, see page 3 for more details. At the end of warm up, the Autozero menu will be displayed.

The Autozero function can be disabled or set to run automatically, without user confirmation: Autozero will not appear. See section VIII PC Interface and software.



Battery check

Use this time to check there is sufficient charge in the battery pack

Calibration check

During the warm up sequence, if the next calibration date is due in less than 31 days, 'CAL - nn' will be displayed (where nn is the number of days to the next calibration). If calibration is already overdue, the Gasman unit will display a warning message 'CAL'. The instrument can still function, but it is strongly recommended the unit is sent for calibration as soon as possible.

Press the button to continue to Run mode.

The Gasman can be set, using Portables PC software, to lock out in the event of the calibration due date expiration in order to prevent further operation of the detector until a calibration is performed.

3. Autozero

Press the operator button with a single click to confirm Autozero. Flammable and toxic units will be set to read zero and oxygen units set to read 20.9%. If the operator button is not pressed within 10 seconds Gasman will proceed directly to normal operation without performing a zero.

NB. If Autozero fails, a warning message will be displayed.

Switch off

To switch off the unit, press and hold the operator button for 5 seconds. The display will count down from 5 until the unit counts down to shut off.

2.2 Run mode

The Gasman unit displays the gas reading on the operator display screen. A typical display is shown below:

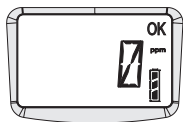

The sensor channel will display the current value of the gas being monitored and the unit of measurement, the 'OK' symbol will flash indicating unit is working correctly. Familiarise yourself with the gas being monitored in your unit. Ensure you understand site health and safety procedures. For information on Peak and TWA readings, go to section 2.4.

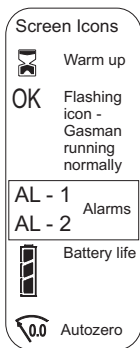

Confidence signals

To reassure users the unit is working correctly, the Gasman unit will emit a short confidence beep accompanied by a blue LED flash every 10 seconds and the OK icon will flash continuously.

2.3 Display symbol guide

Battery



A full battery is represented by a battery icon showing full three bars. A low battery charge will show 1 bar. When zero bars are shown the battery icon flashes and the sounder will emit warning beeps.

If the battery becomes too low for operation the Gasman will switch off. A low battery warning will alarm prior to switch off.

TWA alarm

Gasman will display the TWA alarm for toxic gases when the 15 minute or 8 hour Time Weighted Average alarm threshold is passed.

Gasman will display 'LTWA' and 'STWA'. When a TWA alarm threshold is reached the TWA alarm cannot be cleared.

2.4 Display options

Gasman provides four additional selectable displays:



Peak display

When Peak mode is selected the instrument shows the highest value for flammable and toxic gases, or the lowest value for oxygen since switch on or last Peak Reset. This is useful for vertical entry checks where the Gasman can be lowered down the shaft rather than using a sampling tube and for viewing peak exposure at the end of a shift.



TWA display

Shows the 15 minute and 8 hour TWA, for toxic gases, monitored since last turn on.



Peak Reset

Before a Peak entry test is performed select this menu option to clear any previously stored Peak value.



Zero

Performs Zero on your Gasman unit. (Please ensure you are in clean air).

How to display the menu

- To view the additional display option menu, double-click the button. The menu icons will appear on the screen, as shown below.

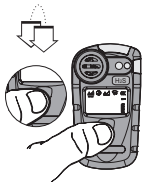

Note: Only toxic gas monitoring units will display the TWA menu option.

- Press the operator button with a single click to scroll across the list. When the underscore appears under your choice, double-click the operator button. This will select the option. If Peak or TWA is selected, Gasman will display the icon on the operator screen.

Peak test

When performing a Peak test, such as a vertical entry check, previous readings can be cleared by selecting the Peak Reset menu option  .

1. Scroll menus

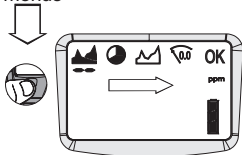

2. Select

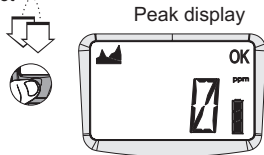

Zero

To perform Autozero, select the Zero function from the menu.

When Zero is completed, the instrument will return to normal Run mode.

3. Run mode

The Gasman is now ready to use.

Familiarise yourself with the gas being monitored in your unit and make sure you understand site health and safety procedures in the event of alarm conditions.

2.5 Logging

Gasman incorporates both data and event logging which can be accessed using the RS232 communications link available with the *Single Way Charger Interface* (part No.CO1940), using Crowcon Portables PC software. See section VIII.

Data is recorded every minute (this rate can be adjusted using the PC software). The log can record 900 hours of data at 1-minute intervals.

Gasman also records the time and date for a number of operating and diagnostic events including:

- Switch on and switch off;
- Level 1, Level 2 and TWA, alarm on, alarm off and the peak level during the alarm;
- Zero, calibration and gas test with success or failure;
- Flammable sensor saver on and off;
- The battery condition is logged every switch on and switch off while the instrument is operating, and certain configuration changes are also logged;
- The Event log can record over 4800 events.

III. Batteries

3.1 Rechargeable batteries

Recharge time for the Li-ion batteries is less than 6 hours (less, if they are not fully discharged). Rechargeable batteries will typically last 12+ hours for flammable units.

3.2 Gasman Charging Unit

There are 3 models of charging units available for Gasman; a single way drop in charger unit, a single way charger unit with integral PC Interface, and a multiway charger unit. The multiway charger unit can accommodate up to 5 Gasman units. Note: the multiway charger unit does not have a PC interface option.

The charger units are powered by a nominal 12 V dc input. Power Supplies are available with UK, EUR or US pins, alternately a universal 90-260 V power supply is available for any other configuration. The multiway charger includes a universal power supply. A vehicle lighter socket lead can also be supplied, please see section XI Parts and Accessories.

Communications and charging are only permitted via Crowcon charger/charger-interface C01940.

Charging the batteries

1. Ensure you are in a safe area.

2. Plug the charger power supply into a mains socket, and connect to the charger lead.

3. To charge your Gasman, simply drop the Gasman into the charger in an upright position with the screen facing outwards, see diagram below:

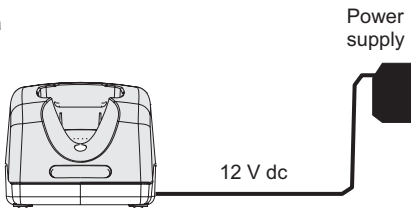

The Gasman should normally be switched off for charging. During charging the red LED on the front of the charger unit will be lit. When charging is complete the red LED is extinguished.

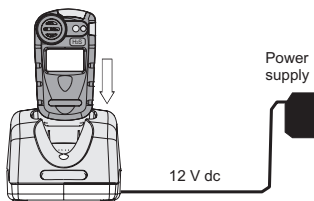

During charging, the display will show the battery icon sweeping from empty to full. On removing Gasman from the charger unit, if the Gasman is on, the display icon will update in 20 seconds to show actual charge state.

Chargers with dual LEDs are no longer suitable for use with the current Gasman. We recommend that such chargers be replaced with the newer model shown above (see Section XI, Accessories and spare parts, p32).

The charging time will be longer if the unit is switched on during charging.

When Gasman is fully charged and switched on the battery icon will display three full bars.

3.3 Changing rechargeable batteries

It is recommended that rechargeable batteries should be changed by an authorised Crowcon service centre only.

3.4 Non-rechargeable batteries

Gasman uses a Lithium Cell battery pack which will give up to two years of operation.

Always switch the Gasman off before opening the case to change the battery.

To replace the battery, ensure you are in a safe, non-hazardous area. Remove the back cover and remove the battery*. Insert the replacement battery into the instrument and securely fasten the back cover.

Note: When a non-rechargeable detector is placed in the charger/charger interface the red LED will not illuminate and the detector will not charge.

* Note: later versions of the Gasman will have a tab in place to aid removal of the battery.

IV. Alarm indications

Gasman provides two instantaneous alarm levels, designated level 1 and level 2. For toxic gas sensors, there are also two TWA alarms, one for short term exposure (STEL): based on a 15 minute time weighted average, and the second TWA alarm is for long term exposure (LTEL): based on a 8 hour time weighted average.

Alarm configurations are set via the Crowcon Portables PC software. The following settings can be made:

Alarm thresholds for each sensor: Level 1 and level 2 instantaneous alarms.

AL-1
AL-2

Alarm trigger: This can be set to rising levels of gas concentration, or as falling. Oxygen units are set to falling for deficiency monitoring.

Alarm latching: Alarms can be set to be latched or unlatched. Latched alarms will require the button to be pressed in order to clear the alarm once the hazard has passed. This is the default setting. Unlatched alarms will clear automatically when the gas hazard has passed, but not until then.

Alarm mute: The sounder can be set to mute for level 1 alarm only; pressing the operator button during an alarm condition i.e. presence of hazardous gas, will silence the sounder and stop the vibration alarm. The alarm LEDs will continue to flash.

Alarm sounder tone: Different distinctive tones can be selected for the each alarm condition to achieve the best performance for the monitoring conditions available.

In the event of a Time Weighted Alarm (TWA)

In the event of the 15 minute or the 8 hour TWA being triggered, Gasman will go into alarm and display a TWA warning with the toxic gas readings. Neither the 15 minute nor the 8 hour TWA alarm can be cleared.

LTWA
STWA

In the event of a Flammable overrange alarm

If flammable gas concentrations exceed 100% LEL Gasman locks into alarm and displays '9999' showing an overrange condition. Gasman will temporarily cut off power to the sensor to prevent burn out and display a progress bar for 200 seconds. When the timeout is complete, either press the button to continue or switch your unit off and on to restart. This option is programmable with Crowcon Portables PC software and the default is switched on.

A digital display showing the number '9999' in a seven-segment font, representing an overrange alarm condition.

If the Gasman goes over range at any time it is recommended to carry out a gas test before using it again.

V. Fixing Accessories

Clip Accessories

Gasman is supplied with an alligator clip. Other clip options are:

Hard hat clip

Allows Gasman to be clipped to a hard hat, a method of wearing a portable gas detector preferred by many users.

Pocket Clip

Allows Gasman to be clipped to a pocket, near the breathing zone of the user.

Universal harness plate

Crowcon provide a universal harness plate which can be used with either a chest harness or a shoulder strap.

How to wear your Gasman unit

Chest harness

Use the M3 fixing (usable once the clip has been removed) on the back of your Gasman unit to attach the chest harness plate. Create a chest harness by attaching one strap to the top connectors, to go around the neck, and the other to link around the waist using the side connectors. Adjust the strap lengths until the Gasman unit is in a comfortable working position.

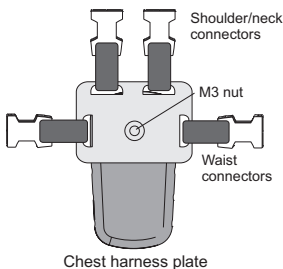

Shoulder strap

With the universal harness plate in place on the belt clip, attach the shoulder strap accessory onto the top connectors. Adjust to a comfortable working position.

See Accessories, section XI, for full list.

VI. Flow sampling

Attaching the flow cap

To perform manual sampling using Gasman, a flow cap must be fitted onto the front of the unit, over the sensor. A flow cap is included with your Gasman unit.

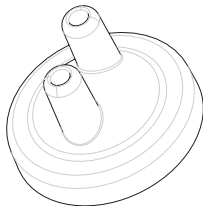

1. To fit the flow cap, firstly ensure the cap gasket is intact, slip the flow cap over the sensor on the front of your Gasman unit, until the cap is tightly fitted into place.
2. Attach the sampling tube or flow accessory onto a gas nozzle.
3. Attach the aspirator bulb onto the remaining gas nozzle.
4. To remove the flow cap, gently tease the cap from the sensor and lift the cap away from the instrument.

When using the manual aspirator kit, adopt a consistent rhythm whilst using the hand aspirator. Crowcon recommend squeezing once per second to achieve a flow rate of approximately 0.5 - 1 litre/min. At least 10 pumps per sample are recommended.

The sampling tube supplied is normally a 2m (6ft) length. Longer lengths of sampling tube can be provided, but will increase the time taken to get a sample from the point of sampling to the Gasman instrument. When using an extended length of tubing a response time test is recommended. Gas of known concentration should be sampled along the full length of tubing to be used and the time taken for the sensor reading to reach the known gas levels should be noted. This time should be used as the minimum for sampling before readings should be taken.

Gasman gas test accessory kit

The Gas Test Accessory is a gas testing kit designed to enable gas testing and one button calibration of your Gasman gas detector using a specially formulated, high stability long life single gas mix. It can be used with Gasman units having sensors for Flammable, Oxygen, Carbon Monoxide and Hydrogen Sulphide gases.

6.1 Gas testing

Gas testing checks the sensor is responding within set limits to an applied gas of known composition. This can be performed as often as desired, but would usually be carried out each time the Gasman is issued for use. The Gasman itself will determine Pass/Fail status for the gas test.

In order to perform successful gas tests you should ensure:

- The gas used has the correct gas concentration, and that it is within the validity date specified by the supplier.
- The gas flow path is leak tight. It is important to check that the flow cap is properly fitted to the Gasman unit, and the outlet tubing is not restricted in any way, nor additional tubing length used.

The Gas Test Accessory Kit comprises a gas cylinder containing the gas, a 'Trigger' regulator with interconnect tubing, a magnet - used to activate Test mode, a flow cap to attach to the Gasman, and a vent line. The kit is supplied in a convenient carry case. The Trigger regulator can be operated in two ways: (1) squeeze and hold - allows gas flow as long as the lever is held in, or (2) by lifting the lever - the flow is locked on.

6.2 How to perform a gas test

1. Ensure your Gasman unit is switched on and in normal operation.
2. Fit the flow cap onto the front of the sensor and attach the hose from the Trigger regulator.

Attach the outlet hose to 'vent gas away' - do not extend this hose and do not restrict or allow kinks.

3. Touch the magnet, horizontally aligned onto the case, to the left hand side of the display (as shown left). Your Gasman unit will activate the Gas Test and show 'TEST' on the display.

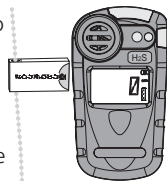

- Gasman will display a progress bar. Apply the gas whilst the progress bar is counting down. The display will alternate between the screens shown right.



Gasman will then display 'PASS' or 'FAIL'

In the event Gasman displays 'FAIL', please see the troubleshooting guide in the first instance or contact Crowcon or your local service centre.



- To abort the gas test press the button at any time whilst the test is in progress.

6.3 How to perform a one button calibration test

To perform a one button calibration test, you must first perform a Zero on your Gasman unit.

- Ensure you are in clean air.

Double click the button and select Zero from the Options menu.

Gasman will perform a Zero.

To perform a one button Calibration, complete the next steps within 15 minutes of completing the Zero.

- Follow steps 1 to 3 given in 6.2, Gasman will display 'CAL' and '????' alternately. Press the button to confirm one button Calibration. If the button confirmation for calibration is not made within 10 seconds then the process will revert to test as in 6.2.
- Apply calibration gas following step 4 in 6.2.
- To abort the Calibration test press the button at any time whilst the test is in progress.

Your Gasman unit will adjust the value for the gas channel to match the stored calibration gas value within the sensor i-module. This will also change the calibration due date which is set as a default of 182 days.

If your Gasman unit does not calibrate successfully, Gasman will display 'FAIL'. Your Gasman unit must be sent to Crowcon or a local service centre for re-calibration.

Any Gas Test 'pass' and 'fail', and calibration 'pass' and 'fail' and their values are stored in the Event log.

6.4 Gas test/calibration troubleshooting

Symptom	Possible Cause	Action
No response to gas	Gas cylinder empty	Check gauge, replace cylinder as needed
	Hose blocked or kinked	Ensure no restriction to flow
Gasman fails gas test	Gas cylinder empty	Check gauge, replace cylinder as needed
	Gas cylinder out of date	Check date and replace as needed
	Hose blocked or kinked	Ensure no restriction to flow
	Calibration drifted	Calibrate Gasman
	Gas flow not started immediately	Repeat test, starting gas immediately
Gasman fails calibration	Gas cylinder empty	Check gauge replace bottle as needed
	Gas cylinder out of date	Check date and replace as needed
	Hose blocked or kinked	Ensure no restriction to flow
	Calibration drifted	Calibrate Gasman
	Stabilisation time too short	Reset using PC software
Gasman passes gas test but will not enter calibration mode	Menu Zero not performed	Select and perform Zero from menu
	Gasman not configured for field button calibration	Send for re-configuration

Note: Remove regulator from gas cylinder when not in use over a prolonged period. This will cause the gas to leak.

For parts list, see section XI.

One button Calibration will check for small drifts of stored calibration value, but Crowcon recommends Gasman is sent for full certified calibration at six monthly intervals.

VII. Maintenance and Calibration

Gasman is designed to operate almost maintenance free under most conditions. However, some small items of routine maintenance are recommended.

General

To keep the display panel and operator button free from dirt build up, regularly wipe over your Gasman unit with a damp cloth.

Filter

Inspect the front filter at regular intervals for dirt or damage. Clean as necessary.

Zero and calibration

Gasman is supplied with an Autozero function on start-up. This function can be configured to operate automatically, on user confirmation (see quick start guide), or can be disabled. This configuration can be set with the Crowcon Portables PC software, see section VIII. Gasman also has a Zero function in the menu, see section 2.4.

Crowcon recommends a monthly gas test to confirm sensor operation. However, please check with your own Health and Safety regulations. A test gas of known composition needs to be applied to verify sensor response and alarm function, see section 6.1.

Instrument calibration of sensor should be performed at 6 month regular intervals.

Calibration method

Gasman calibration can be performed using the Gas Test Kit as per 6.3 or with Crowcon Portables PC software and calibration gas mixtures. Appropriate certified calibration gases should be used. Calibration gas is applied using the appropriate flow cap. Refer to Crowcon Portables PC software help file for further information.

Gasman IR CO₂ Personal Detector

The concentration of CO₂ in fresh air is 0.04% by volume. A correctly zeroed Gasman IR CO₂ monitor will read 0.04% in uncontaminated ambient air.

Before zeroing the Gasman must be in fresh uncontaminated air well away from a building or any CO₂ emissions. Hold the unit well away from the breathing zone of the operator – i.e. at arm's length. When Gasman IR CO₂ is zeroed in fresh air it automatically sets the CO₂ baseline level to 0.04%.

Gasman IR CO₂ can also be set to zero in nitrogen using the PC interface and Portables PC software. This is in effect a zero point calibration rather than a normal zero. To do this, after uploading the instrument configuration file, note the existing calibration gas level, then set the calibration value to 0.00%, apply nitrogen gas and click the Calibrate button. After this zero point calibration is completed, remember to re-set the calibration gas level to its previous level.

Nitrogen for zeroing should be provided from a suitable gas bottle at a regulated flow of 0.5 l/min (1 SCFH), connected to the standard flow cap clipped over the sensor aperture. Recommended calibration gas is 2% CO₂ in a background of nitrogen.

Care should be taken to vent the nitrogen flow away from the operator and not allow nitrogen flow for longer than necessary to complete the zeroing. If indoors it is recommended to vent gas out of a window or into an extracted fume cupboard.

Ozone sensor

Due to the reactive nature of ozone (O₃) special procedures should be followed when calibrating gas detectors that incorporate an ozone sensor. By following the guidelines for calibration below users will maximise the protection level that their gas detectors give them.

Always calibrate Crowcon ozone detectors with ozone only.

Fittings

For ozone calibrations all fittings and pipework should be stainless steel, brass, aluminium or PTFE. Fittings or pipework in other plastic materials such as Tygon must not be used.

Gas flow rate

It is important that the flow rate is set correctly as otherwise pressure effects may distort calibration values and prevent the gas detector from working correctly. To calibrate Crowcon portable detectors the flow rate should be set between 0.8-1.0 litres/minute (0.03-0.04 cubic feet/minute).

Normal safety precautions for handling ozone should always be observed along with any special instructions that accompany the calibration gas cylinder or generator being used.

The standard flow plate should be used to supply gas at the flow rate stated above.

If required your local Crowcon representative or service centre will be able to provide further advice.

VIII. PC interface and software

Gasman can be connected to a PC using the single way charger unit with optional PC interface. The charger unit is fitted with a D-type 9 pin RS232 socket which is located at the rear of the charger, see diagram below. The PC requires Crowcon Portables PC software. A USB-RS232 adaptor is also available from Crowcon.

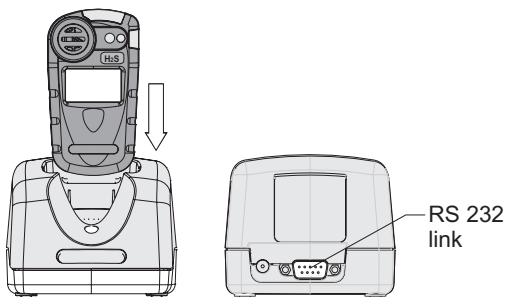

The software provides the user with access to reconfigure alarm levels, operation, run calibrations, print reports and to access data and event log files.

Set-up

1. Install *Portables PC software* on PC and attach the RS 232 cable to the charger and PC.
2. Switch on the Gasman unit and drop it into the charger unit with the display facing forward.
3. For information on using the Crowcon Portables PC software, see installed help file.

Data logging

Data is logged at a rate set by the log period which is configurable via Portables PC software. This is set at 1 minute intervals as a default.

The Gasman is capable of storing 54,000 logs (>4,800 events). When the memory is filled, new data then overwrites the oldest data.

A log can be extracted from the Gasman and saved using Portables PC software.

The instrument will record the following events:

- Switch on/off
- Battery status
- Sensor channel over-range
- Alarms activated/cleared (including peak values of response)
- Gas test pass/fail
- User triggered event

For more information on using Crowcon Portables PC software see the installed help file.

IX. i-module replacement

Installing or replacing an i-module

1. Ensure you are in a non-hazardous (safe) area, with suitable ESD protection.
Switch off the unit
2. Remove the back cover by unscrewing the four M2.5, 12 mm Torx (T6) screws as shown the in the drawing, point ①. Do not touch the charging elastomer connector with your fingers.

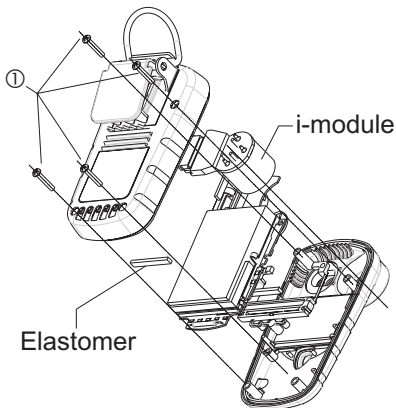

3. Place the Gasman unit face down on a surface.
4. Unclip the i-module from its retaining support clip. Ease one side out at a time. Ensure the elastomer which is retained within the body of the support clip remains in place and should not be touched by hand.
5. Unwrap the replacement i-module from any packaging and ensure the sensor is fully seated on the module board.

If replacing an i-module with one of the same type, instrument specific configuration will be retained. If replacing with a different i-module its default configuration will be loaded.

6. Ensure the gasket is in place on the sensor. Then slip the sensor onto the sensor housing. Click the quick release fixings around the i-module board, ensuring the i-module is held in place firmly and the sensor is still tightly located on the module board.
7. Replace the back of the Gasman case and secure with screws.
8. Switch on the Gasman unit. The new i-module will be automatically recognised.
9. Crowcon advise carrying out a calibration check when any new sensor is fitted.

X. Specification

Dimensions	90 x 48 x 24 mm (3 1/2 x 1.9 x 1 inches)
Weight	138 g flammable 129 g oxygen 118 g toxic
Housing, degree of protection	Ingress protection IP65 (NEMA 4)
Operating temperature	-20°C to +55°C (-4°F to +131°F)
Humidity	20-99% RH, non-condensing for continuous operation
Display	Custom LCD with backlight. Starburst characters for number and text display, plus screen icons for status and mode.
Warm up time	90 seconds maximum
Response time (typical)	(T90) : approx 20 seconds for most toxic and flammable sensors, 10 seconds for oxygen.
Audible Alarms	95 dBA (Multiple alarm sounds allow selection of distinctive tones for different alarms).
Visible Alarms	Dual colour red/blue flashing LEDs in gas hazard.
Vibrating Alarm	Internal vibrating alarm.
Repeatability	±2% FSD, 6 months
ATEX Safety certificate no.	Essential Health and Safety Requirement, clause 15.9 BASEEFA04ATEX0383 Flammable Gas BASEEFA04ATEX0384 Oxygen or Toxic Gas
IECEX	IECEXBAS05.0038 Flammable Gas ECEXBAS05.0039 Oxygen or Toxic Gas
Approval codes	
Europe:	ATEX II 1G Ex ia IIC T4 Ga, (-20°C ≥Ta≥ +65°C) Toxic/Oxygen ATEX II 2G Ex ia d IIC T4 Gb, (-20°C ≥Ta≥ +65°C) Flammable
USA:	Class I Division 1, Groups A, B, C and D
Canada:	Class I Division 1, Groups A, B, C and D
Standards	
Safety:	Baseefa 04ATEX0383 EN 60079-0: 2012 EN 60079-1: 2007 EN 60079-11: 2012 94/9/EC IEC 60079-0 : 2011 IEC 60079-1 : 2007-04 IEC 60079-11 : 2011 Baseefa 04ATEX0384 EN 60079-0: 2012 EN 60079-11: 2012 94/9/EC IEC 60079-0 : 2011 IEC 60079-11 : 2011
Canada: Operation	CSA22.2, 152 EN50270, EN50271

XI. Accessories and spare parts

Accessory list

Crowcon part number	Description
Single way chargers	
C01941	Single way charger 12Vdc input
C011318	Single way charger with multi-region power supply
C011011	Single way charger 230V in-line power supply, no plug
C011009	Single way charger 110V in-line power supply, no plug
C01945	Single way charger 90-260V in-line power supply
C01296	Charging lead for vehicle lighter socket lead
C01940	Single way charger/interface 12Vdc input
C011305	Charger interface kit (includes single way charger/interface, USB-RS232 adaptor and PC lead, multi-region power supply)
C011319	Single way charger/interface with multi-region power supply
C011012	Single way charger/interface 230V in-line power supply, no plug
C011010	Single way charger/interface 110V in-line power supply, no plug
C01950	Single way charger/interface with 90-260V in-line power supply
Multiway charger	
C01951	5-way multiway charger without power supply
C011041	5-way multiway charger with 90-260V in-line power supply, US power supply
C011042	5-way multiway charger with 90-260V in-line power supply, UK power supply
C011043	5-way multiway charger with 90-260V in-line power supply, EU power supply
i-modules:	
S011424/M	0-100% LEL methane
S011436/M	0-100% LEL propane
S011437/M	0-100% LEL pentane
S011439/M	0-100% LEL butane
S011440/M	0-100% LEL ethylene

S011460/M	0-100% LEL hydrogen
S011423/M	0-25% oxygen - add /USA for USA alarm config.
S011422/M	0-500 ppm carbon monoxide
S011421/M	0-100 ppm hydrogen sulphide - add /USA for USA alarm config.
S011425/M	0-10 ppm sulphur dioxide
S011429/M	0-2000 ppm hydrogen
S011426/M	0-20 ppm nitrogen dioxide
S011428/M	0-20 ppm chlorine
S011432/M	0-1 ppm ozone
S011430/M	0-25 ppm hydrogen cyanide
S011435/M	0-100 ppm ammonia
S011438/M	0-1000 ppm ammonia
S011431/M	0-5 ppm phosphine
S011434/M	0-1 ppm fluorine
S011433/M	0-10 ppm hydrogen fluoride
S012171/M	0-5% Gasman IR (carbon dioxide) CO ₂ i-module (for use in safe areas only)

Sampling accessories:

M04852	Flow cap
C01937	Aspirator Assembly
	Calibration gas contact Crowcon - required gases depend on sensor combination

Carrying and wearing:

C01952	Harness Plate
C01843	Shoulder Strap
C01844	Chest Harness Straps
C01953	Hard Hat Clip
M02362	Alligator Clip
C03329	Metal Clip

Communications:

E07532	PC Interface Lead
C01832	PC Software
C02097	USB to RS232 adaptor

Spares / consumables:

S011818/1	Rear Moulding
-----------	---------------

M04973	Gasman front and rear moulding set
E01918	Non-rechargeable Battery
E07621	i-module Elastomer
E07620	LCD Elastomer
M04682	Sensor Sealing Ring
M03705	Clip retaining nut M3
M03793	Case screw
M05910	Crowcon domed label
E01552	Power Supply for charger - 230 V No plug
E01553	Power Supply for charger - 115 V No plug
E07693	Power supply for charger Universal 90-260 V
C03580	Multi-region power supply (includes UK, EU, US and Australian plug adapters)

XII. Troubleshooting guide

Symptom/ error message	Cause	Action
Instrument won't switch on	Flat battery	Recharge or replace battery.
No confidence beep	Function disabled	Reconfigure with PC software.
Gas reading when no gas present	Zero drifted	Restart instrument in clean air.
Unstable/inaccurate gas reading	Sensor failure	Do not use; exit hazardous area immediately. Return instrument for recalibration or sensor replacement.
Autozero failed	Zeroing in contaminated atmosphere	Switch off and restart in clean air.
Cannot Autozero due to alarm	Zeroing in contaminated atmosphere	Switch off and restart in clean air.
Calibration expired	The calibration due date has passed	Send for calibration.
Display shows empty battery symbol on switch on	Battery depleted	Charge or change as appropriate.

Appendix: Limitations of sensors

Sensor limitations

The sensors used in Gasman have limitations common to all such gas sensors, and users should be aware of the points listed below. Crowcon can advise on particular situations and suggest alternative sensors if the instrument is likely to experience extreme conditions.

Gasman Flammable uses a catalytic gas sensor, which measures the flammability of the gas. For this reason, readings displayed on the unit will be unreliable over concentrations of approximately 120% LEL. Oxygen is necessary for catalytic sensors to operate. A 'pellistor saver' is used to disconnect power to the pellistor sensor in the event of over-range to prevent burn out. This locks out the unit for 200 seconds after which a button press will reconnect power to the pellistor. If the sensor power is reconnected when the unit is exposed to an over-range gas concentration there is a risk of damage to the pellistor sensor. Restart should be carried out in a known fresh air environment. Depleted oxygen levels can reduce the flammable gas reading, and if oxygen levels are below safe breathing limits it should be assumed that the flammable reading is low.

Electrochemical gas sensors, toxic gases or oxygen, contain chemicals. Extreme levels of humidity can also cause the sensor to be unstable. The sensors are rated for an (average) ambient of 20-90% R.H. However they are used from the tropics to deserts to tundra.

Water should not be allowed to collect on the sensor as this may impede gas diffusion.

Persistent exposure to high levels of toxic gas will shorten the life of a toxic sensor. If the high level gas is corrosive (e.g. hydrogen sulphide) damage may occur over time to metal components.

Sensors may be cross sensitive to other gases. If unsure, contact Crowcon or your local agent.

A HALMA COMPANY



UK Office

Crowcon Detection Instruments Ltd
172 Brook Drive,
Milton Park,
Abingdon
Oxfordshire
OX14 4SD
Tel: +44 (0) 1235 557700
Fax: +44 (0) 1235 557749
Email: sales@crowcon.com
Website: www.crowcon.com

USA Office

Crowcon Detection Instruments Ltd
1455 Jamike Ave, Suite 100
Erlanger
KY 41018
Tel: +1 859 957 1039 or 1 800 527
6926
Fax: +1 859 957 1044
Email: salesusa@crowcon.com
Website: www.crowcon.com

Netherlands Office

Crowcon Detection Instruments Ltd
Vlambloem 129
3068JG, Rotterdam
Netherlands
Tel: + 31 10 421 1232
Fax: + 31 10 421 0542
Email: eu@crowcon.com
Website: www.crowcon.com

Singapore Office

Crowcon Detection Instruments Ltd
Block 194, Pandan Loop
#06-20 Pantech Industrial Complex
Singapore 128383
Tel: + 65 6745 2936
Fax: +65 6745 0467
Email: sales@crowcon.com.sg
Website: www.crowcon.com

China Office

Crowcon Detection Instruments Ltd
(Beijing)
Unit 316, Area 1, Tower B, Chuangxin
Building
12 Hongda North Road, Beijing
Economic Technological Development
Area
Beijing, China 100176
Tel: +86 10 6787 0335
Fax: +86 10 6787 4879
Email: saleschina@crowcon.cn
Website: www.crowcon.com