

High Definition VideoScope

Model HDV500

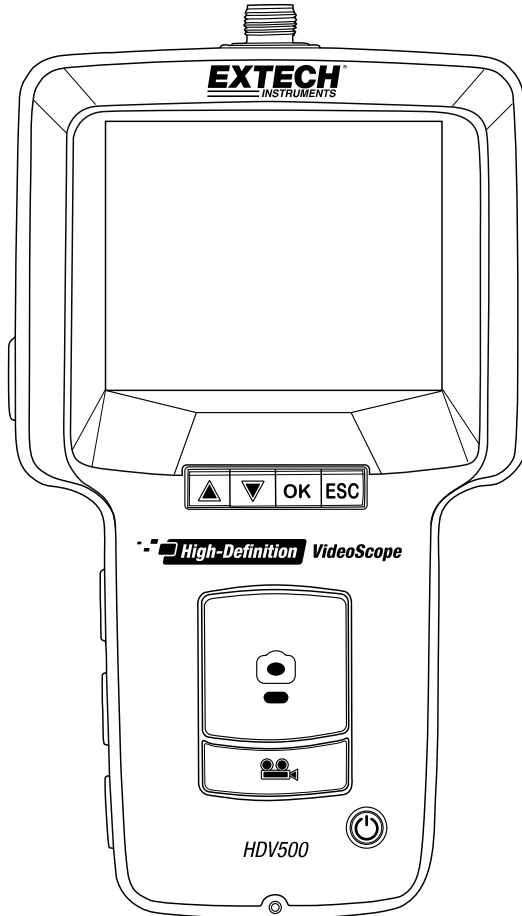

Table of Contents

1. INTRODUCTION	3
1.1 Models and Descriptions	3
1.2 Features	3
2. SAFETY	3
3. QUICK START	4
4. MAIN UNIT AND CAMERA DESCRIPTIONS	5
4.1 Main Unit Description	5
4.2 Camera Description	5
5. BUTTON DESCRIPTIONS	6
6. COMMON DISPLAY ICONS	6
7. RECHARGEABLE BATTERY AND AC POWER ADAPTOR	7
7.1 Rechargeable Battery	7
7.2 Universal AC Power Adaptor	7
8. OPERATION	7
8.1 Connecting and Powering the System	7
8.2 Main Display	7
8.3 Camera Articulation Control	8
8.4 Magnification (Zoom)	8
8.5 Video Recording, Viewing, and Deleting	8
8.6 Audio Voice-Over with Video Recording	8
8.7 Image Capturing, Viewing, and Deleting	9
8.8 LED Work Lamp Intensity Control	9
8.9 System Reset Button	9
8.10 AV Connection to External Monitor	9
8.11 USB Connection for PC File Transfer and Battery Charging	9
9. FUNCTION PROGRAMMING MENU	10
9.1 Storage Devices (SD Cards and USB Flash Devices)	10
9.2 Set DATE/TIME and AUTO POWER OFF Time	11
9.3 AV Output Selections	11
9.4 Factory Default Reset and Firmware Version	11
9.5 Image and Video Files	12
10. MAINTENANCE	12
10.1 Cleaning	12
10.2 Battery Replacement	12
11. SPECIFICATIONS	13

1. Introduction

Thank you for selecting this Extech High Definition VideoScope with articulating camera probe. This instrument is designed for use as a remote inspection device. It can be used to peer into tight spots and typically inaccessible places. This instrument can record, playback, store, and transfer video and images to a PC. Typical applications include HVAC installation and troubleshooting, cable routing, and automotive/maritime/aircraft inspection.

This meter is shipped fully tested and, with proper use, will provide years of reliable service. Please visit our website (www.extech.com) to check for the latest version of this User Guide, Product Updates, Product Registration, and Customer Support.

1.1 Models and Descriptions

- HDV500 VideoScope (Main Unit Monitor only)
- HDV540 Kit: VideoScope with camera probe (HDV5-6CAM-1AFM)
- HDV5-6CAM-1AFM: Flexible macro camera probe, 1m cable, 6mm diameter

1.2 Features

- Image and video recording
- Image and video preview on LCD screen
- Glare-free close-up field of view
- Image and video storage to SD CARD or USB flash device
- Images and video transfer to a PC
- Adjustable LED intensity for camera
- NTSC and PAL output signal options (supplied AV cable)
- Digital zoom up to 4X for video and up to 10X for images
- Image rotation
- Voice recording and playback
- Li-Polymer 3.7V rechargeable battery included
- Universal AC power adaptor supplied
- USB port for charging battery and transferring images to PC. USB cable supplied.
- Headset jack for recording voice-overs on video recordings (headset not included)

2. Safety



CAUTION

For the Articulating Probe, do not operate the articulation knob with the probe in a coiled configuration. This will damage the articulation controls!

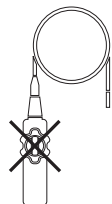

3. Quick Start

1. Carefully unbox the equipment.
2. Connect the camera to the keyed jack (8) at the top of main unit and secure tightly with the nut.
3. Connect the camera to the screw hole (back of main unit) for mounting.
4. Insert an SD Card into the slot (7) at the upper right side of main unit.
5. Remove the protective decal from the main unit display.
6. Press and hold the Power button (1) to power up. If the system does not start, please recharge the battery or use the supplied AC power adaptor.
7. With the system powered, view the live camera image on the display. Zoom with the down arrow to 4X.
8. Use caution when maneuvering and adjusting the camera probe and do not subject the camera probe to extreme bending positions.
9. Use the Image (photo) button to take snapshots of the camera images and use the Video button to start and stop digital video recording.
10. To view stored images or videos, press the up arrow in the image or video mode. Use the arrow keys to scroll and use the OK button to open an image or video. Basic functions:
 - Zoom stored Images: Press PHOTO button in the viewer mode
 - Video Pause/Resume: Press OK button in video view mode
 - Video Restart: Short press either arrow button in video view mode
 - Video Search: Long press on up arrow [rewind] or down arrow [fast-forward]
 - Press ESC from the image or video viewer to return to the main display
11. Transfer images to a PC as described later in this manual using USB cable.
12. Configure and customize the system using the Functions Menu (press OK).
13. When finished, turn power off by holding the power button for 2 seconds and then pack the system in the supplied protective carry case.
14. Please read the entire user manual to learn about other useful and advanced features.

4. Main Unit and Camera Descriptions

4.1 Main Unit Description

1. Power button
 2. Video Record button with sub-functions
 3. Snapshot (photo) Image button
 4. Power adaptor jack
 5. Audio headset jack (for voice-overs)
 6. AV Output jack (PAL or NTSC)
 7. SD Card slot
 8. Keyed Camera signal jack
 9. Monitor display
 10. USB jack
 11. Function buttons (seen next section)
 12. Camera LED work lamps intensity adjust
- Note:** Reset button & mounting hole on back of unit.

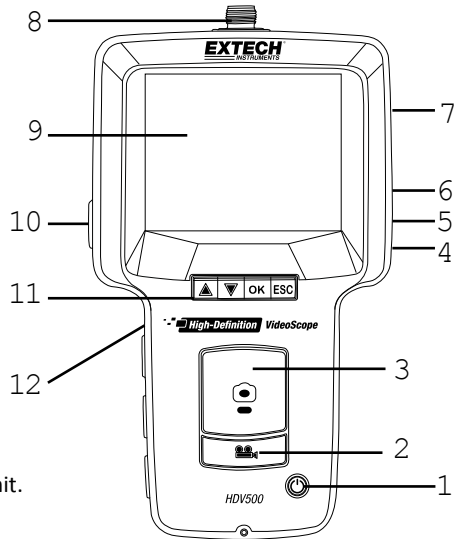



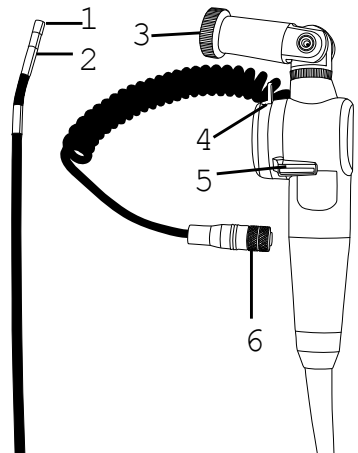
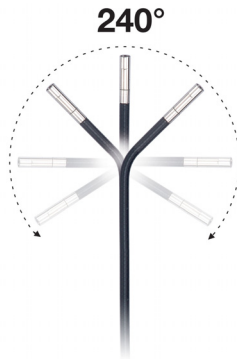

4.2 Camera Description

1. LED work lamps (4)
2. Camera with macro lens
3. Mounting screw connects to back of main unit
4. Camera position lock mechanism
5. Articulating (240°) control remotely points the camera lens
6. Camera signal cable connects to top of main unit









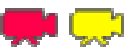

5. Button Descriptions

	Long press to power ON or OFF
	<ul style="list-style-type: none"> • Open Image viewer from image mode or Video viewer from video mode • Browse image and video files • Scroll in the Programming Menus • Restart a video in video viewer
	<ul style="list-style-type: none"> • Zoom the live camera image from 1X to 4X • Browse image and video files • Scroll in the Programming Menus • Restart a video in video viewer
OK	<ul style="list-style-type: none"> • Press to open the Function Programming Menu • Press to enter and confirm functions
ESC	Press to return to the prior menu or to the main display
	<ul style="list-style-type: none"> • Press to switch to image standby mode and to take and store a snapshot • Decrement a programming value
	<ul style="list-style-type: none"> • Press to switch to video standby mode and to start/stop video recording • Increment a programming value • Open the video trash utility from the video viewer

6. Common Display Icons

This is a list of the most commonly displayed icons. Menu and other icons are presented in the user manual sections where they apply.

	The red video icon is shown while video is being recorded; The yellow video icon is shown when in the standby video mode.
	The red camera icon is shown when a snapshot image is taken; The yellow camera icon is shown when in the standby image mode.
	Battery charge level
1X...4X	Camera zoom levels
00:00:00	Video recording elapsed timer
2015-12-14	Date (YYYY:MM:DD)
22:56:25	Clock time (HH:MM:SS)
	SD Card or USB Flash Drive successfully formatted
	Error signal indicating that images or videos were not saved to SD Card or USB Flash Drive (typically due to lack of free space on a storage device)
	SD Card locked. SD Card must be unlocked before it can be used
	Video Play and Pause icons
	Video fast-forward and fast-rewind

7. Rechargeable Battery and AC Power Adaptor

7.1 Rechargeable Battery

When the battery icon  appears empty on the LCD, the battery must be charged. The system uses a rechargeable Li-Polymer 3.7V battery (supplied installed). Note that the system can be used normally while it is charging.

Connect the supplied USB cable to the USB port (10) on the left side of the main unit (under the protective flap) and to a PC USB port. Then follow the programming instructions in Section 8.11, *USB Connection*, for complete details. A full charge requires 5 hours. The internal battery is not user serviceable.

The Universal AC Power Adaptor can be used to recharge the battery as explained in the next section.

7.2 Universal AC Power Adaptor

The system also includes a Universal AC Power Adaptor for powering the system and recharging the battery. The AC Power Adaptor jack (4) is located on the upper right side of the main unit under the protective flap.

8. Operation

8.1 Connecting and Powering the System

- Connect the camera's signal cable to the keyed jack (8) at the top of the main unit and secure tightly with the nut.
- Mount the camera to the main unit using the mounting screw hole on the back of the main unit.
- Insert the SD CARD into the slot (7) on the upper right of the main unit. Use the proper insertion orientation and do not force the card. USB Flash Drives can be used as explained later in this manual.
- The supplied Li-Polymer rechargeable 3.7V battery powers the system. Alternatively, use the supplied universal AC power adaptor to power the system.
- Press and hold the Power button (1) for 2 seconds to switch the meter ON. If the main unit does not power up, please charge the battery or use the supplied AC power adaptor.
- Check that camera and main unit are operational by viewing the displayed camera image.

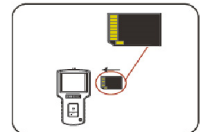
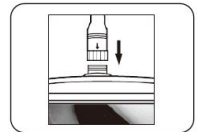

8.2 Main Display

The main display appears as shown.

1. Camera image area
2. Video recording elapsed timer
3. Magnification level (zoom)
4. Battery power status
5. Mode icon (video or photo)
6. Date and Time

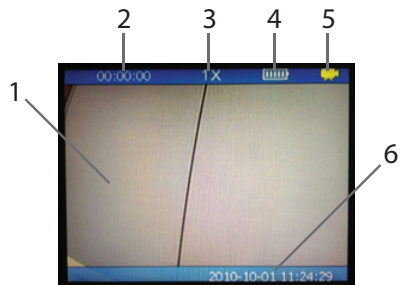



8.3 Camera Articulation Control

Use the articulation control (item 5 in the camera description section) to point the camera lens in the desired direction. The articulating camera has a bend radius limit of 240°.

8.4 Magnification (Zoom)

Use the down arrow button to zoom up to 4X on a live camera image. The magnification level is shown at the top, middle of the main display. Note that in the stored image review mode, images can be zoomed up to 10X.

8.5 Video Recording, Viewing, and Deleting

- Press the Video button (2) to begin recording. The yellow video icon (upper right) turns red while recording and the elapsed timer (upper left) begins counting.
- Press the Video button again to stop recording; the red video icon will return to yellow and the elapsed timer will reset to zero. The hourglass icon is shown when a recording (.avi) is being saved to the SD CARD or Flash Drive.
- This error symbol  appears if the storage device does not have enough free space.
- The Lock symbol  will appear if the SD Card is locked. To unlock the SD Card, first turn the system OFF, remove the SD Card from the slot, and switch the SD Card tab position.
- To view videos, press the up arrow from the main display and a list of video recordings will appear. Use the arrows to highlight a video and press OK to view it.
- The features below are available when viewing a video:
 - Short press on either arrow button jumps back to the beginning
 - Long press on an arrow button fast-forwards (up arrow) or fast-rewinds (down)
 - Use OK button to Pause/Resume
 - Use the ESC button to return to the main display.
 - Video button opens the trash utility. Use arrows to highlight the check mark (delete video) or the 'X' (keep video); press OK to complete the function.

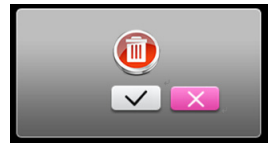

8.6 Audio Voice-Over with Video Recording

The video recording function of this device offers audio voice-over recording. Connect a microphone headset to the headset jack (5) on the right side of the meter (under the protective flap). Audio recording begins automatically when video recording starts.

8.7 Image Capturing, Viewing, and Deleting

- Press the Image button (3) to take a snapshot of the screen. The yellow icon (upper right) will briefly turn red and return to yellow when the snapshot (.jpg) has been stored on the SD Card or a USB Flash Device. The hourglass appears while the image is being saved.
- The red error symbol will appear if the storage device does not have enough free space. The Lock symbol will appear if the SD Card is locked. To unlock the SD Card, first turn the meter OFF, remove the SD Card from the slot, and switch the SD Card tab position.
- Press the up arrow to open the image files. Use the arrow keys to scroll and use OK to open an image. The date and time that the image was taken is also shown.
- Use the OK button to rotate the image (90° rotation with each press of the button).
- Use the CAMERA button to select a zoom level (from 1X to 10X).
- Use the VIDEO button to open the trash utility. Use the arrow buttons to highlight the check mark (delete image) or the 'X' (don't delete) and then press OK.
- Press ESC to return to the stored image list. Press ESC again to return to the main display.

8.8 LED Work Lamp Intensity Control

Use the brightness adjust dial (11) on the left side of the main unit to adjust the brightness of the camera work lamps to the desired level. Higher settings will drain the battery quicker than lower brightness levels.



8.9 System Reset Button

If the operating system appears locked or frozen, press the recessed reset button on the back of the main unit, using a paper clip or small tool, to reset the system.

8.10 AV Connection to External Monitor

This instrument includes an AV output port (6) on the upper right side of the main unit (under the protective flap). Connect the main unit to a monitor using the supplied RCA-to-PHONO cable (PHONO end connects to the main unit and two RCA plugs connect to the jacks on the external monitor). The system will send AV signals to the monitor for remote viewing when connected.

8.11 USB Connection for PC File Transfer and Battery Charging

- Connect the system to a PC using the supplied USB cable, via the USB port (10) on the main unit (right side, under protective flap).
- A dialog box appears prompting the user to select DATA mode (PC transfer) or Battery Charging mode.
- Navigate to the upper block (Data mode)  using the arrow buttons and then press OK to allow the transfer of files to and from the SD Card and the PC. The USB Connection LOGO displays on screen. Now the PC sees the main unit as any other external drive where files and folders can be dragged and dropped.
- Select the lower block  for Battery Charging mode. The main instrument's battery status icon will animate as charging is taking place. Please allow up to 5 hours for a complete charge.

9. Function Programming Menu

- Press the OK button to open the main function menu.
- Use the up and down arrow buttons to scroll to one of the 5 menu options.
- Press OK to open a highlighted selection.
 1. Storage Device management (SD Card or USB Flash)
 2. Date and Time setting
 3. AV output selection (PAL or NTSC)
 4. Factory default reset and Firmware version
 5. Stored Image/Video folders/files navigation





9.1 Storage Devices (SD Cards and USB Flash Devices)

From the main menu, use the arrow buttons to scroll to the Storage Device icon and press OK to open it. There are three rows of selections in this menu.

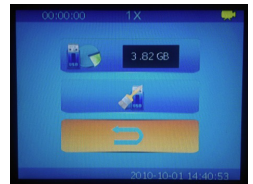
ROW 1 (top). Select a storage device (SD Card or USB Flash Drive) with the OK button*. Also view the remaining storage capacity of the selected device.





This symbol  on row 1 indicates that the system is using a USB Flash Drive.



This symbol  on row 1 indicates that the system is using the SD CARD.

*The SD Card and the USB Flash Drive can be used at the same time but only one can be selected at a time; select the active one using the OK button while row 1 is highlighted.

ROW 2. Formatting utility; use the OK button to format the selected device.

This symbol  on row 2 is for formatting the USB Flash storage device.

This symbol  on row 2 is for formatting the SD CARD.

This symbol  is shown on the screen during formatting and the symbol  appears when formatting completed.

Note: The duration of formatting depends on the memory size of the storage device.

ROW 3. Return to main menu with OK button press

RETURN symbol  in row 3; Press the OK button to return to the main menu.



9.2 Set DATE/TIME and AUTO POWER OFF Time

From the main menu, use the arrow buttons to scroll to the Date/Time icon and press OK to open it. There are three rows of selections in this menu.

ROW 1 (top). Set the year, month, and day. Use the up and down arrow buttons to select the year, month, or day field (digits highlight when selected) and use the PHOTO (decrement) and VIDEO (increment) buttons to set the date.

ROW 2. Set the clock (hours, minutes, and seconds). Use the up and down arrow buttons to select the hours, minutes, or seconds field and use the PHOTO and VIDEO buttons to set the time.

ROW 3. Auto Power Off can be set to 30, 25, 20, 15, 10, 5 or 0 minutes (center digits)

Selecting the symbol  will change the symbol color to red  which disables the Auto Power Off utility.

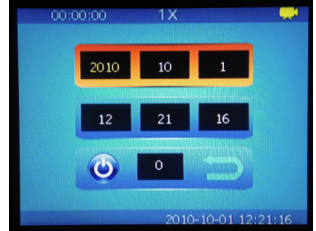

9.3 AV Output Selections

- From the main menu, use the arrow buttons to scroll to the AV Output icon and press OK to open it.
- Connect the Phone plug end of the AV cable to the AV Output port (6) of the Main Unit and connect the RCA connectors to the external monitor, respectively.
- Use the arrow buttons to highlight the desired output signal type (PAL or NTSC) and press OK to begin sending the output signal to the remote monitor. The display will exit the programming mode and return to the main operating display.
- Use the ESC key to abort the output selection process, if desired, and return to the programming main menu.

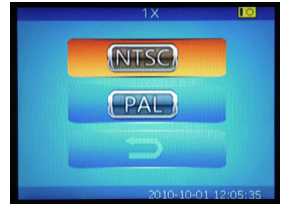

9.4 Factory Default Reset and Firmware Version

- From the main menu, use the arrow buttons to scroll to the Factory Default icon and press OK to open it.
- There are three rows of options in this menu: Top row is the factory default reset icon (to revert to factory default settings: highlight this icon with the arrow buttons and activate with the OK button).
- The middle row is the abort function. Press OK with the RETURN symbol highlighted to return to the main function menu.
- The bottom row shows the firmware version number.

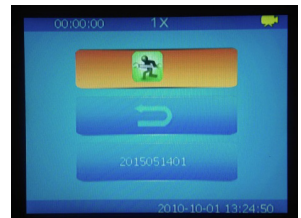

9.5 Image and Video Files



Use this menu to view the stored images and videos on the main unit display.

- From the main menu, use the arrow buttons to scroll to the File Management icon and press OK to open it.
- Use the up and down arrow buttons to scroll through the available image and video storage folders and files. Folder names are derived from the Date (e.g. 20100930) and the file names are derived from the Date and Time (e.g. 20150603153843).
- Press the OK button to open a folder or file.

Folder and File Symbols:



Folder



Video in AVI format



Photo in jpg format

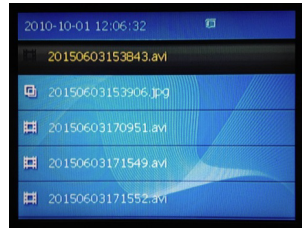

- Use the arrow buttons to highlight an image or video and press OK to view it.
- For video, use the arrow buttons (short press) to restart video, long presses of the arrow buttons fast-forward (up arrow) or fast-rewind (down arrow); use the OK button to Pause/Resume.
- Use the VIDEO button (2) to open the trash utility. Use an arrow button to highlight the check mark (delete) or the 'X' (keep video); press OK to complete the function.

Tip: Enter the image or video review mode from the main operating display by pressing the up arrow button without having to access this function menu. Use the arrow buttons to scroll the folders and files and use the OK button to open an image or video. Restart, fast forward/rewind, trash, and pause/resume functions operate in the same way as described in this section.

10. Maintenance

10.1 Cleaning

The system is supplied with a lens cloth and lens swabs for cleaning the camera lens. A damp cloth can be used to wipe the main unit and the camera snake. Do not use abrasives or solvents to clean any part of the system.

10.2 Battery Replacement

The internal rechargeable battery is not user serviceable. Please contact Extech for replacement services.

11. Specifications

HD VideoScope monitor	HDV500
Camera assembly	Model: HDV5-6CAM-1AFM
Display	8.9cm (3.5 in.) TFT monitor 320 x 240 pixels (HDV500)
Camera Connector	M12 (5 pin)
Recording medium	SD Card 2~32GB, SDHC compatible (32G max. Class-10); 4GB supplied
Image (photo) storage format	JPEG (640 x 480)
Image zoom	10x in photo image view mode
Storage capacity	Up to 20,000 images or 6 hours of video on 4GB SD Card
Interface	Mini USB 2.0
	AV (audio-visual) output to external monitor
Video file formats	MPEG4 / AVI
Video output formats	NTSC & PAL
Frame rate	30 fps (frames per second)
Compression format	MPEG4/CVBS
Video file size	120 min. = 1.4 GB
Camera Zoom	4x
Camera resolution	640 x 480 pixels
Camera cable length	1m (3.3')
Camera Outer diameter O.D.	6mm (0.24")
Camera focal distance	2 to 6cm (0.79 to 2.36")
Camera bend radius	240° articulation
Camera housing	Stainless Steel
Camera Field of View (FOV)	60°
Camera work lamps	Four (LED) lamps with intensity control (dial on left of main unit)
Camera work lamp output	3500 Lux @ 20mm (max.)
Total weight of main unit	400g (14.1 oz.) with battery
Dimensions of main unit	21 x 11 x 4cm (8.3 x 4.3 x 1.6 in.)
Operating temperature	Main unit: 0~50°C (32~122°F); Camera: -20~70°C (-4~158°F)
Storage temperature	Main unit: 0~50°C (32~122°F); Camera: -20~70°C (-4~158°F)
Battery	Rechargeable Li-Polymer battery 3.7 (V); not user-serviceable
Power adapter	Universal AC Adaptor VAC 100~240V, 50~60Hz, 0.3A Max. DC 5V, 2.5A, 12.5W
Battery life and charge time	4 hour battery life; Charging time 5 hours @ 25°C (77°F)
Power consumption	340mA / 5 V
IP Rating	IP67 (compact, high resolution water-proof camera probe)

Copyright © 2015 FLIR Systems, Inc.

All rights reserved including the right of reproduction in whole or in part in any form

ISO-9001 Certified

www.extech.com