

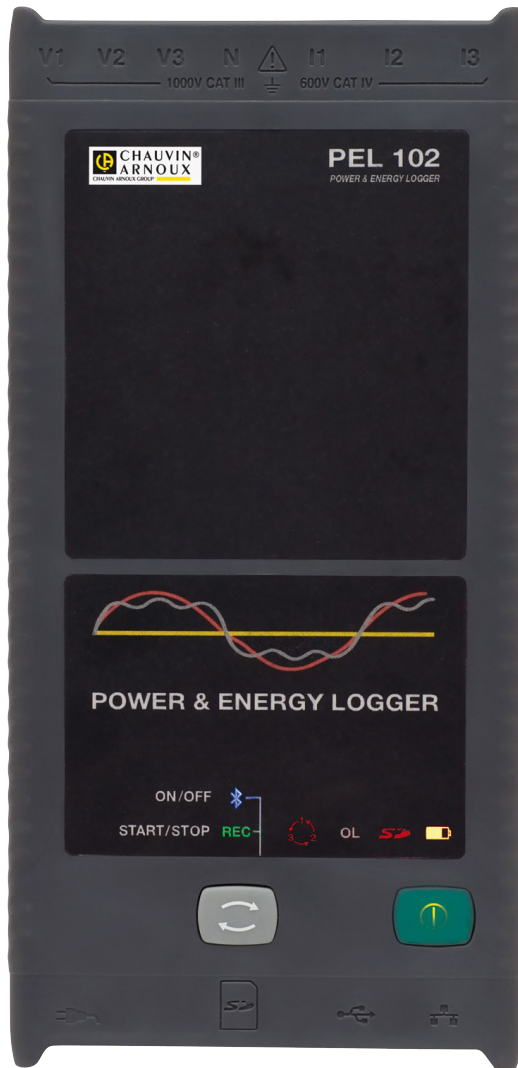













POWER ENERGY LOGGER

PEL102
PEL103



Thank you for purchasing a **Power & Energy Logger PEL102 or PEL103**. To obtain the best service from your unit:

- **read** these operating instructions carefully,
- **comply** with the precautions for use.

	WARNING, risk of DANGER! The operator must refer to these instructions whenever this danger symbol appears.
	Equipment protected by double insulation.
	USB socket.
	Ethernet socket (RJ45).
	SD Card.
	Main power supply input.
	Kensington anti-theft system.
	Earth.
	Important instructions to read and to fully understand.
	Useful information or tip to read.
	The product has been declared recyclable after analysis of its life cycle in accordance with the ISO14040 standard.
	The CE marking indicates conformity with European directives, in particular LVD and EMC.
	The rubbish bin with lines through it indicates that, in the European Union, the product must undergo selective disposal in compliance with Directive WEEE 2002/96/EC. This equipment must not be treated as household waste.

Definition of measurement categories:

- Measurement category IV corresponds to measurements taken at the source of low-voltage installations.
Example: power feeders, meters and protection devices.
- Measurement category III corresponds to measurements on building installations.
Example: distribution panel, circuit-breakers, machines or fixed industrial devices.
- Measurement category II corresponds to measurements taken on circuits directly connected to low-voltage installations.
Example: power supply to domestic electrical appliances and portable tools.

PRECAUTIONS FOR USE

This instrument complies with safety standard IEC 61010-2-030, the leads comply with IEC 61010-031 for voltages of 1000 V in measurement category III or 600 V in measurement category IV and the current sensors comply with IEC 61010-2-032. Failure to observe the safety instructions may result in electric shock, fire, explosion, and destruction of the instrument and of the installations.

- The operator and/or the responsible authority must carefully read and clearly understand the various precautions to be taken in use. Sound knowledge and a keen awareness of electrical hazards are essential when using this instrument.
- For your safety, use only the compatible leads and accessories delivered with the instrument. When sensors or accessories having a lower voltage rating and/or category are connected to the instrument, the lower voltage and/or category applies to the system so constituted.
- Before each use, check that the leads, enclosures, and accessories are in perfect condition. Any lead, sensor or accessory on which the insulation is damaged (even partially) must be repaired or scrapped.
- Do not use the instrument on networks of which the voltage or category exceeds those mentioned.
- Do not use the instrument if it seems to be damaged, incomplete, or poorly closed.
- Use only the AC power adapter supplied by the manufacturer.
- When removing and replacing the SD-Card, make sure that the device is disconnected and switched off.
- We recommend using Personal Protection Equipment where required.
- Keep your hands away from unused terminals.
- If the instrument is wet, dry it before connecting it.
- All troubleshooting and metrological checks must be performed by competent and accredited personnel.

CONTENTS

1. GETTING STARTED	4
1.1. Unpacking	4
1.2. Charging the battery	5
2. PRODUCT FEATURES	6
2.1. Description	6
2.2. Front Panel Features	7
2.3. Back Panel Features	8
2.4. Lead Inputs	8
2.5. Installation of the colour-coded markers	9
2.6. Connection Features	9
2.7. Mounting	10
2.8. Theft prevention	10
2.9. Button Functions	10
2.10. LCD Display (PEL 103)	11
2.11. LED Status	12
2.12. Memory Capacity	13
3. OPERATION	14
3.1. Turning the Instrument ON/OFF	14
3.2. Starting/Stopping a Recording and Enabling Bluetooth	14
3.3. Connections	15
3.4. Distribution Systems and PEL Hook-ups	17
3.5. Display Modes (PEL 103)	22
4. PEL TRANSFER SOFTWARE	36
4.1. Installing PEL Transfer	36
4.2. Connecting to a PEL	39
4.3. Configuring the PEL	45
4.4. PEL Transfer	51
4.5. Downloading Recorded Instrument Data	53
5. SPECIFICATIONS	54
5.1. Reference Conditions	54
5.2. Electrical Specifications	54
5.3. Bluetooth	64
5.4. Power Supply	64
5.5. Mechanical Specifications	65
5.6. Environmental Specifications	65
5.7. Safety Specifications	65
5.8. Electromagnetic Compatibility	65
6. MAINTENANCE	66
6.1. Battery	66
6.2. Battery Indicator	66
6.3. Cleaning	66
6.4. Metrological check	67
6.5. Repair	67
6.6. Updating of the internal software	67
7. WARRANTY	68
8. TO ORDER	69
8.1. PEL102/103 Power & Energy Logger	69
8.2. Accessories	69
8.3. Spare parts	69
9. APPENDIX	70
9.1. Measurements	70
9.2. Measurement Formulas	72
9.3. Aggregation	73
9.4. Supported Electrical Networks	74
9.5. Quantities According to the Supply Systems	76
9.6. Glossary	78

1. GETTING STARTED

1.1. UNPACKING

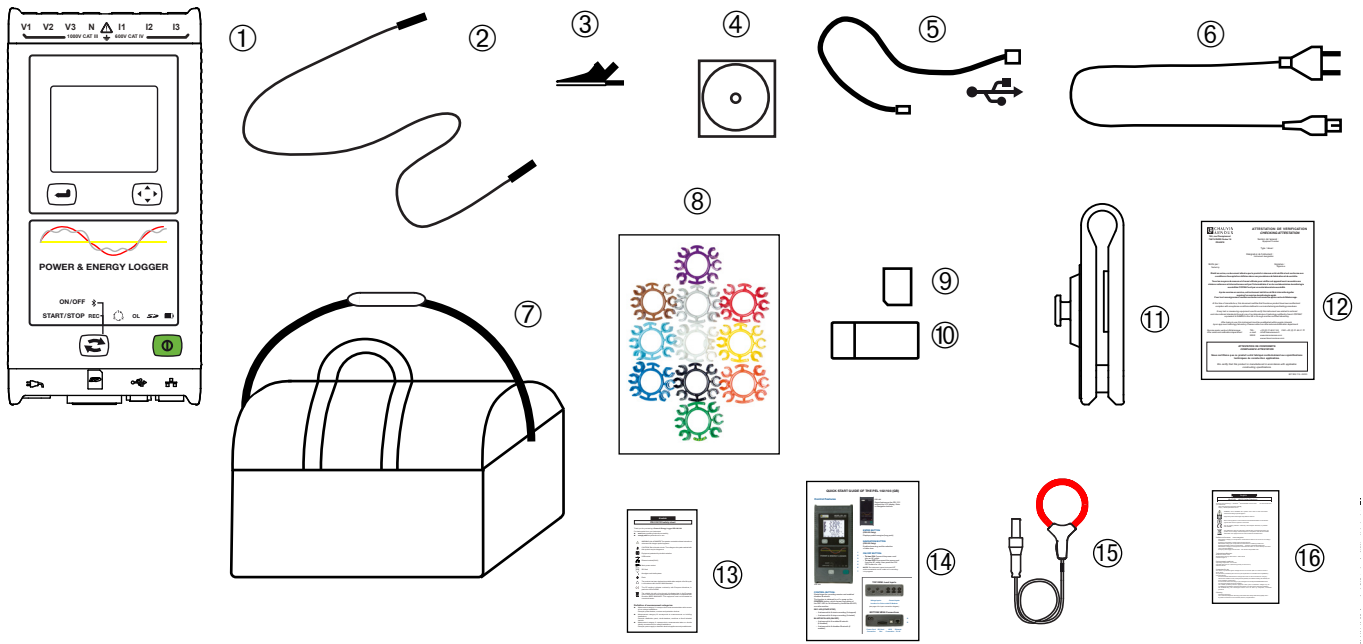

Figure 1

No.	Designation	Quantity
①	PEL102 or PEL103 (depends on the model).	1
②	Black safety leads, 3m, banana-banana, straight-straight attached by a Velcro tie.	4
③	Black crocodile clips.	4
④	CD with user's manuals and PEL Transfer software.	1
⑤	Type A-B USB cord 1.5m.	1
⑥	Mains cord 1.5m.	1
⑦	Carrying bag.	1
⑧	Set of inserts and rings for marking the leads and current sensors according to phase.	12
⑨	8 GB SD-card (in the instrument).	1
⑩	USB SD-Card adapter.	1
⑪	MultiFix (universal mounting system).	1
⑫	Checking attestation.	1
⑬	PEL safety sheet.	1
⑭	Quick start guide.	15
⑮	MA193 MiniFLEX® Current Sensors (depends on the model).	3
⑯	MA193 clamp safety sheet (depends on the model).	1

Table 1

1.2. CHARGING THE BATTERY

Before the first use, start by fully charging the battery at temperatures between 0 and 40°C.

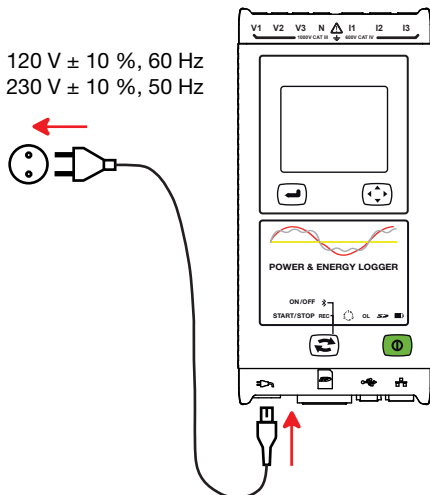

Connect the mains cord to the device and to mains.

The device turns on.

The  LED lights; it will go out only when the battery is fully charged.

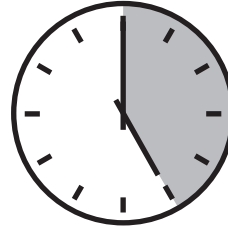

Charging a discharged battery takes approximately 5 hours.



After prolonged storage, the battery may be completely discharged. If so, the  LED blinks twice per second. In this case, at least 5 charge/discharge cycles will be necessary for your battery to recover 95% of its capacity.

2. PRODUCT FEATURES

2.1. DESCRIPTION

PEL: Power & Energy Logger

The PEL 102/103 are simple-to-use single-, dual-, and three-phase (Y, Δ) Power & Energy Loggers.

The PEL offers all necessary functions for Power/Energy data logging for most 50 Hz, 60 Hz, 400 Hz and DC distribution systems worldwide, with many connection possibilities. The PEL is designed to work in 1000 V CAT III and 600 V CAT IV environments.

The PEL is compact and can be incorporated in many distribution panels.

The PEL provides the following measurements and calculations:

- Direct measurements of voltages up to 1000 V CAT III and 600 V CAT IV
- Direct measurements of current from 50 mA up to 10 000 A with MA193 external current sensors
- Power measurements: active (W), reactive (var) and apparent (VA)
- Energy measurements: active (source and load (Wh)), reactive 4 quadrants (varh) and apparent (VAh)
- Power Factor (PF), $\cos \varphi$, and $\tan \Phi$
- Crest Factor
- Total Harmonic Distortion (THD) for voltages and currents
- Harmonics from the fundamental signal up to the 50th order for 50/60 Hz voltages and currents
- Frequency measurements
- RMS and DC measurements @ 128 samples/cycle – all phases simultaneously
- Bright white triple LCD display on PEL 103 (3 phases shown simultaneously)
- Storage of measured and calculated values on an SD-Card or SDHC-Card
- Automatic recognition of the different types of current sensors
- Configuration of current and voltage ratios with external sensors
- Supports 17 types of connections or electrical distribution systems
- USB, LAN, and Bluetooth communication
- PEL Transfer software for data recovery, configuration and real-time communication with a PC

2.2. FRONT PANEL FEATURES

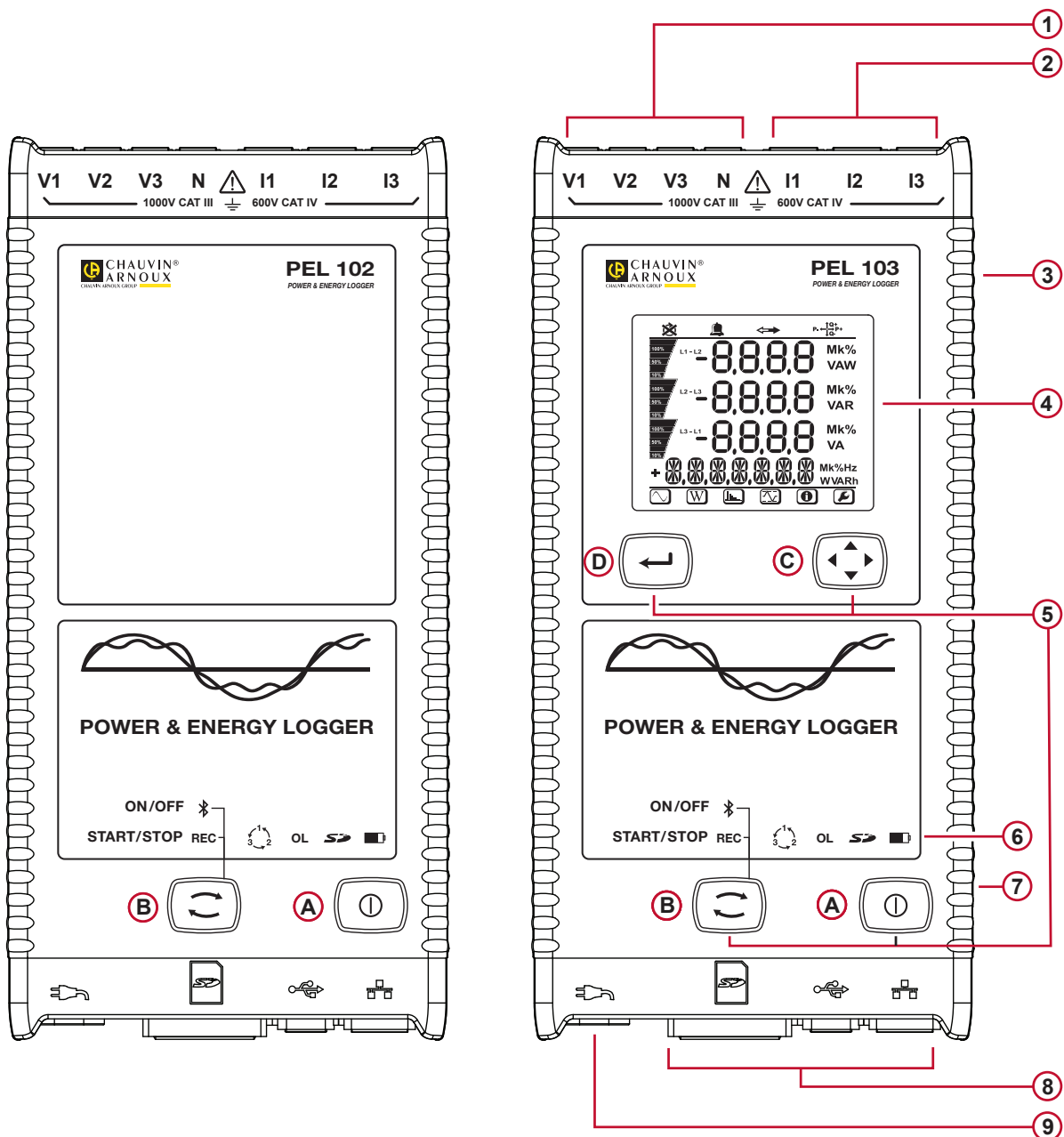

Figure 3

- ① Four terminals for voltage test leads.
- ② Three terminals for current sensors.
- ③ Rigid molded elastomer casing.
- ④ Digital LCD displaying measured, calculated and parameterizing quantities (see § 2.10).
- ⑤ Two (PEL102) or four (PEL103) function buttons (see § 2.9).
 - Ⓐ ON/OFF button
 - Ⓑ Control button
 - Ⓒ Navigation button
 - Ⓓ Enter button
- ⑥ Nine LEDs for status information (see § 2.11).
- ⑦ Anti-theft Kensington Security Slot (see § 2.8).
- ⑧ USB and Ethernet connectors, SD memory card slot and connector caps.
- ⑨ Standard non-polarized IEC C7 power connector for 110/230 V_{AC} power source.

2.3. BACK PANEL FEATURES

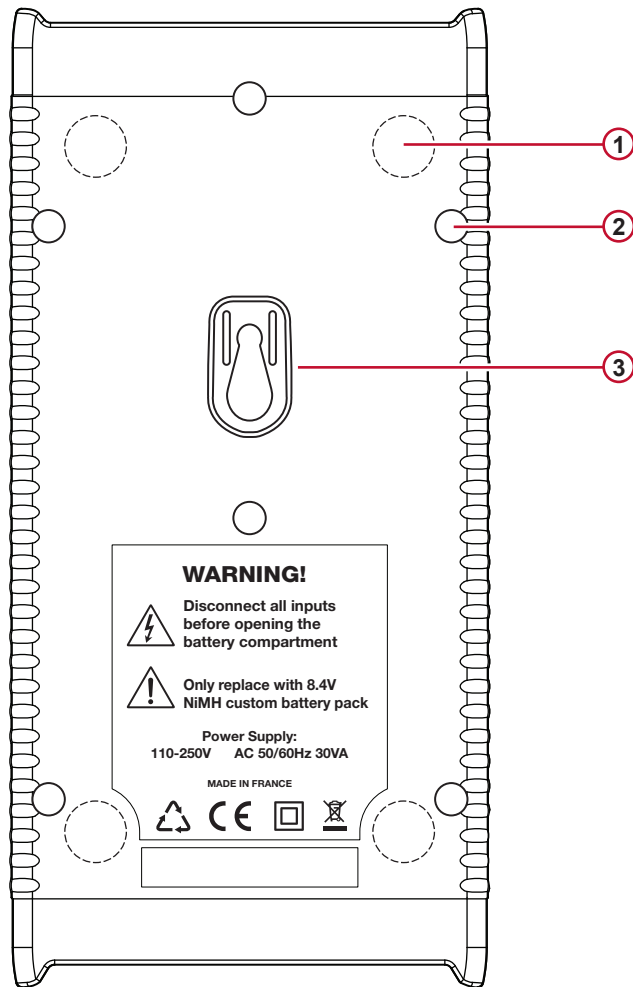

Figure 4

- ① Four magnets (molded into the rubber casing).
- ② Six recessed Torx® screws (for factory service use only)
- ③ Slot for MultiFix accessory (see § 2.7).

2.4. LEAD INPUTS

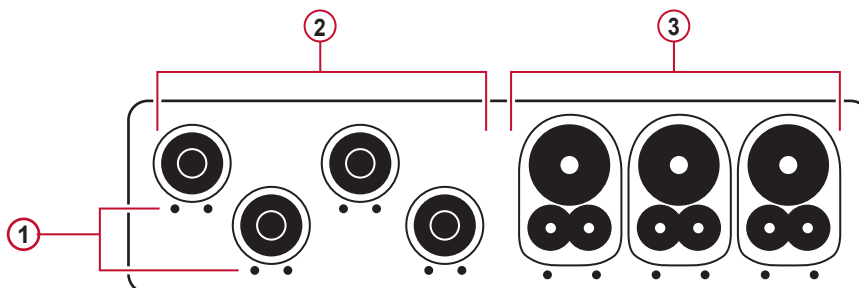

Figure 5

- ① The small holes (••) are for the color-coded inserts used to identify the current and voltage inputs.
- ② Voltage input terminals (safety banana plug inputs).
- ③ Current input terminals (specific four-point jacks).

For multiple-phase measurements, start by marking the accessories and terminals with the colour-coded ID markers supplied with the device; a different colour for each terminal.

Connect the measuring leads to your PEL as follows:

- Current measurement: I1, I2, I3 4-pins terminals
- Voltage measurement: V1, V2, V3 and N terminals

The measuring leads must be connected to the circuit to be monitored according to the selected hook-up diagram. Do not forget to define the current and voltage transformer ratios when necessary.

2.5. INSTALLATION OF THE COLOUR-CODED MARKERS

! Refer to the current sensors safety sheets before connecting them.

Twelve sets of colour-coded rings and inserts are supplied with your PEL instrument. Use them ID markers to identify the leads and input terminals.

- Detach the appropriate inserts and place them in the holes under the terminals (larger inserts for current terminals, smaller inserts for voltage terminals).
- Clip rings of the same colour to the ends of the lead you will be connecting to the terminal.

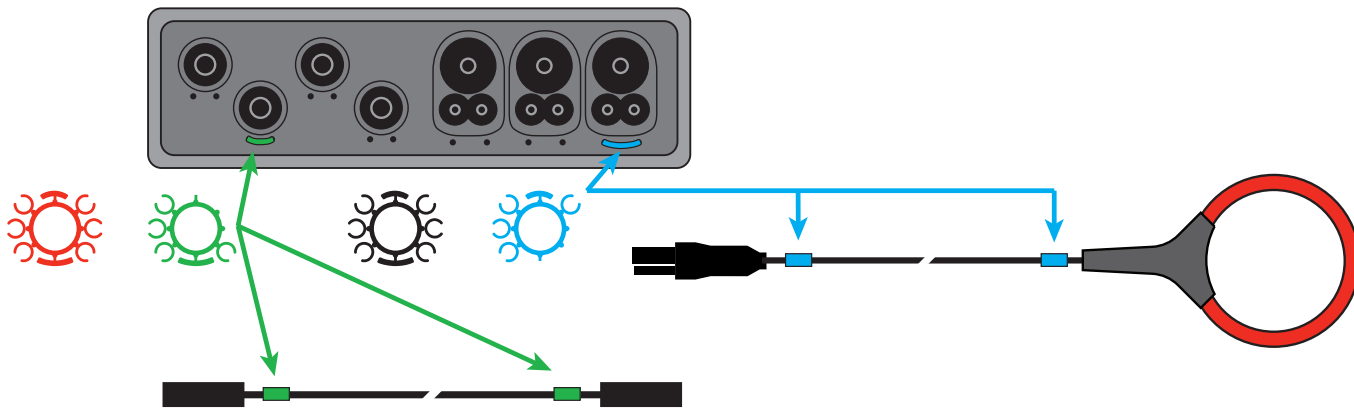

Figure 6

2.6. CONNECTION FEATURES

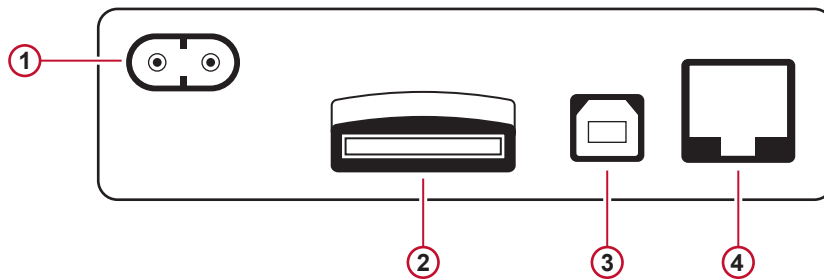

Figure 7

- ① Power cord connection (see § 3.3.1).
- ② SD card slot (see § 3.3.3).
- ③ USB connector (see § 3.3.4).
- ④ Ethernet RJ 45 connector (see § 3.3.6).

2.7. MOUNTING



The strong magnetic field can damage your hard drives or medical devices.

The PEL should be placed in a well-ventilated room. Temperature should not exceed the values specified in § 5.6.

The PEL 102/103 can be mounted on a flat ferromagnetic vertical surface using the built-in magnets.

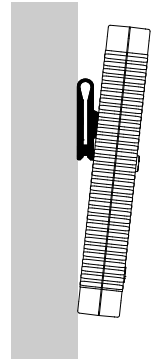

Figure 8

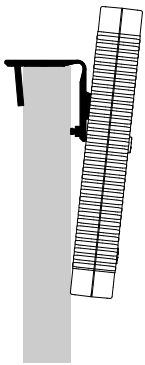

Figure 9

The PEL 102/103 can also be mounted to a flat vertical surface using the MultiFix multi-purpose mounting accessory (see #11 in Table 1).

The MultiFix is equipped with a powerful magnet for ferromagnetic surfaces and a double-jointed hinge for “door-top” mounting (hanging from the top of the doors) or hanging on hooks.

2.8. THEFT PREVENTION

The PEL102/103 is equipped with a Kensington Security Slot (see #7 in Figure 3) for use with a locking cable to protect your instrument from theft (locking cables available from office and computer supply stores).

2.9. BUTTON FUNCTIONS

Button	Description
	ON/OFF button: Turns the instrument ON or OFF (see § 3.1). Note: The instrument cannot be turned OFF while connected to an AC outlet or if a recording is in progress.
	Control button: Starts/Stops the recording session and Enables/Disables Bluetooth (see § 3.2).
	Enter button (PEL103): Displays phase angles values and partial energies (see § 3.5.1 and 3.5.2).
	Navigation button (PEL103): Enables browsing and the selection of data displayed on the LCD screen (see § 3.5).

Table 2

2.10. LCD DISPLAY (PEL 103)

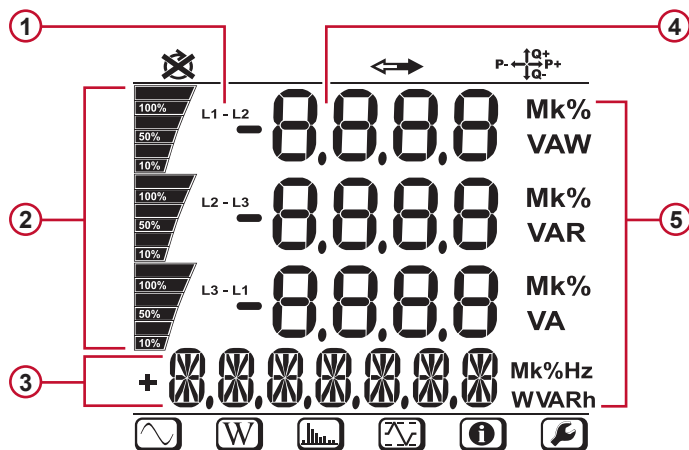

Figure 10

- ① Phase
- ② Indicates the percentage (0% to 100%) of the full range or full load programmed in the PEL by the user via the PEL Transfer[®] software.
- ③ Measurements or display page titles
- ④ Measured values
- ⑤ Measurement units

The top and bottom bars indicate the following:

Icon	Description
	Phase Sequence reversal or missing phase indicator (displayed only in Measurement Mode, see explanations below)
	Data are available for recording (non-display indicates possible internal problem)
	Indication of the power quadrant (see §9.1)
	Measurement Mode (Real Time values) (see §3.5.1)
	Power and Energy Mode (see §3.5.2)
	Harmonics Mode (see §3.5.3)
	Max Mode (see §3.5.4)
	Information Mode (see §3.5.5)
	Set-up (see §3.5.6)

Table 3

Phase order

The phase order icon is displayed on the LCD only when Measurement Mode is selected.

The phase order is determined every second. If the phase order is incorrect, the symbol is displayed on the LCD display.

- Phase order for voltage channels only is displayed when voltages are displayed on measurement screen.
- Phase order for current channels only is displayed when currents are displayed on measurement screen.
- Phase order for voltage and current channels is displayed when the other screens are displayed.
- Source and load shall be set to define the direction of energy (import or export), see § 4.3.3.

2.11. LED STATUS

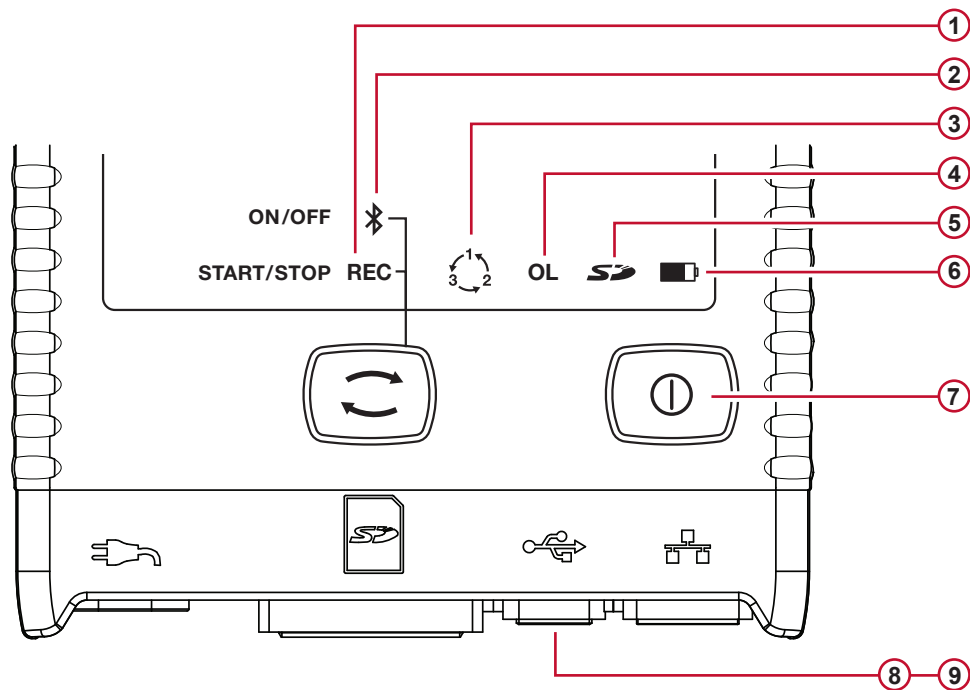

Figure 11

LED & Colour	Status
①	Green LED: Recording Status LED blinks once per second every 5 s: Logger in standby (not recording) LED blinks twice per second every 5 s: Logger in recording mode
②	Blue LED: Bluetooth LED OFF: Bluetooth OFF (disabled) LED ON: Bluetooth ON (enabled - not transmitting) LED blinks twice per second: Bluetooth ON (enabled - transmitting)
③	Red indicator: Phase order OFF: the order of phase rotation is correct. LED blinks once per second: the order of phase rotation is incorrect. In this case, there are three possibilities: <ul style="list-style-type: none"> ■ the phase difference between the phase currents is 30° greater than normal (120° in three-phase and 180° in two-phase). ■ the phase difference between the phase voltages is 10° greater than normal. ■ the phase difference between the currents and voltages of each phase is 60° greater than 0° (load) or 180° (source).
④	Red LED: Overload OFF: No overload on inputs LED blinks once per second: At least one input is overloaded LED ON: Indicates that a current probe is either misconnected or missing
⑤	Red/Green LED: SD-Card Status Green LED ON: SD-Card is OK Red LED blinks five times every 5 s: SD-Card is full Red LED blinks four times every 5 s: less than 1 week capacity remaining Red LED blinks three times every 5 s: less than 2 weeks capacity remaining Red LED blinks twice every 5 s: less than 3 weeks capacity remaining Red LED blinks once every 5 s: less than 4 weeks capacity remaining Red LED ON: SD-Card is missing or locked

LED & Colour	Status
<p>⑥</p>	<p>Yellow/Red LED: Battery Status When the AC power cord is connected, the battery charges until it is full. LED OFF: Battery full Yellow LED ON: Battery is charging Yellow LED blinks once per second: Battery is recovering from a full discharge Red LED blinks twice per second: Low battery (and no power supply)</p>
<p>⑦ under ON/OFF button</p>	<p>Green LED: ON/OFF LED ON: External power supply present LED OFF: No external power supply</p>
<p>⑧ embedded in the connector</p>	<p>Green LED: Ethernet LED OFF: No activity LED blinks: Activity</p>
<p>⑨ embedded in the connector</p>	<p>Yellow LED: Ethernet LED OFF: The stack failed to initialize or the Ethernet controller failed to initialize Slow blinking (once a second): The stack initialized properly Rapid blinking (10 times per second): The Ethernet controller initialized properly Blinks twice, then pause: DHCP Error LED ON: Network initialized and ready for use</p>

Table 4

2.12. MEMORY CAPACITY

The PEL accepts FAT32 formatted SDHC cards up to 32GB in size. Transferring so much data makes heavy demands on a computer and requires a long download time (depending on the performance of the PC and the type of connection used). Furthermore, some computers may have problems handling such a large amount of data and spreadsheets accept only a limited amount of data.

We recommend optimizing the data on the SD card and recording only what is needed. For reference purposes, a 5-day recording, with a 15 minute aggregation interval, recording 1-second data and harmonics on a 4-wire 3-phase network, would consume approximately 530MB of storage space. If the harmonics are not needed and their recording is disabled, the space requirement is reduced to about 87MB.

The recommended maximum recording times are:

- seven days when the recording includes the aggregated values, 1-second data, and harmonics;
- one month when the recording includes the aggregated values and 1-second data but not the harmonics;
- one year when the recording contains only the aggregated values.

Also avoid exceeding 32 recorded sessions on the SD card.



Note: For recordings with harmonics or with a duration longer than one week, please use class 4 or higher SDHC cards.

We recommend not using Bluetooth to download large sessions as it will take a very long time. If a Bluetooth download is required, consider not downloading the 1-second trends and harmonics. Without them, a 30 day recording would be reduced to just 2.5 MB.

By contrast, downloading via USB or Ethernet may be acceptable depending on the session size and network speed. For faster downloads, we recommend putting the SD card into your PC directly or the external card reader.

3. OPERATION



Important: PEL configuration can be performed either through the PEL or either through the PEL Transfer software. Please refer to § 4.3 for setup instructions.

Operating the PEL is a simple process:

- The PEL must be programmed before any recording. This is done through Set-up (see §3.5.6) or the PEL Transfer (see § 4.3). To prevent inadvertent changes to settings, the PEL cannot be programmed while recording.
- The PEL is then connected to a power supply and will turn on automatically (see § 3.1.1).
- Recording is started by pressing the **Control** button  (see § 3.2).
- The PEL is turned OFF, after a specified time, when disconnected from the power supply (and when the recording session is completed - see § 3.1.2).

3.1. TURNING THE INSTRUMENT ON/OFF

3.1.1. TURNING ON

- Connect the PEL to a power outlet with the AC power cord and the PEL will turn ON automatically. If not, press the **ON/OFF** button for more than 2 seconds.
- The green LED under the **ON/OFF** button turns ON when the PEL is connected to a live supply source.



Note: The battery automatically begins recharging when the PEL is connected to a live power outlet. Battery life is approximately 1/2 hour when the battery is fully charged, enough to cover brief power outages.

3.1.2. TURNING THE PEL OFF

You cannot turn the PEL OFF if it is connected to a power source or if a recording is in progress (or pending).

Note: This is a precaution to ensure that the PEL is not accidentally turned OFF when recording and to ensure that the PEL turns on when the power supply is turned back on after an outage.

To turn the PEL OFF:

- Unplug the cord from the power outlet.
- Press the **ON/OFF** button for more than 2 seconds, until all LEDs turn on. Then release the **ON/OFF** button.
- All LEDs and the display will turn off as the PEL powers down.
- If the PEL has supply power present, it will not turn OFF.
- If a recording is pending or in progress, it will not turn OFF.

3.2. STARTING/STOPPING A RECORDING AND ENABLING BLUETOOTH

Recordings are stored only on the SD card.

To Start a Recording:

- Insert the SD-card into the PEL.
- Use the **Control** button  to start or stop a recording session and to enable or disable Bluetooth.
- Press the **Control** button more than 2 seconds and release it.
- The green REC LED (see #1 Figure 11) lights up for 3 s, followed by the blue Bluetooth LED (see #2 Figure 11) for 3 s - one after another. During the time each LED is lit you can control its associated function as described below.
- Releasing the **Control** button during (and only during) the 3 s lighting of a particular LED performs the associated function:
 - **REC LED (START/STOP)**
 - A release while LED is lit Starts a Recording (if recording is OFF)
 - A release while LED is lit Stops a Recording (if recording is ON)

■ BLUETOOTH LED (ON/OFF)

- A release while LED is lit turns Bluetooth ON (if Bluetooth is OFF)
- A release while LED is lit turns Bluetooth OFF (if Bluetooth is ON)



Note: If you want to make changes to both the Recording and Bluetooth, you need to go through the process twice.

3.3. CONNECTIONS

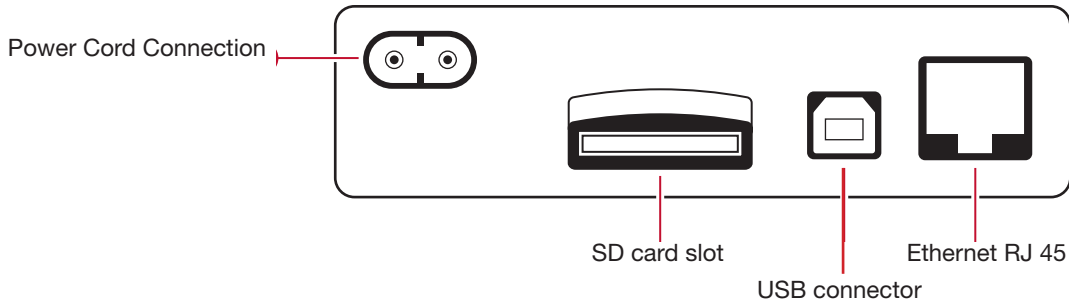

Figure 12

3.3.1. POWER SUPPLY

The PEL is powered by standard AC power through an external cord with a non-polarized C7 connector. This power cord is available in many computer stores (250 V, 2.5 A, 1 m length). When replacing it, be sure to buy the non-polarized cord. Replacement power cords are also available from the factory.

The PEL can be supplied at 110 V to 250 V ($\pm 10\%$), 50/60 Hz, to accommodate supply voltages across the world.



Note: Never use power cords with inadequate rating.

- When connected to AC power, the instrument is always ON.
- Applying AC power to the PEL turns the instrument ON if it was OFF and starts recharging the batteries automatically.
- If the instrument is suddenly not powered by AC power (power supply OFF or disconnected), the instrument will run on battery power for approximately ½ hour.
- The PEL has a built-in Auto Power OFF. It can be set to 3 to 15 min or disabled.
- When the battery is too low (the red LED  blinks twice per second), the instrument will eventually turn OFF. The PEL will start up again when AC power is turned back on.
- When the instrument is not connected to AC power, it can be turned ON with the **ON/OFF** button (see § 3.1).
- When the instrument is not connected to AC power and no recording is pending or in progress, it can be turned OFF with the **ON/OFF** button (see § 3.1).

3.3.2. STANDBY MODE (AND DISPLAY BRIGHTNESS)

When the instrument is ON and there is no activity for a specified time period, the LCD display (PEL103) automatically goes into Standby mode.

The measurements and recording stay active, but the backlighting is dimmed to a standby level.

To restore the normal display unit brightness, press the **Enter** or **Navigation** button.

Note that the overall display brightness is also programmed via the PEL Transfer (see § 4.3.1).

3.3.3. MEMORY CARD (SD-CARD)

The PEL 102/103 use an SD card for memory. FAT32-formatted SD-Cards (up to 32 GB) and SDHC-Cards (from 4 GB to 32 GB) are supported.

The PEL is delivered with a formatted SD card in the instrument. If you want to install a new SD card:

- First, format the SD card.
- The SD card can be formatted via PEL Transfer when connected to the instrument and if no recording is pending or in progress.
- Formatting is possible without restriction when the SD card is plugged directly into a PC.
- To allow recordings or formatting, the SD-Card must be unlocked.
- Hot extraction from the PEL is possible when no recording is in progress.

PEL files use short names (8 characters), for example Ses00004.

3.3.4. USB CONNECTION TO THE PEL

The PEL102/103 is designed to be connected to a computer by a USB type A/B cable, used to configure the PEL, prepare a recording session (real-time connection) and download recorded sessions.



Note: Connecting the USB between the PC and the PEL does not power the logger or recharge the batteries.

3.3.5. BLUETOOTH CONNECTION TO THE PEL

The PEL102/103 are designed for a Bluetooth wireless connection to a computer. The Bluetooth connection can be used to configure the PEL, to prepare a recording session and to download recorded sessions.

For computers without a Bluetooth capability, use a Bluetooth/USB adapter and connected to an available USB port on your computer. The default Windows driver should automatically install the device.

The pairing procedure varies depending on your operating system, Bluetooth equipment and driver software.

If needed, the default pairing code is **0000**. The pairing code can not be modified through the PEL Transfer.

3.3.6. ETHERNET LAN CONNECTION TO THE PEL

A LAN connection can be used to view real-time data and instrument status, configure the PEL, set up a recording session, and download recorded sessions.

IP address:

The PEL has an IP address. When the PEL is configured with the PEL Transfer, if the “Enable DHCP” (Dynamic Host Configuration Protocol) checkbox is checked, the instrument sends a request to the network DHCP server to automatically obtain an IP address. The Internet Protocol used is UDP. The default port is 3041. It can be modified with the PEL Transfer to let the PC connect to several PEL instruments behind a router.

An auto-IP mode is also available when DHCP is selected and no DHCP server is detected within 60 s. PEL will use default address 169.254.0.100. This auto-IP mode is compatible with APIPA. A cross over cable may be needed.



Note: Note that you cannot modify the LAN parameters while connected over a LAN link. You must use the USB connection to modify them.

3.4. DISTRIBUTION SYSTEMS AND PEL HOOK-UPS

This chapter describes how the current sensors and voltage test leads must be connected to your installation according to its distribution system. The PEL must also be configured (see § 4.3.3) for the selected distribution system.



3.4.1. SINGLE-PHASE 2-WIRE

For Single-Phase 2-Wire measurements:

- Connect the N test lead to the neutral conductor
- Connect the V1 test lead to the L1 phase conductor
- Connect the I1 current probe to the L1 phase conductor.

Check that the current arrow on the sensor points towards the load. This ensures proper phase angle for Power Measurements and other phase-sensitive measurements.

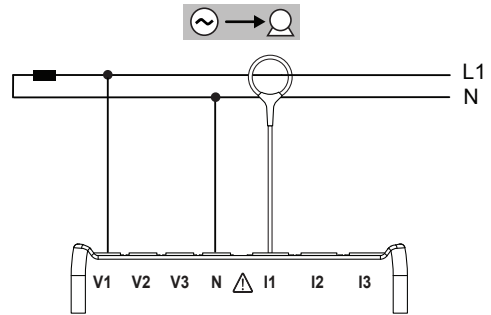

Figure 13

3.4.2. DUAL-PHASE (SINGLE-PHASE 3-WIRE FROM A CENTER TAP TRANSFORMER)

For Single-Phase 3-Wire (Split Phase) measurements:

- Connect the N test lead to the Neutral conductor
- Connect the V1 test lead to the L1 phase conductor
- Connect the V2 test lead to the L2 phase conductor
- Connect the I1 current probe to the L1 phase conductor.
- Connect the I2 current probe to the L2 phase conductor

Check that the current arrows on the sensors point towards the load. This ensures proper phase angle for Power Measurements and other phase-sensitive measurements.

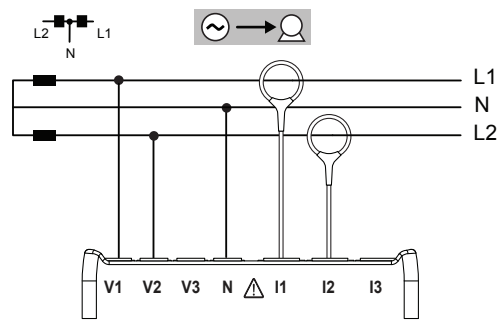

Figure 14

3.4.3. THREE-PHASE 3-WIRE POWER NETWORKS

3.4.3.1. 3-Phase 3-Wire Δ (with 2 current sensors)

For 3-phase 3-wire Δ measurements using two current sensors:

- Connect the V1 test lead to the L1 phase conductor
- Connect the V2 test lead to the L2 phase conductor
- Connect the V3 test lead to the L3 phase conductor
- Connect the I1 current probe to the L1 phase conductor.
- Connect the I3 current probe to the L3 phase conductor

Check that the current arrows on the sensors point towards the load. This ensures proper phase angle for Power Measurements and other phase-sensitive measurements.

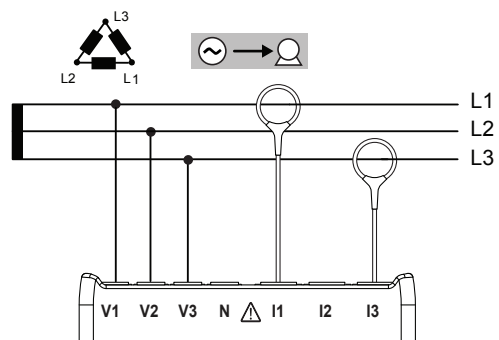

Figure 15

3.4.3.2. 3-Phase 3-Wire Δ (with 3 current sensors)

For 3-Phase 3-Wire Δ measurements using three current sensors:

- Connect the V1 test lead to the L1 phase conductor
- Connect the V2 test lead to the L2 phase conductor
- Connect the V3 test lead to the L3 phase conductor
- Connect the I1 current probe to the L1 phase conductor.
- Connect the I2 current probe to the L2 phase conductor
- Connect the I3 current probe to the L3 phase conductor

Check that the current arrows on the sensors point towards the load. This ensures proper phase angle for Power Measurements and other phase-sensitive measurements.

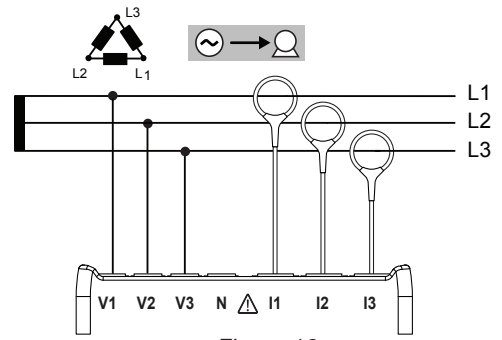

Figure 16

3.4.3.3. 3-Phase 3-Wire Open Δ (with 2 current sensors)

For 3-Phase 3-Wire Open Δ measurements using two current sensors:

- Connect the V1 test lead to the L1 phase conductor
- Connect the V2 test lead to the L2 phase conductor
- Connect the V3 test lead to the L3 phase conductor
- Connect the I1 current probe to the L1 phase conductor.
- Connect the I3 current probe to the L3 phase conductor

Check that the current arrows on the sensors point towards the load. This ensures proper phase angle for Power Measurements and other phase-sensitive measurements.

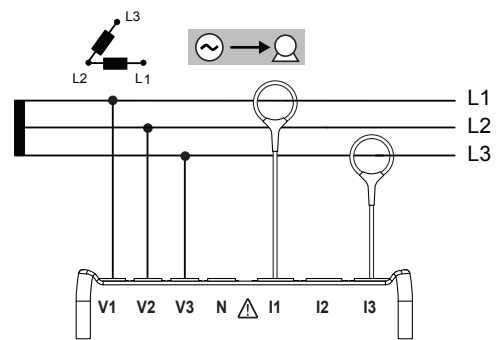

Figure 17

3.4.3.4. 3-Phase 3-Wire Open Δ (with 3 current sensors)

For 3-Phase 3-Wire Open Δ measurements using three current sensors:

- Connect the V1 test lead to the L1 phase conductor
- Connect the V2 test lead to the L2 phase conductor
- Connect the V3 test lead to the L3 phase conductor
- Connect the I1 current probe to the L1 phase conductor.
- Connect the I2 current probe to the L2 phase conductor
- Connect the I3 current probe to the L3 phase conductor

Check that the current arrows on the sensors point towards the load. This ensures proper phase angle for Power Measurements and other phase-sensitive measurements.

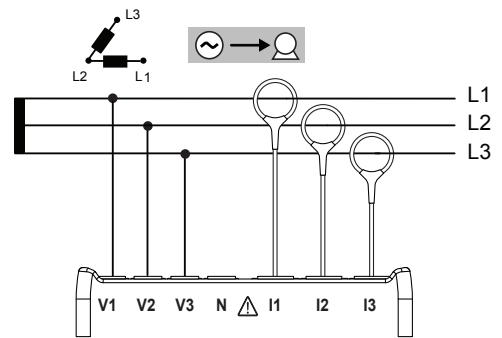

Figure 18

3.4.3.5. 3-Phase 3-Wire Y (with 2 current sensors)

For 3-Phase 3-Wire Y measurements using two current sensors:

- Connect the V1 test lead to the L1 phase conductor
- Connect the V2 test lead to the L2 phase conductor
- Connect the V3 test lead to the L3 phase conductor
- Connect the I1 current probe to the L1 phase conductor.
- Connect the I3 current probe to the L3 phase conductor

Check that the current arrow on the sensors point towards the load. This ensures proper phase angle for Power Measurements and other phase-sensitive measurements.

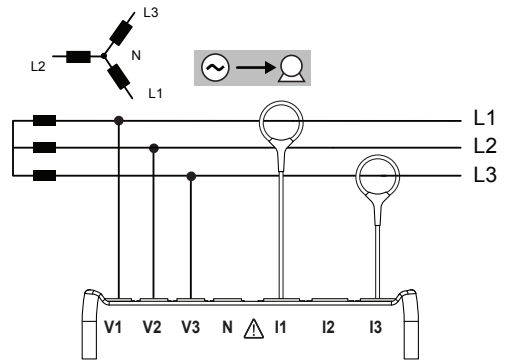

Figure 19

3.4.3.6. 3-Phase 3-Wire Y (with 3 current sensors)

For 3-Phase 3-Wire Y measurements using three current sensors:

- Connect the V1 test lead to the L1 phase conductor
- Connect the V2 test lead to the L2 phase conductor
- Connect the V3 test lead to the L3 phase conductor
- Connect the I1 current probe to the L1 phase conductor.
- Connect the I2 current probe to the L2 phase conductor
- Connect the I3 current probe to the L3 phase conductor

Check that the current arrows on the sensors point towards the load. This ensures proper phase angle for Power Measurements and other phase-sensitive measurements.

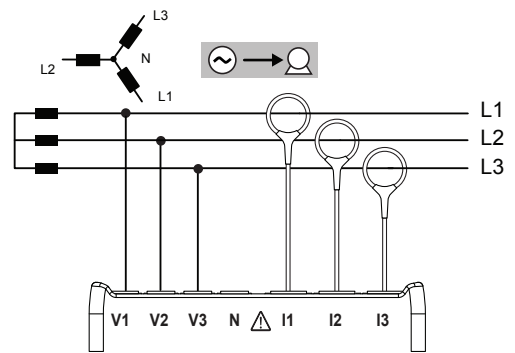

Figure 20

3.4.3.7. 3-Phase 3-Wire Δ Balanced (with 1 current sensor)

For 3-Phase 3-Wire Δ Balanced measurements using one current sensor:

- Connect the V1 test lead to the L1 phase conductor
- Connect the V2 test lead to the L2 phase conductor
- Connect the I3 current probe to the L3 phase conductor

Check that the current arrow on the sensor points towards the load. This ensures proper phase angle for Power Measurements and other phase-sensitive measurements.

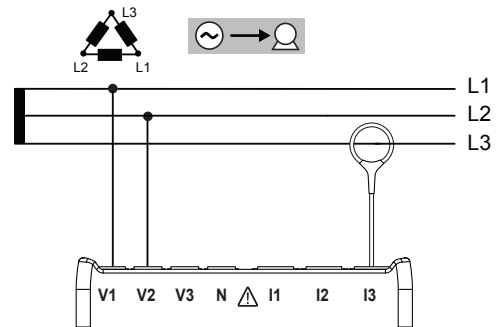

Figure 21

3.4.4. THREE PHASE 4-WIRE Y POWER NETWORKS

3.4.4.1. 3-Phase 4-Wire Y (with 3 current sensors)

For 3-Phase 4-Wire Y measurements using three current sensors:

- Connect the N test lead to the Neutral conductor
- Connect the V1 test lead to the L1 phase conductor
- Connect the V2 test lead to the L2 phase conductor
- Connect the V3 test lead to the L3 phase conductor
- Connect the I1 current probe to the L1 phase conductor.
- Connect the I2 current probe to the L2 phase conductor
- Connect the I3 current probe to the L3 phase conductor

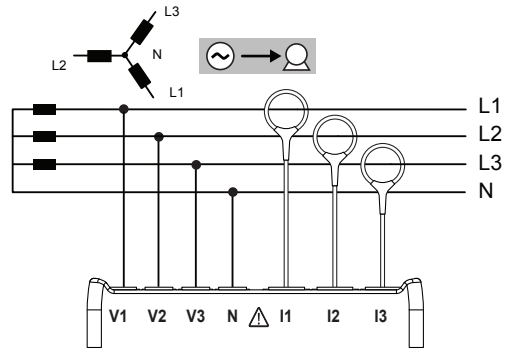

Figure 22

Check that the current arrows on the sensors point towards the load. This ensures proper phase angle for Power Measurements and other phase-sensitive measurements.

3.4.4.2. 3-Phase 4-Wire Y Balanced

For 3-Phase 3-Wire Balanced Y measurements using one current sensor:

- Connect the V1 test lead to the L1 phase conductor
- Connect the N test lead to the Neutral conductor
- Connect the I1 current probe to the L1 phase conductor

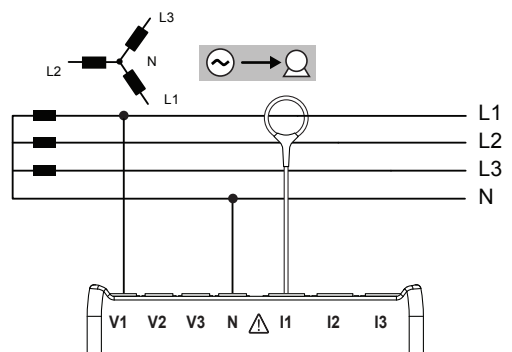

Figure 23

Check that the current arrow on the sensor points towards the load. This ensures proper phase angle for Power Measurements and other phase-sensitive measurements.

3.4.4.3. 3-Phase 4-Wire Y 2½ Element

For 3-Phase 4-Wire Y 2½ Element measurements using three current sensors:

- Connect the N test lead to the Neutral conductor
- Connect the V1 test lead to the L1 phase conductor
- Connect the V3 test lead to the L3 phase conductor
- Connect the I1 current probe to the L1 phase conductor.
- Connect the I2 current probe to the L2 phase conductor
- Connect the I3 current probe to the L3 phase conductor

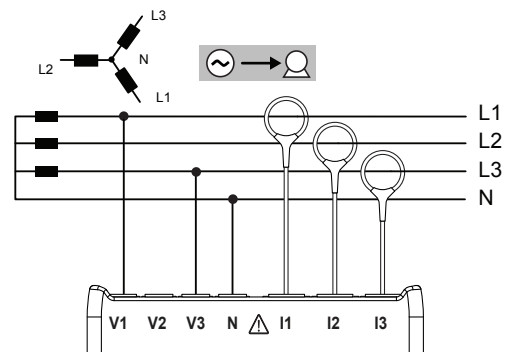

Figure 24

Check that the current arrows on the sensors point towards the load. This ensures proper phase angle for Power Measurements and other phase-sensitive measurements.

3.4.5. 3-PHASE 4-WIRE Δ

High Leg configuration. No Voltage Transformer is connected: the installation under test is assumed to be a low-voltage distribution system.

3.4.5.1. 3-Phase 4-Wire Δ

For 3-Phase 4-Wire Δ measurements using three current sensors:

- Connect the N test lead to the Neutral conductor
- Connect the V1 test lead to the L1 phase conductor
- Connect the V2 test lead to the L2 phase conductor
- Connect the V3 test lead to the L3 phase conductor
- Connect the I1 current probe to the L1 phase conductor.
- Connect the I2 current probe to the L2 phase conductor
- Connect the I3 current probe to the L3 phase conductor

Check that the current arrows on the sensors point towards the load. This ensures proper phase angle for Power Measurements and other phase-sensitive measurements.

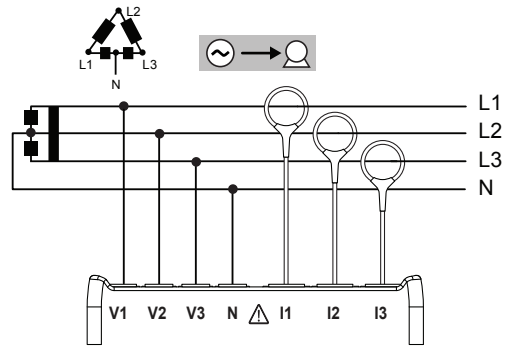

Figure 25

3.4.5.2. 3-Phase 4-Wire Open Δ

For 3-Phase 4-Wire Open Δ measurements using three current sensors:

- Connect the N test lead to the Neutral conductor
- Connect the V1 test lead to the L1 phase conductor
- Connect the V2 test lead to the L2 phase conductor
- Connect the V3 test lead to the L3 phase conductor
- Connect the I1 current probe to the L1 phase conductor.
- Connect the I2 current probe to the L2 phase conductor
- Connect the I3 current probe to the L3 phase conductor

Check that the current arrows on the sensors point towards the load. This ensures proper phase angle for Power Measurements and other phase-sensitive measurements.

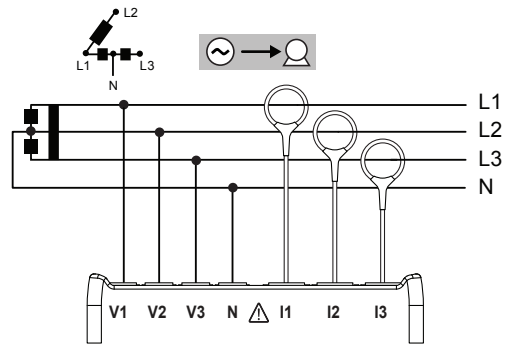

Figure 26

3.4.6. DC POWER NETWORKS

3.4.6.1. DC 2-Wire

For DC 2-Wire measurements:

- Connect the N test lead to the negative conductor
- Connect the V1 test lead to positive conductor +1
- Connect the I1 current probe to conductor +1

Check that the current arrow on the sensor points towards the load. This ensures proper measurements for Power and other sign-sensitive quantities.

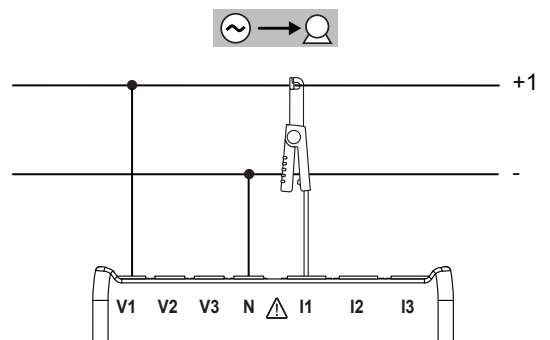

Figure 27

3.4.6.2. DC 3-Wire

For DC 3- Wire measurements:

- Connect the N test lead to the negative conductor
- Connect the V1 test lead to conductor +1
- Connect the V2 test lead to conductor +2
- Connect the I1 current probe to conductor +1
- Connect the I2 current probe to conductor +2

Check that the current arrows on the sensors point towards the load. This ensures proper measurements for Power and other sign-sensitive quantities.

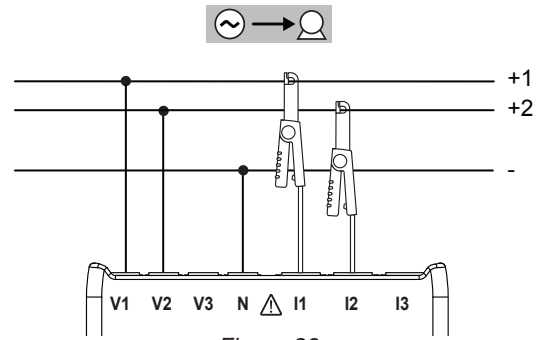

Figure 28

3.4.6.3. DC 4-Wire

For DC 4-Wire measurements and using three current sensors:

- Connect the N test lead to the negative conductor
- Connect the V1 test lead to conductor +1
- Connect the V2 test lead to conductor +2
- Connect the V3 test lead to conductor +3
- Connect the I1 current probe to conductor +1
- Connect the I2 current probe to conductor +2
- Connect the I3 current probe to conductor +3

Check that the current arrows on the sensors point towards the load. This ensures proper measurements for Power and other sign-sensitive quantities.

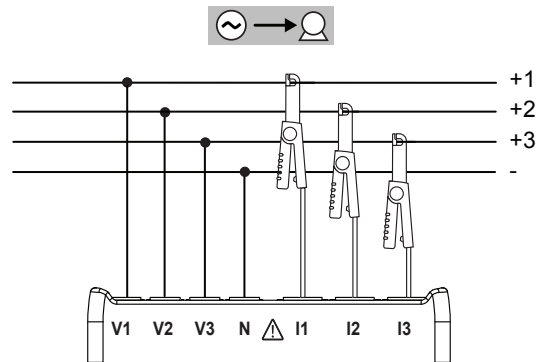





Figure 29



3.5. DISPLAY MODES (PEL 103)



This section provides display screen examples for each display mode. With the PEL, the user can scan through various measurement values and set-up parameters.



The **Navigation**  and **Enter**  buttons are used to scroll through the Display Modes and move between them.



The six display modes are:



- Real time measured values: V, A, Power, Frequency , Power Factor, tan Φ - 



press 
- Energy Values: kWh, Vah, Varh - 

press 
- Harmonics (for Current and Voltage) - 

press 
- Aggregated Max values for current, voltage and power - 

press 
- Information on hook-up selection, PT and CT ratios, IP Address, Software Version and Serial No. - 

press 
- Configuring the instrument - 

press  to go to 

For detailed instructions on configuring, recording, and downloading measurements, refer to § 4.



3.5.1. MEASUREMENTS - VALUES DISPLAYED

The basic measurements, or instantaneous readings, are displayed sequentially in screens showing all phases. The display sequence varies according to the type of power network. Table 5 below shows the readings for each type of network.

- Each display is reached by pressing the down arrow ▼.
- To exit and move to a different display mode, press the ◀ or ▶ button.

Table 5 indicates the sequence of display unit screens (PEL103) for each type of hook-up. The example shows the display sequence for a 3-Phase 4-Wire network.

Step	1-Phase 2-Wire	1-Phase 3-Wire	3-Phase 3-Wire *	3-Phase 3-Wire balanced	3-Phase 4-Wire **	3-Phase 4-Wire ***	3-Phase 4-Wire balanced	DC 2-Wire	DC 3-Wire	DC 4-Wire
1	P I V F	I1 I2 I3 F	I1 I2 I3	I3 I3 I3	I1 I2 I3 "IN"	I1 I2 I3 "IN"	I1 I1 I1	P I V	I1 I2	I1 I2 I3
2	ϕ (I1, V1) "V-I ANGLE"	ϕ (I2, I1) "I ANGLE"	ϕ (I2, I1) ϕ (I3, I2) ϕ (I1, I3) "I ANGLE"		ϕ (I2, I1) ϕ (I3, I2) ϕ (I1, I3) "I ANGLE"	ϕ (I2, I1) ϕ (I3, I2) ϕ (I1, I3) "I ANGLE"				
3	P Q S "PF"	V1 V2 U12	U12 U23 U31 F	U12 U23 U31 F	V1 V2 V3	V1 - V3	V1 V1 V1		V1 V2	V1 V2 V3

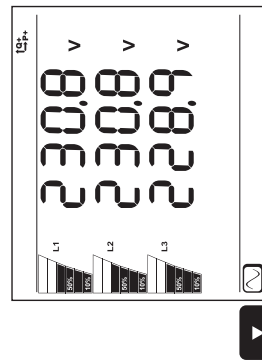
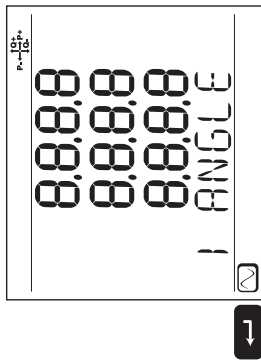
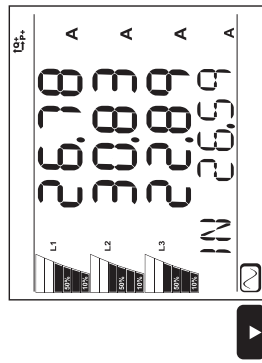

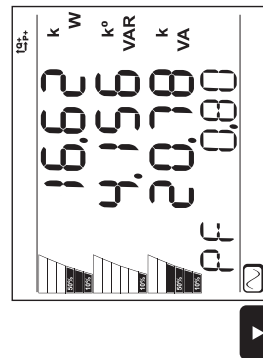
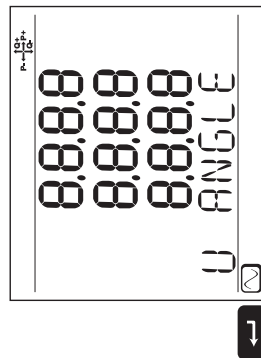
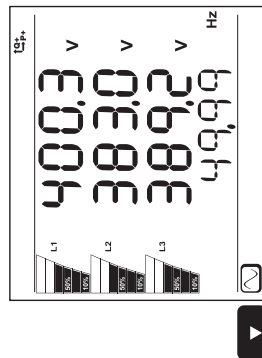
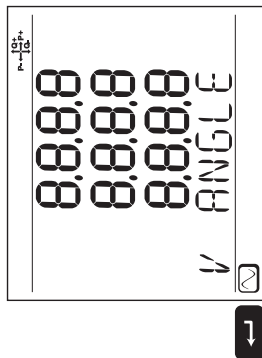

Step	1-Phase 2-Wire	1-Phase 3-Wire	3-Phase 3-Wire *	3-Phase 3-Wire balanced	3-Phase 4-Wire **	3-Phase 4-Wire ***	3-Phase 4-Wire balanced	DC 2-Wire	DC 3-Wire	DC 4-Wire
4		ϕ (V2, V1) "V ANGLE"	ϕ (U31, U23) ϕ (U12, U31) ϕ (U23, U12) "U ANGLE"		ϕ (V2, V1) ϕ (V3, V2) ϕ (V1, V3) "V ANGLE"					
5	P Q S "TAN"	P Q S "PF"	P Q S "PF"	P Q S "PF"	U12 U23 U31 F	U12 U23 U31 F	U12 U23 U31 F		P	P
6		ϕ (I1, V1) ϕ (I2, V2) "V-I ANGLE"	ϕ (I1, U12) ϕ (I2, U23) ϕ (I3, U31) "U-I ANGLE"	ϕ (I1, U12) "U-I ANGLE"	ϕ (U31, U23) ϕ (U12, U31) ϕ (U23, U12) "U ANGLE"					
7	P Q S "TAN"	P Q S "TAN"	P Q S "TAN"	P Q S "TAN"	P Q S "PF"	P Q S "PF"	P Q S "PF"			

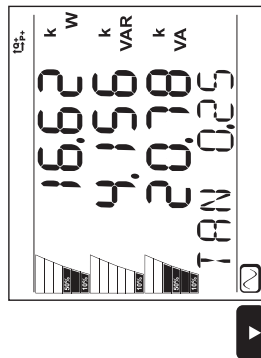
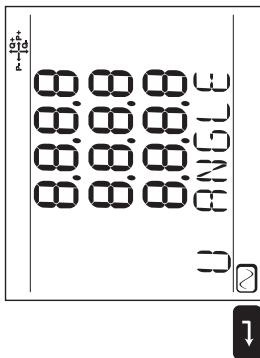

Figure 30

Step	1-Phase 2-Wire	1-Phase 3-Wire	3-Phase 3-Wire *	3-Phase 3-Wire balanced	3-Phase 4-Wire **	3-Phase 4-Wire ***	3-Phase 4-Wire balanced	DC 2-Wire	DC 3-Wire	DC 4-Wire
8					ϕ (I1, V1) ϕ (I2, V2) ϕ (I3, V3) "V-I ANGLE"	ϕ (I1, V1) ϕ (I3, V3) "V-I ANGLE"	ϕ (I1, V1) "V-I ANGLE"			
9					P Q S "TAN"	P Q S "TAN"	P Q S "TAN"			

Table 5

«---» = text displayed.

*: 3-Phase 3-Wire includes:

- 3-Phase 3-Wire Δ (with 2 current sensors)
- 3-Phase 3-Wire Δ (with 3 current sensors)
- 3-Phase 3-Wire Open Δ (with 2 current sensors)
- 3-Phase 3-Wire Open Δ (with 3 current sensors)
- 3-Phase 3-Wire Y (with 2 current sensors)
- 3-Phase 3-Wire Y (with 3 current sensors)

** : 3-Phase 4-Wire includes:

- 3-Phase 4-Wire Y (with 3 current sensors)
- 3-Phase 4-Wire Y 2½ Element

***: 3-Phase 4-Wire includes:

- 3-Phase 4-Wire Δ
- 3-Phase 4-Wire Open- Δ

3.5.2. ENERGY - VALUES DISPLAYED

The PEL measures the typical energy readings used. In addition, it can be used for advanced measurements by specialists or individuals doing in-depth analysis.

Individual power magnitudes for Power Flow Quadrants (per IEC 62053-23) are available by simply scrolling through each screen display. The values in specific quadrants are often used by engineers addressing power flow issues.

Definitions:

- **Ep+:** Total Active Energy Imported (used by load) in kWh
- **Ep-:** Total Active Energy Exported (to source) in kWh
- **Eq1:** Active Energy Imported (by load) in Inductive Quadrant (Quadrant 1) in kvarh.
- **Eq2:** Active Energy Exported (to source) in Capacitive Quadrant (Quadrant 2) in kvarh.
- **Eq3:** Active Energy Exported (to source) in Inductive Quadrant (Quadrant 3) in kvarh.
- **Eq4:** Active Energy Imported (by load) in Capacitive Quadrant (Quadrant 4) in kvarh.
- **Es+:** Total Apparent Energy Imported (by load) in kVAh
- **Es-:** Total Apparent Energy Exported (to source) in kVAh

Typically, industrial users will focus on the following values. The other values are used for load analysis and by utilities.

- **kWh:** Ep+ which is the Active Energy of the load
- **kvarh:** Eq1 which is the Reactive Energy of the load
- **kVAh:** Es+ which is the Apparent Energy of the load

The Energy measurements, which are time-dependent (typically 10- or 15- minute integration or aggregation periods), are displayed sequentially in screens showing all phases. Table 6 shows the readings for each type of network.

Use the down arrow ▼ to scroll down and the up arrow ▲ to scroll up through the displays.

The following examples show the display sequence for a 3-Phase 4-Wire network.

Each display is reached by pressing the down arrow ▼.

Energies are measured from the beginning of the recording session. Partial energies are the energies measured for a defined period (see § 4.3.5).

Partial Energy is reached by pressing the  button.

To return to the Energy settings, simply press the down arrow ▼.

Table 6 shows the display screen sequence (PEL103) for each type of hook-up.

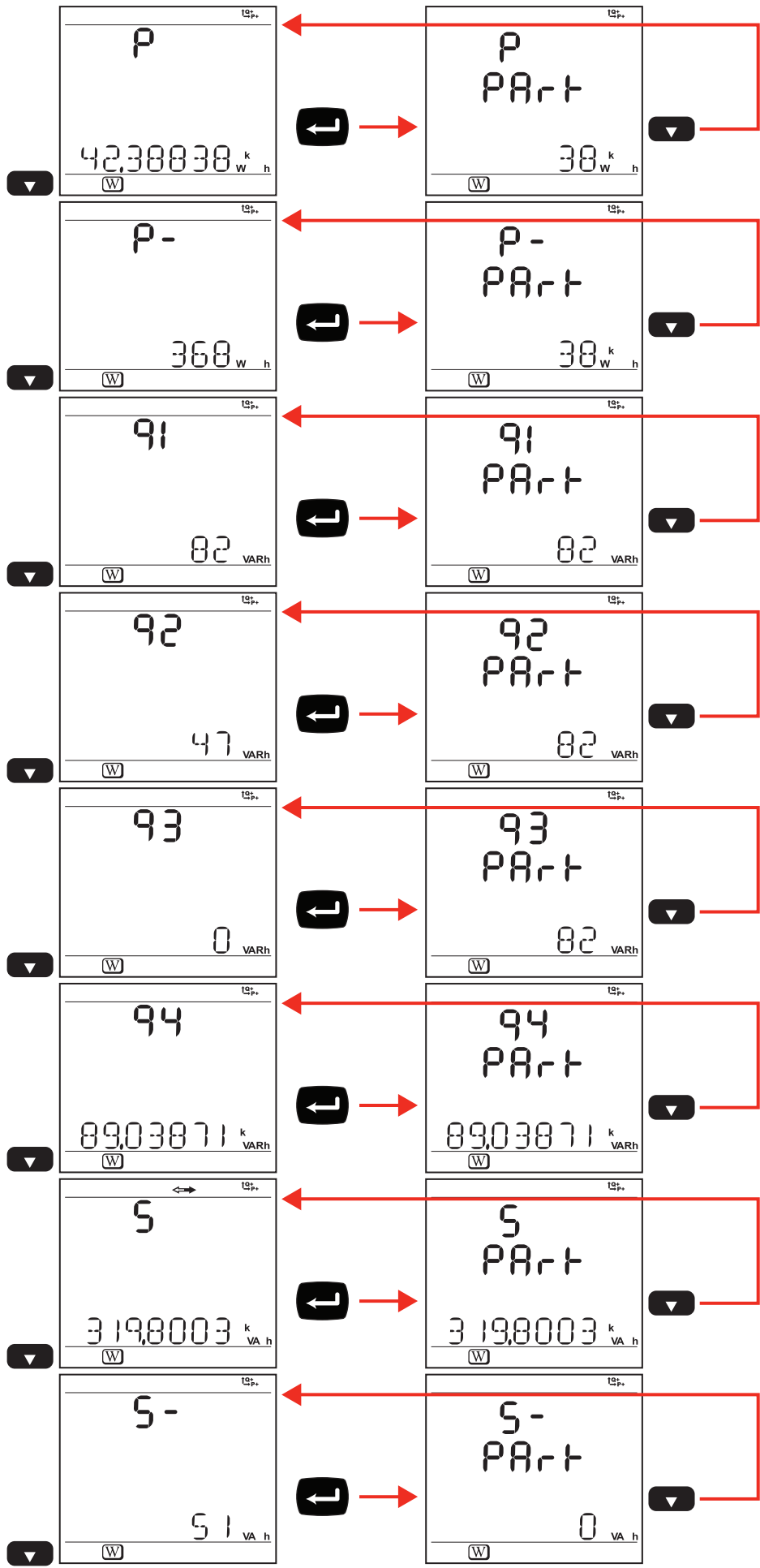

Figure 31

Table 6 indicates the sequence of display unit screens (PEL103) for each type of hook-up. The displays on the previous page show an example of the energy values for a 3-Phase 4-Wire network.

A press on **Enter** button displays the partial energies.

















Step	1-Phase 2-Wire 1-Phase 3-Wire 3-Phase 3-Wire * 3-Phase 4-Wire **	DC 2-Wire DC 3-Wire DC 4-Wire	Step	1-Phase 2-Wire 1-Phase 3-Wire 3-Phase 3-Wire * 3-Phase 4-Wire **	DC 2-Wire DC 3-Wire DC 4-Wire
1 	"p" Ep+	"p" Ep+	9 	"q3" Eq3	
2 	"p" PArT Ep+	"p" PArT Ep+	10 	"q3" PArT Eq3	
3 	"p" Ep-	"p" Ep-	11 	"q4" Eq4	
4 	"p" PArT Ep-	"p" PArT Ep-	12 	"q4" PArT Eq4	
5 	"q1" Eq1		13 	"S" Es+	
6 	"q1" PArT Eq1		14 	"S" PArT Es+	
7 	"q2" Eq2		15 	"S" Es-	
8 	"q2" PArT Eq2		16 	"S" PArT Es-	

Table 6

*: 3-Phase 3-Wire includes:

- 3-Phase 3-Wire Δ (with 2 current sensors)
- 3-Phase 3-Wire Δ (with 3 current sensors)
- 3-Phase 3-Wire Open Δ (with 2 current sensors)
- 3-Phase 3-Wire Open Δ (with 3 current sensors)
- 3-Phase 3-Wire Y (with 2 current sensors)
- 3-Phase 3-Wire Y (with 3 current sensors)
- 3-Phase 3-Wire Δ Balanced (with 1 current sensor)

** : 3-Phase 4-Wire includes:

- 3-Phase 4-Wire Y (with 3 current sensors)
- 3-Phase 4-Wire Y Balanced
- 3-Phase 4-Wire Y 2½ Element
- 3-Phase 4-Wire Δ
- 3-Phase 4-Wire Open-Δ

3.5.3. HARMONICS DISPLAY

Table 7 indicates the sequence of display unit screens (PEL103) for each type of connection. The displays show an example of the harmonic values for a 3-Phase 4-Wire network.

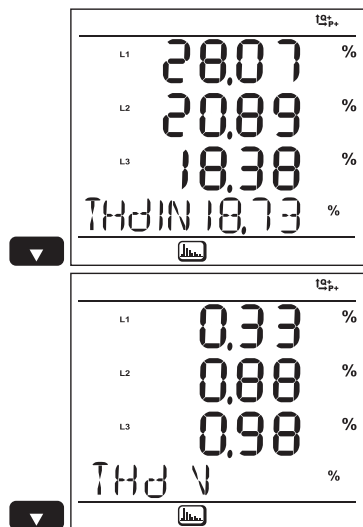

Figure 32

Step	1-Phase 2-Wire	1-Phase 3-Wire	3-Phase 3-Wire *	3-Phase 3-Wire balanced	3-Phase 4-Wire **	3-Phase 4-Wire balanced
1	THD_I THD_V	THD_I1 THD_I2	THD_I1 THD_I2 THD_I3 "THD I"	THD_I3 THD_I3 THD_I3 "THD I"	THD_I1 THD_I2 THD_I3 "THD IN"	THD_I1 THD_I1 THD_I1 "THD I"
2		THD_V1 THD_V2 THD_U12	THD_U12 THD_U23 THD_U31 "THD U"	THD_U12 THD_U12 THD_U12 "THD U"	THD_V1 THD_V2 THD_V3 "THD V"	THD_V1 THD_V1 THD_V1 "THD V"

Table 7

The harmonics function is disabled in DC

*: 3-Phase 3-Wire includes:

- 3-Phase 3-Wire Δ (with 2 current sensors)
- 3-Phase 3-Wire Δ (with 3 current sensors)
- 3-Phase 3-Wire Open Δ (with 2 current sensors)
- 3-Phase 3-Wire Open Δ (with 3 current sensors)
- 3-Phase 3-Wire Y (with 2 current sensors)
- 3-Phase 3-Wire Y (with 3 current sensors)

** : 3-Phase 4-Wire includes:

- 3-Phase 4-Wire Y (with 3 current sensors)
- 3-Phase 4-Wire Y $2\frac{1}{2}$ Element
- 3-Phase 4-Wire Δ
- 3-Phase 4-Wire Open- Δ

3.5.4. MAX DISPLAY

Table 8 indicates the sequence of display unit screens (PEL103) for each type of hook-up. The displays show an example of the aggregated Max values for a 3-Phase 4-Wire network.

According to the selected option in the PEL Transfer, it can be the maximum aggregated values for the recording in progress or the last recording, or the maximum aggregated values since the last reset.

Max is not available for DC distribution systems. In DC, LCD displays “No Max in DC Mode”.

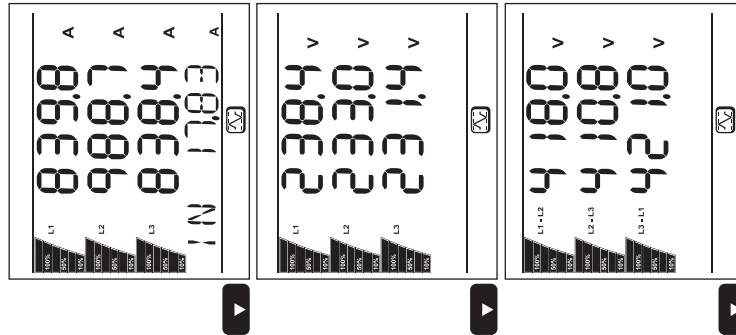

Step	1-Phase 2-Wire	1-Phase 3-Wire	3-Phase 3-Wire *	3-Phase 3-Wire balanced	3-Phase 4-Wire **	3-Phase 4-Wire balanced	DC 2-Wire	DC 3-Wire	DC 4-Wire
1	I V	I1 I2	I1 I2 I3	I1 I2 I3	I1 I2 I3 "IN"	I1 I2 I3			
2	P Q S "LOAD"	V1 V2 U12	U12 U23 U31	U12 U23 U31	V1 V2 V3	V1 V2 V3			
3	P Q S "SOURCE"	P Q S "LOAD"	P Q S "LOAD"	P Q S "LOAD"	U12 U23 U31	U12 U23 U31			

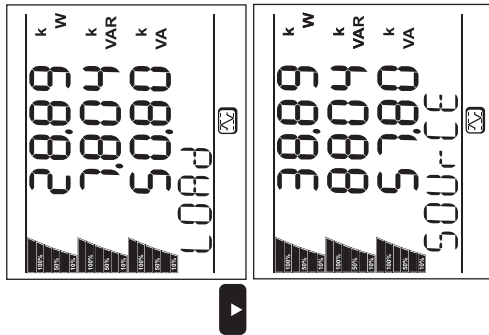

Figure 33

Step	1-Phase 2-Wire	1-Phase 3-Wire	3-Phase 3-Wire *	3-Phase 3-Wire balanced	3-Phase 4-Wire **	3-Phase 4-Wire balanced	DC 2-Wire	DC 3-Wire	DC 4-Wire
4		P Q S "SOURCE"	P Q S "SOURCE"	P Q S "SOURCE"	P Q S "LOAD"	P Q S "LOAD"			
5					P Q S "SOURCE"	P Q S "SOURCE"			

Table 8

*: 3-Phase 3-Wire includes:

- 3-Phase 3-Wire Δ (with 2 current sensors)
- 3-Phase 3-Wire Δ (with 3 current sensors)
- 3-Phase 3-Wire Open Δ (with 2 current sensors)
- 3-Phase 3-Wire Open Δ (with 3 current sensors)
- 3-Phase 3-Wire Y (with 2 current sensors)
- 3-Phase 3-Wire Y (with 3 current sensors)

**: 3-Phase 4-Wire includes:

- 3-Phase 4-Wire Y (with 3 current sensors)
- 3-Phase 4-Wire Y 2½ Element
- 3-Phase 4-Wire Δ
- 3-Phase 4-Wire Open- Δ

3.5.5. INFORMATION DISPLAY

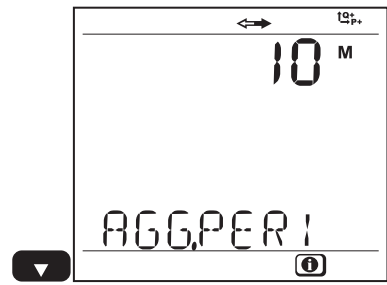
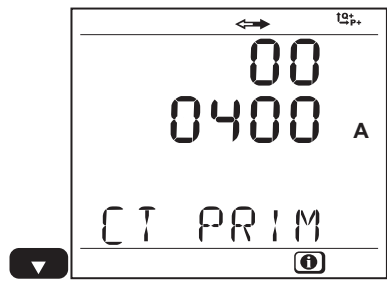
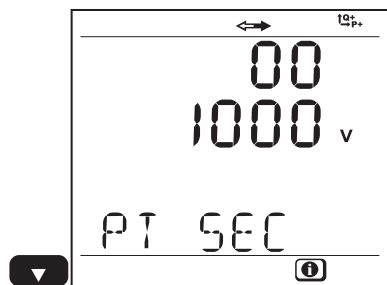
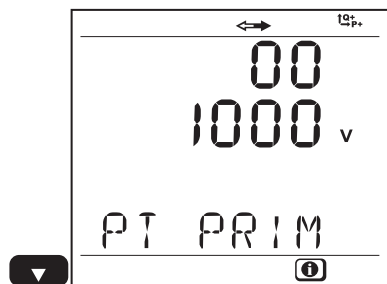
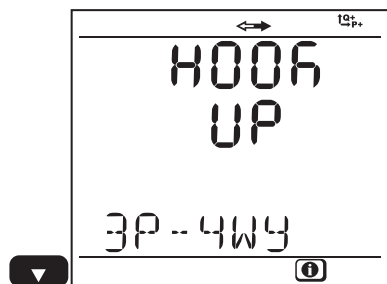

Step	Value	Units
1	Network Type	1P-2W = 1-phase 2-wire 1P-3W = 1-phase 3-wire 3P-3WΔ3 = 3-phase 3-wire Δ (3 current sensors) 3P-3WΔ2 = 3-phase 3-wire Δ (2 current sensors) 3P-3W02 = 3-phase 3-wire Open Δ (2 current sensors) 3P-3W03 = 3-phase 3-wire Open Δ (3 current sensors) 3P-3WΔB = 3-phase 3-wire Δ balanced 3P-3WY = 3-phase 3-wire Y (3 current sensors) 3P-3WY2 = 3-phase 3-wire Y (2 current sensors) 3P-4WY = 3-phase 4-wire Y 3P-4WYB = 3-phase 4-wire Y balanced (fixed, voltage measurement) 3P-4WY2 = 3-phase 4-wire Y 2½ 3P-4WΔ = 3-phase 4-wire Δ 3P-4W0Δ = 3-phase 4-wire Open Δ DC-2W = DC 2-wire DC-3W = DC 3-wire DC-4W = DC 4-wire
2	VT primary "PT PRIM"	V
3	VT secondary "PT SEC"	V
4	CT primary "CT PRIM"	A
5	Aggregation period "AGG.PERIOD"	min

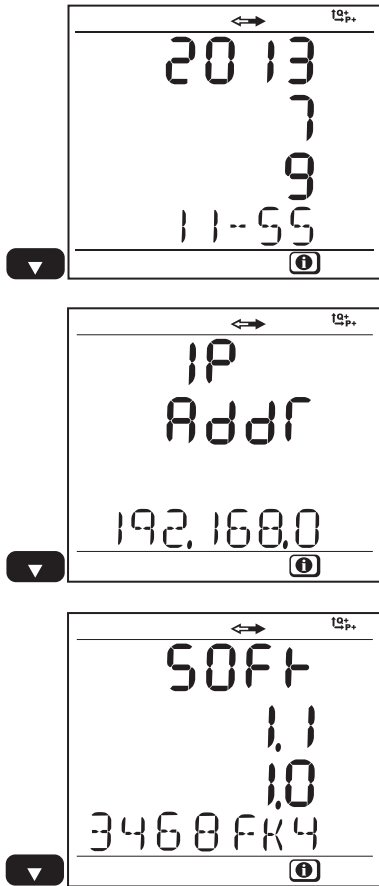



Figure 34

Step	Value	Units
6	Year Month Day Time	
7	IP address	Scrolling IP address
8	DSP version Soft version Serial number	DSP software version Microprocessor firmware version Scrolling serial number (a label is also pasted on the main board inside the PEL)

Table 9

The information screen is disabled (return to  measurement screen) 3 minutes after no action on **Enter** or **Navigation** buttons.





3.5.6. DISPLAY AND SETTINGS IN SET-UP FUNCTION

Set-up is not allowed when:

- PEL is recording (pending or in progress),
- Set-up is in progress with PEL Transfer or Android application,
- Set-up locked by user (**Control** button locked on front panel)

When Set-up screen is selected:

- configuration with PEL Transfer is not allowed
- starting a recording with **Control** button is not allowed.

Step	Value	Unit / Value	Comments
1 	Network Type	1P-2W 1P-3W 3P-3WΔ3 3P-3WΔ2 3P-3W02 3P-3W03 3P-3WΔB 3P-3WY 3P-3WY2 3P-4WY 3P-4WYB 3P-4WY2 3P-4WΔ 3P-4WOΔ DC-2W DC-3W DC-4W	1-phase 2-wire 1-phase 3-wire 3-phase 3-wire Δ (3 current sensors) 3-phase 3-wire Δ (2 current sensors) 3-phase 3-wire Open Δ (2 current sensors) 3-phase 3-wire Open Δ (3 current sensors) 3-phase 3-wire Δ balanced 3-phase 3-wire Y (3 current sensors) 3-phase 3-wire Y (2 current sensors) 3-phase 4-wire Y 3-phase 4-wire Y balanced (fixed, voltage measurement) 3-phase 4-wire Y 2½ 3-phase 4-wire Δ 3-phase 4-wire Open Δ DC 2-wire DC 3-wire DC 4-wire
2 	VT primary "PT PRIM"	V / kV	Primary nominal voltage: 50 V to 650 000 V
3 	VT secondary "PT SEC"	V	Secondary nominal voltage: 50 V to 1 000 V
4 	CT primary "CT PRIM"	A / kA	Primary nominal line current for the connected sensor <ul style="list-style-type: none"> ■ for AmpFLEX®: 100 A, 400 A, 2000 A, 10 000 A ■ for MN93A 5A range: 5 A to 25 000 A ■ for 5 A adapter box: 5 A to 25 000 A ■ for E3N clamp: 1 A to 25 000 A
5 	Aggregation period "AGG.PERIOD"	min	Configure the aggregation period in minutes: 1, 2, 3, 4, 5, 6, 10, 12, 15, 20, 30, 60

To modify the set-up:

- Press **Enter** button to enter modification mode.
- Press up or down arrow to select the new value.
- Press **Enter** button to exit modification mode.

The Set-up screen is disabled (return to  measurement screen) 3 minutes after no action on **Enter** or **Navigation** buttons.

4. PEL TRANSFER SOFTWARE



For contextual information on using PEL Transfer, refer to the Help Menu in the software.

4.1. INSTALLING PEL TRANSFER



Do not connect the instrument to the PC before installing the software and the drivers.

Minimum Computer Requirements:

- Windows XP / Windows Vista & Windows 7 (32/64 bit)
- 2 GB to 4 GB of RAM
- 10 GB of free hard disk space
- CD-ROM drive

Windows® is a registered trademark of Microsoft®.

1. Insert the CD (see #4 in Table 1) into your CD-ROM drive.
If auto-run is enabled, the program will start automatically.
If auto-run is disabled, select **Start.html** in **D:\SETUP** (if your CD-ROM drive is drive D. If this is not the case, substitute the appropriate drive letter).
If installing onto a Vista based computer the **User Account Control** dialog box will be displayed. Select the **Allow** option to proceed.

- Select your language and click on **START** in your browser. Authorize your browser to open the file.



Figure 35

- Select the Software column.



Figure 36

4. Select PEL Transfer.



Figure 37

5. Select **Read**.
6. Download the file, run it and follow the instructions.

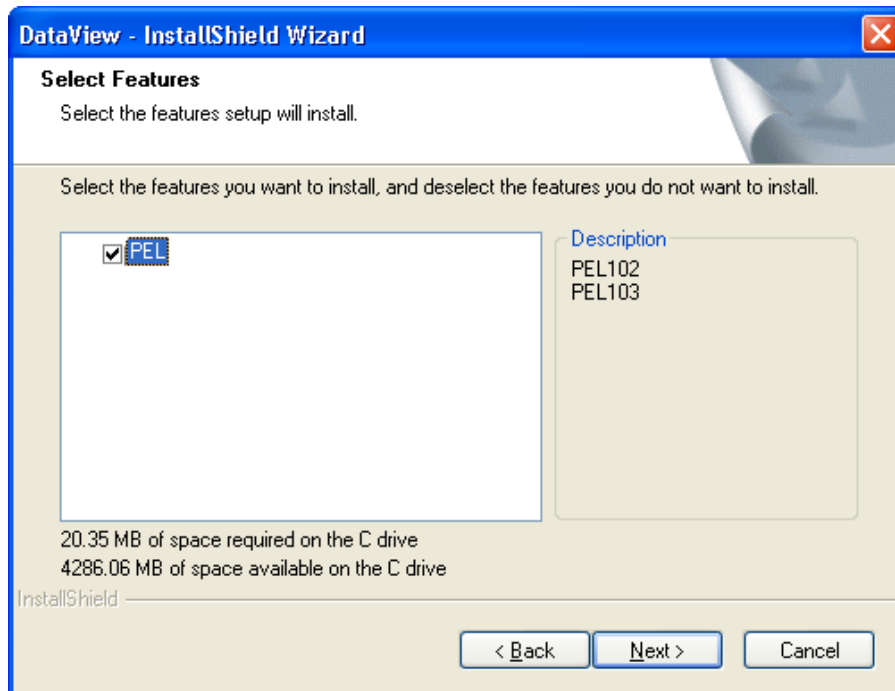

Figure 38

7. In the **Ready to Install the Program** window, click on **Install**.
8. If the instrument selected for installation requires the use of a USB port, a warning box, similar to below, will appear. Click on **OK**.

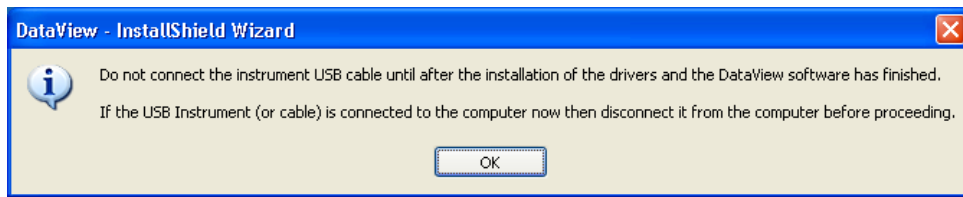

Figure 39



The installation of the drivers may take a few moments. Windows may even indicate that it is not responding, although it is running. Please wait for it to finish.

9. When the drivers are finished installing, the **Installation Successful** dialog box will appear. Click on **OK**.
 10. Next, the **Installation Wizard Complete** window will appear. Click on **Finish**.
 11. A **Question** dialog box appears next. Click on **Yes** to read the procedure for connecting the instrument to the USB port on the computer.
-



The Set-up window remains open. You may now select another option to download (e.g. Adobe® Reader), or close the window.

12. If necessary, reboot your computer.

Shortcut have been added to your desktop.

You can now open the PEL Transfer and connect your PEL to the computer.

4.2. CONNECTING TO A PEL

To connect to a PEL, perform the following steps:

1. Connect the power cord to an AC outlet. The instrument will power on.
2. Connect the supplied USB cable to the PEL and the PC.
3. Open the PEL Transfer by double-clicking on the **PEL icon**  that was created during installation, located on the desktop.

The Control Panel will be displayed:

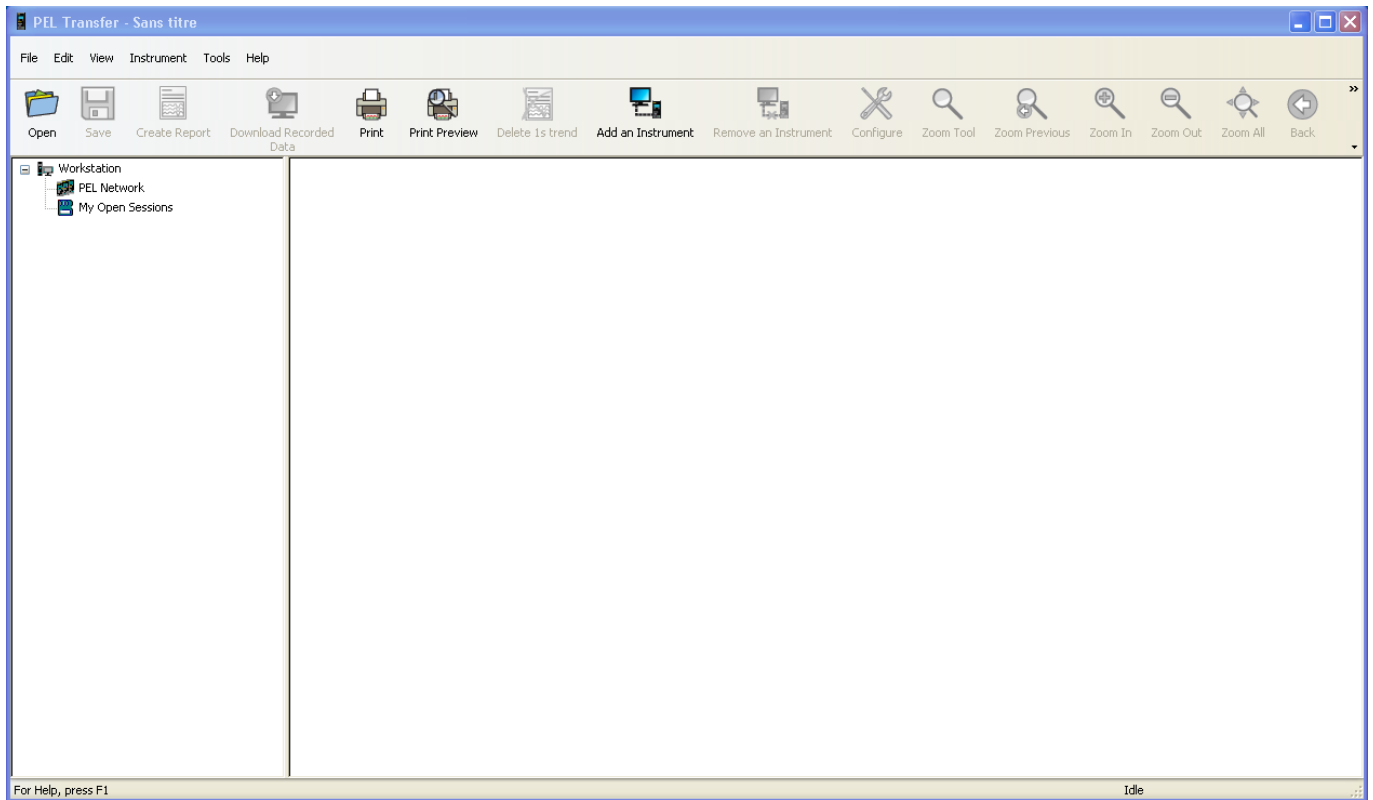

Figure 40

4. To connect to an instrument, do one of the following:

From the **Instrument** menu, select **Add an Instrument**.

or

From the **Toolbar**, click on the **Add an Instrument** icon.

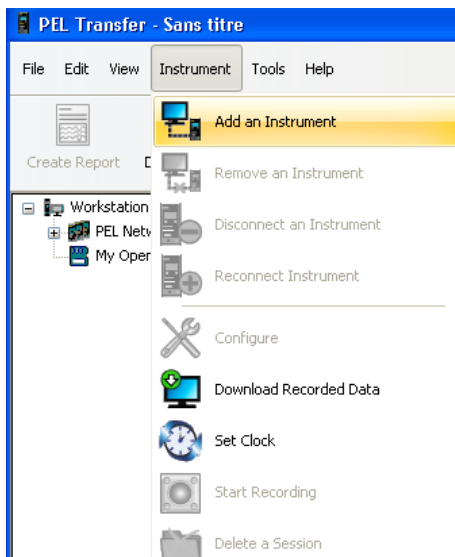

Figure 41



Figure 42

The first dialog box of the **Add an Instrument Wizard** will be displayed (illustrated below).

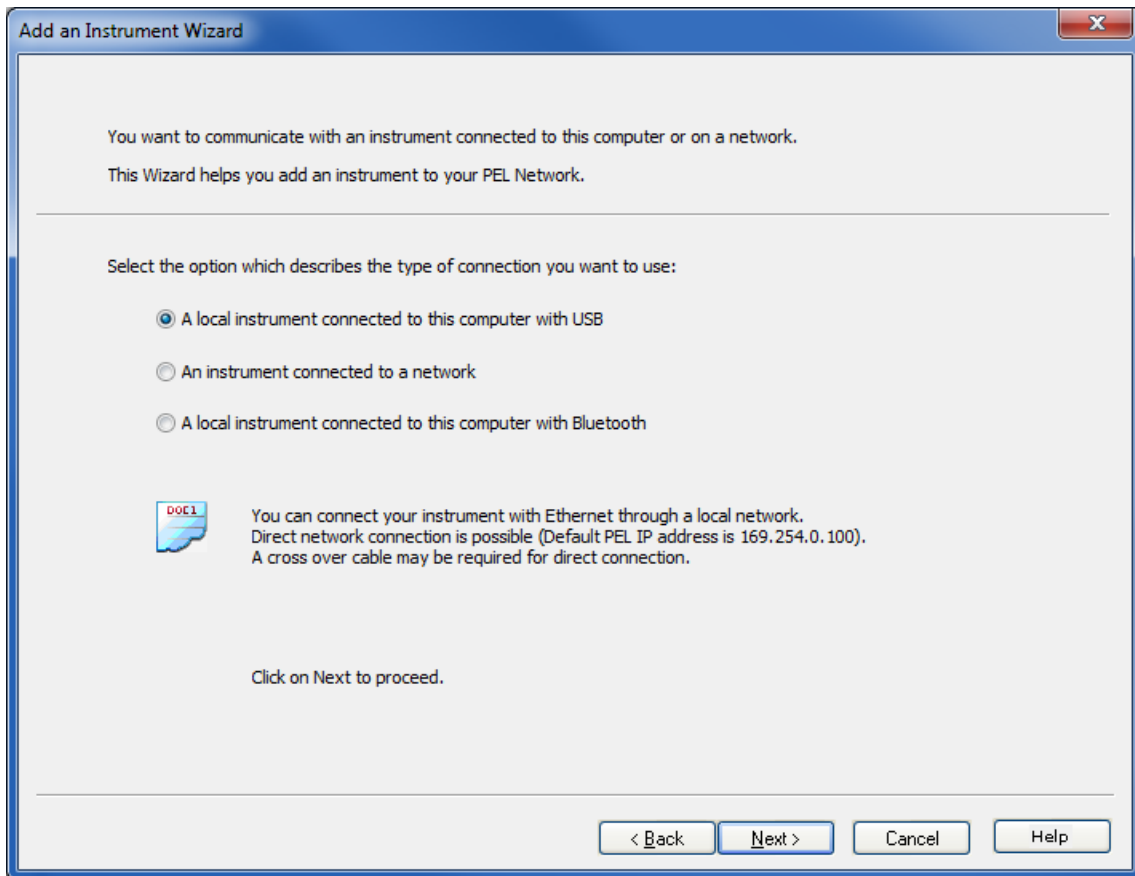

Figure 43

5. Select the desired connection type.



Note: The dialog boxes shown in this section correspond to the connection type chosen in Figure 43.

4.2.1. USB CONNECTION



A USB connection is the simplest and easiest connection to establish and is recommended when first learning how to use the PEL and PEL Transfer.

The USB connection dialog box lists all USB instruments currently connected to the computer.

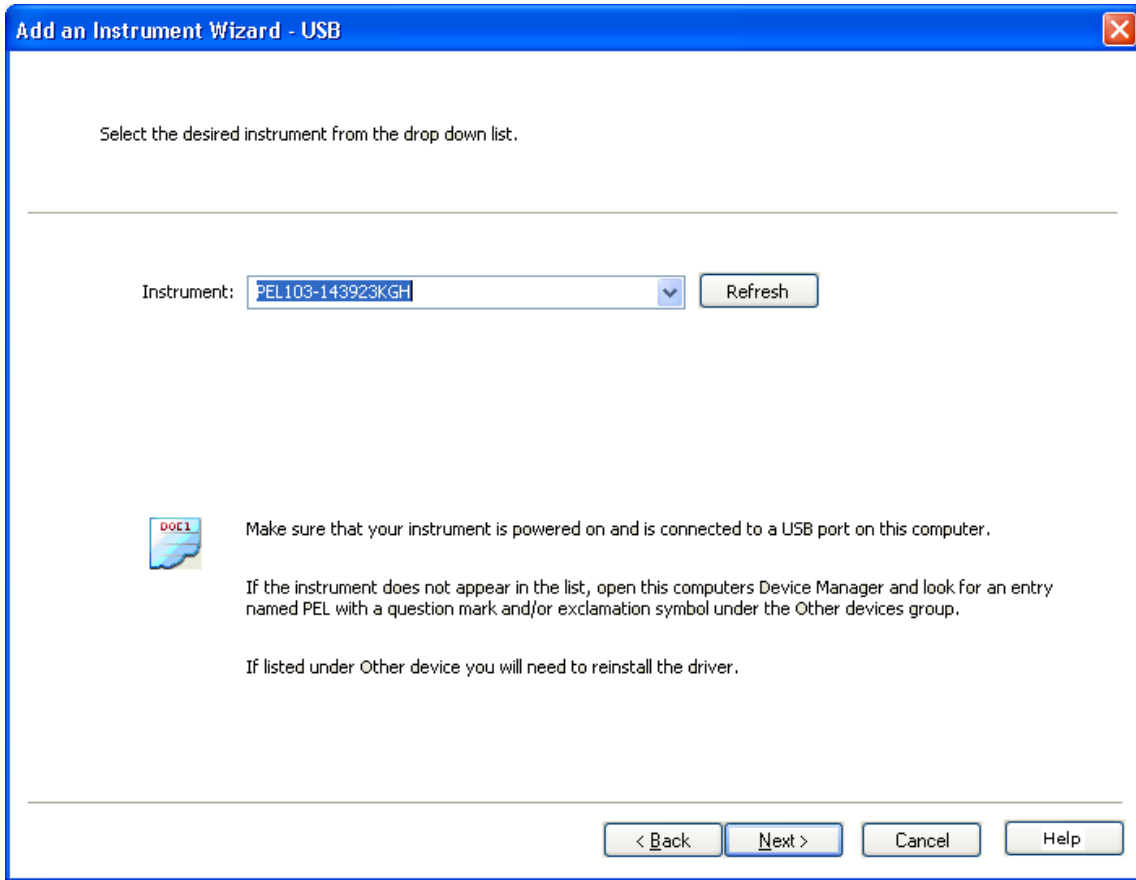

Figure 44

- From the **Instrument** drop-down list, select the desired instrument, then click on the **Next** button.
- If a successful connection is established, the **Finish** button is enabled. Click on **Finish** to exit the Wizard.

The instrument is then be added to the **PEL Network** list.

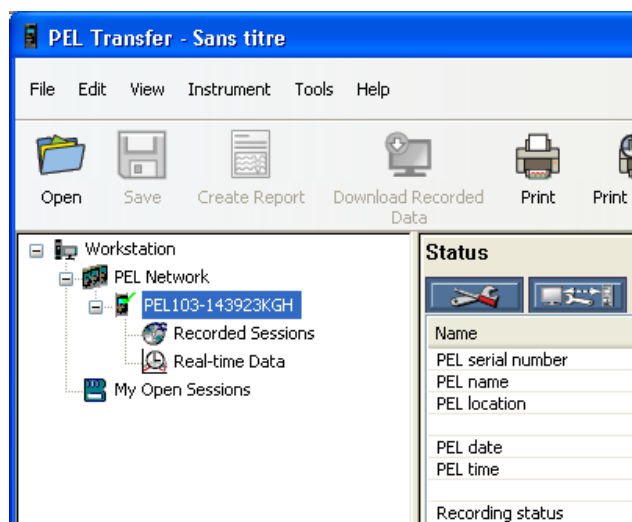

Figure 45

The instrument will remain in the PEL Network list until it is removed.

- To remove an instrument from the list, click on the **Remove an Instrument** icon in the Toolbar.

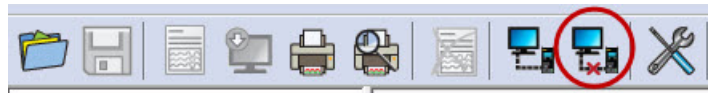

Figure 46

4.2.2. ETHERNET NETWORK CONNECTION

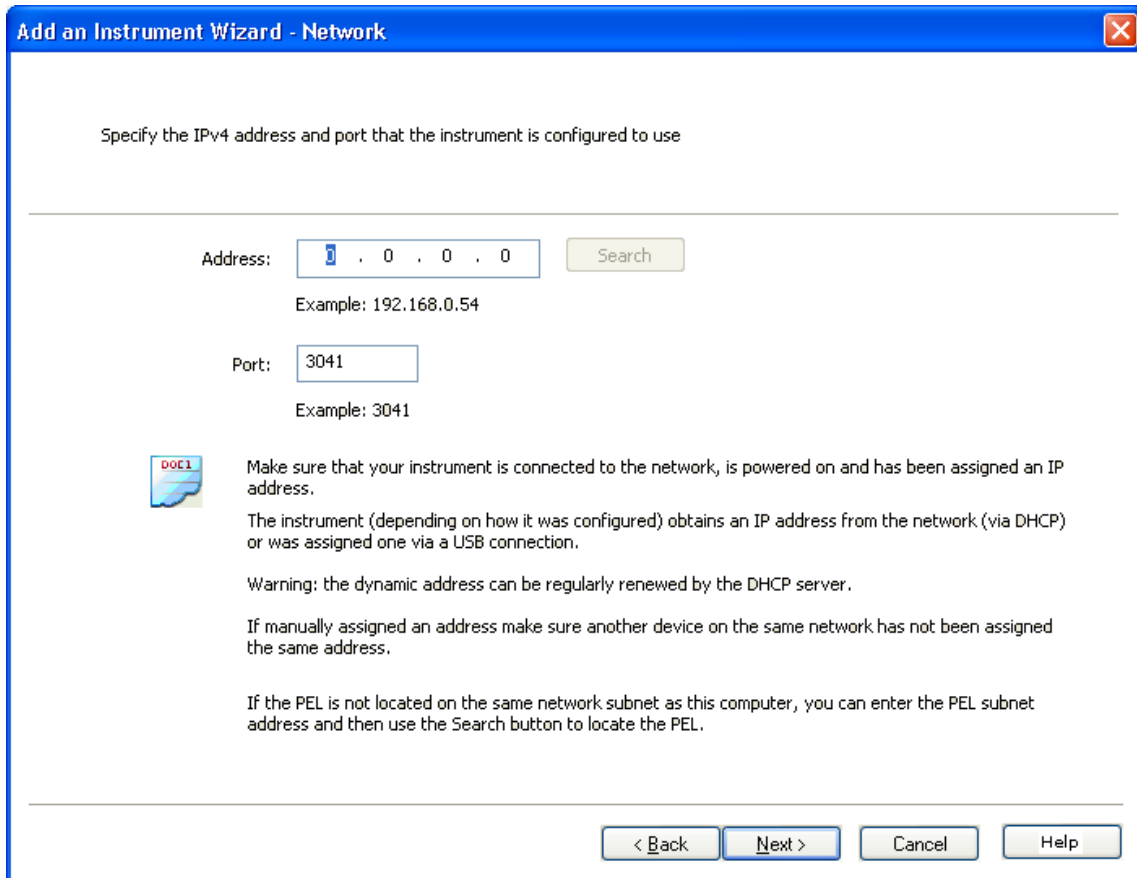

Figure 47

- In the **Address** field, enter the IP address assigned to the PEL.
 - For PEL103, select the information screen (on the instrument) and scroll down to the **IP Addr** display (see § 3.5.5).
 - For PEL102, a USB or Bluetooth connection should be used to determine the IP address assigned to the instrument (see § 4.3.2).
- By default the PEL uses port **3041 (UDP)**. However, the PEL can be configured to use a different port. The only way to identify the port the PEL is using is to first communicate with it. So, if the port has been changed from that of the default, use a USB or Bluetooth connection to identify the port used by the PEL (see § 4.3.2).

Note: If you do not know the IP address and the PEL is on the same sub-network as the computer, enter the IP address of the sub-network (for example 192.168.0.1) and use the **Search** button (located to the right of the Address field). The search operation, if successful, identifies the IP address for the port specified by each PEL connected to the sub-network.

- Once the IP address and port have been specified, click on the **Next** button.
- If a successful connection is established, the Finish button is enabled. Click on **Finish** to exit the Wizard.
- The instrument is then be added to the **PEL Network** list until it is removed (refer to § 4.2.1).

4.2.3. BLUETOOTH CONNECTION



Note: The Bluetooth radio devices of the PC and of the PEL must be enabled and turned on before a Bluetooth connection can be established.

In the Bluetooth connection dialog box, the PEL will be listed either by name or by communication port number. If the PEL Transfer can identify the PEL by name it will be listed in the drop-down list by name.

If not, you must select the communications port with which the PEL Bluetooth connection is associated. You can identify the associated communications port by opening the Bluetooth Devices dialog box, double clicking on the PEL entry (the PEL properties dialog box opens), then selecting the Services tab. The communications port number associated with the PEL Bluetooth connection will be listed here.

When using a Bluetooth connection, make sure the Bluetooth option button in the computer is activated and that the PEL has been paired with the computer. The PEL is paired to the computer using the **Add a device** option in the Bluetooth Devices dialog box. This dialog box can be displayed by double clicking on the Bluetooth icon next to the clock in the taskbar.

If the PEL is not listed in the Instrument drop-down list by name or by its associated communications port, make sure that the PEL is powered up, that the Bluetooth radio in the PEL is on, and that it is listed in the Bluetooth Devices dialog box. Also make sure that the Bluetooth has been activated in the PEL. The display and other Bluetooth options can be determined and set for the first time using a USB connection.

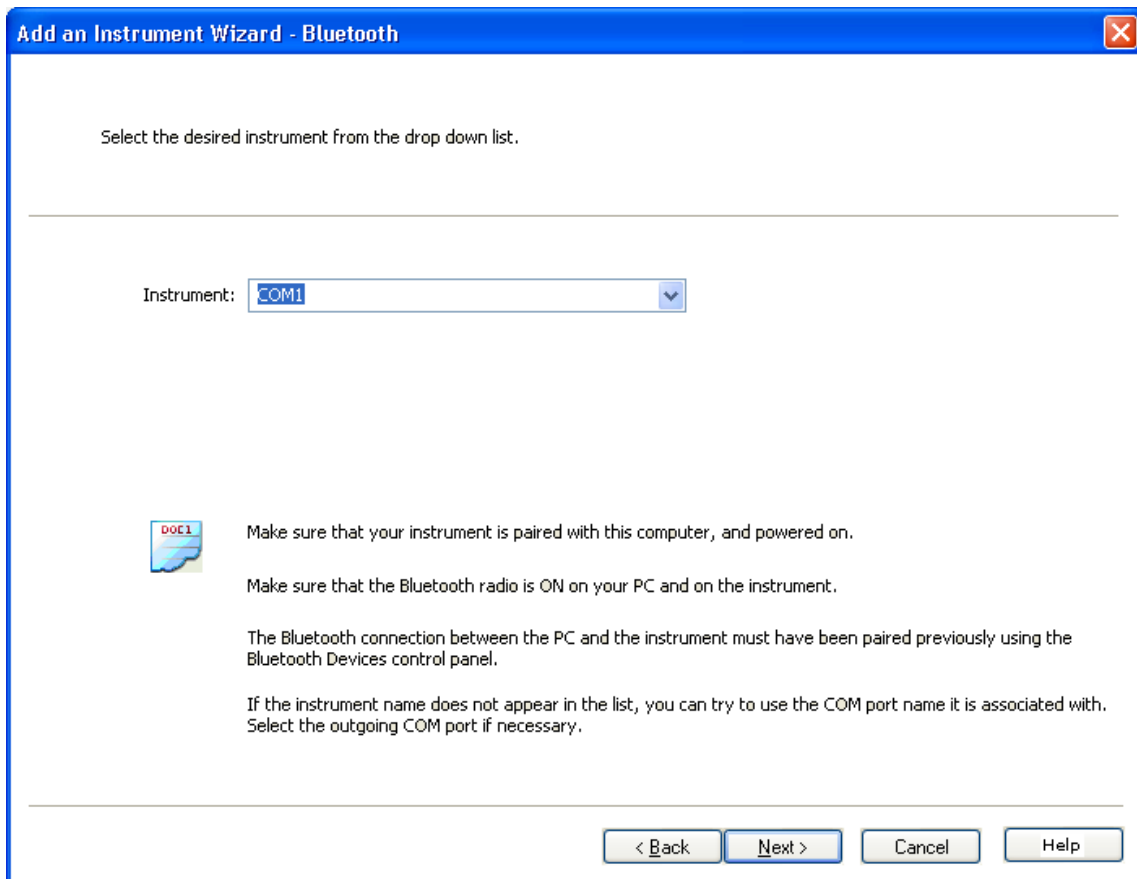

Figure 48

- From the **Instrument** drop-down list, select the desired PEL, then click on the **Next** button.
- If a successful connection is established, the Finish button is enabled. Click on **Finish** to exit the Wizard.
- The instrument is then be added to the **PEL Network** list until it is removed (refer to § 4.2.1).

4.3. CONFIGURING THE PEL

To Configure the PEL, perform the following steps:

1. Open the **PEL Transfer** and connect an instrument (refer to § 4.4 and 4.2).
2. Next, select **Configure** from the **Instrument** menu (refer to § 4.3).

The **Configure Instrument** dialog box consists of five tabs. Each tab contains a specific set of options associated with the instrument to be configured.



The configuration of an instrument cannot be changed while a recording is in progress. You must click on Stop Recording before proceeding.

4.3.1. GENERAL TAB OPTIONS

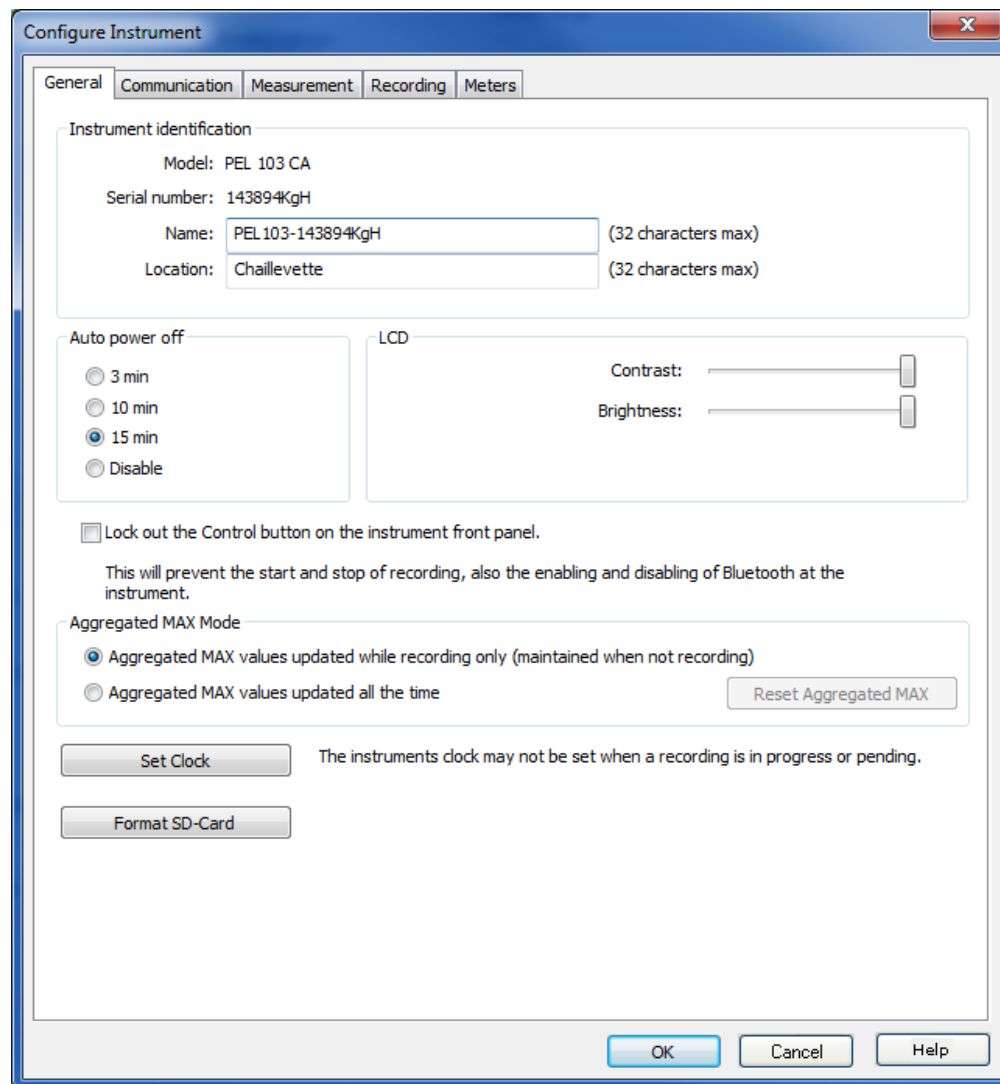

Figure 49

- **Name:** the name you want to give the PEL.
- **Location:** where the PEL is located.
- **Auto Power Off:** options to enable/disable the Auto Off function
- **LCD Contrast:** the contrast level of the instrument's LCD display.
- **LCD Normal mode brightness:** the brightness level after the **Enter** and **Navigation** buttons are pressed.
- **Lock out the Control button on the instrument front panel:** locks/unlocks the **Control** button. The **Enter** and **Navigation** buttons (PEL103) are not locked.

- The aggregated Max values are reset when the recording starts and are held when the recording ends.
- The aggregated Max values are always captured, even whether a recording is in progress or not. They are reset when the configuration measurement parameters changed or manually (unless recording is in progress).
- **Set Clock:** displays the Date/Time dialog box allowing you to set the date and time of the instrument.
- **Format SD-Card:** allows you to format the SD memory card currently installed in the instrument.

4.3.2. COMMUNICATION TAB OPTIONS

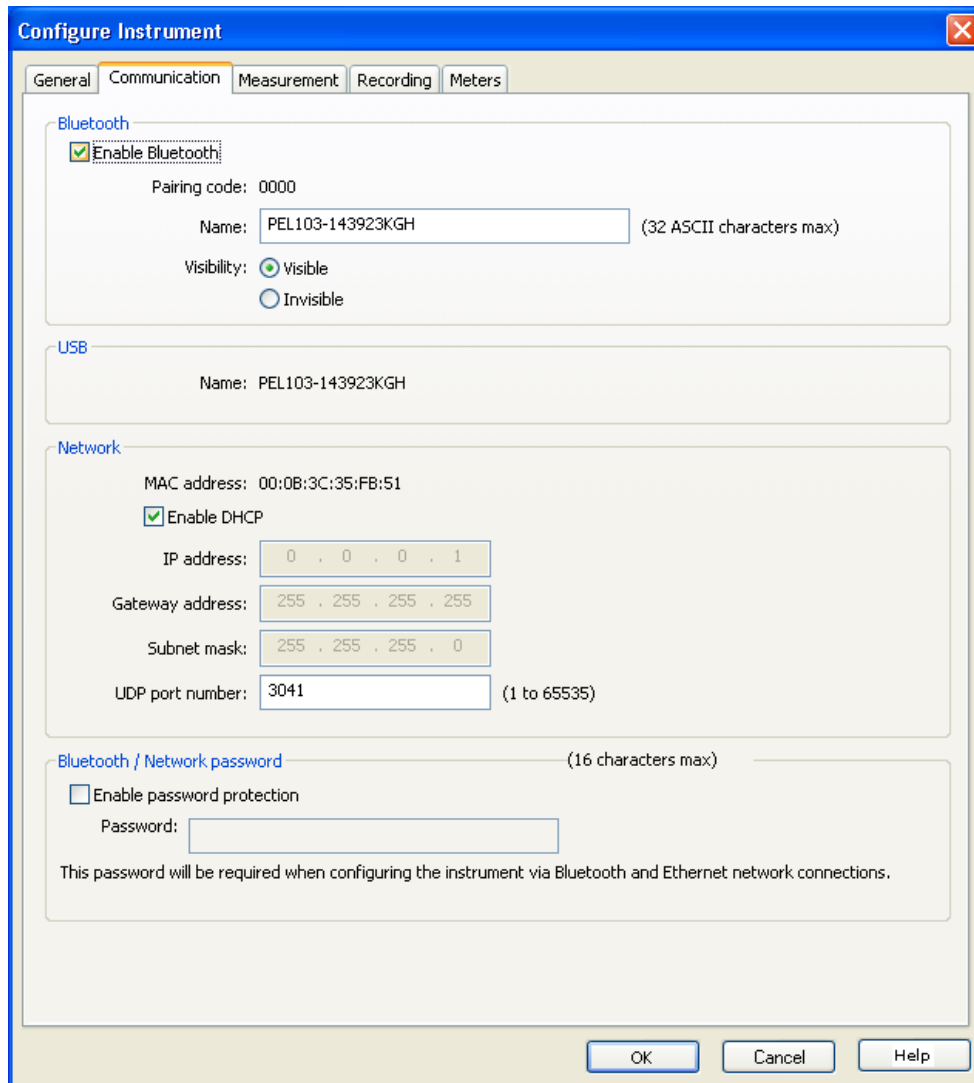

Figure 50

The **Communication** tab contains the following items:

- **Enable Bluetooth:** a check box that allows you to enable/disable the Bluetooth module in the instrument.
- **Pairing code:** displays the pairing code that must be used when pairing the instrument with a computer. The pairing code cannot be modified.
- **Name:** allows you to specify the name displayed when pairing with the instrument. Only ASCII characters must be used
- **Visibility:** allows you to hide the presence of the instrument from the search option of computers.
- **USB device name:** gives the name of the instrument as displayed in the instrument list (not modifiable).
- **MAC address:** gives the MAC address of the PEL.
- **Enable DHCP:** a check box that enables/disables the use of DHCP by the PEL.
- **IP address:** when DHCP is disabled, you can specify the IP address that the PEL is to use.
- **UDP port number:** allows you to specify the port number to be used by the instrument.
- **Enable password protection:** allows you to enable password verification when configuring the PEL.
- **Password:** when password protection is enabled you can specify the password to be used.

4.3.3. MEASUREMENT TAB OPTIONS

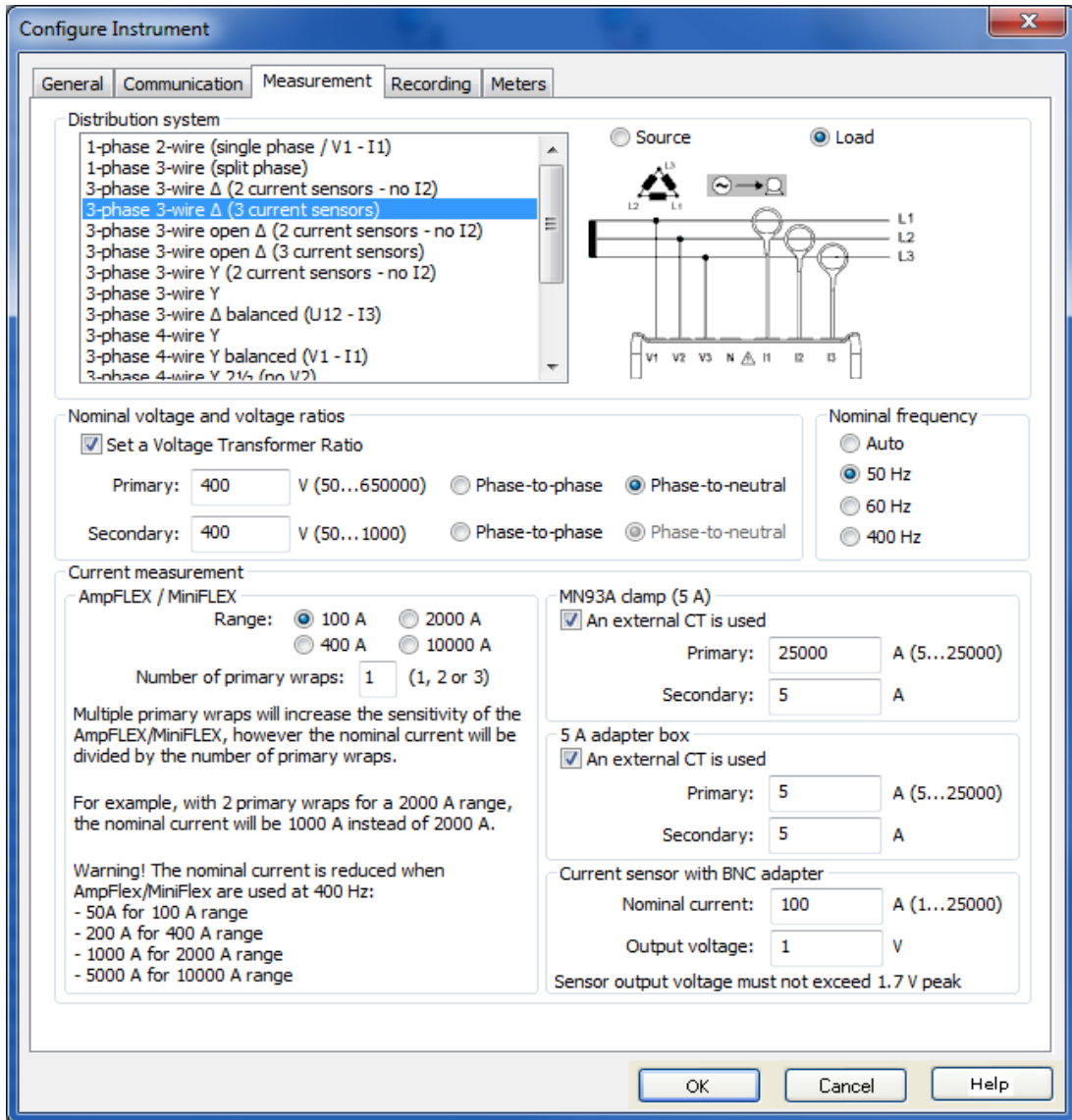

Figure 51

The **Measurement** tab contains the following items:

- **Distribution system:** allows you to specify the type of distribution network the PEL is measuring. See § 3.4 for the distribution systems available with the PEL.
Selection of DC 2-, 3- or 4-Wire implies DC measurements only. Selection of other distribution systems implies AC measurements only.
- **Load/Source:** used to check the hook up rotation phase. Select “Load” when energy is normally imported or “Source” when energy is normally exported.
- **Set a Voltage Transformer Ratio:** allows you to enable a voltage ratio for the PEL.
 - **Primary:** allows you to specify the primary voltage of the transformer ratio and whether it is phase-to-phase or phase-to-neutral.
 - **Secondary:** allows you to specify the secondary voltage of the transformer ratio and whether it is phase-to-phase or phase-to-neutral.

Note: The PEL 103 LCD will displays a phase-to-phase voltage as secondary voltage if the primary voltage is phase-to-phase and a phase-to-neutral voltage as secondary voltage if the primary voltage is phase-to-neutral.

Voltage Transformer Ratios

Parameter	Range	Increment
Primary Voltage	50 V to 650,000 V	1 V
Secondary Voltage	50 V to 1000 V	1 V

- **Nominal frequency:** allows you to specify the default frequency of the distribution network.
 - **Auto:** PEL detect the mains frequency of the distribution network.
 - **50 Hz, 60 Hz and 400 Hz:** PEL uses this frequency for measurements.

Note: Auto mode may lead to inconsistencies if the frequency varies in an unstable distribution system.

4.3.4. CURRENT SENSORS AND RATIOS

Current sensor ratios (and type) are automatically set with the identification of the current sensor detected on channel 1, or channel 2 if the current sensor on channel 1 is missing, or channel 3 if the current sensors on channel 1 and channel 2 are missing.

 **Note:** The current sensors must all be of the same type. Otherwise, the type of sensor connected on I1 is used for current sensor selection.

See § 5.2.4 for detailed specifications of the current sensors.

- **AmpFLEX/MiniFLEX Range:** allows you to select the current range for AmpFLEX®/MiniFLEX® probes.
 - **Number of turns:** allows you to specify the number of times the AmpFLEX®/MiniFLEX® is wrapped around the conductor.

Note: The maximum current of the selected AmpFLEX®/MiniFLEX® range is divided by the number of wraps.

- **MN 93A for 5A range:** allows you to specify the nominal primary current of an external transformer used with the MN93A clamp in the 5 A range.
- **5A adapter:** allows you to specify the nominal primary current of an external transformer used with the 5A adapter box.
- **BNC adapter:** allows you to specify the nominal primary current of a current probe used with the BNC adapter. The output of the current probe is a voltage of 1 V at the nominal primary current. The voltage output will not exceed 1.7 V_{peak}.

 **Warning:** The potential of the internal conductors of the BNC adapter and the connected current sensor is the potential of the neutral terminal of the PEL. If the neutral terminal is accidentally connected to a phase voltage, the current sensor connected to the PEL via the BNC adapter may be at the phase voltage. To prevent electric shocks or short-circuits hazards, always use current probes fully complying with IEC 61010-2-032.

 **Note:** When no ratio is entered, I nominal current is displayed on the PEL103 LCD (as primary current). No secondary current is displayed.

Current Transformer Ratios

Parameter	Range	Increment
Primary Current	5 A to 25000 A	1 A
Secondary Current	5 A	-

Table 10

 **Note:** The following conditions must be fulfilled or the configuration will be rejected by the PEL Transfer software:

- VT nominal primary voltage > VT nominal secondary voltage
- VT nominal primary voltage x CT nominal primary current < 650 MVA

4.3.5. RECORDING TAB OPTIONS

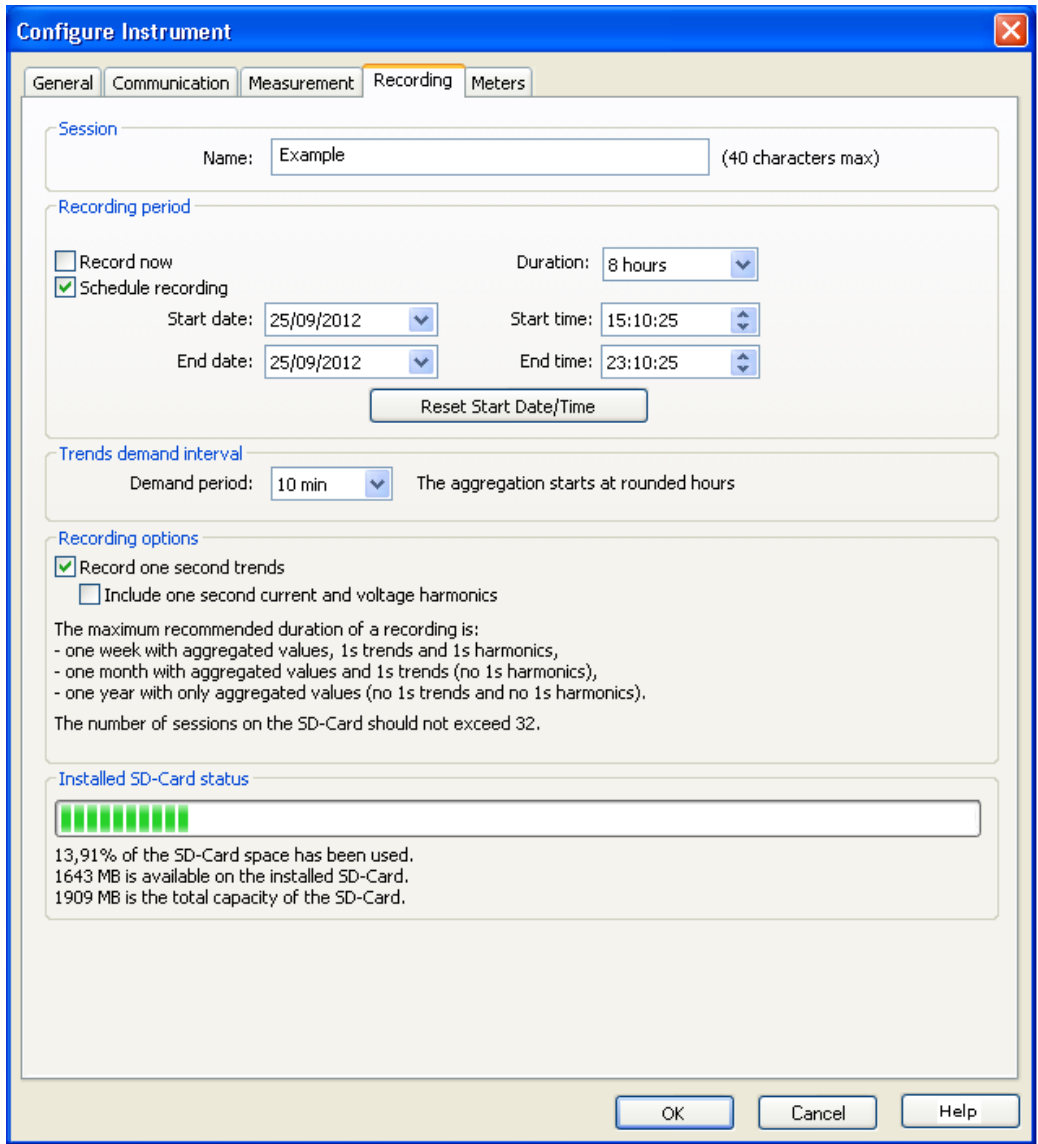

Figure 52

The **Recording** tab contains the following items:

- **Session Name:** allows you to assign a name to the recording session.



Note: If %d is added to the session name, it will be incremented automatically for each subsequent session.

- **Record Now:** check box that, when selected, will start recording when the configuration is written.
- **Schedule Recording:** check box that allows you to specify a date/time when recording will start.
- **Duration:** drop-down menu for predefined recording times.
- **Trend demand interval:** allows you to specify the aggregation period for smoothed measurements. Available periods = 1, 2, 3, 4, 5, 6, 10, 12, 15, 20, 30 and 60 min
- **Record one second trends:** used to indicate whether the “1s” data must be recorded.
- **Include one second current and voltage harmonics:** allows you to specify if harmonic data is to be recorded or not.

4.3.6. METERS TAB OPTIONS

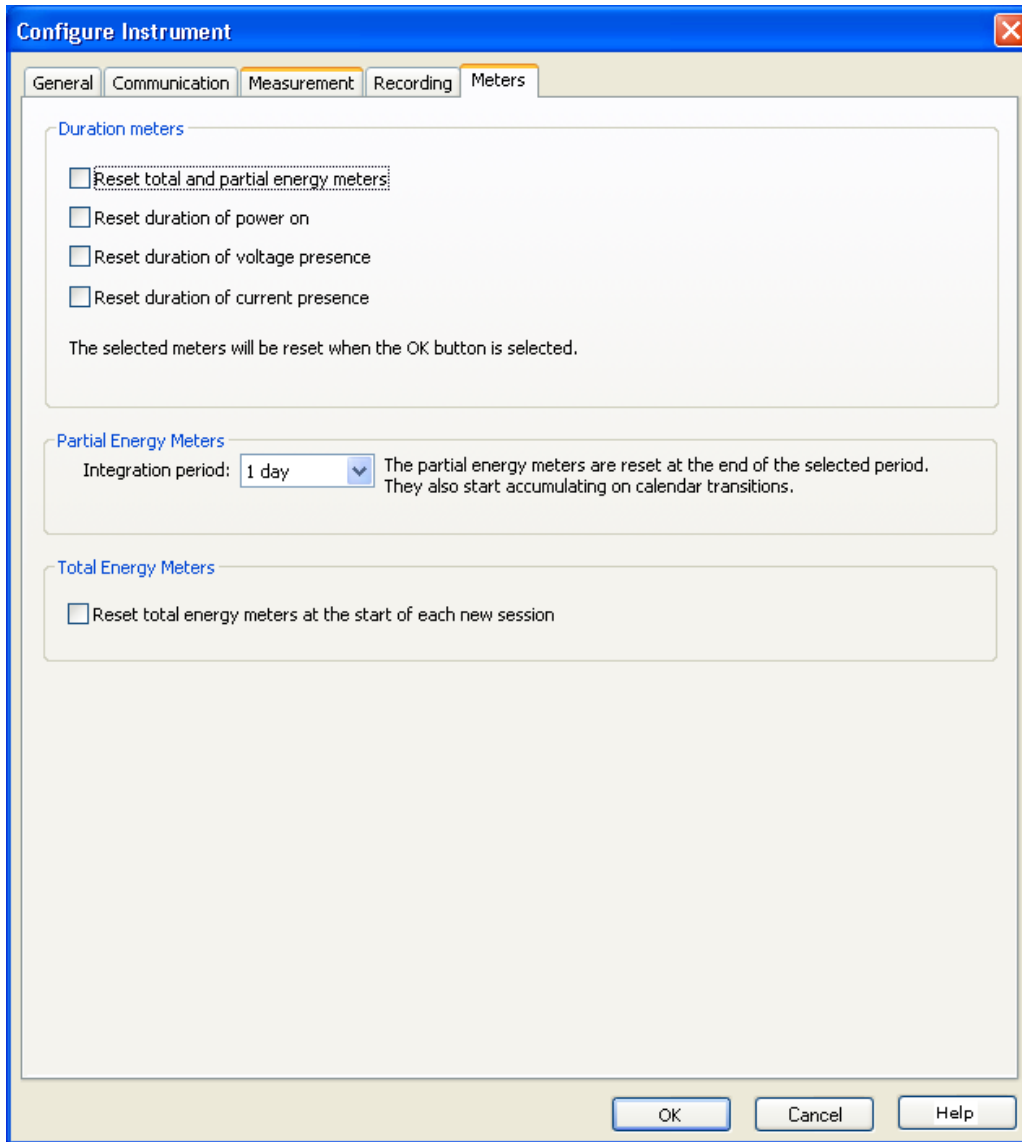

Figure 53

The **Meters** tab contains the following items:

- **Reset total and partial energy meters:** a check box used to reset the total meters in the instrument.



Note: Total and partial energy meters reset automatically each time a recording is started.

- **Reset duration of power on:** a check box that resets the Power On hour meter in the instrument.
- **Reset duration of voltage presence:** a check box that resets the voltage presence hour meter.
- **Reset duration of current presence:** a check box that resets the current presence hour meter.
- **Integration period:** used to assign a period to the partial energy meters of the device.
- **Reset total energy meters at the start of each new session.**

4.4. PEL TRANSFER

The main menu at the top of the screen lists the following commands:

File



Open: loads a previously saved recording session.



Close: closes the currently selected session.



Save: saves the currently selected session.



Save As: saves the currently selected session under a different name.



Create Report: generates a report from the currently selected session.



Export to Spreadsheet: saves measurements from the currently selected session to a spreadsheet file.



Print: prints the contents of the data frame.



Print Preview: displays the contents of the data frame as it would look if printed.



Print Setup: allows you to specify various printing options.

Exit: closes the control panel.

Edit



Edit Address book: allows you to specify address information about the selected session.



Edit Session Parameters: allows you to modify various parameters associated with the selected session.



Delete 1s trend: allows you to remove the 1 second measurements from the selected session.

View



Customize Toolbar: allows you to add and remove items from the toolbar.



Zoom Tool: changes the cursor to the Zoom tool for zooming in a graph.



Zoom Previous: restores the zoom level of a graph to its previous state.



Zoom In: increases the magnification of level of the displayed graph.



Zoom Out: decreases the magnification of level of the displayed graph.



Zoom All: adjusts the magnification of the displayed graph such that all samples are displayed.



Zoom To: allows you to specify a time period for the displayed graph.



Backwards: returns to the previous display.



Forwards: undoes a return to the previous display.

Instrument



Add an Instrument: add an instrument to the PEL Network list.



Remove an Instrument: removes the selected instrument from the PEL Network list.



Disconnect an Instrument: cuts off the connection with the selected instrument.



Reconnect Instruments: establishes a connection with the selected instrument.



Configure: opens the configuration dialog box for the selected instrument.



Download Recorded Data: downloads the selected session from the associated instrument.



Set Clocks for all instruments: opens the Date/Time dialog box to let you change the date of all connected instruments.



Start/Stop Recording: if the instrument is not recording, this menu option will read as Start Recording and when selected opens the Recording dialog box allowing you to start a recording. If the instrument is recording, this menu option will read as Stop Recording and will terminate the recording when selected.



Delete a Session: removes the selected session from the instrument.



Status: displays status information about the selected instrument in the data frame.

Tools



Colors: allows you to specify the default colors to be assigned to graph traces associated with specific measurements.



Cache: displays a dialog box allowing you to specify cache options for downloaded data.



Select Report: opens the Templates dialog box used to specify the default template to be used when creating a report.



Options: allows you to specify various program-related options.

Help



Help Topics: displays the PEL Transfer help table of contents.



PEL Manual: displays the user manual for the instrument.



Update: connects to the Chauvin Arnoux web site to determine the latest instrument software and firmware version.



About: displays the About dialog box.

4.5. DOWNLOADING RECORDED INSTRUMENT DATA

Recorded measurements stored in the instrument are transferred to a database on the PC using the **Download** command.

To Download a Recording:

1. Select a recorded session in the **Recorded session** branch of the PEL.
2. Select **Download Recorded Data** from the PEL **Instrument** menu or click on the **Download** button on the toolbar. This begins the transfer of recorded data to the computer.

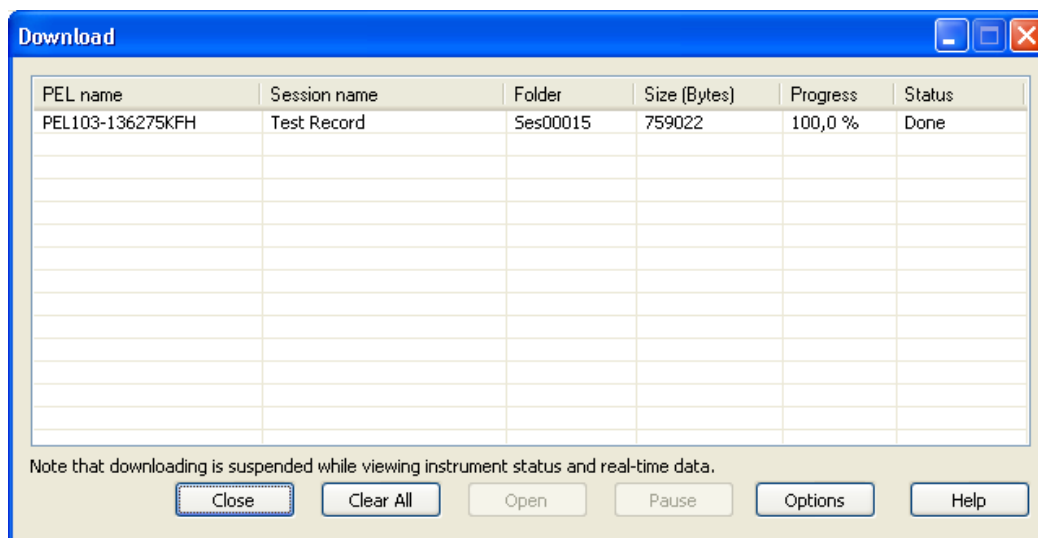

Figure 54

3. Once the transfer is complete, select the session and click on **Open**. The session will be added to the **My Open Sessions** navigation tree.
4. Selecting different items under the session name in **My Open Sessions** will display the associated data in the data frame.



1s harmonics and 1s trends cannot be downloaded from a recording in progress.

5. SPECIFICATIONS

5.1. REFERENCE CONDITIONS

Parameter	Reference Condition
Ambient temperature	23 ± 2 °C
Relative humidity	[45% RH; 75% RH]
Voltage	No DC component in AC, no AC component in DC (< 0.1 %)
Current	No DC component in AC, no AC component in DC (< 0.1 %)
Phase voltage	[100 V _{RMS} ; 1000 V _{RMS}] without DC (< 0.5%)
Input voltage of current inputs (except AmpFLEX® / MiniFLEX®)	[50 mV; 1.2 V] without DC (< 0.5%) for AC measurement, without AC (< 0.5%) for DC measurement
Supply system frequency	50 Hz ± 0.1 Hz and 60 Hz ± 0.1 Hz
Harmonics	< 0.1%
Voltage unbalance	0%
Preheating	Device powered for at least an hour
Common mode	Neutral input and enclosure are held at earth potential
	Instrument powered on battery, USB disconnected.
Magnetic field	0 A/m AC
Electric field	0 V/m AC

Table 11

5.2. ELECTRICAL SPECIFICATIONS

5.2.1. VOLTAGE INPUTS

Operating Range: up to 1 000 V_{RMS} for phase-to-neutral voltages
up to 1 700 V_{RMS} for phase-to-phase voltages



Note: Phase-to-neutral voltages lower than 2 V and phase-to-phase voltages lower than $2\sqrt{3}$ are zeroed.

Input Impedance: 1908 kΩ (phase-to-neutral)

Max Overload: 1100 V_{RMS} (phase-to-neutral)

5.2.2. CURRENT INPUTS



Note: Current sensor outputs are voltages.

Operating Range: 0.5 mV to 1.2 V (1 V = I_{nom}) with crest factor = $\sqrt{2}$

Input Impedance: 1 MΩ (except for AmpFLEX® / MiniFLEX® current sensors):
12.4 kΩ (AmpFLEX® / MiniFLEX® current sensors)

Max Overload: 1.7 V

5.2.3. INTRINSIC UNCERTAINTY (EXCLUDING CURRENT SENSORS)

5.2.3.1. Specifications at 50/60 Hz

Quantity	Measurement Range	Intrinsic uncertainty
Frequency (f)	[42.5 Hz ; 69 Hz]	± 0.1 Hz
Phase to neutral voltage (V)	[10 V ; 1000 V]	$\pm 0.2\% \pm 0.2$ V
Phase to phase voltage (U)	[17 V ; 1700 V]	$\pm 0.2\% \pm 0.4$ V
Current (I) without current sensor *	[0,2% Inom ; 120% Inom]	$\pm 0.2\% \pm 0.02\%$ Inom
Active power (P)	PF = 1 V = [100 V ; 1000 V] I = [5% Inom ; 120% Inom]	$\pm 0.5\% \pm 0.005\%$ Pnom
	PF = [0.5 inductive ; 0.8 capacitive] V = [100 V ; 1000 V] I = [5% Inom ; 120% Inom]	$\pm 0.7\% \pm 0.007\%$ Pnom
Reactive power (Q)	Sin φ = 1 V = [100 V ; 1000 V] I = [5% Inom ; 120% Inom]	$\pm 1\% \pm 0.01\%$ Qnom
	Sin φ = [0.5 inductive ; 0.5 capacitive] V = [100 V ; 1000 V] I = [5% Inom ; 120% Inom]	$\pm 1\% \pm 0.015\%$ Qnom
	Sin φ = [0.5 inductive ; 0.5 capacitive] V = [100 V ; 1000 V] I = [5% Inom ; 120% Inom]	$\pm 1.5\% \pm 0.015\%$ Qnom
	Sin φ = [0.25 inductive ; 0.25 capacitive] V = [100 V ; 1000 V] I = [5% Inom ; 120% Inom]	$\pm 3.5\% \pm 0.003\%$ Qnom
Apparent power (S)	V = [100 V ; 1000 V] I = [5% Inom ; 120% Inom]	$\pm 0.5\% \pm 0.005\%$ Snom
Power factor (PF)	PF = [0.5 inductive ; 0.5 capacitive] V = [100 V ; 1000 V] I = [5% Inom ; 120% Inom]	± 0.05
	PF = [0.2 inductive ; 0.2 capacitive] V = [100 V ; 1000 V] I = [5% Inom ; 120% Inom]	± 0.1
Tan Φ	Tan Φ = [$\sqrt{3}$ inductive ; $\sqrt{3}$ capacitive] V = [100 V ; 1000 V] I = [5% Inom ; 120% Inom]	± 0.02
	Tan Φ = [3.2 inductive ; 3.2 capacitive] V = [100 V ; 1000 V] I = [5% Inom ; 120% Inom]	± 0.05
Active energy (Ep)	PF = 1 V = [100 V ; 1000 V] I = [5% Inom ; 120% Inom]	$\pm 0.5\%$
	PF = [0.5 inductive ; 0.8 capacitive] V = [100 V ; 1000 V] I = [5% Inom ; 120% Inom]	$\pm 0.6\%$
Reactive energy (Eq)	Sin φ = 1 V = [100 V ; 1000 V] I = [5% Inom ; 120% Inom]	$\pm 2\%$
	Sin φ = [0.5 inductive ; 0.5 capacitive] V = [100 V ; 1000 V] I = [5% Inom ; 120% Inom]	$\pm 2\%$
	Sin φ = [0.5 inductive ; 0.5 capacitive] V = [100 V ; 1000 V] I = [5% Inom ; 120% Inom]	$\pm 2.5\%$
	Sin φ = [0.25 inductive ; 0.25 capacitive] V = [100 V ; 1000 V] I = [5% Inom ; 120% Inom]	$\pm 2.5\%$
Apparent energy (Es)	V = [100 V ; 1000 V] I = [5% Inom ; 120% Inom]	$\pm 0.5\%$

Quantity	Measurement Range	Intrinsic uncertainty
Harmonics number (1 to 25)	PF = 1 V = [100 V ; 1000 V] I = [5% Inom ; 120% Inom]	± 1%
THD	PF = 1 V = [100 V ; 1000 V] I = [5% Inom ; 120% Inom]	± 1%

Table 12

- *Inom* is the value of the measured current for a current sensor output of 1 V. See Table 27 and Table 28 for the nominal current values.
- *Pnom* and *Snom* are the active power and apparent power for $V = 1000\text{ V}$, $I = Inom$ and $PF = 1$.
- *Qnom* is the reactive power for $V = 1000\text{ V}$, $I = Inom$, and $\sin \varphi = 1$.
- *: The intrinsic uncertainty for input current (*I*) is specified for an isolated input voltage of $1\text{ V} = Inom$. The intrinsic uncertainty of the connected current sensor should be added to this intrinsic uncertainty to determine the total intrinsic uncertainty. In the case of using sensors AmpFLEX® and MiniFLEX®, intrinsic uncertainty is given in Table 28. The intrinsic uncertainty for neutral current is the maximum intrinsic uncertainty on I1, I2 and I3.

5.2.3.2. Specifications at 400 Hz

Quantity	Measurement Range	Intrinsic uncertainty
Frequency (f)	[340 Hz ; 460 Hz]	± 0.1 Hz
Phase to neutral voltage (V)	[10 V ; 600 V]	± 0.5% ± 0.5 V
Phase to phase voltage (U)	[17 V ; 1000 V]	± 0.5% ± 0.5 V
Current (I) without current sensor *	[0,2% Inom ; 120% Inom] ***	± 0.5% ± 0.05 % Inom
Active power (P)	PF = 1 V = [100 V ; 600 V] I = [5% Inom ; 120% Inom]	±2% ± 0.02% Pnom **
	PF = [0.5 inductive ; 0.8 capacitive] V = [100 V ; 600 V] I = [5% Inom ; 120% Inom]	±3% ± 0.03% Pnom **
Active energy (Ep)	PF = 1 V = [100 V ; 600 V] I = [5% Inom ; 120% Inom]	± 2% **

Table 13

- *Inom* is the value of the measured current for a current sensor output at 50/60 Hz. See Table 27 for the nominal current values.
- *Pnom* is the active power for $V = 600\text{ V}$, $I = Inom$ and $PF = 1$.
- *: The intrinsic uncertainty for input current (*I*) is specified for an isolated input voltage of $1\text{ V} = Inom$. The intrinsic uncertainty of the connected current sensor should be added to this intrinsic uncertainty to determine the total intrinsic uncertainty. In the case of using sensors AmpFLEX® and MiniFLEX®, intrinsic uncertainty is given in Table 28. The intrinsic uncertainty for neutral current is the maximum intrinsic uncertainty on I1, I2 and I3.
- **: Indicative maximum value of the intrinsic uncertainty. Higher uncertainties can be noted, in particular with EMI.
- ***: For AmpFLEX® and MiniFLEX®, the maximum current is limited to 60% *Inom* at 50/60 Hz, because of higher sensitivity.

5.2.3.3. Specifications in DC

Quantity	Measurement range	Typical intrinsic uncertainty **
Voltage (V)	V = [100 V ; 1000 V]	± 1% ± 3 V
Current (I) without current sensor *	I = [5% Inom ; 120% Inom]	± 1% ± 0.3% Inom
Power (P)	V = [100 V ; 1000 V] I = [5% Inom ; 120% Inom]	± 1% ± 0.3% Pnom
Energy (Ep)	V = [100 V ; 1000 V] I = [5% Inom ; 120% Inom]	± 1.5%

Table 14

- Inom is the value of the measured current for a current sensor output of 1 V. See Table 27 for the nominal current values.
- Pnom is the power for V = 1000 V and I = Inom.
- *: The intrinsic uncertainty for input current (I) is specified for an isolated input voltage of 1 V = Inom. The intrinsic uncertainty of the connected current sensor should be added to this intrinsic uncertainty to determine the total intrinsic uncertainty. In the case of using sensors AmpFLEX® and MiniFLEX®, intrinsic uncertainty is given in Table 28.
- The intrinsic uncertainty for neutral current is the maximum intrinsic uncertainty on I1, I2 and I3.
- **: Indicative maximum value of the intrinsic uncertainty. Higher uncertainties can be noted, in particular with EMI.

5.2.3.4. Phase order

Conditions for a correct phase order: current phase orders, voltage phase orders and current vs voltage phase order are correct.

Conditions of correct current phase order

Distribution system	Abbreviation	Voltage phase order	Comments
1-phase 2-wire	1P-2W	No	
1-phase 3-wire	1P-3W	Yes	$\varphi (I_2, I_1) = 180^\circ \pm 30^\circ$
3-phase 3-wire Δ (2 current sensors)	3P-3W Δ 2	Yes	$\varphi (I_1, I_3) = 120^\circ \pm 30^\circ$ No I2 current sensors
3-phase 3-wire Open Δ (2 current sensors)	3P-3W02		
3-phase 3-wire Y (2 current sensors)	3P-3WY2	Yes	$[\varphi (I_1, I_3), \varphi (I_3, I_2), \varphi (I_2, I_1)] = 120^\circ \pm 30^\circ$
3-phase 3-wire Δ (3 current sensors)	3P-3W Δ 3		
3-phase 3-wire Open Δ (3 current sensors)	3P-3W03		
3-phase 3-wire Y (3 current sensors)	3P-3WY3	No	
3-phase 3-wire Δ balanced	3P-3W Δ B		
3-phase 4-wire Y	3P-4WY	Yes	$[\varphi (I_1, I_3), \varphi (I_3, I_2), \varphi (I_2, I_1)] = 120^\circ \pm 30^\circ$
3-phase 4-wire Y balanced	3P-4WYB	No	
3-phase 4-wire Y 2½	3P-4WY2	Yes	$[\varphi (I_1, I_3), \varphi (I_3, I_2), \varphi (I_2, I_1)] = 120^\circ \pm 30^\circ$
3-phase 4-wire Δ	3P-4W Δ	Yes	$[\varphi (I_1, I_3), \varphi (I_3, I_2), \varphi (I_2, I_1)] = 120^\circ \pm 30^\circ$
3-phase 4-wire Open Δ	3P-4W0 Δ		
DC 2-wire	DC-2W	No	
DC 3-wire	DC-3W	No	
DC 4-wire	DC-4W	No	

Table 15

Conditions of correct voltage phase order

Distribution system	Abbreviation	Voltage phase order	Comments
1-phase 2-wire	1P-2W	No	
1-phase 3-wire	1P-3W	Yes	$\varphi (V2, V1) = 180^\circ \pm 10^\circ$
3-phase 3-wire Δ (2 current sensors)	3P-3W Δ 2	Yes (on U)	$[\varphi (U12, U31), \varphi (U31, U23), \varphi (U23, U12)] = 120^\circ \pm 10^\circ$
3-phase 3-wire Open Δ (2 current sensors)	3P-3W02		
3-phase 3-wire Y (2 current sensors)	3P-3WY2		
3-phase 3-wire Δ (3 current sensors)	3P-3W Δ 3	Yes (on U)	$[\varphi (U12, U31), \varphi (U31, U23), \varphi (U23, U12)] = 120^\circ \pm 10^\circ$
3-phase 3-wire Open Δ (3 current sensors)	3P-3W03		
3-phase 3-wire Y (3 current sensors)	3P-3WY3		
3-phase 3-wire Δ balanced	3P-3W Δ B	No	
3-phase 4-wire Y	3P-4WY	Yes (on V)	$[\varphi (V1, V3), \varphi (V3, V2), \varphi (V2, V1)] = 120^\circ \pm 10^\circ$
3-phase 4-wire Y balanced	3P-4WYB	No	
3-phase 4-wire Y 2½	3P-4WY2	Yes (on V)	$\varphi (V1, V3) = 120^\circ \pm 10^\circ$ No V2
3-phase 4-wire Δ	3P-4W Δ	Yes (on U)	$\varphi (V1, V3) = 180^\circ \pm 10^\circ$ $[\varphi (U12, U31), \varphi (U31, U23), \varphi (U23, U12)] = 120^\circ \pm 10^\circ$
3-phase 4-wire Open Δ	3P-4W0 Δ		
DC 2-wire	DC-2W	No	
DC 3-wire	DC-3W	No	
DC 4-wire	DC-4W	No	

Table 16

Conditions of correct current vs voltage phase order

Distribution system	Abbreviation	Voltage phase order	Comments
1-phase 2-wire	1P-2W	Yes	$\varphi (I1, V1) = 0^\circ \pm 60^\circ$ for load $\varphi (I1, V1) = 180^\circ \pm 60^\circ$ for source
1-phase 3-wire	1P-3W	Yes	$[\varphi (I1, V1), \varphi (I2, V2)] = 0^\circ \pm 60^\circ$ for load $[\varphi (I1, V1), \varphi (I2, V2)] = 180^\circ \pm 60^\circ$ for source
3-phase 3-wire Δ (2 current sensors)	3P-3W Δ 2	Yes	$[\varphi (I1, U12), \varphi (I3, U31)] = 30^\circ \pm 60^\circ$ for load $[\varphi (I1, U12), \varphi (I3, U31)] = 210^\circ \pm 60^\circ$ for source No I2 current sensor
3-phase 3-wire Open Δ (2 current sensors)	3P-3W02		
3-phase 3-wire Y (2 current sensors)	3P-3WY2		
3-phase 3-wire Δ (3 current sensors)	3P-3W Δ 3	Yes	$[\varphi (I1, U12), \varphi (I2, U23), \varphi (I3, U31)] = 30^\circ \pm 60^\circ$ for load $[\varphi (I1, U12), \varphi (I2, U23), \varphi (I3, U31)] = 210^\circ \pm 60^\circ$ for source
3-phase 3-wire Open Δ (3 current sensors)	3P-3W03		
3-phase 3-wire Y (3 current sensors)	3P-3WY3		
3-phase 3-wire Δ balanced	3P-3W Δ B	Yes	$\varphi (I3, U12) = 90^\circ \pm 60^\circ$ for load $\varphi (I3, U12) = 270^\circ \pm 60^\circ$ for source
3-phase 4-wire Y	3P-4WY	Yes	$[\varphi (I1, V1), \varphi (I2, V2), \varphi (I3, V3)] = 0^\circ \pm 60^\circ$ for load $[\varphi (I1, V1), \varphi (I2, V2), \varphi (I3, V3)] = 180^\circ \pm 60^\circ$ for source
3-phase 4-wire Y balanced	3P-4WYB	Yes	$\varphi (I1, V1) = 0^\circ \pm 60^\circ$ for load $\varphi (I1, V1) = 180^\circ \pm 60^\circ$ for source
3-phase 4-wire Y 2½	3P-4WY2	Yes	$[\varphi (I1, V1), \varphi (I3, V3)] = 0^\circ \pm 60^\circ$ for load $[\varphi (I1, V1), \varphi (I3, V3)] = 180^\circ \pm 60^\circ$ for source No V2
3-phase 4-wire Δ	3P-4W Δ	Yes	$[\varphi (I1, U12), \varphi (I2, U23), \varphi (I3, U31)] = 30^\circ \pm 60^\circ$ for load $[\varphi (I1, U12), \varphi (I2, U23), \varphi (I3, U31)] = 210^\circ \pm 60^\circ$ for source
3-phase 4-wire Open Δ	3P-4W0 Δ		
DC 2-wire	DC-2W	No	
DC 3-wire	DC-3W	No	
DC 4-wire	DC-4W	No	

Table 17

Load or source is set by configuration.

5.2.3.5. Temperature

For V, U, I, P, Q, S, PF, and E:

- 300 ppm/°C, with 5% < I < 120% and PF = 1
- 500 ppm/°C, with 10% < I < 120% and PF = 0.5 inductive
- DC offset V: 10 mv/°C typical
 I: 30 ppm Inom /°C typical

5.2.3.6. Common mode rejection

The common mode rejection ratio on neutral input is 140 dB typical.

For example, 110 V applied on the neutral input will add 11 µV on AmpFLEX®/MiniFLEX® values which is a 230 mA error at 60 Hz. 110 V applied on the neutral input will add 11 µV on other current sensors values which is a 0,01% Inom additional error.

5.2.3.7. Magnetic field influence

For current inputs to which MiniFLEX® or AmpFLEX® flexible current sensors are connected: 10 mA/A/m typically at 50/60 Hz.

5.2.4. CURRENT SENSORS

5.2.4.1. Precautions for use



Note: Refer to the safety sheet or user's manual that was supplied with your current sensors.

Current clamps and flexible current sensors are used to measure the current flowing in a cable without opening the circuit. They also insulate the user from dangerous voltages in the circuit.

The choice of current sensor to be used depends on the current to be measured and the diameter of the cables. When installing current sensors, have the arrow on the probe or sensor point towards the load.

5.2.4.2. Specifications

The measurement ranges are those of the sensors. In some cases, they may differ from the ranges that can be measured by the PEL. Refer to the users manual distributed with the current sensor.

a) MiniFLEX® MA193

The MiniFLEX® MA193 Flexible Current Sensor can be used to measure the current in a cable without opening the circuit. It also serves to isolate the user from hazardous voltages in the circuit. This sensor can only be used as an accessory of an instrument. If you have several sensors, you can mark each of them before connecting it using one of the color-coded rings supplied with the instrument to identify the phase. Then connect the sensor to the instrument.

- Press the yellow opening device to open the sensor. Then, place it around the conductor through which the current to be measured flows (only one conductor per sensor).

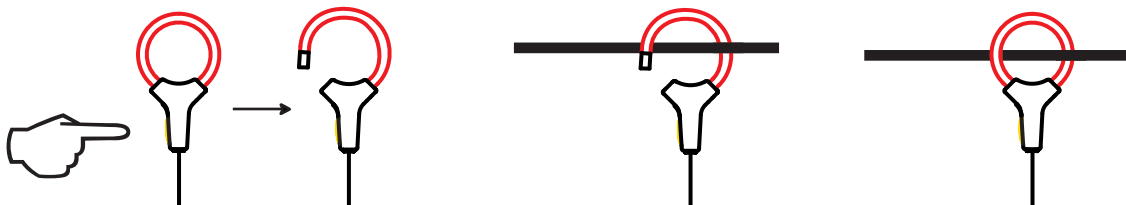

- Close the sensor. In order to optimize measurement quality, it is best to center the conductor in the sensor and make the shape of the sensor as circular as possible.
- To disconnect the sensor, open it and withdraw it from the conductor. Then disconnect the sensor from the instrument.

MiniFLEX® MA193	
Nominal Range	100/400/2000 A _{AC}
Measurement Range	50 mA to 2400 A _{AC}
Maximum Clamping Diameter	Length = 250 mm; Ø = 70 mm Length = 350 mm; Ø = 100 mm
Variation of the position of the conductor in the sensor	≤ 2,5%
Adjacent conductor carrying alternating current	≤ 1% for a conductor in contact with sensor and ≤ 2% near the snap device
Safety	IEC 61010-2-032, Pollution degree 2, 600 V CAT IV, 1000 V CAT III

Table 18

Note: Currents < 0.05% of the nominal range will be set to zero.
The nominal ranges are reduced to 50/200/1000 A_{AC} at 400 Hz.
The 10,000 A range only works if you can clamp the conductor in the MiniFlex® sensor.

b) PAC93 clamp

Note: Power calculations are zeroed when the current is zeroed.

PAC93 clamp	
Nominal Range	1000 A _{AC} , 1400 A _{DC} max
Measurement Range	1 to 1000 A _{AC} , 1 to 1300 A _{PEAK AC+DC}
Maximum Clamping Diameter	One 42 mm or two 25.4 mm conductors or two 50 x 5 mm bus bars
Variation of the position of the conductor in the clamp	< 0,5%, DC to 440 Hz
Adjacent conductor carrying alternating current	< 10 mA/A, at 50/60 Hz
Safety	IEC 61010-2-032, Pollution degree 2, 300 V CAT IV, 600 V CAT III

Table 19

Note: Currents < 1 A_{AC/DC} will be set to zero in AC distribution systems.

c) C193 clamp

C193 clamp	
Nominal Range	1000 A _{AC} for f ≤ 1 kHz
Measurement Range	0.5 to 1200 A _{AC} max (I > 1000 A more than 5 minutes)
Maximum Clamping Diameter	52 mm
Variation of the position of the conductor in the clamp	< 0,1%, DC to 440 Hz
Adjacent conductor carrying alternating current	< 0,5 mA/A, at 50/60 Hz
Safety	IEC 61010-2-032, Pollution degree 2, 600 V CAT IV, 1000 V CAT III

Table 20

Note: Currents < 0.5 A will be set to zero.

d) AmpFLEX® A193

AmpFLEX® A193	
Nominal Range	100/400/2000/10000 A _{AC}
Measurement Range	0.05 to 12000 A _{AC}
Maximum Clamping Diameter	Length = 450 mm; Ø = 120 mm Length = 800 mm; Ø = 235 mm
Variation of the position of the conductor in the sensor	≤ 2% any position and ≤ 4% near snap device
Adjacent conductor carrying alternating current	≤ 1% any position and ≤ 2% near snap device
Safety	IEC 61010-2-032, Pollution degree 2, 600 V CAT IV, 1000 V CAT III

Table 21

Note: Currents < 0.05% of the nominal range will be set to zero.
The nominal ranges are reduced to 50/200/1000/5000 A_{AC} at 400 Hz.

e) MN93 clamp

MN93 clamp	
Nominal Range	200 A _{AC} for f ≤ 1 kHz
Measurement Range	0.5 to 240 A _{AC} max (I > 200 A not permanent)
Maximum Clamping Diameter	20 mm
Variation of the position of the conductor in the clamp	< 0,5%, at 50/60 Hz
Adjacent conductor carrying alternating current	≤ 15 mA/A
Safety	IEC 61010-2-032, Pollution degree 2, 300 V CAT IV, 600 V CAT III

Table 22

Note: Currents < 100 mA will be set to zero.

f) MN93A clamp

MN93A clamp	
Nominal Range	5 A and 100 A _{AC}
Measurement Range	5 A: 0.01 to 6 A _{AC} max; 100 A: 0.2 A to 120 A _{AC} max
Maximum Clamping Diameter	20 mm
Variation of the position of the conductor in the clamp	< 0,5%, at 50/60 Hz
Adjacent conductor carrying alternating current	≤ 15 mA/A, at 50/60 Hz
Safety	IEC 61010-2-032, Pollution degree 2, 300 V CAT IV, 600 V CAT III

Table 23

The 5 A range of the MN93A is designed to work with secondary current transformers.

Note: Currents < 2.5 mA x ratio on the 5 A range and < 50 mA on the 100 A range will be set to zero with this probe.

g) E3N clamp

E3N clamp	
Nominal Range	10 A _{AC/DC} , 100 A _{AC/DC}
Measurement Range	0.01 to 100 A _{AC/DC}
Maximum Clamping Diameter	11.8 mm
Variation of the position of the conductor in the clamp	< 0,5%
Adjacent conductor carrying alternating current	-33 dB typical, DC to 1 kHz
Safety	IEC 61010-2-032, Pollution degree 2, 300 V CAT IV, 600 V CAT III

Table 24

Note: Currents < 50 mA will be set to zero in AC distribution systems.

h) J93 and J193 clamps

J93 and J193 clamps	
Nominal Range	3500 A _{AC} , 5000 A _{DC}
Measurement Range	50 - 3500 A _{AC} ; 50 - 5000 A _{DC}
Maximum Clamping Diameter	72 mm
Variation of the position of the conductor in the clamp	< ± 2%
Adjacent conductor carrying alternating current	> 35 dB typical, DC to 2 kHz
Safety	IEC 61010-2-032, Pollution degree 2, 600 V CAT IV, 1000 V CAT III

Table 25

Note: Currents < 5 A will be set to zero in AC distribution systems.

i) 5A adapter box/Essailec® adapter

5 A adapter box / Essailec® adapter	
Nominal Range	5 A _{AC}
Measurement Range	0.005 to 6 A _{AC}
Number of transformer inputs	3
Safety	IEC 61010-2-032, Pollution degree 2, 300 V CAT III

Table 26

Note: Currents < 2.5 mA will be set to zero.

5.2.4.3. Intrinsic uncertainty

The intrinsic uncertainties of the current and phase measured by the sensor must be added to the intrinsic uncertainties of the instrument for the quantity concerned (power, energy, power factor, $\tan \Phi$, etc.).

The following specifications are considered to be in the conditions of references of the current sensor.

Current sensors with 1 V output at Inom specifications

Sensor type	I nominal	Current (RMS or DC)	Intrinsic uncertainty at 50/60 Hz	Intrinsic uncertainty on φ at 50/60 Hz	Typical uncertainty on φ at 50/60 Hz	Typical uncertainty on φ at 400 Hz
PAC193 clamp	1000 ADC	[1 A; 50 A[$\pm 1.5\% \pm 1 \text{ A}$	-	-	- 4.5°@ 100 A
		[50 A; 100 A[$\pm 1.5\% \pm 1 \text{ A}$	$\pm 2.5^\circ$	-0.9°	
		[100 A; 800 A[$\pm 2.5\%$	$\pm 2^\circ$	- 0.8°	
]800 A; 1000 A[$\pm 4\%$		- 0.65°	
C193 clamp	1000 AAC	[1 A; 50 A[$\pm 1\%$	-	-	+ 0.1°@ 1000 A
		[50 A; 100 A[$\pm 0.5\%$	$\pm 1^\circ$	+ 0.25°	
]100 A; 1200 A[$\pm 0.3\%$	$\pm 0.7^\circ$	+ 0.2°	
MN93 clamp	200 AAC	[0,5 A; 5 A[$\pm 3\% \pm 1 \text{ A}$	-	-	-
		[5 A; 40 A[$\pm 2.5\% \pm 1 \text{ A}$	$\pm 5^\circ$	+ 2°	- 1.5°@ 40 A
		[40 A; 100 A[$\pm 2\% \pm 1 \text{ A}$	$\pm 3^\circ$	+ 1.2°	- 0.8°@ 100 A
]100 A; 240 A[$\pm 1\% + 1 \text{ A}$	$\pm 2.5^\circ$	$\pm 0.8^\circ$	- 1°@ 200 A
MN93A clamp	100 AAC	[200 mA; 5 A[$\pm 1\% \pm 2 \text{ mA}$	$\pm 4^\circ$	-	-
		[5 A; 120 A[$\pm 1\%$	$\pm 2.5^\circ$	+ 0.75°	- 0.5°@100 A
	5 AAC	[5 mA; 250 mA[$\pm 1.5\% \pm 0,1 \text{ mA}$	-	-	-
]255 mA; 6 A[$\pm 1\%$	$\pm 5^\circ$	+ 1.7°	- 0.5°@ 5 A
E3N clamp	100 AAC/DC	[5 A; 40 A[$\pm 4\% \pm 50 \text{ mA}$	$\pm 1^\circ$	-	-
		[40 A; 100 A[$\pm 15\%$	$\pm 1^\circ$	-	-
	10 AAC/DC	[50 mA; 250 A[$\pm 3\% \pm 50 \text{ mA}$	$\pm 1.5^\circ$	-	-
J93 J193 clamps	3500 AAC 5000 ADC	[50 A; 100 A[$\pm 2\% \pm 2.5 \text{ A}$	$\pm 4^\circ$	-	-
		[100 A; 500 A[$\pm 1.5\% \pm 2.5 \text{ A}$	$\pm 2^\circ$	-	-
		[500 A; 3500 A[$\pm 1\%$	$\pm 1.5^\circ$	-	-
]3500 ADC; 5000 ADC[$\pm 1\%$	-	-	-
5A / Essailec® Adapter	5 AAC	[5 mA; 250 mA[$\pm 0.5\% \pm 2 \text{ mA}$	$\pm 0.5^\circ$	-	-
]250 mA; 6 A[$\pm 0.5\% \pm 1 \text{ mA}$	$\pm 0.5^\circ$		

Table 27

AmpFLEX® and MiniFLEX® specifications

Sensor type	I nominal	Current (RMS or DC)	Typical intrinsic uncertainty at 50/60 Hz	Intrinsic uncertainty at 400 Hz	Intrinsic uncertainty on φ at 50/60 Hz	Typical uncertainty on φ at 400 Hz
AmpFLEX® A193 *	100 A _{AC}	[200 mA; 5 A[$\pm 1.2 \% \pm 50 \text{ mA}$	$\pm 2 \% \pm 0,1 \text{ A}$	-	-
		[5 A; 120 A[*	$\pm 1.2 \% \pm 50 \text{ mA}$	$\pm 2 \% \pm 0,1 \text{ A}$	$\pm 0.5^\circ$	- 0.5°
	400 A _{AC}	[0,8 A; 20 A[$\pm 1.2 \% \pm 0.2 \text{ A}$	$\pm 2 \% \pm 0,4 \text{ A}$	-	-
		[20 A; 500 A[*	$\pm 1.2 \% \pm 0.2 \text{ A}$	$\pm 2 \% \pm 0,4 \text{ A}$	$\pm 0.5^\circ$	- 0.5°
	2000 A _{AC}	[4 A; 100 A[$\pm 1.2 \% \pm 1 \text{ A}$	$\pm 2 \% \pm 2 \text{ A}$	-	-
		[100 A; 2400 A[*	$\pm 1.2 \% \pm 1 \text{ A}$	$\pm 2 \% \pm 2 \text{ A}$	$\pm 0.5^\circ$	- 0.5°
10,000 A _{AC}	[20 A; 500 A[$\pm 1.2 \% \pm 5 \text{ A}$	$\pm 2 \% \pm 10 \text{ A}$	-	-	
	[500 A; 12000 A[*	$\pm 1.2 \% \pm 5 \text{ A}$	$\pm 2 \% \pm 10 \text{ A}$	$\pm 0.5^\circ$	- 0.5°	
MiniFLEX® MA193 *	100 A _{AC}	[200 mA; 5 A[$\pm 1 \% \pm 50 \text{ mA}$	$\pm 2 \% \pm 0,1 \text{ A}$	-	-
		[5 A; 120 A[*	$\pm 1 \% \pm 50 \text{ mA}$	$\pm 2 \% \pm 0,1 \text{ A}$	$\pm 0.5^\circ$	- 0.5°
	400 A _{AC}	[0,8 A; 20 A[$\pm 1 \% \pm 0.2 \text{ A}$	$\pm 2 \% \pm 0,4 \text{ A}$	-	-
		[20 A; 500 A[*	$\pm 1 \% \pm 0.2 \text{ A}$	$\pm 2 \% \pm 0,4 \text{ A}$	$\pm 0.5^\circ$	- 0.5°
	2000 A _{AC}	[4 A; 100 A[$\pm 1 \% \pm 1 \text{ A}$	$\pm 2 \% \pm 2 \text{ A}$	-	-
		[100 A; 2,400 A[*	$\pm 1 \% \pm 1 \text{ A}$	$\pm 2 \% \pm 2 \text{ A}$	$\pm 0.5^\circ$	- 0.5°

Table 28

*: The nominal ranges are reduced to 50/200/1000/5000 A_{AC} at 400 Hz.

5.3. BLUETOOTH

Bluetooth 2.1,
Class 1 (range: 100 m)
Nominal output power: +15 dBm
Nominal sensitivity: -82 dBm
Rate: 115,2 kbits/s

5.4. POWER SUPPLY

AC Power (external power supply)

- **Operating Range:** 110 - 250 V @ 50/60 Hz
- **Max Power:** 30 VA

Battery Power

- **Type:** Rechargeable NiMH battery
- **Charge Time:** 5 hours approx
- **Recharging Temperature:** 10° to 40°C



Note: When the instrument is off, the real-time clock is saved for more than 2 weeks.

Autonomy

- 30 minutes minimum
- 60 minutes typical

5.5. MECHANICAL SPECIFICATIONS

- **Dimensions:** 256 x 125 x 37 mm
- **Weight:** < 1 kg
- **Drop Test:** 1 m in the most severe position without permanent mechanical damage or functional deterioration
- **Degrees of protection:** provided by enclosure (IP code) according to IEC 60529
 IP 54 instrument not connected (de-energised)
 IP20 instrument connected (operating)

5.6. ENVIRONMENTAL SPECIFICATIONS

- **Altitude: Operating:**
 - 0 to 2000 m;
 - Non-Operating: 0 to 10000 m
- **Temperature and % RH:**

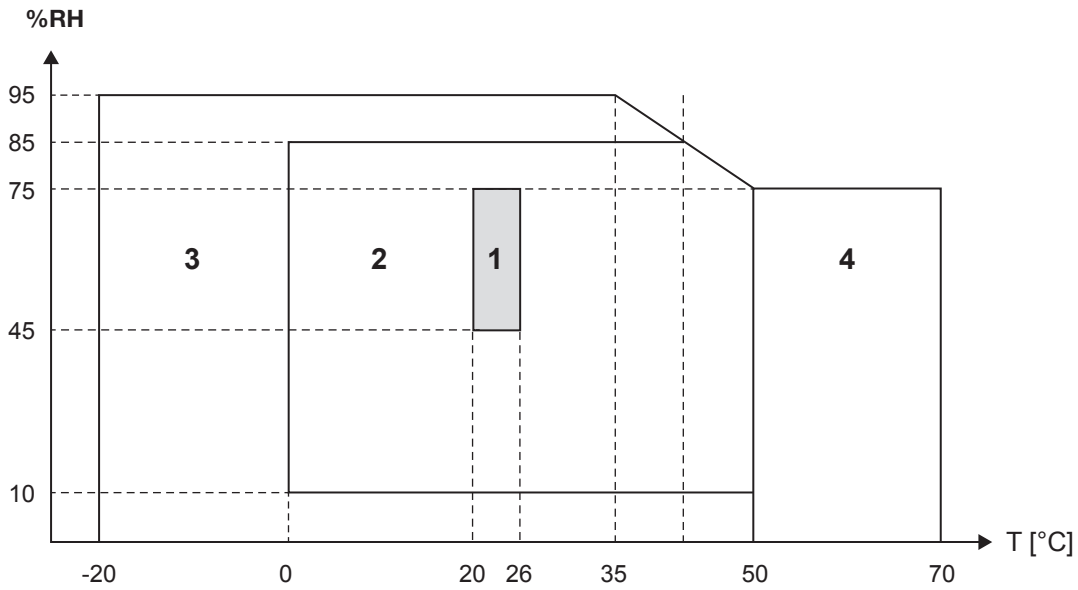

Figure 55

- 1= Range of reference
- 1+2= Operating range
- 1+2+3= Storage range with batteries
- 1+2+3+4= Storage range without batteries

5.7. SAFETY SPECIFICATIONS

The instrument complies with IEC 61010-1 and IEC 61010-2-030 for the following:

- Measurement inputs and enclosure: 600 V CAT IV / 1000 V CAT III, pollution degree 2
- Power supply: 300 V overvoltage category II, pollution degree 2



Conforms to UL Std. UL 61010-1
 Conforms to UL Std. UL 61010-2-030
 Cert. to CAN/CSA Std. C22.2 No. 61010-1-12
 Cert. to CSA Std. C22.2#61010-2-030

For the current sensors, see § 5.2.4
 The current sensors comply with IEC 61010-2-032
 The test leads and crocodile clips comply with IEC 61010-031

5.8. ELECTROMAGNETIC COMPATIBILITY

Emissions and immunity in an industrial setting compliant with IEC 61326-1.
 With an influence of 0,5 % typical of the full scale (5 A maximum).

6. MAINTENANCE



The instrument contains no parts that can be replaced by personnel who have not been specially trained and accredited. Any unauthorized repair or replacement of a part by an “equivalent” may gravely impair safety.

6.1. BATTERY

Your instrument is equipped with an NiMH battery. This technology offers several advantages:

- Long battery charge life for a limited volume and weight.
- Significantly reduced memory effect: you can recharge your battery even if it is not fully discharged.
- Respect for the environment: no pollutant materials such as lead or cadmium, in compliance with the applicable regulations.

After prolonged storage, the battery may be completely discharged. If so, it must be completely recharged.

Your instrument may be unable to function during part of this recharging operation.

Full recharging of a completely discharged battery may take several hours.



In this case, at least 5 charge/discharge cycles will be necessary for your battery to recover 95% of its capacity.

To make the best possible use of your battery and extend its effective service life:

- Only charge your instrument at temperatures between 10°C and 40°C (50°F and 104°F).
- Comply with the conditions of use.
- Comply with the storage conditions.

6.2. BATTERY INDICATOR

The Yellow/Red LED (#6 - see Table 4) indicates the status of the battery. When power is on, the battery is charged until it is full.

- LED OFF: Battery full (with or without power supply)
- Yellow LED ON/Not blinking: Battery is charging
- Yellow LED blinks twice per second: Battery is being recharged after a full discharge
- Red LED blinks twice per second: Low battery (and no power supply)

6.3. CLEANING



Disconnect the instrument from any source of electricity.

Use a soft cloth, dampened with soapy water. Rinse with a damp cloth and dry rapidly with a dry cloth or forced air. Do not use alcohol, solvents, or hydrocarbons.

Do not use the instrument if the terminals or keyboard are wet. Dry it first.

For the current sensors:

- Make sure that no foreign body interferes with the operation of the snap device of the sensor.
- Keep the clamp jaws as clean as possible. Do not splash water directly on the clamp

6.4. METROLOGICAL CHECK



Like all measuring or testing devices, the instrument must be checked regularly.

This instrument should be checked at least once a year. For checking and calibration, contact one of our accredited metrology laboratories (information and contact details available on request), at our Chauvin Arnoux subsidiary or the branch in your country.

6.5. REPAIR

For all repairs before or after expiry of warranty, please return the device to your distributor.

Authorized (competent and accredited) personnel must completely disconnect the instrument before any intervention.

6.6. UPDATING OF THE INTERNAL SOFTWARE

With a view to providing, at all times, the best possible service in terms of performance and technical upgrades, Chauvin Arnoux invites you to update the embedded software of the device by downloading the new version, available free of charge on our web site.

Our site:

<http://www.chauvin-arnoux.com>

Sign in and open your account.

Then go to “Software support space”, then “Freely available software”, then “PEL102/103”.

Connect the device to your PC using the USB cord provided.

Note: updating the embedded software could reset the configuration and causes the loss of the stored data. As a precaution, save the stored data to a PC before updating the embedded software.

7. WARRANTY

Except as otherwise stated, our warranty is valid for **twelve months** starting from the date on which the equipment was sold. Extract from our General Conditions of Sale provided on request.

The warranty does not apply in the following cases:

- Inappropriate use of the equipment or use with incompatible equipment;
- Modifications made to the equipment without the explicit permission of the manufacturer's technical staff;
- Work done on the device by a person not approved by the manufacturer;
- Adaptation to a particular application not anticipated in the definition of the equipment or not indicated in the user's manual;
- Damage caused by shocks, falls, or floods.

8. TO ORDER

8.1. PEL102/103 POWER & ENERGY LOGGER

PEL102 Power & Energy Logger	P01157152
PEL103 Power & Energy Logger	P01157153
PEL102 Power & Energy Logger with MiniFLEX®	P01157150
PEL103 Power & Energy Logger with MiniFLEX®	P01157151

The device is delivered with:

- 1 no. 23 carrying bag.
- 4 black safety cables, banana-banana straight-straight, 3 m long, attached with a Velcro tie.
- 4 black crocodile clips.
- 1 set of 12 inserts and rings to identify phases, voltage leads, and current sensors.
- 1 Type A-B USB cord 1.5m.
- 1 Mains cord 1.5m.
- 1 8GB SD-card (in the instrument).
- 1 USB SD-Card adapter.
- 1 MultiFix (universal mounting system)
- 1 CD with user's manuals and PEL Transfer software.
- 1 checking attestation.
- 1 Quick start guide.
- 1 safety sheet.

and, when the MiniFLEX® probes are included:

- 3 MiniFLEX® MA193 Current Sensors
- 1 MiniFLEX® safety sheet

8.2. ACCESSORIES

MiniFLEX MA193 250 mm	P01120580
MiniFLEX MA193 350 mm	P01120567
MN93 clamp	P01120425B
MN93A clamp	P01120434B
C193 clamp	P01120323B
AmpFLEX™ A193 450 mm	P01120526B
AmpFLEX™ A193 800 mm	P01120531B
PAC93 clamp	P01120079B
E3N clamp	P01120043A
BNC adapter for E3N clamp	P01102081
J93 clamp	P01120110
J193 clamp	P01120111
5 A adapter unit (three-phase)	P01101959
5 A adapter Essailec®	P01102131
Mains power unit + E3N clamp	P01120047
Dataview Software	P01102095
PEL mains adapter	P01102134

8.3. SPARE PARTS

USB-A USB-B cord	P01295293
Mains cord 1.5m	P01295174
No. 23 carrying bag.....	P01298078
Set of 4 black banana-banana straight-straight safety cables, 4 black crocodile clips and 12 inserts and rings to identify phases, voltage leads and current sensors	P01295476
MultiFix (universal mounting system)	P01021002

9. APPENDIX

9.1. MEASUREMENTS

9.1.1. DEFINITION

Calculations are done according to IEC 61557-12 and IEC 61010-4-30.

Geometric representation of active and reactive power:

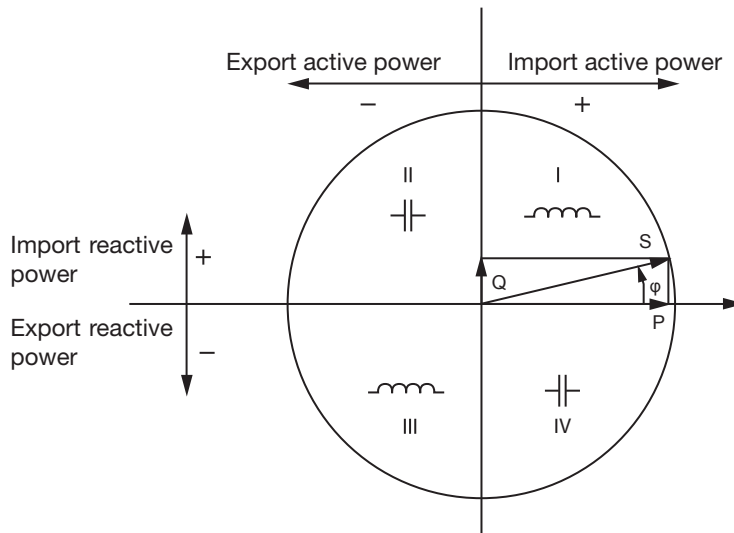

Figure 56

Diagram in accordance with clauses 12 and 14 of IEC 60375.

The reference of this diagram is the current vector (fixed on the right-hand part of the axis).

The voltage vector V changes its direction according to phase angle φ .

The phase angle φ between voltage V and current I is taken to be positive in the counterclockwise sense.

9.1.2. SAMPLING

9.1.2.1. Sampling Period

Depends on mains frequency: 50 Hz, 60 Hz or 400 Hz.

The sampling period is calculated every second.

- Mains frequency $f = 50$ Hz
 - From 42.5 to 57.5 Hz (50 Hz $\pm 15\%$), the sampling period is locked to the mains frequency. 128 samples are available for each mains cycle.
 - Outside the range 42.5 to 57.5 Hz, the sampling period is 128*50 Hz.
- Mains frequency $f = 60$ Hz
 - From 51 to 69 Hz (60 Hz $\pm 15\%$), the sampling period is locked to the mains frequency. 128 samples are available for each mains cycle.
 - Outside the range 51 to 69 Hz, the sampling period is 128*60 Hz.
- Mains frequency $f = 400$ Hz
 - From 340 to 460 Hz (400 Hz $\pm 15\%$), the sampling period is locked to the mains frequency. 16 samples are available for each mains cycle.
 - Outside the range 340 to 460 Hz, the sampling period is 16*400 Hz.

A pure DC measured signal is considered to be outside the frequency ranges. The sampling frequency is then, according to the preselected mains frequency, 6.4 kHz (50/400 Hz) or 7.68 kHz (60 Hz).

9.1.2.2. Locking of Sampling Frequency

- By default, the sampling frequency is locked to $V1$
- If $V1$ is missing, the sampling frequency attempts to lock to $V2$, then $V3$, $I1$, $I2$ and $I3$

9.1.2.3. AC/DC

The PEL makes AC and DC measurements for alternating current and direct current distribution systems. Selection of AC or DC is by the user.

AC +DC values are not available with PEL.

9.1.2.4. Measurement of Neutral Current

The PEL102 and PEL103 calculate the neutral current according to the distribution system.

9.1.2.5. "1-second" Quantities

The instrument calculates the following quantities every second, according to § 9.2.

"1-second" quantities are used for:

- Real-time values
- "1-second" trends
- Aggregation of values for "aggregated" trends (see § 9.1.2.6)
- Min and max determination for "aggregated" trends

All "1 second" quantities are saved on the SD-Card during the recording time.

9.1.2.6. Aggregation

An aggregated quantity is a value calculated for a defined period, according to the formulas specified in Table 30.

Aggregation periods always start on rounded hours/minutes. The aggregation period is the same for all quantities. The period is one of the following: 1, 2, 3, 4, 5, 6, 10, 12, 15, 20, 30 and 60mn.

All aggregated quantities are saved on the SD-Card during the recording session. They can be displayed in the PEL Transfer (see § 4.4).

9.1.2.7. Min and Max

Min and Max are the minimum and maximum values of the "1-second" quantities for the considered aggregation period in question. They are saved with the date and time of the Min and Max (see Table 30 for the available values). The Max aggregated values of some quantities are displayed directly.

9.1.2.8. Energy calculations

Energies are calculated every second.

The "Total" energy is the demand during the recording session.

The "Partial" energy can be determined during an integration period with the following values: 1 h, 1 day, 1 week, 1 month. The partial energy index is available only in real-time. It is not recorded.

However, the "Total" energy is available with the recording session data.

9.2. MEASUREMENT FORMULAS

PEL measures 128 samples per cycle (16 at 400 Hz) and calculates the voltage, current and active power quantities over one cycle.

PEL instruments calculate the aggregated value for 50 cycles (50 Hz), 66 cycles (60 Hz) or 400 cycles (400 Hz). ("1 second" quantities).

Quantities	Formula	Comments
AC RMS phase-to-neutral voltage (V_L)	$V_L[1s] = \sqrt{\frac{1}{N} \times \sum_1^N v_L^2}$	$v_L = v_1, v_2$ or v_3 elementary sample N = Number of samples
DC voltage (V_L)	$V_L[1s] = \frac{1}{N} \times \sum_1^N v_L$	L = v_1, v_2 or v_3 elementary sample N = Number of samples
AC RMS phase-to-phase voltage (U_L)	$U_{ab}[1s] = \sqrt{\frac{1}{N} \times \sum_1^N u_{ab}^2}$	ab = u_{12}, u_{23} or u_{31} elementary sample N = Number of samples
AC RMS Current (I_L)	$I_L[1s] = \sqrt{\frac{1}{N} \times \sum_1^N i_L^2}$	$i_L = i_1, i_2$ or i_3 elementary sample N = Number of samples
DC Current (I_L)	$I_L[1s] = \frac{1}{N} \times \sum_1^N i_L$	$i_L = i_1, i_2$ or i_3 elementary sample N = Number of samples
Voltage crest factor (V-CF)	$V-CF[1s] = \frac{1}{5} \times \sum_1^5 CF_{VL}$	CF_{VL} is the ratio of average crest values to the RMS value of 10/12 periods
Current crest factor (I-CF)	$I-CF[1s] = \frac{1}{5} \times \sum_1^5 CF_{IL}$	CF_{IL} is the ratio of average crest values to the RMS value of 10/12 periods
Unbalance (u_2) real-time only	$u_2[1s] = \sqrt{\frac{1 - \sqrt{3 - 6\beta}}{1 + \sqrt{3 - 6\beta}}}$	with $\beta = \frac{U_{2\ fund}^4 + U_{3\ fund}^4 + U_{3\ fund}^4}{(U_{1\ fund}^2 + U_{2\ fund}^2 + U_{3\ fund}^2)^2}$
Active Power (P_L)	$P_L[1s] = \frac{1}{N} \times \sum_1^N (v_L \times i_L)$	L = I_1, I_2 or I_3 elementary sample N = Number of samples $P_T[1s] = P_1[1s] + P_2[1s] + P_3[1s]$
Reactive Power (Q_L)	$Q_L[1s] = sign[1s] \times \sqrt{S_L^2[1s] - P_L^2[1s]}$	Reactive power includes harmonics. "sign[1s]" is the reactive power sign
	$Q_T[1s] = Q_1[1s] + Q_2[1s] + Q_3[1s]$	The total reactive power calculated $Q_T[1s]$ is a vector.
Apparent Power (S_L)	$S_L[1s] = V_L[1s] \times I_L[1s]$	
	$S_T[1s] = S_1[1s] + S_2[1s] + S_3[1s]$	The total apparent power $S_T[1s]$ is an arithmetic value
Power Factor (PF_L)	$PF_L[1s] = \frac{P_L[1s]}{S_L[1s]}$	
Cos φ_L	$\cos(\varphi_L)[1s] = \frac{1}{5} \times \sum_1^5 \cos(\varphi_L)[10/12]$	Cos $\varphi_L[10/12]$ is the cosine of the difference between the phase of the fundamental of the current I and the phase of the fundamental of the phase-to-neutral voltage V for 10/12 cycles values
Tan Φ	$tg(\varphi)[1s] = \frac{1}{5} \times \sum_1^5 \frac{Q[10/12]}{P[10/12]}$	$Q[10/12]$ and $P[10/12]$ are the 10/12-period values for Q and P.
Phase-to-neutral voltage harmonic distortion rate THD_VL (%)	$THD_V = 100 \times \sqrt{\frac{V_{eff}^2 - V_{H1}^2}{V_{H1}^2}}$	THD is calculated as % of fundamental VH1 is the value of the fundamental
Phase-to-phase voltage harmonic distortion level THD_Uab (%)	$THD_U = 100 \times \sqrt{\frac{U_{eff}^2 - U_{H1}^2}{U_{H1}^2}}$	THD is calculated as % of fundamental UH1 is the value of the fundamental
Current harmonic distortion level THD_IL (%)	$THD_I = 100 \times \sqrt{\frac{I_{eff}^2 - I_{H1}^2}{I_{H1}^2}}$	THD is calculated as % of fundamental IH1 is the value of the fundamental

Table 29

9.3. AGGREGATION

Aggregated quantities are calculated for a defined period according to the following formulas based on “1 second” values. They may be calculated by arithmetic or quadratic averaging, or other methods.

Quantities	Formula
Phase-to-neutral voltage (V_L) (RMS)	$V_L[agg] = \sqrt{\frac{1}{N} \times \sum_{x=0}^{N-1} V_{Lx}^2[1s]}$
Phase-to-neutral voltage (V_L) (DC)	$V_L[agg] = \frac{1}{N} \times \sum_{x=0}^{N-1} V_{Lx}[200ms]$
Phase-to-phase voltage (U_{ab}) (RMS)	$U_{ab}[agg] = \sqrt{\frac{1}{N} \times \sum_{x=0}^{N-1} U_{abx}^2[1s]}$ $ab = 12, 23 \text{ or } 31$
Current (I_L) (RMS)	$I_L[agg] = \sqrt{\frac{1}{N} \times \sum_{x=0}^{N-1} I_{Lx}^2[1s]}$
Current (I_L) (DC)	$I_L[agg] = \frac{1}{N} \times \sum_{x=0}^{N-1} I_{Lx}[200ms]$
Voltage crest factor (CF_{VL})	$CF_{VL}[agg] = \frac{1}{N} \times \sum_{x=0}^{N-1} CF_{VLx}[1s]$
Current crest factor (CF_{IL})	$CF_{IL}[agg] = \frac{1}{N} \times \sum_{x=0}^{N-1} CF_{ILx}[1s]$
Unbalance (u_2)	$u_2[agg] = \frac{1}{N} \times \sum_{x=0}^{N-1} u_{2x}[1s]$
Frequency (F)	$F[agg] = \frac{1}{N} \times \sum_{x=0}^{N-1} F_x[1s]$
Active Power exported (P_{SL})	$P_{SL}[agg] = \frac{1}{N} \times \sum_{x=0}^{N-1} P_{SLx}[1s]$
Active Power imported (P_{LL})	$P_{SL}[agg] = \frac{1}{N} \times \sum_{x=0}^{N-1} P_{SLx}[1s]$
Reactive Power exported (Q_{SL})	$Q_{SL}[agg] = \frac{1}{N} \times \sum_{x=0}^{N-1} Q_{SLx}[1s]$
Reactive Power imported (Q_{LL})	$Q_{RL}[agg] = \frac{1}{N} \times \sum_{x=0}^{N-1} Q_{RLx}[1s]$
Apparent Power (S_L)	$S_L[agg] = \frac{1}{N} \times \sum_{x=0}^{N-1} S_{Lx}[1s]$
Power Factor on source (PF_{SL}) with associated quadrant	$PF_{SL}[agg] = \frac{1}{N} \times \sum_{x=0}^{N-1} PF_{SLx}[1s]$
Active Power imported (P_{LL})	$P_{SL}[agg] = \frac{1}{N} \times \sum_{x=0}^{N-1} P_{SLx}[1s]$
Reactive Power exported (Q_{SL})	$Q_{SL}[agg] = \frac{1}{N} \times \sum_{x=0}^{N-1} Q_{SLx}[1s]$
Reactive Power imported (Q_{LL})	$Q_{RL}[agg] = \frac{1}{N} \times \sum_{x=0}^{N-1} Q_{RLx}[1s]$

Quantities	Formula
Apparent Power (S_L)	$S_L[agg] = \frac{1}{N} \times \sum_{x=0}^{N-1} S_{Lx}[1s]$
Export Power Factor (PF_{SL}) with associated quadrant	$PF_{SL}[agg] = \frac{1}{N} \times \sum_{x=0}^{N-1} PF_{SLx}[1s]$
Import Power Factor (PF_{RL}) with associated quadrant	$PF_{RL}[agg] = \frac{1}{N} \times \sum_{x=0}^{N-1} PF_{RLx}[1s]$
Cos (φ_L) _S at source with associated quadrant	$\text{Cos}(\varphi_L)_S[agg] = \frac{1}{N} \times \sum_{x=0}^{N-1} \text{Cos}(\varphi_L)_{Sx}[1s]$
Cos (φ_L) _L at load with associated quadrant	$\text{Cos}(\varphi_L)_R[agg] = \frac{1}{N} \times \sum_{x=0}^{N-1} \text{Cos}(\varphi_L)_{Rx}[1s]$
Tan Φ_S at source	$\text{Tan}(\varphi)_S[agg] = \frac{1}{N} \times \sum_{x=0}^{N-1} \text{Tan}(\varphi)_{Sx}[1s]$
Tan Φ_L at load	$\text{Tan}(\varphi)_R[agg] = \frac{1}{N} \times \sum_{x=0}^{N-1} \text{Tan}(\varphi)_{Rx}[1s]$
Phase-to-neutral voltage harmonic distortion level THD_V _L (%)	$THD_V_L[agg] = \frac{1}{N} \times \sum_{x=0}^{N-1} THD_V_{Lx}[1s]$
Phase-to-phase voltage harmonic distortion level THD_U _{ab} (%)	$THD_U_{ab}[agg] = \frac{1}{N} \times \sum_{x=0}^{N-1} THD_U_{abx}[1s]$
Current harmonic distortion level THD_I _L (%)	$THD_I_L[agg] = \frac{1}{N} \times \sum_{x=0}^{N-1} THD_I_k [1s]$

Table 30

Note: N is the number of “1 second” values for the considered aggregation period (1, 2, 3, 4, 5, 6, 10, 12, 15, 20, 30 or 60 min).

9.4. SUPPORTED ELECTRICAL NETWORKS

The following types of distribution systems are supported:

- V1, V2, V3 are the phase-to-neutral voltages of the installation under test [V1=VL1-N; V2=VL2-N; V3=VL3-N].
- Lower-case letters (v1, v2, v3) are used for sampled values
- U12, U23, U31 are the phase-to-phase voltages of the installation under test.
- Lower-case letters [u12 = v1-v2; u23= v2-v3, u31=v3-v1] are used for sampled values
- I1, I2, I3 are the currents flowing in the phase conductors of the installation under test.
- Lower-case letters i1, i2, i3 are used for sampled values

Distribution system	Abbreviation	Phase order	Comments	Reference diagram
Single phase (1-Phase 2-Wire)	1P- 2W	No	Voltage measurements are made between L1 and N. Current measurements are made on the L1 conductor.	see § 3.4.1
Dual phase (1-Phase 3-Wire)	1P-3W	No	Voltage measurements are made between L1, L2 and N. Current measurements are made on the L1 and L2 conductors. The neutral current is calculated: $i_N = i_1 + i_2$	see § 3.4.2

Distribution system	Abbreviation	Phase order	Comments	Reference diagram
3-Phase 3-Wire Δ [2 current sensors]	3P-3W Δ 2	Yes	The power measurement is made by the 2-wattmeter method with virtual neutral. Voltage measurements are made between L1, L2 and L3. Current measurements are made on the L1 and L3 conductors. The I2 current is calculated (no current sensor connected on L2): $i_2 = -i_1 - i_3$	see § 3.4.3.1
3-Phase 3-Wire Open Δ [2 current sensors]	3P-3WO2		The neutral is not available for the current and voltage measurements	see § 3.4.3.3
3-Phase 3-Wire Y [2 current sensors]	3P-3WY2			see § 3.4.3.5
3-Phase 3-Wire Δ [3 current sensors]	3P-3W Δ 3	Yes	The power measurement method is made by the 3 wattmeter method with virtual neutral. Voltage measurements are made between L1, L2 and L3. Current measurements are made on the L1, L2 and L3 conductors. The neutral is not available for the current and voltage measurements	see § 3.4.3.2
3-Phase 3-Wire Open Δ [3 current sensors]	3P-3WO3			see § 3.4.3.4
3-Phase 3-Wire Y [3 current sensors]	3P-3WY3			see § 3.4.3.6
3-Phase 3-Wire Δ balanced	3P-3W Δ B	No	The power measurement is made by the 1-wattmeter method. Voltage measurements are made between L1 and L2. Current measurements are made on L3 conductor. $U_{23} = U_{31} = U_{12}$. $I_1 = I_2 = I_3$	see § 3.4.3.7
3-Phase 4-Wire Y	3P-4WY	Yes	The power measurement method is made by the 3-wattmeter method with neutral. Voltage measurements are made between L1, L2 and L3. Current measurements are made on the L1, L2 and L3 conductors. The neutral current is calculated: $i_N = i_1 + i_2 + i_3$.	see § 3.4.4.1
3-Phase 4-Wire Y balanced	3P-4WYB	No	The power measurement is made by the single phase wattmeter method. Voltage measurements are made between L1 and N. Current measurements are made on the L1 conductor. $V_1 = V_2 = V_3$ $U_{23} = U_{31} = U_{12} = V_1 \times \sqrt{3}$. $I_1 = I_2 = I_3$	see § 3.4.4.2
3-Phase 4-Wire Y $2\frac{1}{2}$	3P-4WY2	Yes	This method is called the $2\frac{1}{2}$ element method. The power measurement method is made by the 3 wattmeter method with virtual neutral. Voltage measurements are made between L1, L3 and N. V2 is calculated: $v_2 = -v_1 - v_3$, $u_{12} = 2v_1 + v_3$, $u_{23} = -v_1 - 2v_3$. V2 is assumed to be balanced. Current measurements are made on the L1, L2 and L3 conductors. The neutral current is calculated: $i_N = i_1 + i_2 + i_3$	see § 3.4.4.3
3-Phase 4-Wire Δ	3P-4W Δ	No	The power measurement method is made by the 3-wattmeter method with neutral, but no power information for individual phases is available. Voltage measurements are made between L1, L2 and L3. Current measurements are made on the L1, L2 and L3 conductors.	see § 3.4.5.1
3-Phase 4-Wire Open- Δ	3P-4WO Δ		The neutral current is calculated for only one transformer branch: $i_N = i_1 + i_2$	see § 3.4.5.2
DC 2-Wire	DC-2W	No	Voltage measurements are made between L1 and N. Current measurements are made on the L1 conductor.	see § 3.4.6.1

Distribution system	Abbreviation	Phase order	Comments	Reference diagram
DC 3-Wire	DC-3W	No	Voltage measurements are made between L1, L2 and N. Current measurements are made on the L1 and L2 conductors. The negative (return) current is calculated: $i_N = i_1 + i_2$	see § 3.4.6.2
DC 4-Wire	DC-4W	No	Voltage measurements are made between L1, L2, L3 and N. Current measurements are made on the L1, L2 and L3 conductors. The negative (return) current is calculated: $i_N = i_1 + i_2 + i_3$	see § 3.4.6.3

Table 31

9.5. QUANTITIES ACCORDING TO THE SUPPLY SYSTEMS

● = YES □ = NO

Quantities		1P-2W	1P-3W	3P-3W Δ 2 3P-3WO2 3P-3WY2	3P-3W Δ 3 3P-3WO3 3P-3WY3	3P-3W Δ B	3P-4WY	3P-4WYB	3P-4WY2	3P-4W Δ 3P-4WO Δ	DC-2W	DC-3W	DC-4W
V_1	RMS	●	●				●	●	●	●			
V_2	RMS		●				●	●(1)	●(1)	●			
V_3	RMS						●	●(1)	●	●			
V_1	DC										●	●	●
V_2	DC											●	●
V_3	DC												●
U_{12}	RMS		●	●	●	●	●	●(1)	●(1)	●			
U_{23}	RMS			●	●	●(1)	●	●(1)	●(1)	●			
U_{31}	RMS			●	●	●(1)	●	●(1)	●	●			
I_1	RMS	●	●	●	●	●	●	●	●	●			
I_2	RMS		●	●(2)	●	●(1)	●	●(1)	●	●			
I_3	RMS			●	●	●(1)	●	●(1)	●	●			
I_N	RMS		●(2)				●(2)	●(4)	●(2)	●(2)			
I_1	DC										●	●	●
I_2	DC											●	●
I_3	DC												●
I_N	DC											●(2)	●(2)
V_{CF1}		●	●				●	●	●	●			
V_{CF2}			●				●	●(1)	●(1)	●			
V_{CF3}							●	●(1)	●	●			
I_{CF1}		●	●	●	●	●	●	●	●	●			
I_{CF2}			●	●(2)	●	●(1)	●	●(1)	●	●			
I_{CF3}				●	●	●(1)	●	●(1)	●	●			
u_2				●	●	●(4)	●	●(4)	●(4)	●(3)			
F		●	●	●	●	●	●	●	●	●			
P_1		●	●				●	●	●	●	●	●	●
P_2			●				●	●(1)	●(1)	●		●	●
P_3							●	●(1)	●	●			●
P_T		●(6)	●	●	●	●	●	●(1)	●	●	●(6)	●	●
P_1	Sour	●	●				●	●	●	●	●	●	●
P_2	Sour.		●				●	●(1)	●(1)	●		●	●

Quantities		1P-2W	1P-3W	3P-3W Δ 2 3P-3WO2 3P-3WY2	3P-3W Δ 3 3P-3WO3 3P-3WY3	3P-3W Δ B	3P-4WY	3P-4WYB	3P-4WY2	3P-4W Δ 3P-4WO Δ	DC-2W	DC-3W	DC-4W
P ₃	Sour.						●	●(1)	●	●			●
P _T	Sour.	●(6)	●	●	●	●	●	●(1)	●	●	●(6)	●	●
P ₁	Load	●	●				●	●	●	●	●	●	●
P ₂	Load		●				●	●(1)	●(1)	●		●	●
P ₃	Load						●	●(1)	●	●			●
P _T	Load	●(6)	●	●	●	●	●	●(1)	●	●	●(6)	●	●
Q ₁		●	●				●	●	●	●			
Q ₂			●				●	●(1)	●(1)	●			
Q ₃							●	●(1)	●	●			
Q _T		●(6)	●	●	●	●	●	●(1)	●	●			
Q ₁	Sour.	●	●				●	●	●	●			
Q ₂	Sour.		●				●	●(1)	●(1)	●			
Q ₃	Sour.						●	●(1)	●	●			
Q _T	Sour.	●(6)	●	●	●	●	●	●(1)	●	●			
Q ₁	Load	●	●				●	●	●	●			
Q ₂	Load		●				●	●(1)	●(1)	●			
Q ₃	Load						●	●(1)	●	●			
Q _T	Load	●(6)	●	●	●	●	●	●(1)	●	●			
S ₁		●	●				●	●	●	●			
S ₂			●				●	●(1)	●(1)	●			
S ₃							●	●(1)	●	●			
S _T		●(6)	●	●	●	●	●	●(1)	●	●			
PF ₁		●	●				●	●	●	●			
PF ₂			●				●	●(1)	●(1)	●			
PF ₃							●	●(1)	●	●			
PF _T		●(6)	●	●	●	●	●	●(1)	●	●			
PF ₁	Sour.	●	●				●	●	●	●			
PF ₂	Sour.		●				●	●(1)	●(1)	●			
PF ₃	Sour.						●	●(1)	●	●			
PF _T	Sour.	●(6)	●	●	●	●	●	●(1)	●	●			
PF ₁	Load	●	●				●	●	●	●			
PF ₂	Load		●				●	●(1)	●(1)	●			
PF ₃	Load						●	●(1)	●	●			
PF _T	Load	●(6)	●	●	●	●	●	●(1)	●	●			
Cos φ_1		●	●				●	●	●	●			
Cos φ_2			●				●	●(1)	●(1)	●			
Cos φ_3							●	●(1)	●	●			
Cos φ_T		●(6)	●	●	●	●	●	●(1)	●	●			
Cos φ_1	Sour.	●	●				●	●	●	●			
Cos φ_2	Sour.		●				●	●(1)	●(1)	●			
Cos φ_3	Sour.						●	●(1)	●	●			
Cos φ_M	Sour.	●(6)	●	●	●	●	●	●(1)	●	●			
Cos φ_1	Load	●	●				●	●	●	●			
Cos φ_2	Load		●				●	●(1)	●(1)	●			
Cos φ_3	Load						●	●(1)	●	●			
Cos φ_T	Load	●(6)	●	●	●	●(3)	●	●(1)	●	●			

Quantities		1P-2W	1P-3W	3P-3W Δ 2 3P-3WO2 3P-3WY2	3P-3W Δ 3 3P-3WO3 3P-3WY3	3P-3W Δ B	3P-4WY	3P-4WYB	3P-4WY2	3P-4W Δ 3P-4WO Δ	DC-2W	DC-3W	DC-4W
Tan Φ		●	●	●	●	●(3)	●	●	●(1)	●			
Tan Φ	Sour.	●	●	●	●	●(3)	●	●	●	●			
Tan Φ	Load	●	●	●	●	●(3)	●	●	●	●			
Hi_V ₁	i=1 to 50 (5)	●	●				●	●	●	●			
Hi_V ₂			●				●	●(1)	●	●			
Hi_V ₃							●	●(1)	●	●			
Hi_U ₁₂	i=0 to 50 (5)		●	●	●	●	●	●(1)	●(1)	●			
Hi_U ₂₃				●	●	●(1)	●	●(1)	●(1)	●			
Hi_U ₃₁				●	●	●(1)	●	●(1)	●	●			
Hi_I ₁	i=0 to 50 (5)	●	●	●	●	●	●	●	●	●			
Hi_I ₂			●	●(2)	●	●(1)	●	●(1)	●	●			
Hi_I ₃				●	●	●(1)	●	●(1)	●	●			
Hi_I _N			●(2)				●(2)	●(4)	●(2)	●(2)			
THD_V ₁		●	●				●	●	●	●			
THD_V ₂			●				●	●(1)	●(1)	●			
THD_V ₃							●	●(1)	●	●			
THD_U ₁₂			●	●	●	●	●	●(1)	●(1)	●			
THD_U ₂₃				●	●	●(1)	●	●(1)	●(1)	●			
THD_U ₃₁				●	●	●(1)	●	●(1)	●	●			
THD_I ₁		●	●	●	●	●	●	●	●	●			
THD_I ₂			●	●(2)	●	●(1)	●	●(1)	●	●			
THD_I ₃				●	●	●(1)	●	●(1)	●	●			
THD_I _N			●(2)				●(2)	●(4)	●(2)	●(2)			

(1) Extrapolated

(2) Calculated

(3) Not a significant value

(4) Always = 0

(5) Rank 7 for 400 Hz

(6) $P_1 = P_T$, $\varphi_1 = \varphi_T$, $S_1 = S_T$, $PF_1 = PF_T$, $\cos \varphi_1 = \cos \varphi_T$

9.6. GLOSSARY

φ Phase shift of the phase-to-neutral voltage with respect to the phase-to-neutral current.

$\overset{\curvearrowright}{\equiv}$ Inductive phase shift.

$\overset{\curvearrowleft}{\equiv}$ Capacitive phase shift.

° Degree.

% Percentage.

A Ampère (current unit).

Aggregation Different averages defined in § 9.3.

CF Crest factor (Peak Factor) in current or voltage: ratio of the peak value of a signal to the RMS value.

cos φ Cosine of the phase shift of the fundamental voltage with respect to the fundamental current.

DC DC component (current or voltage).

Ep Abbreviation for active energy.

Eq Abbreviation for reactive energy.

Es Abbreviation for apparent energy.

Frequency number of full voltage or current cycles in one second.

Fundamental component: component at the fundamental frequency.

Harmonics in electrical systems, voltages and currents at frequencies that are multiples of the fundamental frequency.

Hz Frequency of the network.

I	Abbreviation for current.
I-CF	Crest (peak) factor of current
I-THD	Total harmonic distortion of current
I_x-H_n	Current value or percentage for harmonic order n.
L	Phase of a polyphased electrical power network.
MAX	Maximum value.
Measurement method: Any measurement method associated with an individual measurement.	
MIN	Minimum value.
Nominal voltage: Reference voltage of a network.	
Order of a harmonic: ratio of the frequency of the harmonic to the fundamental frequency; a whole number.	
P	Abbreviation for active power.
PF	Power Factor: ratio of active power to apparent power.
Phase	temporal relationship between current and voltage in alternating current circuits.
Q	Abbreviation for reactive power.
RMS	RMS (Root Mean Square) value of current or voltage. Square root of the mean of the squares of the instantaneous values of a quantity during a specified interval.
S	Abbreviation for apparent power.
tan φ	Ratio of reactive power to active power.
THD	Total Harmonic Distortion. The total harmonic distortion describes the proportion of the harmonics of a signal with respect to the RMS value of the fundamental or to the total RMS value without DC.
U	Phase-to-phase voltage.
U-CF	Phase-to-phase voltage crest factor
u₂	Phase-to-neutral voltage unbalance.
U_x-H_n	Phase-to-phase voltage (value or percentage) for harmonic order n.
U_{xy}-THD	Total phase-to-phase voltage harmonic distortion
V	Abbreviation for phase-to-neutral voltage or the unit "volt".
V-CF	Voltage crest (peak) factor
VA	Apparent power unit (Volt-Ampere).
var	Reactive power unit.
varh	Reactive energy unit.
V-THD	Total harmonic distortion of phase-to-neutral voltage.
Voltage unbalance in a polyphased electrical power network: State in which the RMS voltages between conductors (fundamental component) and/or the phase differences between successive conductors are not equal.	
V_x-H_n	Phase-to-neutral voltage (value or percentage) for harmonic order n.
W	Active power unit (Watt).
Wh	Active energy unit (Watt-hour).

Prefixes of International System (SI) units

Prefix	Symbol	Multiplies by
milli	m	10 ⁻³
kilo	k	10 ³
Mega	M	10 ⁶
Giga	G	10 ⁹
Tera	T	10 ¹²
Peta	P	10 ¹⁵
Exa	E	10 ¹⁸



05 - 2015

Code 693780A02 - Ed. 7

DEUTSCHLAND - Chauvin Arnoux GmbH

Ohmstraße 1 - 77694 Kehl / Rhein
Tel: (07851) 99 26-0 - Fax: (07851) 99 26-60

UNITED KINGDOM - Chauvin Arnoux Ltd

Unit 1 Nelson Ct - Flagship Sq - Shaw Cross Business Pk
Dewsbury, West Yorkshire - WF12 7TH
Tel: 01924 460 494 - Fax: 01924 455 328

ITALIA - Amra SpA

Via Sant' Ambrogio, 23/25 - 20846 Macherio (MB)
Tel: 039 245 75 45 - Fax: 039 481 561

ÖSTERREICH - Chauvin Arnoux Ges.m.b.H

Slamastrasse 29/2/4 - 1230 Wien
Tel: 01 61 61 9 61-0 - Fax: 01 61 61 9 61-61

SCANDINAVIA - CA Mätssystem AB

Sjöflygvägen 35 - SE 18304 TÄBY
Tel: +46 8 50 52 68 00 - Fax: +46 8 50 52 68 10

SCHWEIZ - Chauvin Arnoux AG

Moosacherstrasse 15 - 8804 AU / ZH
Tel: 044 727 75 55 - Fax: 044 727 75 56

中国 - 上海浦江埃纳迪斯仪表有限公司

上海市虹口区祥德路381号3号楼3楼
Tel: +86 21 65 21 51 96 - Fax: +86 21 65 21 61 07

ESPAÑA - Chauvin Arnoux Ibérica S.A.

C/ Roger de Flor, 293 - 1a Planta - 08025 Barcelona
Tel: 90 220 22 26 - Fax: 93 459 14 43

MIDDLE EAST - Chauvin Arnoux Middle East

P.O. BOX 60-154 - 1241 2020 JAL EL DIB (Beirut) - LEBANON
Tel: (01) 890 425 - Fax: (01) 890 424

USA - Chauvin Arnoux Inc - d.b.a AEMC Instruments

200 Foxborough Blvd. - Foxborough - MA 02035
Tel: (508) 698-2115 - Fax: (508) 698-2118

<http://www.chauvin-arnoux.com>

190, rue Championnet - 75876 PARIS Cedex 18 - FRANCE

Tél. : +33 1 44 85 44 85 - Fax : +33 1 46 27 73 89 - info@chauvin-arnoux.fr

Export : Tél. : +33 1 44 85 44 38 - Fax : +33 1 46 27 95 59 - export@chauvin-arnoux.fr