

SIKA Simulators MC75 Multifunction Process Calibrator

Instruction Manual

Version V03



SIKA Dr. Siebert & Kühn GmbH & Co. KG
Struthweg 7-9
34260 Kaufungen
Germany

Tel +49-05605-803-0
Fax +49-5605-803-54
eMail info@SIKA.net
web www.SIKA.net

We are very grateful to you for choosing this SIKA accuracy measuring instrument which benefits from our hundred years experience in the manufacture of high quality, accuracy measuring instruments.

Because of this, we are able to continue our policy of continuous innovation which has served our customers so well for the last 100 years. SIKA encourages your comments and would willingly accept any suggestions from you to help us to perfect our know-how and improve our future products.

LIMIT OF GUARANTEE AND LIMIT OF RESPONSIBILITY

SIKA guarantees the absence of faulty materials and the manufacture of this product under normal conditions of use and maintenance. The guarantee period is one year and takes effect on the date of delivery. Parts, repairs to the product and service are guaranteed for a period of 90 days. This guarantee only applies to the original purchaser or the end user if he is a client of a SIKA approved distributor and does not cover fuses, interchangeable batteries/cells nor any product which, in the opinion of SIKA, has been badly handled, modified, neglected or damaged by accident or subjected to abnormal conditions of use or handling. SIKA guarantees that the software will function largely in accordance with its functional specifications for a period of 90 days and that it has been correctly recorded on non-defective media. SIKA does not guarantee that the software contains no errors or that it will operate without interruption.

SIKA approved distributors shall apply this guarantee to products sold to new clients it has not served, but are not authorised to offer a longer or different guarantee in the name of SIKA. Guarantee support is offered if the product was purchased by an intermediary from an SIKA approved point of sale or if the purchaser has paid the applicable international price. SIKA reserves the right to invoice the purchaser for the costs of importing, repair or replacement parts if the product purchased in one country was sent to another country for repair.

The obligations under the guarantee of SIKA are limited at the discretion of SIKA, to reimbursement of the purchase price, or the free repair/replacement of a defective product returned within the period of the guarantee to an SIKA approved service centre.

To claim for service under the guarantee, contact the nearest SIKA agent or send the product, accompanied by a description of the problem, carriage and insurance paid (free on board destination), to the nearest SIKA approved service centre. SIKA declines any responsibility in the event of damage occurring during transportation. After repair under guarantee, the product will be returned to the purchaser, carriage paid (free on board destination). If SIKA considers that the problem was caused by abusive treatment, modification, an accident or abnormal conditions of operation or handling, SIKA will submit a quotation for the cost of repair and will only commence the repair after receiving authorisation. After repair, the product will be returned to the purchaser, carriage paid, and the costs of repair and transportation will be invoiced to him.

THIS GUARANTEE IS EXCLUSIVE AND REPLACES ANY OTHER GUARANTEES, EXPLICIT OR IMPLIED, INCLUDING, BUT NOT LIMITED TO, ANY IMPLIED GUARANTEE AS TO THE SUITABILITY OF THE PRODUCT TO BE SOLD OR APPLIED TO A PARTICULAR PURPOSE OR USE. SIKA SHALL NOT BE HELD RESPONSIBLE FOR ANY PARTICULAR INDIRECT, ACCIDENTAL OR CONSEQUENTIAL DAMAGE, NOR ANY CORRUPTED OR LOST DATA, WHETHER AS A RESULT OF AN INFRACTION OF THE OBLIGATIONS OF THE GUARANTEE, OR ON A CONTRACTUAL, EXTRA-CONTRACTUAL OR OTHER BASIS.

Because some countries or states do not permit limitations to an implied condition of guarantee, or the exclusion or limitation of accidental or consequential damage, the limitations and exclusions of this guarantee may not apply to every purchaser. If any condition of this guarantee is considered invalid or inapplicable by a competent court, such a decision will in no way affect the validity or binding nature of any other condition.

All MC 75 units are mechanically and electrically checked before delivery. The necessary precautions have been taken to ensure that they reach the user undamaged.

However, it is a good idea to make a brief check for any damage that may have occurred during transportation. If this is the case, make an immediate claim against the carrier.

The following accessories are standard:

- This user guide
- Mains unit for charging the battery pack
- 6 measurement cables
- Mounting strap

If the unit is to be returned, it is preferable to use the original packaging and state as clearly as possible, in a note attached to the unit, the reasons for its return.

Table of contents

A. GENERAL	6
A.1 INTRODUCTION.....	6
A.1.1 <i>About this guide</i>	6
A.2 INSTRUMENT.....	7
A.2.1 <i>General view of the unit</i>	7
A.2.2 <i>Sheath</i>	7
A.2.3 <i>Connection terminals</i>	8
A.2.4 <i>Side connectors</i>	8
A.2.5 <i>Screen</i>	9
A.2.6 <i>Keyboard</i>	9
A.2.7 <i>Batteries and charger</i>	10
A.2.8 <i>Replacing the battery pack</i>	10
A.2.9 <i>Stand</i>	11
A.2.10 <i>Strap</i>	11
A.3 GENERAL DESCRIPTION.....	11
A.3.1 <i>User Interface</i>	12
A.4 SAFETY.....	15
A.4.1 <i>Compliance with safety standards</i>	15
A.4.2 <i>Instructions</i>	15
A.4.3 <i>Making measurements</i>	16
A.4.4 <i>Unusual faults and stresses</i>	16
A.4.5 <i>Definitions</i>	16
A.5 SERVICE.....	17
A.5.1 <i>Recalibration/Maintenance</i>	17
A.5.2 <i>Cleaning</i>	17
B. GETTING STARTED	18
B.1 POWERING ON.....	18
B.2 MEASUREMENT.....	18
B.2.1 <i>Voltage measuring (DC)</i>	19
B.2.2 <i>Current measuring (DC)</i>	20
B.2.3 <i>Resistance measuring</i>	22
B.2.4 <i>Continuity test</i>	23
B.2.5 <i>Frequency measuring (signal)</i>	23
B.2.6 <i>Frequency measuring (dry contact)</i>	24
B.2.7 <i>Pulse counting</i>	24
B.2.8 <i>Temperature measuring (RTD)</i>	25
B.2.9 <i>Temperature measuring (Thermocouple)</i>	26
B.2.10 <i>Pressure measuring</i>	27
B.2.11 <i>Pressure switch test</i>	27
B.3 GENERATION/SIMULATION.....	29
B.3.1 <i>Voltage generation (DC)</i>	29
B.3.2 <i>Current generation (DC)</i>	30
B.3.3 <i>Resistance generation</i>	31
B.3.4 <i>Temperature simulation (RTD)</i>	32
B.3.5 <i>Temperature simulation (Thermocouple)</i>	32
B.3.6 <i>Frequency generation (signal)</i>	33
B.3.7 <i>Frequency generation (dry contact)</i>	34
B.3.8 <i>Pulse generation</i>	34

C.	ADVANCED OPERATION	36
C.1	SIMULATION MODES	36
C.1.1	Manual Editing	36
C.1.2	Incremental Editing	36
C.1.3	Predefined Settings	37
C.1.4	Steps	38
C.1.5	Simple Ramp	39
C.1.6	Cyclic Ramp	40
C.1.7	Synthesiser	41
C.1.8	Transmitter Mode	43
C.2	SCALING	43
C.3	NULL/TARE/OFFSET	44
C.4	CALIBRATED SENSORS	45
C.5	CALIBRATION PROCEDURE	47
C.6	MEMORY FUNCTIONS	51
C.7	CUSTOMER SPECIFIC CONFIGURATIONS	54
C.8	INSTRUMENT SETUP	56
C.8.1	Contrast	56
C.8.2	Date and Time	56
C.8.3	Preferences	57
D.	TECHNICAL SPECIFICATIONS	58
D.1	MEASUREMENT FUNCTION	58
D.1.1	Voltage measurement (DC)	58
D.1.2	Current measurement (DC)	58
D.1.3	Resistance measurement	58
D.1.4	Temperature measurement (Thermocouple)	59
D.1.5	Temperature measurement (RTDs)	60
D.1.6	Frequency measurement and counting	60
D.1.7	Additional features at measurement mode	60
D.2	TRANSMISSION / SIMULATION FUNCTION	61
D.2.1	Voltage generation (DC)	61
D.2.2	Current generation (DC)	61
D.2.3	Resistance generation	61
D.2.4	Temperature simulation (Thermocouple)	62
D.2.5	Temperature simulation (RTDs)	63
D.2.6	Frequency and pulses generation	63
D.2.7	Additional features at simulation mode	64

A. GENERAL

A.1 Introduction

The MC 75 is a multifunction calibrator. It is specially designed for calibration and maintenance and can measure and simulate physical and electrical quantities, either on site or in the laboratory.

It can perform all the following functions:

- Measure DC voltage and current, resistance and frequency/ counts and pressure.
- Measure temperatures using thermocouples and resistive probes.
- Supply power and measure a current loop which is compatible with the HART® protocol.
- Generate DC voltages and currents.
- Simulate resistance, thermocouples and resistive probes.
- Recording of measurements and their display as a table or trend curve.
- Calibration and generation of the calibration report.
- Possibility of using calibrated sensors with memorisation of the calibration factors

Measurement and transmission can take place simultaneously, with a double display.

The MC 75 has many associated functions that extend its range of application:

- Relative measurement.
- Results displayed based on a linear or other conversion law.
- Generation of increments and simple or cyclic ramps.
- Synthesis of curves.

A number of improvements have provided it with:

- Rapid access to all its functions.
- Intuitive user interface.
- Advanced on-line help system.
- Multi-functions keys defined step-by-step on the display.
- Connections which can be made with 4 mm safety plugs.
- Protection against overloads.
- Powered by a rechargeable battery with rapid internal charger.

The unit is enclosed in an ABS case with rubber sheath.

A.1.1 About this guide

This user guide consists of four parts: A, B, C and D.

Part A contains general information and a description of the hardware and software of the unit. It also contains a paragraph on safety and user precautions.

Part B contains brief handling information and a description of the various modes of operation.

Part C contains a description of the advanced functions.

Part D contains the technical specifications of the MC 75.

A.2 Instrument

General characteristics:

- Portable unit powered by a pack of Ni-MH, 1.8 Ah rechargeable batteries.
- Battery life: 5 to 10 hours, depending on the functions used.
- Stand for table mounting.
- Strap for carrying and on-site use.
- 240 x 320 pixel liquid crystal graphical display.
- Choice of language for messages and programming the functions, settings and parameters using a keyboard with 22 keys.
- Back-lit display controllable from a key on the keyboard, with automatic switch-off after a programmable time of inactivity.
- Battery charging: mains adaptor supplied with the unit or from any 10 to 14 VDC power supply.
- Adaptor characteristics: mains voltage 230 V \pm 10%, 50/60 Hz.
- Charging time: 3 h max.
- Case: ABS case with rubber sheath.
- Dimensions: 210 mm x 110 mm x 50 mm.
- Weight: 900 g with sheath and accessories
- Waterproof to IP 54 in accordance with standard EN 60529

A.2.1 General view of the unit

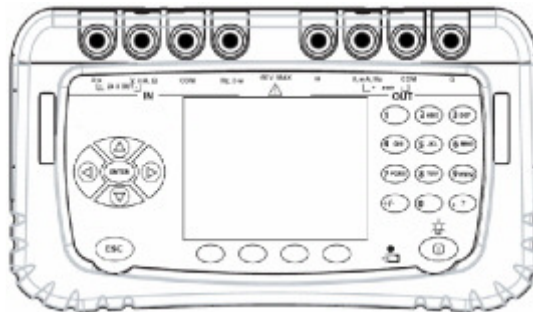

A.2.2 Sheath

The MC 75 is delivered with a rubber sheath fitted to the case. The sheath protects the unit from mechanical shocks and makes the side openings for the USB interface connector and the charger connector waterproof to IP54.

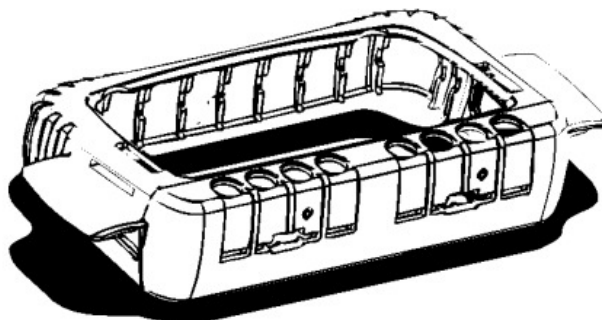

A.2.3 Connection terminals

Four terminals for connection for the "measurement" function (IN); two of which are reserved for 3 or 4 wire connection when measuring resistance, temperature with a resistive probe and current for a passive transmitter. Refer to paragraph B.2.

Four connection terminals for the "transmit/simulate" function (OUT).

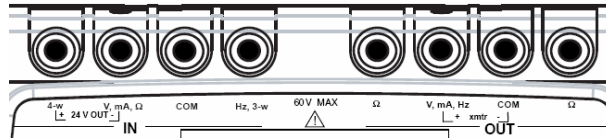

The 8 terminals of the MC 75 are of the "push & lock" type. They accept 4 mm banana plugs, bare wires, spade terminals and miniature connectors for thermocouples.

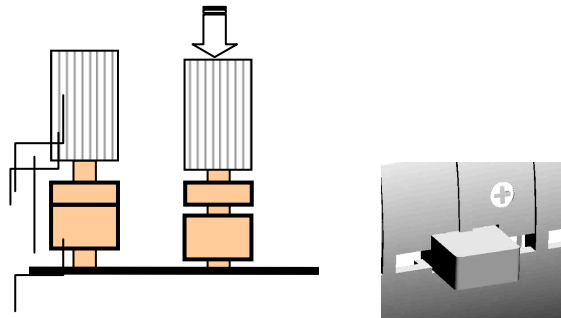

A.2.4 Side connectors

There are two connectors on the left hand side of the unit.

- The first is a mains unit connector for battery charging.
- The second is a type B USB socket for connection to a computer.



USB Socket

Charger Socket



The connector for the pressure sensor is located on the right-hand side of the unit.

Pressure sensor socket



A.2.5 Screen

The MC 75 is fitted with an LCD graphical display which is backlit with white LEDs. The resolution of the display is 240 x 320 pixels.

When the unit is in use, the screen comprises:

- A window displaying the programming of the "measurement" function parameters (IN). Refer to paragraph B.2.
- A window displaying the programming of the parameters of the "transmission/simulation" function (OUT).
- A strip showing the various menus accessible by touch keys directly on the screen.

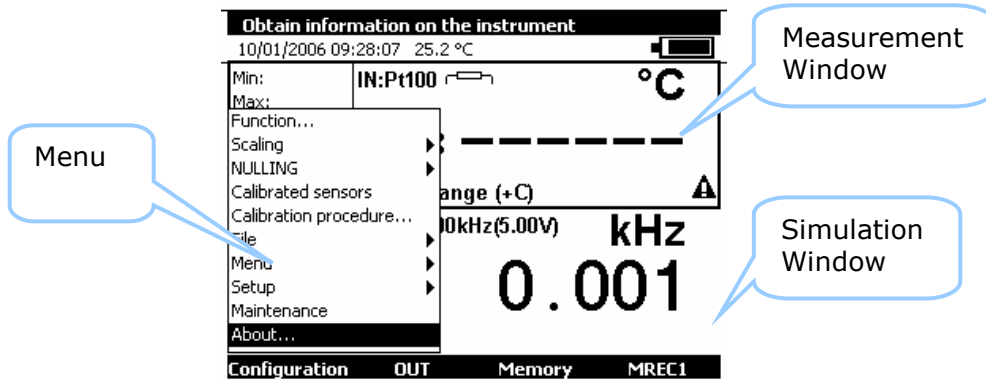

A.2.6 Keyboard

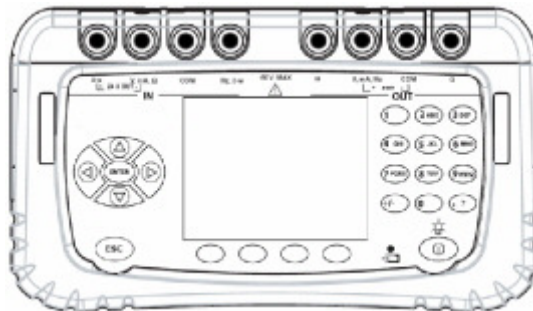

The keyboard contains:

- 4 blank function keys to select the various menus shown on the screen. Note: for the purposes of this manual, the buttons are referred to as F1, F2, F3 and F4 but are not labelled on the unit.

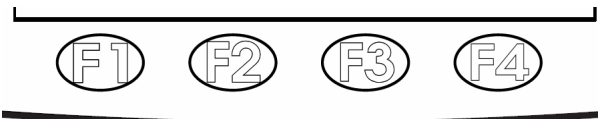

- A navigator:

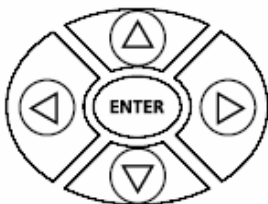

- A cancel key:



- A Start/stop key for the unit and back-lighting on/off key:



A short push switches the unit on. During operation, a short push switches the back-lighting on or off. A long push of 2 seconds switches the unit off.

- 12 alphanumeric keys for programming the parameters.

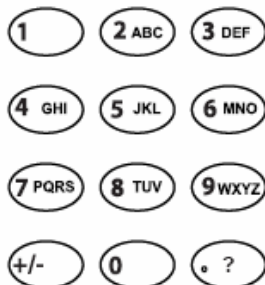



- AN LED to indicate the state of charge of the battery:



A.2.7 Batteries and charger

The MC 75 contains a rechargeable NiMH battery pack. When the symbol  blinks on the display, the battery should be recharged as soon as possible.

- Insert the charger plug into the connector on the side of the unit. See paragraph A.2.4.
- Connect the charger to the mains after checking that the mains voltage is correct. The charge indicator (red LED)  on the front begins to blink if the battery level is very low, then remains steady.
- Leave the charger switched on for about 3 hours.
- Disconnect the charger when the charge indicator on the front  goes off.

The unit can be used while the batteries are charging.



Warning

ONLY USE THE MAINS ADAPTOR SUPPLIED WITH THE CALIBRATOR.

The charger can be used with voltages of between 100 VAC and 250 VAC.

The charger is for indoor use only, at an ambient temperature not exceeding 40°C (104°F).

A.2.8 Replacing the battery pack

To replace the battery pack, contact your dealer.

A.2.9 Stand

The stand gives a good angle of view when the MC 75 is placed on a desk. Unfold the stand on the back of the unit and place the MC 75 on a desk as shown below.

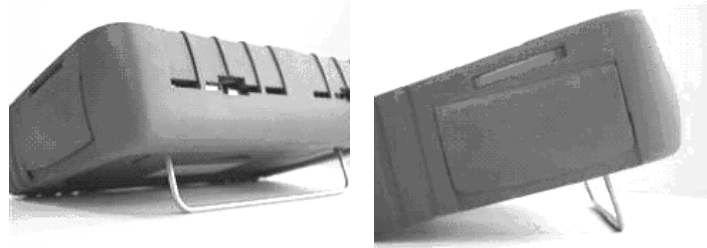

A.2.10 Strap

The MC 75 is supplied with an untearable strap and two pins to attach the strap to the case. Before attaching the strap, pass the free end through the fixing loop as in the diagram.

Feed the ends of the strap through the two slots on each side of the case. Insert the two pins into the strap and pull the strap to lock the pins in the case.



A.3 General Description

The diagram below briefly describes the functions of the firmware.

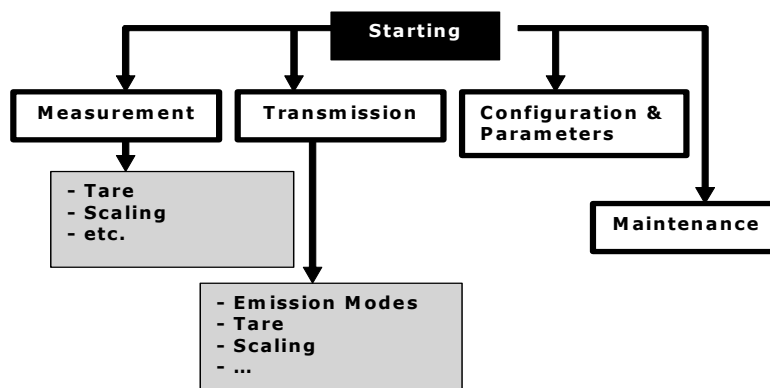

The Start procedure checks that the unit is working correctly and initialises the various tasks that are continuously executed during operation of the MC 75.

The Measurement task is responsible for the configuration, post-processing and display of measurements.

The Transmission task handles the various modes of simulation, pre-processing of settings and the display.

Several tasks are dedicated to setting parameters and configuration management.



The maintenance task is responsible for calibration and initialisation of the unit.

A real time operating system coordinates the various tasks and manages the keyboard and USB peripherals.

A.3.1 User Interface

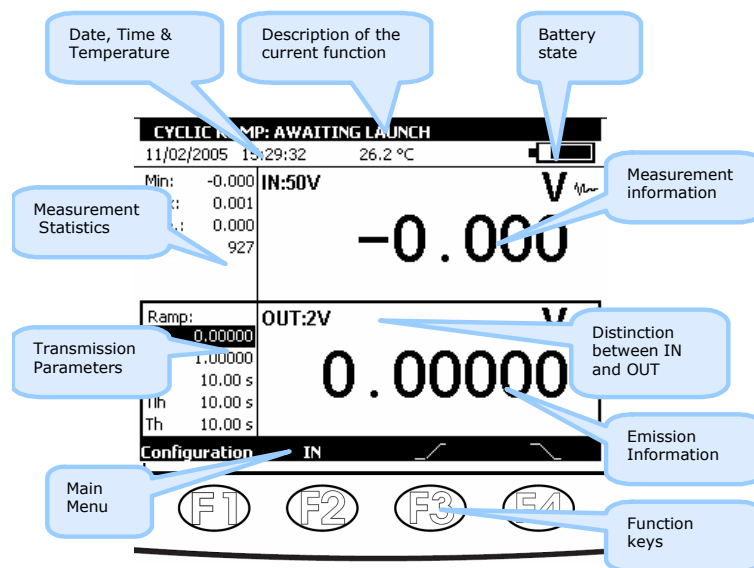
The basic items forming the user interface are shown in the diagram below:



The "on-line help" function is not visible in the menu, but is accessible at any time by pressing the  key. When active, a help window for the function in use appears. The  key closes the help window and all the dialogue boxes displayed.

The main menu is located at the bottom of the screen, opposite the four function keys (F1 to F4). To select an item from the menu, press the associated function key.

Navigation within menus and sub-menus is by means of the navigation keys and the ENTER key. For example, to display the% **FS** menu in the example of the screen below, perform the following steps:

- 1) Press the F4 key associated with the proposed **Mode** from the main menu.
- 2) Press the Down ∇ navigation key twice to select the **Predefined settings** sub-menu and confirm with the ENTER key.
- 3) Press the Down navigation key ∇ once to select the% **FS** sub-menu and confirm with the ENTER key. A dialogue box associated with this function appears and the four function keys change their function automatically to suit the dialogue box.

It is possible to cancel the selection at any time and return to the main menu by pressing the ESC key.

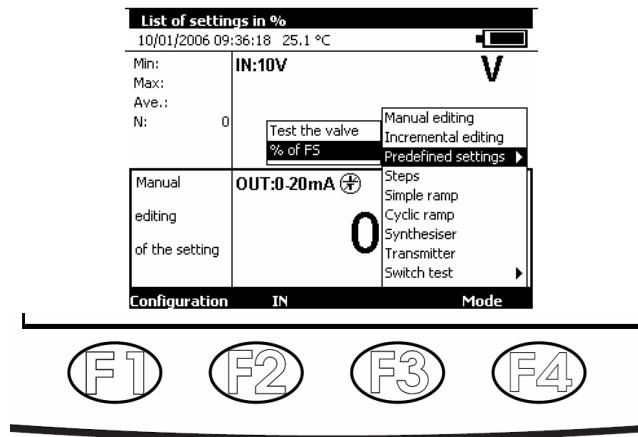

The dialogue box interface is intuitive. It is managed by the function and navigation keys.

The tabulation key **→** is used to select the next item from all the items in the dialogue box. For example, to select the “Type of scale” field on the following screen, press the **→** key once.

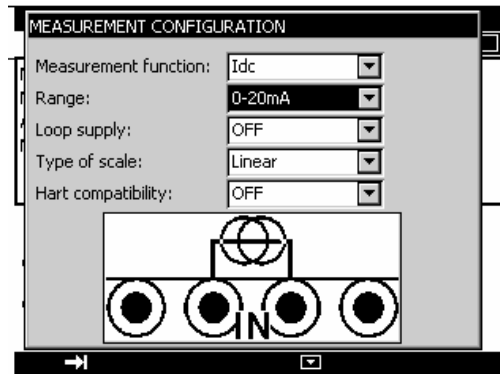

The tabulation key **→** functions cyclically, so that the first item follows the last.

The Right **▷** navigation key can replace the **→** tabulation key.

The **▾** function key is used to display a drop-down list. The **▾** key also closes an already open drop-down list. The Up **△** and Down **▽** navigation keys are used to select an item from an open list. Confirm is by pressing the ENTER key.

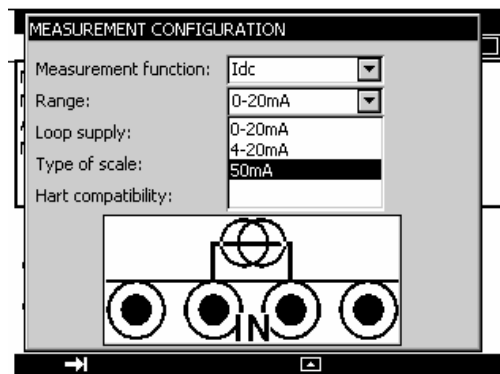



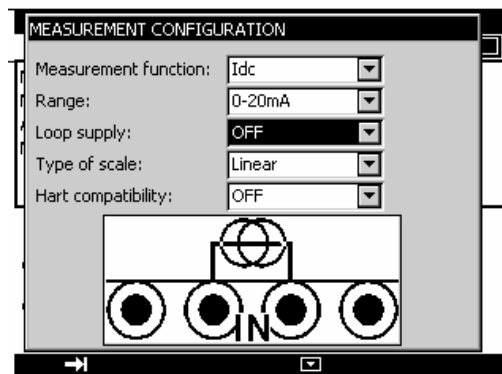



















There is a quicker way to select items from a drop-down list by using the Up/Down navigation keys to select the next/previous item from the list without displaying the contents of the list. For example, the state of the “Power supply loop” field can be changed from OFF to ON using the Down and Up navigation keys.



During operation of the MC 75, several symbols are displayed to simplify selection and indication of the current functions. These symbols are shown in the table below:

Symbol	Description
<i>Function keys</i>	
	Tabulation key
	Open a drop-down list
	Close a drop-down list
	Cancel the selected item
	Stop the current transmission
	Suspend the current transmission
	Commence or resume transmission
	Launch transmission in the increasing direction
	Launch transmission in the decreasing direction
	Transmit synthesised points in the order entered
	Transmit synthesised points in the reverse order
	Cancel the selection
	Add the item being edited
	Edit the selected item
	Open a file

Indication symbols	
	Maintain transmission or display of measurements
	Indication of battery state
	HART compatibility is on
	Loop power supply is on
	Loop power supply is off
	Square law scale is on
	Warning: Out of Range or error
	2 wire cabling detected
	3 wire cabling detected
	4 wire cabling detected
	Transmission in incremental mode
	Transmission in staircase mode
	Transmission in simple ramp mode
	Transmission in cyclic ramp mode
	Transmission in synthesiser mode
	Transmission in % of Full Scale mode (% FS)
	Transmission in valve test mode
	Item already selected
	Measurement smoothing is active
	The Tare function is on
	Setting to scale is on
	Pulse transmission
	Acquisition in progress (the value to the right of the pictogram indicates the number of values logged)

A.4 Safety

A.4.1 Compliance with safety standards

The unit is built and tested in accordance with European standard EN 61010-1: safety rules for electronic measuring equipment.

These user instructions contain information and warning notices which must be respected by the user for protection against danger from electric currents, ensuring correct operation of the unit and protection against any false step that could damage the unit or make it unsafe to use.

The unit may, when necessary, be subjected to temperatures of between -10 °C and +55 °C without prejudicing safety.

A.4.2 Instructions

The unit is designed to be used in complete safety if the instructions given in the accompanying documents are followed. Any use apart from those defined, may prejudice the safety of the operator and is therefore dangerous and forbidden.

A.4.3 Making measurements

Measuring wires and leads must be in good condition and must be replaced if their insulation appears defective (insulation cut, burned, etc.).

When the unit is connected to the measurement circuit, the terminals may be dangerous. Also, never place your hands near a terminal, whether in use or not. This advice also applies to the battery charger sockets and the USB link connected directly or indirectly to the terminals of the unit. Any work on these circuits must be carried out with the unit disconnected from any other external circuit.

Never exceed the limiting values of protection indicated in the specifications. Refer to chapter D.

When the order of magnitude of the value to be measured is unknown, make sure that the starting measurement range is the highest possible, or choose the automatic range selection mode.

Before changing the function, disconnect the wires for measuring the external circuit. When measuring current and/or voltage, even if low, remember that the circuits may be live with respect to earth, at a voltage that is dangerous for the operator.

Never carry out resistance measurements on a live circuit.

A.4.4 Unusual faults and stresses

Whenever it is believed that the protection has been damaged, switch off the unit and ensure that it is not used prematurely.

The protection may have been damaged if, for example:

- ✓ There is obvious damage to the unit.
- ✓ The unit is no longer able to make accurate measurements.
- ✓ The unit has been stored under unfavourable conditions.
- ✓ The unit has been subjected to severe stress during transportation.



A.4.5 Definitions

A.4.5.1 Definition of the installation category

This is also known as the overvoltage category.

It is the classification of the installation according to standard limits for transient overvoltages (standard CEI 664).

A.4.5.2 Table of symbols used

Symbol	Description
	Warning: see accompanying documents
	Earth point
	Complies with European Union directives

A.5 Service

The unit must always be set up according to the instructions in this notice. Incomplete or poorly executed setting up may adversely affect the safety of the operator.

The responsible authority must ensure on a regular basis that factors affecting safety do not change with time and carry out any necessary preventive work.

Before opening the unit for any work, you must ensure that all wires are disconnected from the unit

Any adjustment, maintenance or repair of an open unit must be avoided as far as possible and, if essential, must be carried out by qualified personnel who are familiar with the risks involved.

A.5.1 Recalibration/Maintenance

Not accessible to the user:

Consult SIKA who will indicate the procedure to follow for maintenance services.

A.5.2 Cleaning

If the MC 75 needs cleaning, use a tissue soaked in a non-solvent cleaning solution. Switch off the unit and wipe the sheath and keyboard if necessary. If any liquid enters the unit it may cause irreparable damage.

B. GETTING STARTED

In order to use the unit in complete safety, users must carefully read paragraph **A.4** which, among other things, deals with safety before handling. It is advisable also to read the following paragraphs:

- ✓ **Fehler! Verweisquelle konnte nicht gefunden werden. Fehler! Verweisquelle konnte nicht gefunden werden.**
- ✓ A.2.7 Batteries and charger
- ✓ A.5.2 Cleaning

B.1 Powering on

Connect the charger if this is the first time of use. The red LED  lights while the battery pack is charging. Wait until fully charged (LED off) before switching on the unit by pressing the Start/stop key

 for one second.

After starting, the MC 75 is set by default to voltage measurement and voltage transmission. Connect the Volts output to the Volts input as shown in the diagram below.

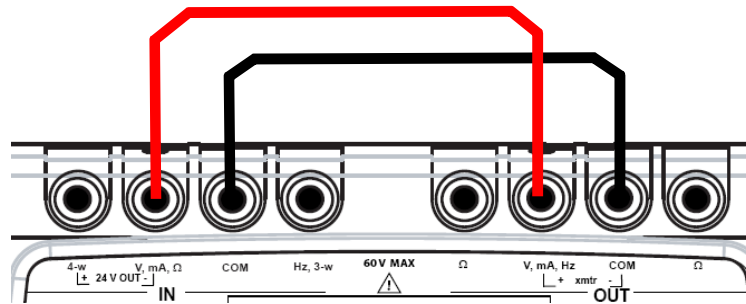

Check that the measurement displayed is the same as the simulated voltage.

To change the value of the simulated voltage, open the transmission window by pressing the OUT function key (F2). Enter a numerical value using the alpha-numeric keys and confirm with the ENTER key.

B.2 Measurement

For all measurement functions, open the measurement window with function key **F2** (IN). A rectangle surrounds the top window on the screen.

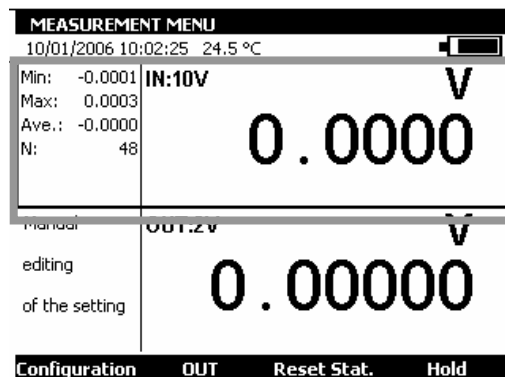

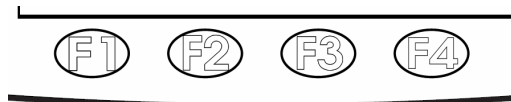

To choose a measurement function, press key **F1** (configuration).
 Select the **Function ...** menu with the navigation keys and confirm with the ENTER key.

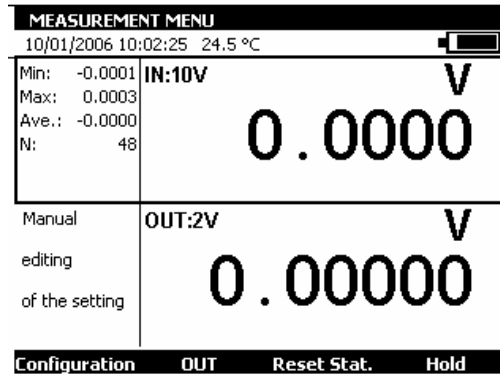

The **MEASUREMENT CONFIGURATION** dialogue box is displayed.

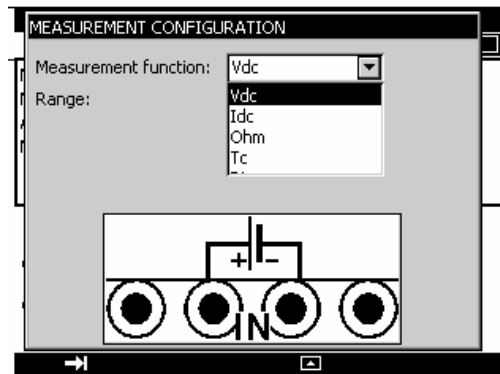

Connections in the measurement mode are made to the four “IN” terminals on the left half of the unit:

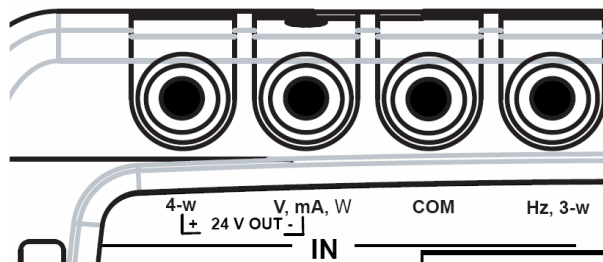

B.2.1 Voltage measuring (DC)

- Display the **MEASUREMENT CONFIGURATION** dialogue box:
- Select the **Vdc** measurement function then the correct measurement range using the function and navigation keys.
- Confirm with ENTER.

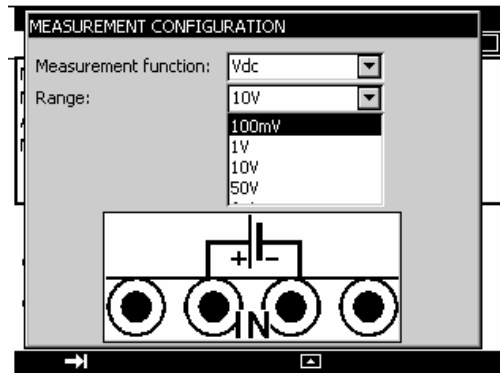

The following ranges are available:

Range	100 mV	1 V	10 V	50 V	Auto
Resolution	1 μ V	10 μ V	100 μ V	1 mV	---
Input impedance	> 10 k Ω	> 10 k Ω	1 M Ω	1 M Ω	---

The DC voltage to be measured is connected between the V and COM terminals.

B.2.2 Current measuring (DC)

- Display the **MEASUREMENT CONFIGURATION** dialogue box:
- Select the **Idc** measurement function then the correct range of measurement using the function and navigation keys.
- Confirm with ENTER.

Depending on the range selected, several modes of measurement are available:

Range	50 mA	4-20 mA	0-20 mA
Resolution	1 μ A	1 μ A	1 μ A
Input impedance	<30 Ω	<30 Ω <280 Ω if HART ON	<30 Ω <280 Ω if HART ON
Loop power supply	No	Possible	Possible
Set to scale	No	Linear or square law	Linear or square law

If loop power supply is on, the connection is made between terminals 4-w and mA.

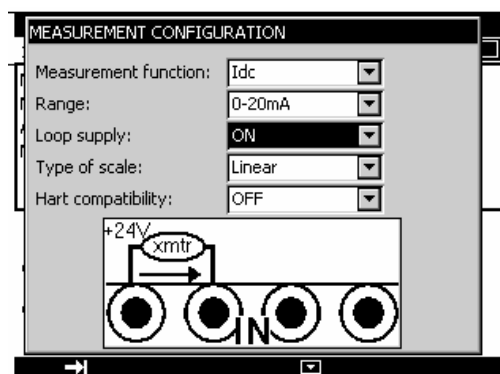

In this case, the MC 75 supplies a passive transmitter with 24 V and at the same time measures the current established by the transmitter.

If the loop power supply is off, the connection is made between terminals mA and COM.

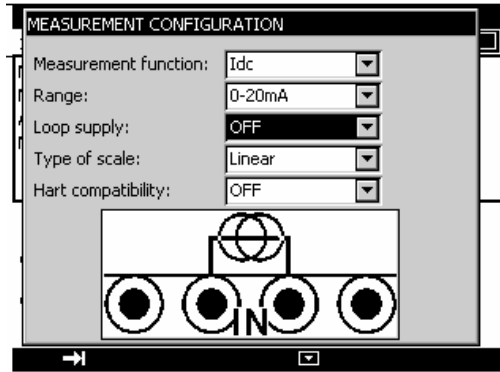

When set to the square law scale, the calibrator takes the square root of the input and displays the result as a percentage. For example, if the calibrator is connected to the output of a differential pressure transmitter, it displays a result proportional to the flow rate.

If the input current x varies between a and b , the scale is set according to the formula:

$$y = a + (b - a) \sqrt{\frac{(x - a)}{(b - a)}}$$



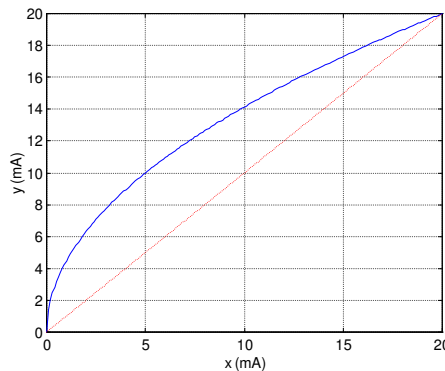

In the case of the 0-20 mA range, the scale curve is as follows:

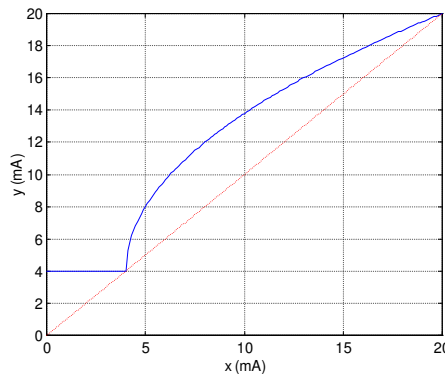

In the case of the 4-20 mA range, the scale curve is as follows:



The MC 75 displays in the window details of the selected configuration using the following icons:

-  : to show loop power supply off
-  : to show loop power supply on
-  : to show square law scale
-  : to show HART compatibility.

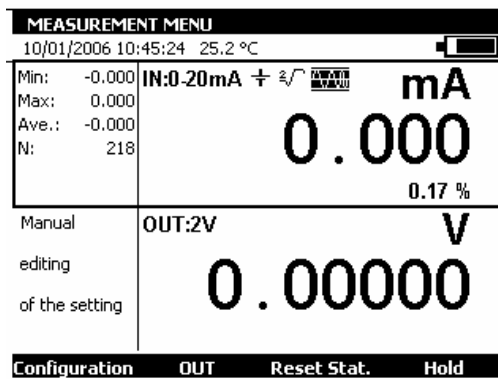

When the values measured are near the lower limit of the range (0 mA or 4 mA) a small variation in the values measured translates into a more significant variation for the converted values (in %) because of the square law nature of the scaling.

B.2.3 Resistance measuring

- Display the **MEASUREMENT CONFIGURATION** dialogue box:
- Select the **Idc** measurement function then the correct measurement range using the function and navigation keys.
- Confirm with ENTER.

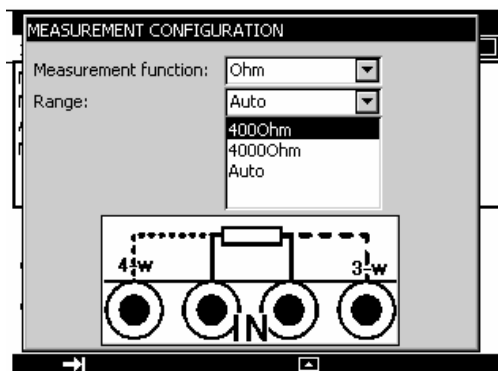

The following ranges are available:

Range	400 Ω	4000 Ω	Auto
Resolution	1 m Ω	10 m Ω	--
Measurement current	0.25 mA	0.25 mA	0.25 mA

To carry out a correct resistance measurement with 3 wires, the 3 conductors used must be:

- ✓ of the same length,
- ✓ of the same diameter,
- ✓ of the same type of metal.

The MC 75 displays an icon showing the connections used (⎓ for 2 wire, ⎓ for 3 wire or ⎓ for 4 wire) to make the measurement. The wiring arrangement is automatically detected by the calibrator.

B.2.4 Continuity test

- Display the **MEASUREMENT CONFIGURATION** dialogue box:
- Select the **Continuity** measurement function using the function and navigation keys.
- Confirm with ENTER.

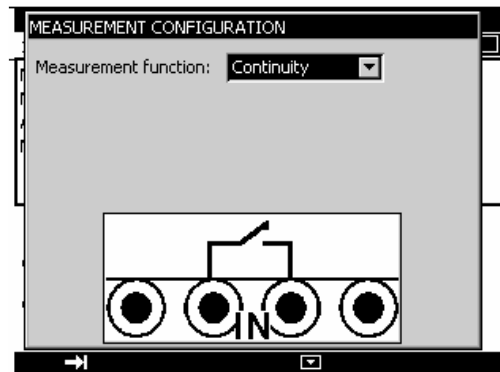

The MC 75 makes a resistance measurement in this mode and displays “open” if the resistance measured is greater than 1000 Ohm and “closed” if the resistance measured is less than 1000 Ohm.

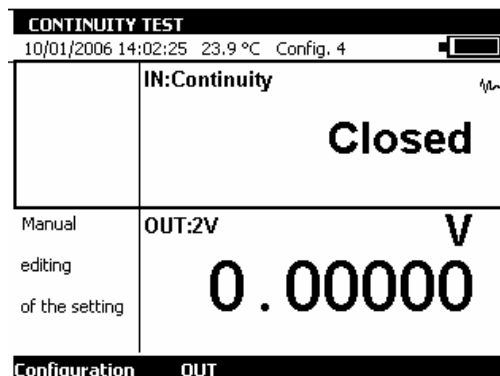

B.2.5 Frequency measuring (signal)

- Display the **MEASUREMENT CONFIGURATION** dialogue box:
- Select the **Frequency** measurement function, then the “type of input” **Signal** using the function and navigation keys.
- Confirm with ENTER.

Connection is made between the Hz and COM terminals.

The display unit may be in Hz or in beats per minute (BPM).

The measurement resolution is 0.01 Hz.

The input voltage of periodic signals must not exceed 60 Volts peak to peak.

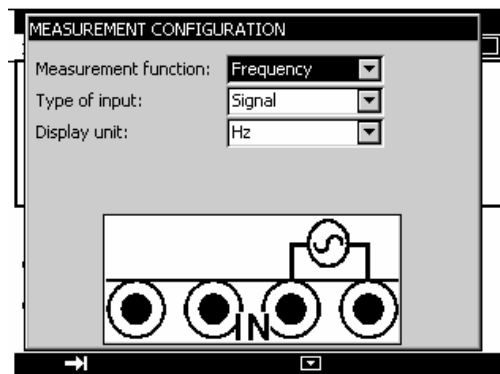

A square wave signal is generated from the input signal by comparing the amplitude of the input signal with 1 Volt. The result of the comparison is input to a microprocessor which measures the frequency by counting with respect to a very stable reference signal.

B.2.6 Frequency measuring (dry contact)

- Display the **MEASUREMENT CONFIGURATION** dialogue box:
- Select the **Frequency** measurement function, then the “type of input” **Dry Contact** using the function and navigation keys.
- Confirm with ENTER.

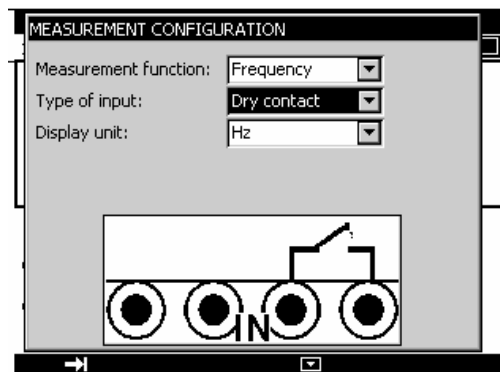

Connection is made between the Hz and COM terminals.

The hard contact frequency measurement is displayed as a frequency measurement by generating a logic signal of level 0 when the contact is closed and level 1 when the contact is open.

The display unit can be in Hz or in Beats Per Minute (BPM).

B.2.7 Pulse counting

- Display the **MEASUREMENT CONFIGURATION** dialogue box:
- Select the **Counting** measurement function, then the “type of input” **Signal or Hard Contact** using the function and navigation keys.
- Enter the counting time using the alphanumeric keys.
- Confirm with ENTER.

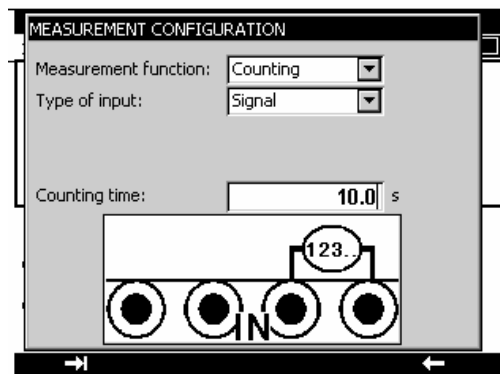

Connection is made between the Hz and COM terminals.
 The input signals are converted into a logic signal as in the case of signal frequency or hard contact measurement.
 If you enter a zero counting time, the counting lasts indefinitely.

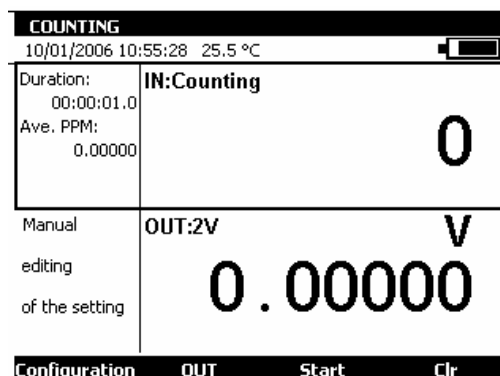

To initiate counting, confirm with the **Start** function key (“F3”).
 To stop counting without resetting the counter value, confirm with the **Stop** key.
 To reset the counter to zero, press the **Clr** key (F4)
 The counting period is displayed in the left part of the IN window. This period is reset whenever counting is stopped.

B.2.8 Temperature measuring (RTD)

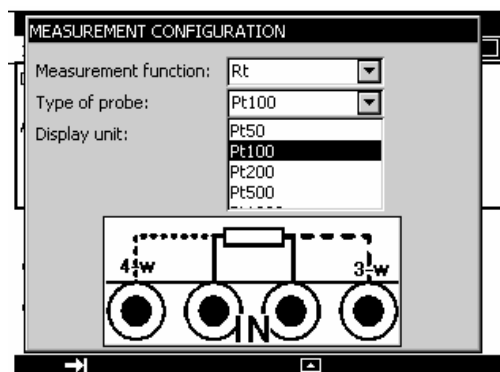

- Display the **MEASUREMENT CONFIGURATION** dialogue box:
- Select the **Rt** measurement function, then the appropriate “type of probe” using the function and navigation keys.
- Select the display unit
- Confirm with ENTER.



Connection is made according to the number of wires of the resistive probe.
 The following probes are available:

Sensor
Pt 50 ($\alpha = 3851$)
Pt 100 ($\alpha = 3851$)
JPt 100 ($\alpha = 3916$)
Pt 100 ($\alpha = 3926$)
Pt 200 ($\alpha = 3851$)
Pt 500 ($\alpha = 3851$)
Pt 1 000 ($\alpha = 3851$)
Ni 100 ($\alpha = 618$)
Ni 120 ($\alpha = 672$)
Ni 1 000 ($\alpha = 618$)
Cu 10 ($\alpha = 427$)
Cu 50 ($\alpha = 428$)

α Being the temperature coefficient of the probe.

The MC 75 displays an icon showing the connections used ( for 2 wires,  for 3 wires or  for 4 wires) to carry out the measurement. The wiring arrangement is automatically detected by the calibrator.

In order not to introduce an error when measuring with 3 wires, the following is recommended:

- Measure using conductors of the same length, the same diameter and the same type of metal (a difference of 40 mΩ between two wires introduces an error of about 0.1 °C).
- Take care with the connections to avoid the appearance of interfering contact potential differences.

B.2.9 Temperature measuring (Thermocouple)

- Display the **MEASUREMENT CONFIGURATION** dialogue box:
- Select the **Tc** measurement function, then the appropriate “type of thermocouple” using the function and navigation keys.
- Select the display unit
- Select the type of cold junction (CSF) used. Enter the temperature of the cold junction in the case of a programmed cold junction.
- Confirm with ENTER.

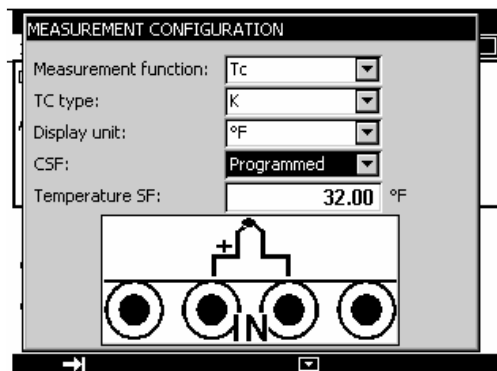

The thermocouples available are: K, T, J, E, N, U, L, S, R, B, C, PL, Mo, NiMo/NiCo.

After a significant thermal shock, it is recommended that the unit is left for the temperature to stabilise in order to use the internal cold junction (CSF) with maximum accuracy.

B.2.10 Pressure measuring

- open the **MEASUREMENT CONFIGURATION** dialog box,

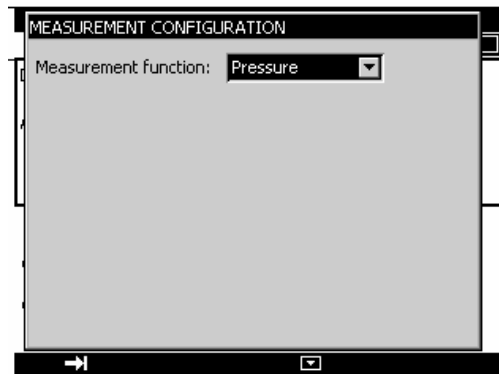

- select the **Pressure** measurement function.
- press ENTER.

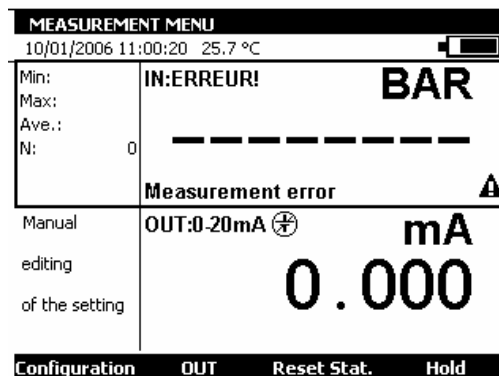

Connect the pressure sensor on the right-hand side of the unit (see chapter, side connectors). If this is not connected or is defective, an error message will be displayed.

B.2.11 Pressure switch test

The MC 75 can detect the opening or closing of a contact (switch) and acquire the value of pressure at the moment that this change of state occurs.

In this case, the pressure measurement function is configured from the transmission part. The transmission/simulation functions are selected by pressing the function button, **F2** (OUT). Pressing this button activates the transmission/simulation window (see next chapter for more information on the transmission/simulation part).

- open the **MEASUREMENT CONFIGURATION** dialog box,
- select the **Pressure** measurement function.
- press ENTER.

To access the **Switch Test** mode, press the function button, **F4**, to select the **Mode** menu and then press ENTER.

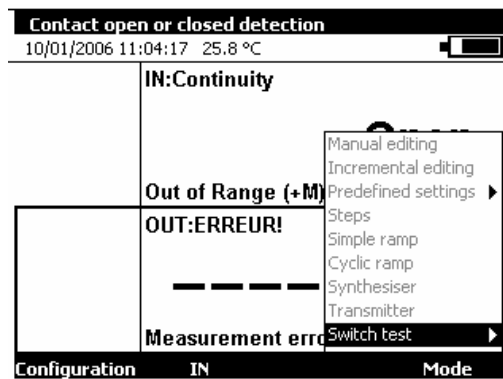

- Select the type of detection (**Open, Close or Open and Close**) and press ENTER.

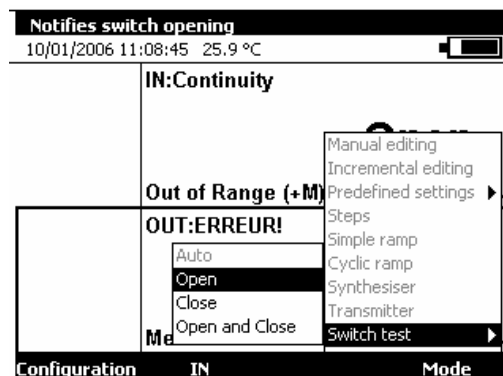

Once the type of detection is selected, every change of the selected type is detected and the measured value of pressure at the time of change is displayed.

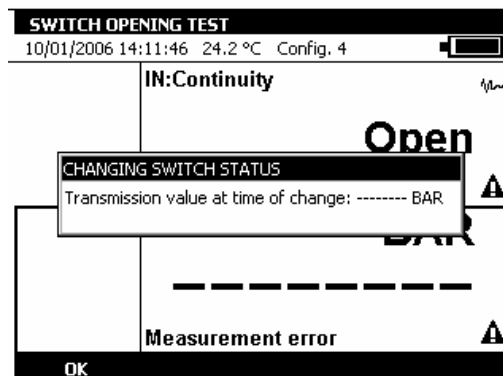

- To accept (acknowledge) the measurement, press the function button, **F1 (OK)**.
- To exit the **Switch Test** mode, press **ESC**.

B.3 Generation/Simulation

The transmission/simulation functions are selected by pressing the function button, **F2** (OUT). Pressing this button activates the transmission/simulation window: the lower window in the display is then marked by a rectangular border.

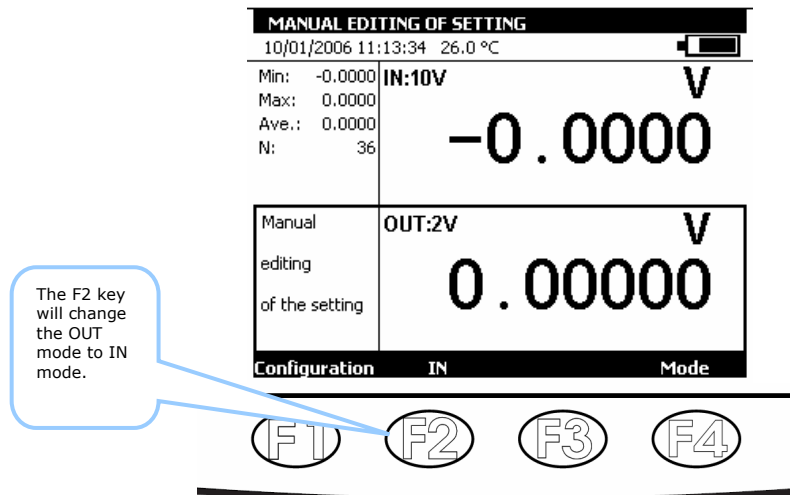

To select a Simulation function, press the **F1** (configuration) key. Select the **Function ...** menu using the navigation keys and confirm with the ENTER key. A **TRANSMISSION CONFIGURATION** dialogue box is displayed. The connections in the Transmission mode are made to the four “OUT” terminals located on the right half of the unit:

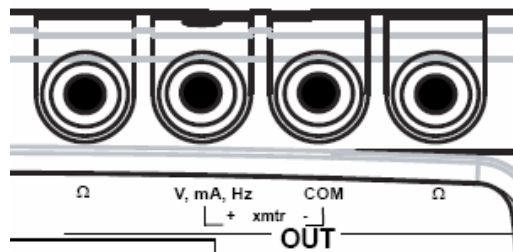

B.3.1 Voltage generation (DC)

- Display the **TRANSMISSION CONFIGURATION** dialogue box:
- Select the **Vdc** transmission function, then the range suitable for measurement using the function and navigation keys.
- Confirm with ENTER.

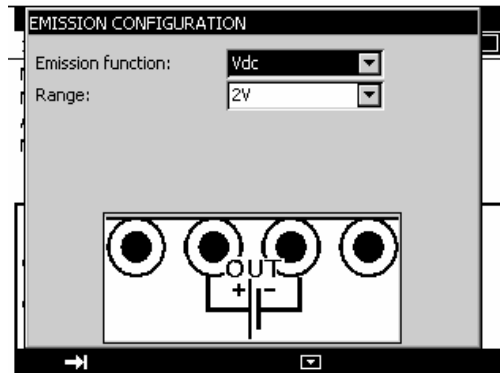

The following ranges are available:

Range	100 mV	2 V	20 V
Resolution	1 μ V	10 μ V	100 μ V
Output impedance	< 1 Ω	<1 Ω	<1 Ω
Output load	1 K Ω	2 K Ω	4 K Ω

The DC source voltage to be generated is connected between terminals V and COM.

B.3.2 Current generation (DC)

- Display the **TRANSMISSION CONFIGURATION** dialogue box:
- Select the **Idc** measurement function, then the range using the function and navigation keys.
- Confirm with ENTER.

Depending on the range selected, several transmission modes are available:

Range	24 mA	4-20 mA	0-20 mA
Resolution	1 μ A	1 μ A	1 μ A
Loop power supply	No	Possible	Possible
Set to scale	No	Linear or square law	Linear or square law

Connection is made between the mA and COM terminals.

If the loop power supply is on, the MC 75 simulates a passive transmitter supplied with 24 V internally.

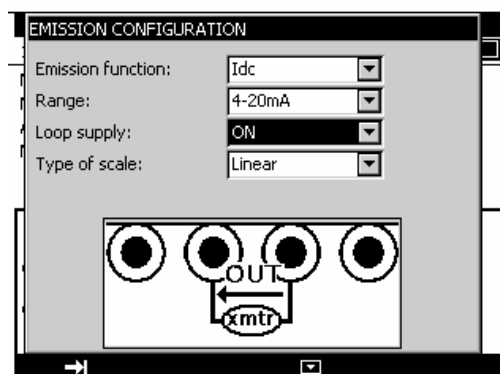

If the loop power supply is off, the MC 75 simulates a passive transmitter supplied with 24 V externally.

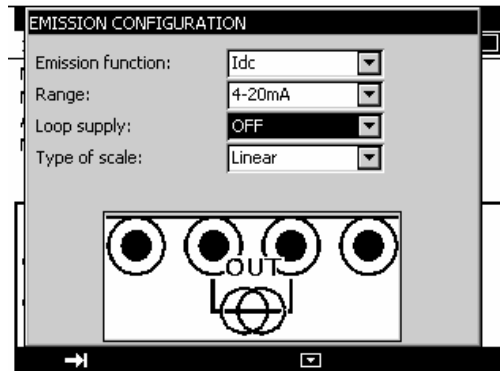

When the square law scale is selected, it must be activated by using the **Configuration → Set to scale** menus. Once “set to scale” is activated, the user enters the values to be simulated in a unit of the new scale.

The MC 75 indicates the configuration selected in the window, using the following icons:

- ⊖ : to show Loop power is off
- ⊕ : to show Loop power is on
- √ : to indicate a square law scale

Refer to paragraph B.2.2 (Current measuring (DC)) for an explanation of the square law scale.

B.3.3 Resistance generation

- Display the **TRANSMISSION CONFIGURATION** dialogue box:
- Select the **Ohm** measurement function, Select the **Idc** measurement function, then the range using the function and navigation keys.
- Select the measurement current
- Confirm with ENTER.

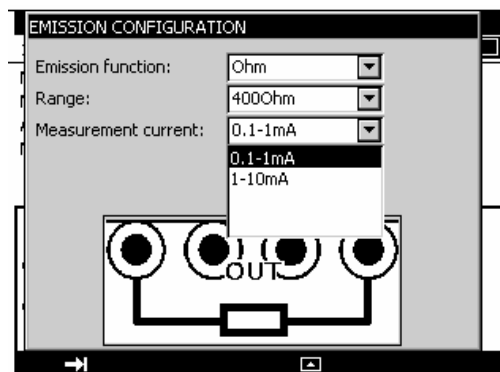

The following ranges are available:

Range	40 Ω	400 Ω	4000 Ω
Resolution	1 m Ω	1 m Ω	10 m Ω
Measurement current	1-10 mA	0.1-1 mA or 1-10 mA	0.1-1 mA
Settling time	< 1 ms	< 1 ms	< 1 ms

If the measurement current is very high, the message “Out of Range” is displayed in the transmission window.

The resistance simulation function can be used with either 2, 3 or 4 wire connection.

If a polling acquisition system is used, ensure that the current is maintained for more than 1 ms to avoid measurement errors due to the response time of the resistance simulation function.

B.3.4 Temperature simulation (RTD)

- Display the **TRANSMISSION CONFIGURATION** dialogue box:
- Select the **Rt** transmission function, then the appropriate “type of probe”, and range using the function and navigation keys.
- Select the measurement current
- Select the display unit
- Confirm with ENTER.

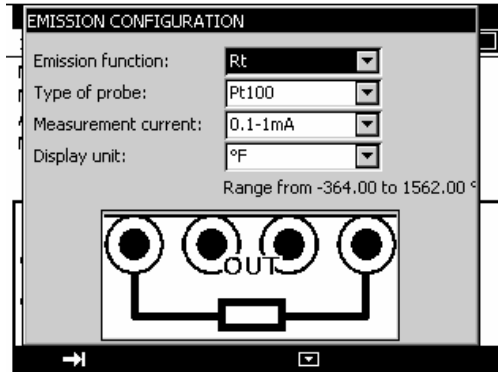

Connection is made between the two terminals.
 The following probes are available:

Sensor
Pt 50 ($\alpha = 3851$)
Pt 100 ($\alpha = 3851$)
JPt 100 ($\alpha = 3916$)
Pt 100 ($\alpha = 3926$)
Pt 200 ($\alpha = 3851$)
Pt 500 ($\alpha = 3851$)
Pt 1 000 ($\alpha = 3851$)
Ni 100 ($\alpha = 618$)
Ni 120 ($\alpha = 672$)
Ni 1 000 ($\alpha = 618$)
Cu 10 ($\alpha = 427$)
Cu 50 ($\alpha = 428$)

The resistive temperature probe simulation function can be used with either 2, 3 or 4 wire connection.

As for the resistance simulation function, if a polling acquisition system is used, ensure that the transmitter carries out the measurement at least 1 ms after the current is present.

B.3.5 Temperature simulation (Thermocouple)

- Display the **TRANSMISSION CONFIGURATION** dialogue box:
- Select the **Tc** transmission function, then the appropriate “type of thermocouple”, using the function and navigation keys.
- Select the display unit
- Select the type of cold junction compensation (CSF) used. Enter the temperature of the CSF in the case of a programmed CSF.
- Confirm with ENTER.

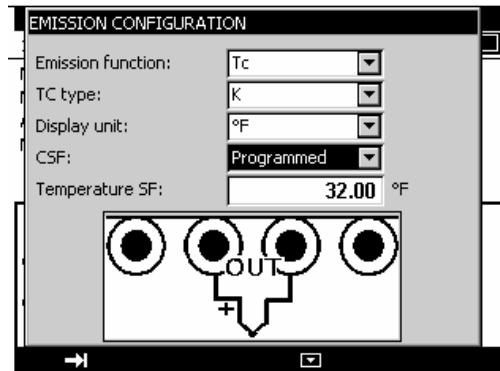

The thermocouples available are: K, T, J, E, N, U, L, S, R, B, C, PL, Mo, NiMo/NiCo.

After a significant thermal shock, it is recommended that the unit is left for the temperature to stabilise in order to use the internal cold junction (CSF) with maximum accuracy.

B.3.6 Frequency generation (signal)

- Display the **TRANSMISSION CONFIGURATION** dialogue box:
- Select the **Frequency** transmission function, then the range using the function and navigation keys.
- Select the **Signal** "Output type".
- Enter the amplitude of the signal between 0 and 20 V.
- Confirm with ENTER.

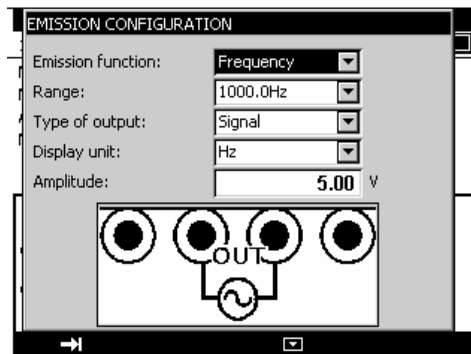

The following ranges are available:

Range	1,000 Hz	10,000 Hz
Resolution	0.01 Hz (1)	1 Hz (1)
Max. Amplitude	20 V	20 V

(1) Note that the captured value may differ from the displayed value. The frequency generated is derived from a fixed frequency by dividing it by a whole number. The displayed value (within the resolution of the display) is, therefore, this value recalculated with the fastest approximation to the captured value.

The display units may be in Hz or Beats per minute (BPM).

Connection of the frequency source generated is between the Hz and COM terminals.

B.3.7 Frequency generation (dry contact)

- Display the **TRANSMISSION CONFIGURATION** dialogue box:
- Select the **Frequency** transmission function, then the range using the function and navigation keys.
- Select the “Type of Output” **Hard contact**.
- Confirm with ENTER.

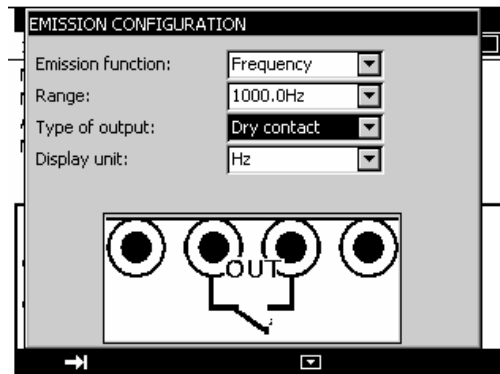

The following ranges are available:

Range	1,000 Hz	10,000 Hz
Resolution	0.01 Hz (1)	1 Hz (1)
Max. Amplitude	20 V	20 V

(1) Note that the captured value may differ from the displayed value. The frequency generated is derived from a fixed frequency by dividing it by a whole number. The displayed value (within the resolution of the display) is, therefore, this value recalculated with the fastest approximation to the captured value.

The display units may be in Hz or Beats per minute (BPM).

Connection of the frequency source generated is between the Hz and COM terminals.

B.3.8 Pulse generation

- Display the **TRANSMISSION CONFIGURATION** dialogue box:
- Select the **Pulse** transmission function, then the range using the function and navigation keys.
- Select the “Type of Output” **Signal**.
- Enter the amplitude of the signal between 0 and 20 V.
- Confirm with ENTER.

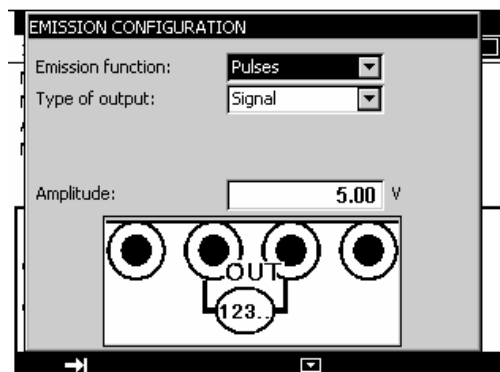

The  icon appears in the Transmission window.

To change the default parameters, press ENTER or enter the **Configuration ...** menu then **Pulses ...**

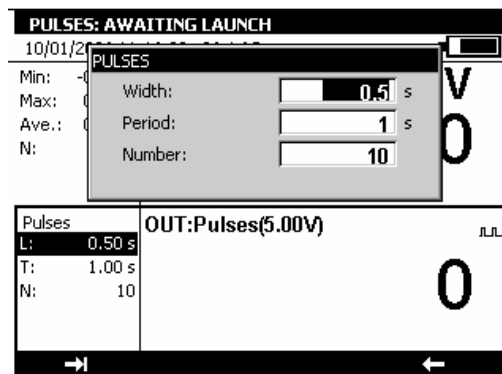

The parameters are:

- Width: the duration of the HIGH logic state in seconds
- Period: the duration of the HIGH logic state and the LOW logic state in seconds
- Number: the number of pulses to be generated, between 1 and 999,999.

To commence pulse generation, press **Start**.

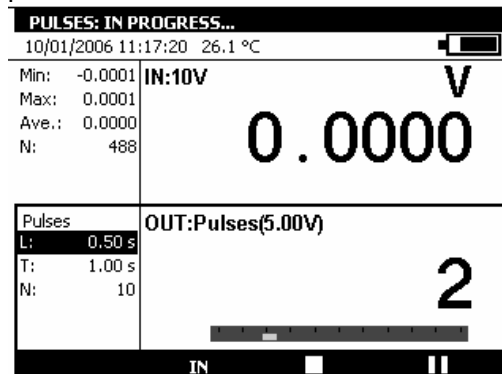

During pulse generation, a progress bar indicates the state of progress. The function keys can be used to control generation:

The  key stops generation at any time

The  key suspends generation

The  key commences or resumes generation

The  icon in the transmission window indicates suspended generation.

C. ADVANCED OPERATION

C.1 Simulation Modes

Several transmission modes are available in the MC 75 to facilitate rapid checking and calibration of instruments and transmitters.

To change the transmission mode, open the transmission window using the **OUT** function key (F2).

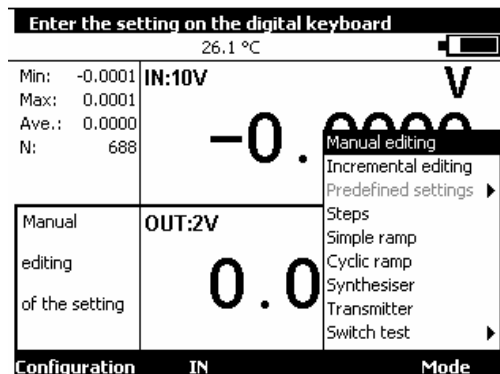

When the transmission window is open, the MC 75 is set by default to the **Manual edit** mode.

To access the other modes, select the **Mode** menu using function key F4. Select a transmission mode using the Up/Down keys of the navigator and confirm with ENTER.

To exit a transmission mode and return to the default mode, press the ESC key.

C.1.1 Manual Editing

In this mode, the value to be transmitted may be entered directly using the alphanumeric keys.

The value entered appears at the bottom of the transmission window during entry.

To cancel the entry, press the ESC key. To transmit the value entered, confirm with the ENTER key.

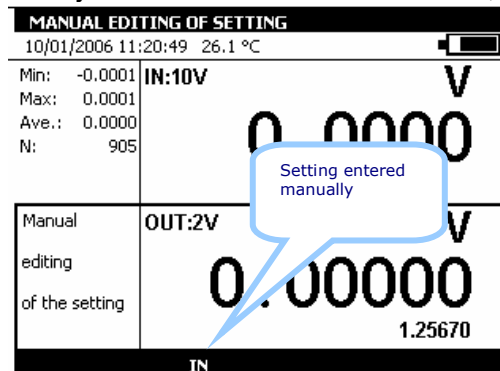

C.1.2 Incremental Editing

When this mode is active, the **+** icon appears in the transmission window.

Use the 4 navigator keys to edit the value to be transmitted.

To select a digit, use the Left **<** and Right **>** keys of the navigator. The editable digit appears reversed in the display (white on black).

To increment/decrement the digit selected, use the Up **△** or Down **▽** key of the navigator.

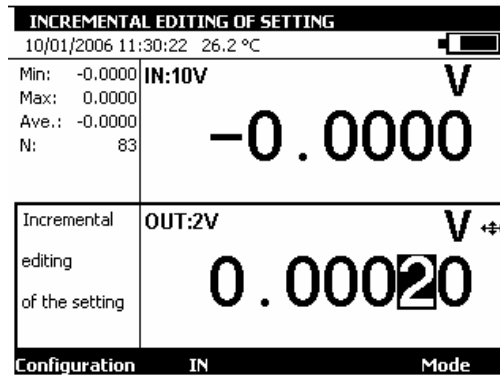



The value displayed is immediately active and it is not necessary to confirm it.

C.1.3 Predefined Settings

This mode is available for the DC current transmission function for the 0-20 mA and 4-20 mA ranges only.

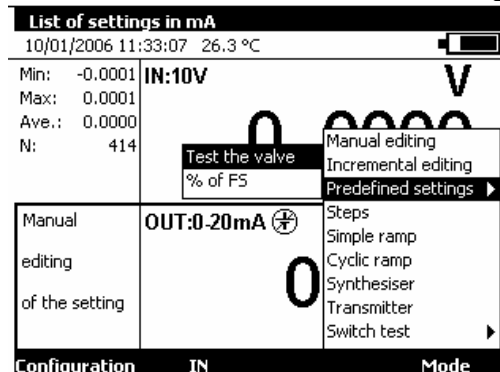
Two types of predefined settings are offered: Valve Test and Percentage of full scale (% of FS).



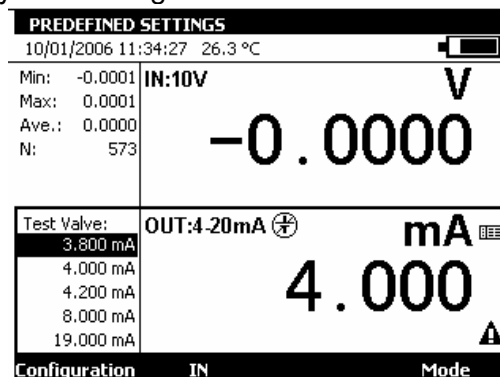

In the case of valve test, the predefined values are displayed in the left hand side of the transmission window. The  icon is displayed in the right hand side of the window.

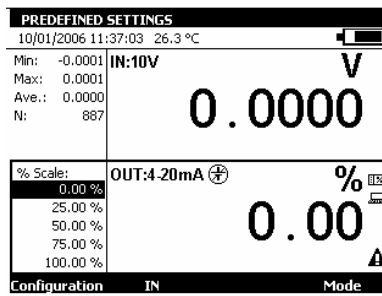

The Up/Down keys of the navigator can be used to select the setting from the list. The ENTER key transmits the selected setting. The Left/Right keys of the navigator are used to transmit the previous/next setting. The numerical keys 0 - 9 are used to enter the value to be transmitted on the keyboard.

In the case of values predefined as a percentage of full scale, the  icon appears on the left hand side of the transmission window.



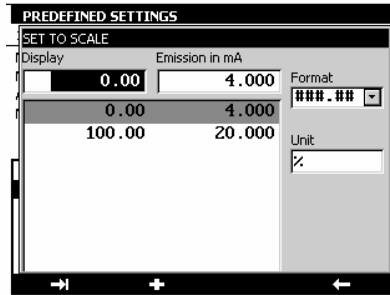

The  icon indicates setting to scale. To display the scale applied, use the Configuration menu, then the “set to scale” menu.

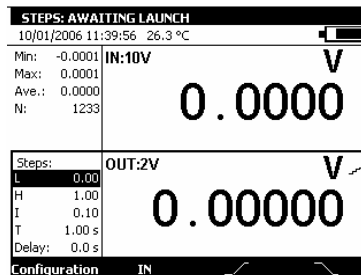

C.1.4 Steps

This mode is used to program an incremental progression of the active transmission function. When this mode is active, the  icon appears in the transmission window.



The  function key launches a cycle of increasing increments and the  function key launches a cycle of decreasing increments. The default parameters of this mode are displayed on the left hand side of the transmission window. To change these parameters, press ENTER or use the **Configuration → Mode...** menus.

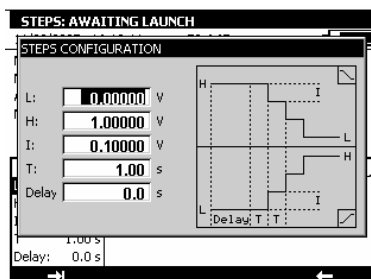

The parameters of a staircase are:
 B: minimum amplitude of the signal.
 H: maximum amplitude of the signal.
 I: amplitude of the increment
 T: duration of the steps in seconds
 Delay: delay in seconds between launching the staircase and transmission of the first increment.

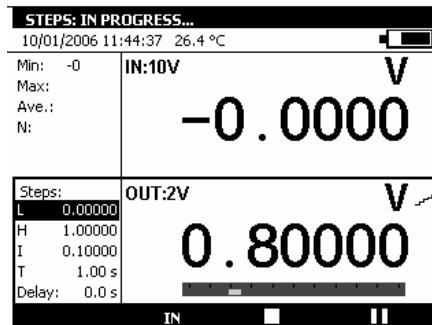

During generation of a staircase, a progress bar indicates the state of progress. The function keys control generation:

The  key stops generation at any time

The  key suspends generation

The  key commences or resumes generation

An  icon in the transmission window indicates suspended generation.

C.1.5 Simple Ramp

The simple ramp generation function is used to program a linear variation in one direction (increasing or decreasing) of the active transmission function.

When this mode is active, the  icon appears on the transmission window.

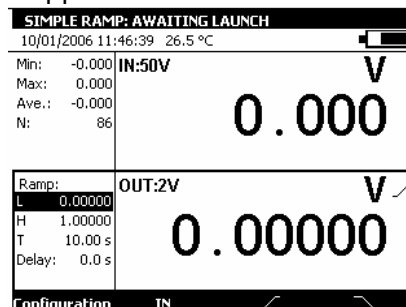

The  key is used to launch an increasing ramp and the  function key is used to launch a decreasing ramp.

The default parameters of this mode are displayed in the left hand side of the transmission window. To change these parameters, press ENTER or use the **Configuration** → **Mode...** menu.

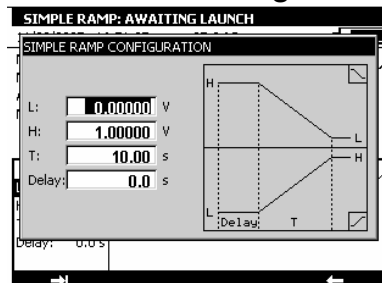

The parameters of a simple ramp are:

B: minimum amplitude of the signal.

H: maximum amplitude of the signal.

T: duration of the ramp in seconds.

Delay: delay in seconds between launching the ramp and the start of transmission.

During generation of a simple ramp, a progress bar indicates the state of progress. The function keys are used to control generation:

The  key stops generation at any time

The  key suspends generation

The  key commences or resumes generation



An  icon in the transmission window indicates suspended generation.

C.1.6 Cyclic Ramp

The cyclic ramp generation function is used to program a first linear variation in a direction (increasing or decreasing) followed by a first step and then a second linear variation in a direction opposite to the first variation followed by a second step.

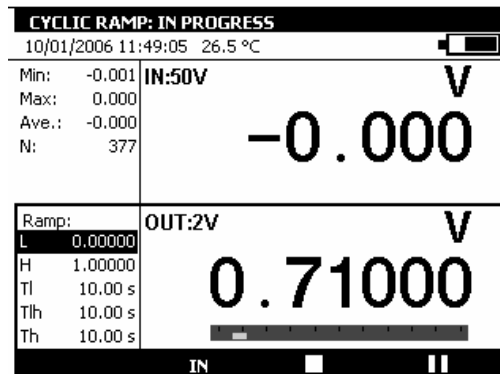
When this mode is active, the  icon appears in the transmission window.



The  function key is used to launch an increasing cyclic ramp and the  function key is used to launch an decreasing cyclic ramp.

The default parameters of this mode are displayed in the left hand side of the transmission window. To change these parameters, press ENTER or use the **Configuration → Mode...** menu.

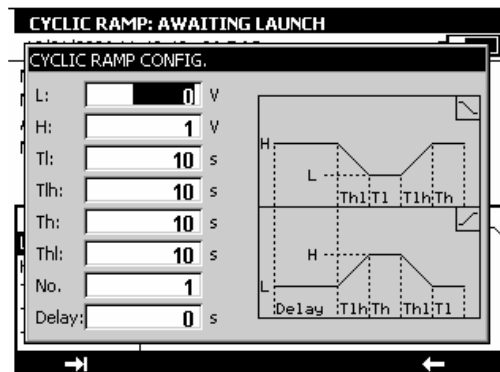

The parameters of a cyclic ramp are:

B: minimum amplitude of the signal.

H: maximum amplitude of the signal.





Thb: duration of a decreasing ramp.

Tbh: duration of an increasing ramp.

Th: duration of the high step.

Tb: duration of the low step.
 Nbr: number of cycles to be generated.
 Delay: delay in seconds between launch of the cyclic ramp and the start of transmission.

During generation of a cyclic ramp, a progress bar indicates the state of progress. The function keys are used to control generation:

- The  key stops generation at any time
- The  key suspends generation
- The  key commences or resumes generation
- An  icon in the transmission window indicates suspended generation.



C.1.7 Synthesiser

The synthesiser function is used:

- to store up to 100 transmission values in permanent memory,
- to recall and transmit the contents of these memories manually or automatically.

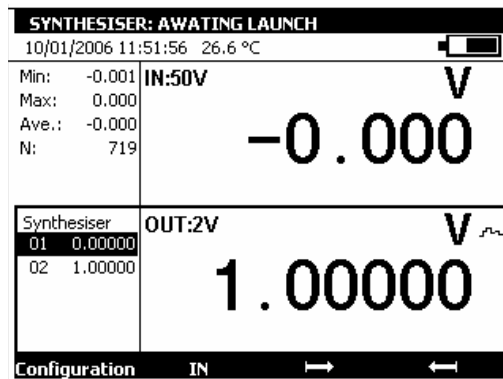
When this mode is active the  icon appears in the transmission window.



The  key is used to launch generation of values in increasing order and the  function key is used to launch generation of values in decreasing order.

The default parameters of this mode are displayed in the left hand side of the transmission window.

The parameters of the synthesiser mode are:

First point no.: number of the first point in a cycle

Last point no.: number of the last point in a cycle

T: the duration for which a point is transmitted.

Nbr: the number of polling cycles

Delay: delay between launch and transmission of the first point.

To change these parameters, use the **Configuration** → **Synthesiser...** → **Parameters...** Menu.

The number of the first point may be higher than that of the last point. All points between the first and last are generated.

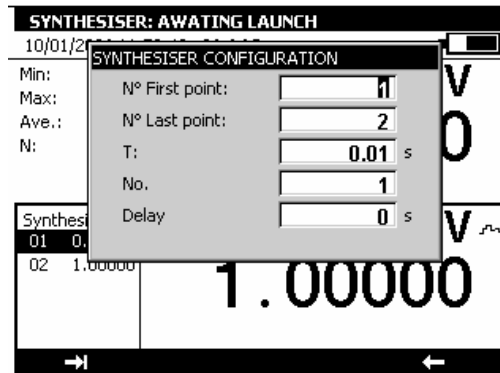

To edit the points to be synthesized, use the **Configuration** → **Synthesiser...** → **Points....** Menus.

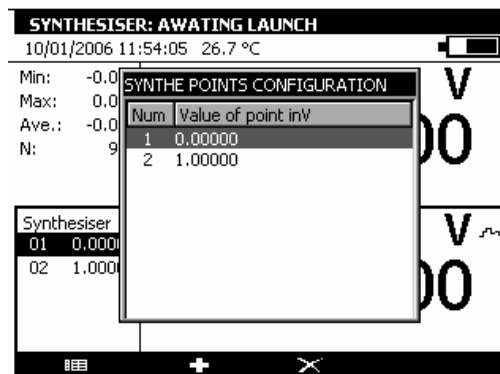

Use the function keys:

- to cancel a point
- to add a point
- to edit a point

use the and keys to transmit points according to the parameters defined.

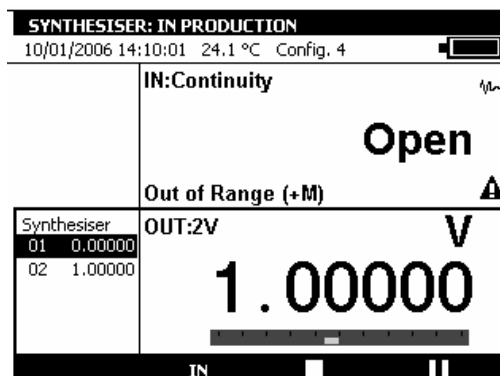

During generation, a progress bar indicates the state of progress. The function keys are used to control generation:

- The key stops generation at any time
- The key suspends generation
- The key commences or resumes generation
- An icon in the transmission window indicates suspended generation.

It is possible to transmit points manually one by one using the navigation keys. Use the Up and Down keys to select a point. ENTER transmits the selected point and Left/Right select and transmit the previous/next point in the list immediately.

C.1.8 Transmitter Mode

This mode is used to transmit a value identical to the measured value.

C.2 Scaling

The scale correction function performs a conversion between the electrical quantities measured and the physical quantities converted.

This linearisation is used partially to correct errors induced by non linear sensor/converter systems.

The Set to scale function is used to define up to 10 segments of a straight line, or 10 points, in order to approach a non linear response curve as closely as possible and to perform scale corrections for each segment.

The  symbol is displayed on the screen in the active window when Set to scale is active.

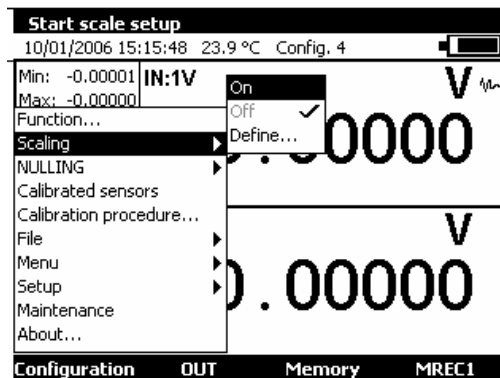

The **Define...** menu is used to program up to

10 lines of 2 values: X and Y= f(X).

In measurement:

X = The value measured

Y = The value displayed.

In transmission:

X = The Setting displayed

Y = The value transmitted.

The lines entered are sorted according to increasing X to set to scale a value X, the unit searches for the 2 lines n and m=n+1 that enclose it and extrapolates linearly:

$$Y = Y_n + (X - X_n) \times (Y_m - Y_n) / (X_m - X_n)$$

Use the function keys to edit the points:

To Add a line: enter X and Y, then press the  function key.

To select a line from the list, use the Up and Down navigation keys.

To cancel a selected line, use the  key.

The Format and Units zones are used to select the number of decimal places and the display units.

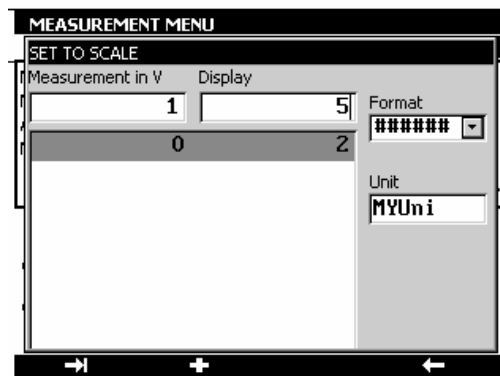

C.3 NULL/Tare/Offset

The relative measurement function of the unit is used:

- ✓ to program a reference value other than that of the unit (ZERO function),
- ✓ to cancel by measurement or programming a constant or interfering value (TARE function).

When one of the relative measurement functions is active, the Δ symbol is displayed on the screen in the measurement window.

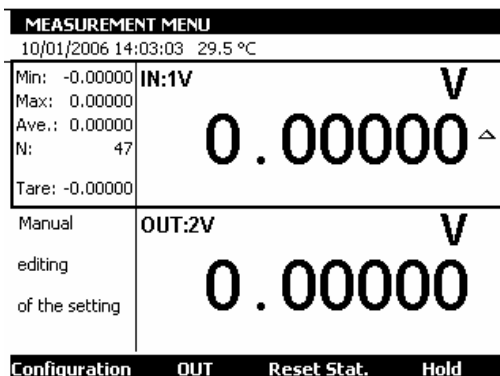
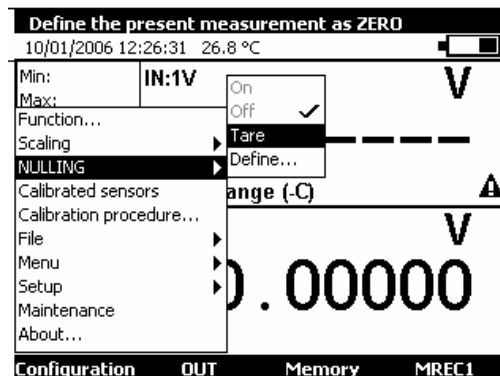

The **ZERO** → **Define...** menu is used to program the Tare value (positive or negative). This value is subtracted from the measurements:

$$\text{Value Displayed} = \text{Value measured} - \text{Tare Value}$$

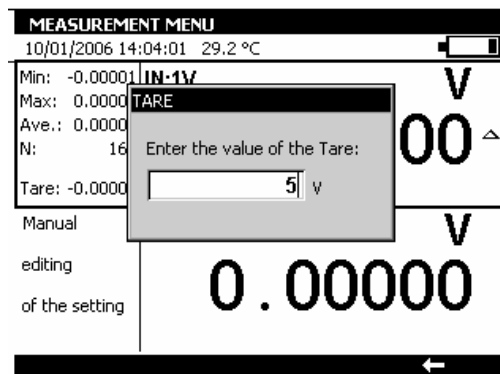

C.4 Calibrated sensors

The unit's calibrated sensors function makes it possible to use sensors of which the calibration (correction) factors can be taken into account by the unit at the time of measurement.

- Open the **MEASUREMENT CONFIGURATION** dialog box,
- select the **Calibrated Sensors** function.

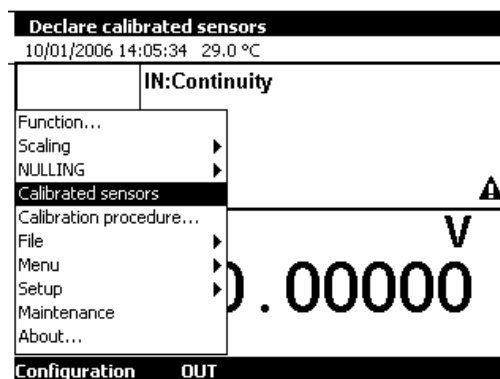

- press ENTER.

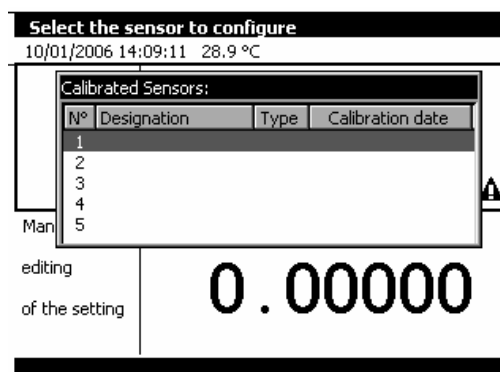

- Use the Up Δ / Down ∇ arrow buttons to adjust the parameters or select a new line to define a new sensor.
- press ENTER.

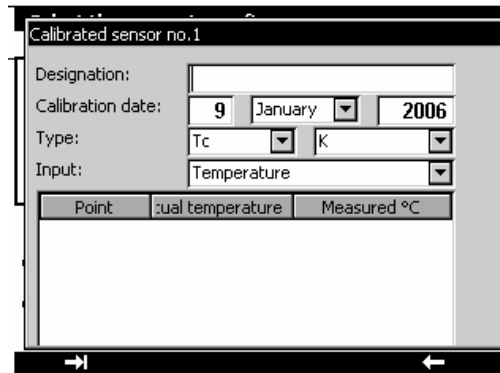

- Fill in the information fields for the sensor. To move from field to field, use the function button, **F1** (→|).

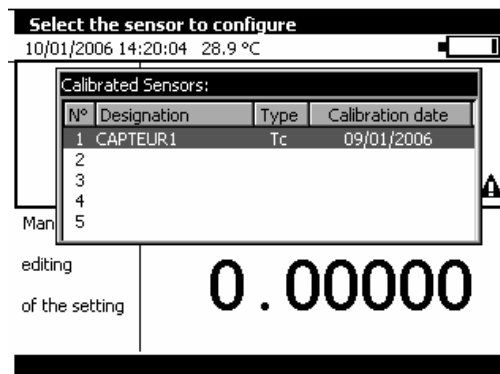

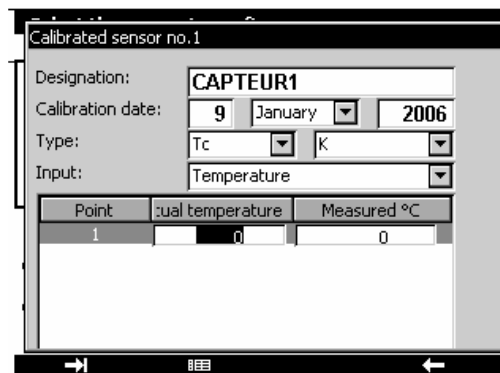

- To enter calibration points in the table, use the **+** button.

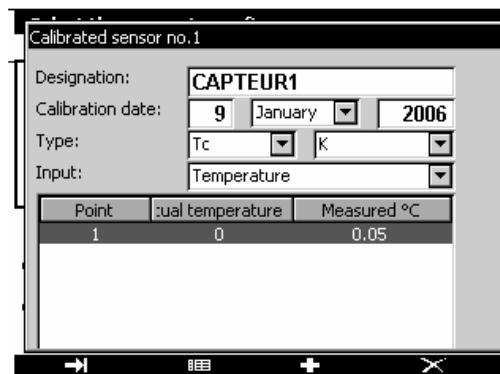

- Enter the values and press ENTER.



- Use the following buttons to continue configuring a sensor.

-  to edit an existing calibration point,
-  to add a calibration point,
-  to delete a calibration point.

Between 1 and 4 calibration points can be entered per sensor. These calibration points are used to calculate a polynomial $c(T)$ of degree 0 to 3, giving the sensor's voltage (or resistance) correction at temperature T.

In the specific case where a single calibration point is given, the behavior will differ according to whether the sensor is a thermocouple or a thermometric resistance:

- . In the case of a thermocouple, the correction is a fixed voltage deviation.
- . In the case of a resistive probe, the correction made is an R0 correction.

Sensors declared in this manner are added to the list of couple types (or of probe types) proposed in the measurement function settings dialog box. They appear at the top of the list, in front of the standard sensors. Their name is preceded by the '*' character, indicating that these are calibrated sensors.

C.5 Calibration procedure

The MC 75 is capable of creating a calibration report from a pre-defined procedure. The number of procedures that can be recorded depends on the size of the available memory and the size of each procedure (number of test points). If the memory is not being used by other functions, it is possible to record several tens of procedures.

To find the available memory size, refer to the chapter, Storage of current acquisitions (chapter 6).

- Open the **MEASUREMENT CONFIGURATION** dialog box,
- select the **Calibration procedure** function,
- press ENTER.



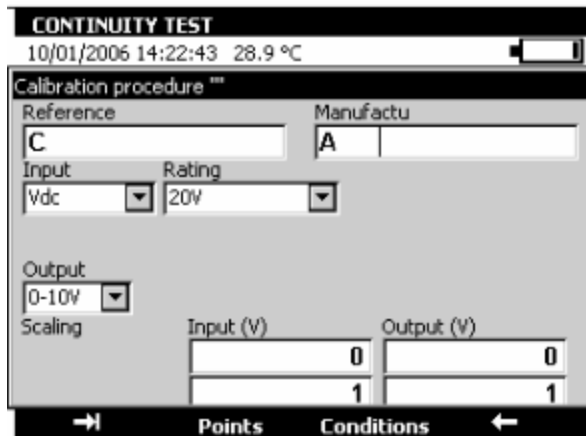

- Use the Up ∇ / Down \triangle arrow buttons to adjust the parameters or press the function button **F1** (new) to define a new procedure,
- press ENTER.

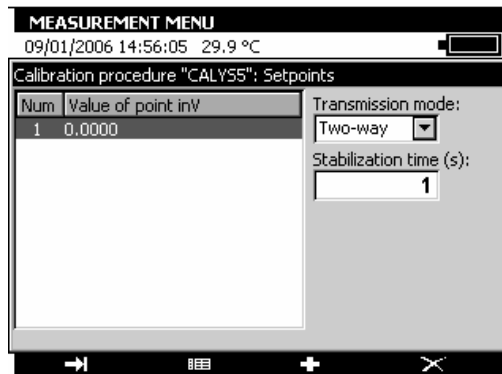

- Complete the information fields for the transmitter to be calibrated and define the input/output types and the full-scale, where appropriate. To move from field to field, use the function button, F1 (→).
- Define the calibration points by pressing F2 (Points).



- Use the following buttons to define the points.

-  to edit an existing calibration point,
-  to add a calibration point,
-  to delete a calibration point.

- Use the F1 (→) button to select the transmission mode field, press the function button, F4 (☑) to drop down the menu and use the Up Δ / Down ∇ arrow buttons to choose the transmission mode.

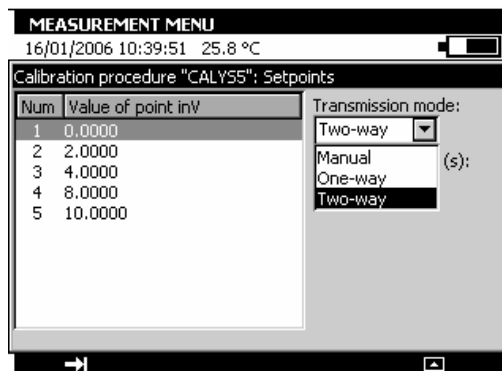

Definitions of transmission modes:

Manual: the settings are generated under manual control with the user accepting each point,

One-Way: the settings are generated automatically in the order in which the points (Point 1, Point 2, Point3 etc.) are defined,

Two-Way: the settings are generated automatically in the order in which the points (Point 1, Point 2, Point3 etc.) are defined and then in reverse order (Point n, Point (n-1) etc.).

The settling time field can be used to define the time, in seconds, between sending the setting from the output of the MC 75 and making the measurement at its input.

- When all fields have been completed, press ENTER.

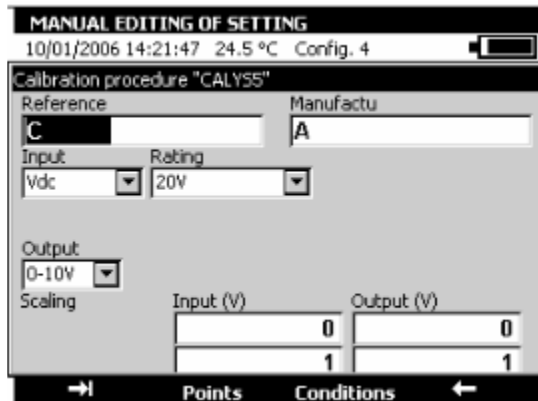

- Press **F3** (conditions) to define the test conditions (limits).

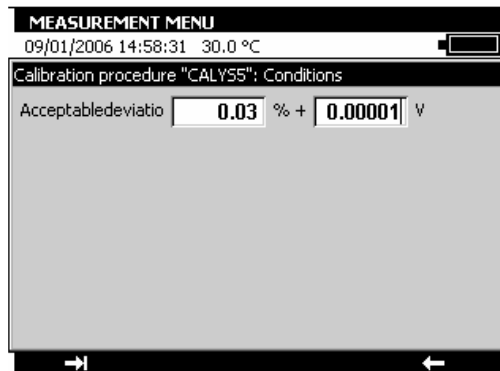

- When the limits have been defined, press ENTER.
- Press ENTER again.

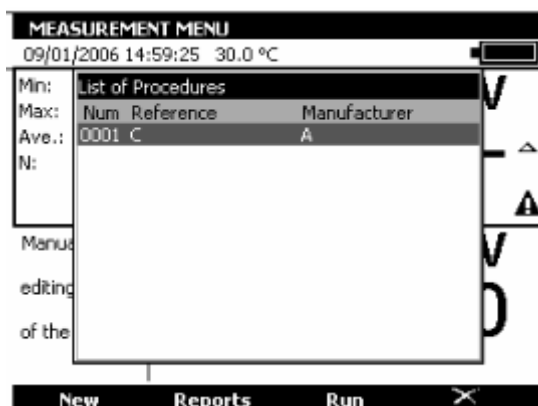

- To execute the procedure, press **F3** (Execute).



- After completing the fields, start execution by pressing **F3** (Execute).

Where the procedure is executed manually, the user will have to confirm the calibration points one by one.

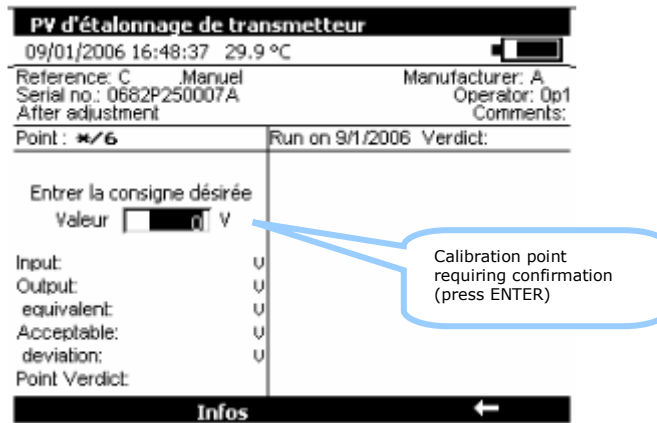

If the transmission mode has been defined as One-Way or Two-Way, the procedure is executed automatically.

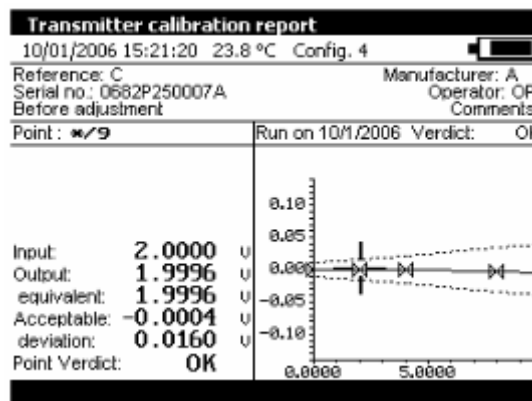

- Press the function button, **F1**, to store the calibration report.

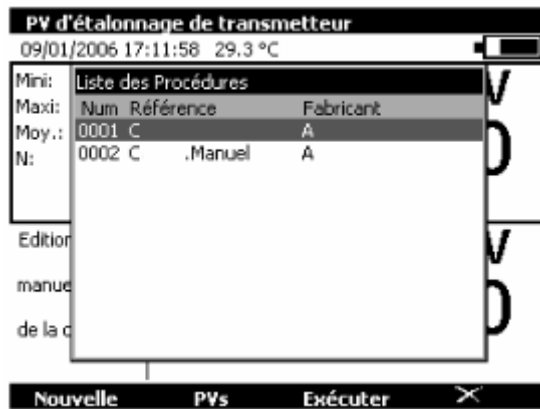

- To display the calibration reports, select the desired procedure and press the function button, **F2** (Reports).
- From the list, select the report to be viewed and press the function button, **F1** (View).

C.6 Memory functions

The MC 75 is capable of storing 10,000 values in one or more acquisition bursts.

- If necessary, use the **F2** button to open the 'IN' window and display the **Measurement** menu bar.
- Open the Configuration menu by pressing **F1**.
- Select the **Menu** function then **Memory**.
- Press **ENTER**.

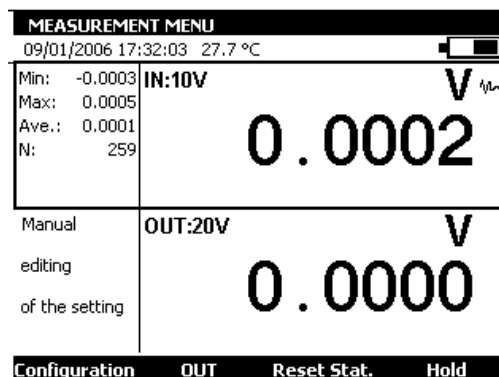

Two new functions, Memory and MREC1, then appear in the bottom bar (replacing the functions Rest stat. And Hold). The left \triangleleft and right \triangleright arrow buttons can be used to switch from one mode to the other.

Pressing the function button, **F4** (MREC1), stores the current acquisition.

Pressing **F3** (Memory) gives access to all the memory functions.

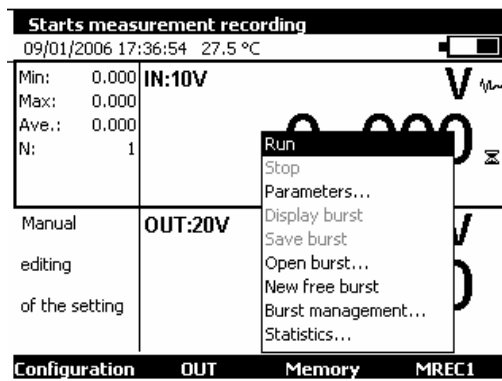

RUN:

starts the storage of data as configured using the **Parameters** function. The icon is shown in the Measurements window.

STOP:

stops the current storage operation.

PARAMETERS

This can be used to define:
 the burst size (10,000 values max.),
 the sampling period, from 0.5 sec. to 30 min,
 and the type of trigger (none, low level, high level).

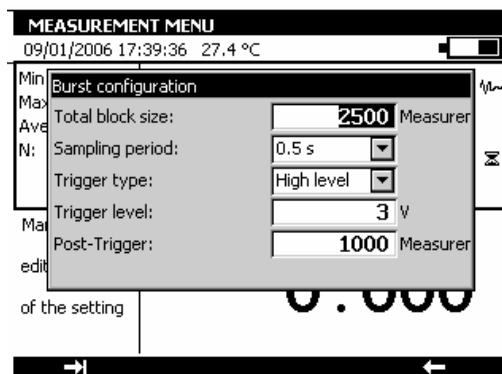

If high-level or low-level trigger is selected, the trigger level and number of data points to be stored after this trigger must be defined.

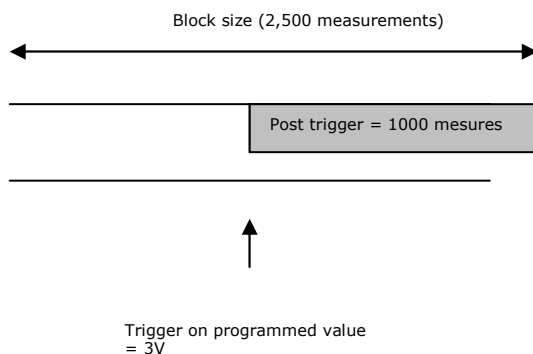

Burst display:

The burst can be displayed as a table of values or a trend curve.

N°	Time	Value	Unit
1	00:00:00.0	9.5377	V
2	00:00:00.5	9.4959	V
3	00:00:01.0	9.4540	V
4	00:00:01.5	9.4123	V
5	00:00:02.0	9.3565	V
6	00:00:02.5	9.3293	V
7	00:00:03.0	9.2878	V
8	00:00:03.5	9.2463	V
9	00:00:04.0	9.2047	V
10	00:00:04.5	9.1631	V

At this level, markers can be set (F1 and F2 function keys) and all values falling between these 2 markers can be displayed in graphical form.

To display all the values in memory, press the function button, **F1** (Global).

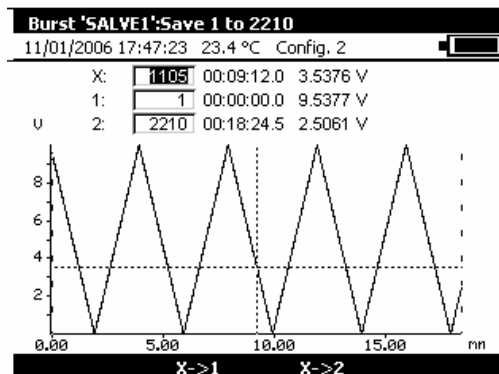

The left ◀ and right ▶ arrow buttons can be pressed to move the cursor and read off the abscissa and ordinate values.

At this level, the markers can be redefined in order to zoom in between these two new points:

- in the X field, enter a low value for the marker (X1), press ENTER and then press the function button, F2 (X→1),
- in the X field, enter a high value for the marker (X2), press ENTER and then press the function button, F3 (X→2).

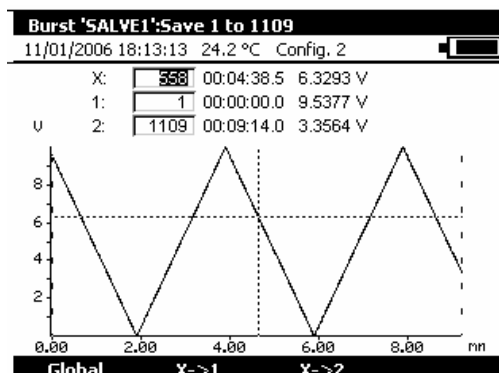

Burst save:

stores the current burst.

Burst open:

allows a burst to be selected for opening in order to view the data. At this level, a burst can be renamed or one or more bursts can be deleted.



New burst:

starts a new burst. If a burst is running, the user will be asked if this should be saved.

Burst management:

can be used to view all bursts in memory. At this level, a burst can be renamed or one or more bursts can be deleted.

Statistics:

shows the number of bursts in memory, the number of free bytes and the number of measurements that can be saved.

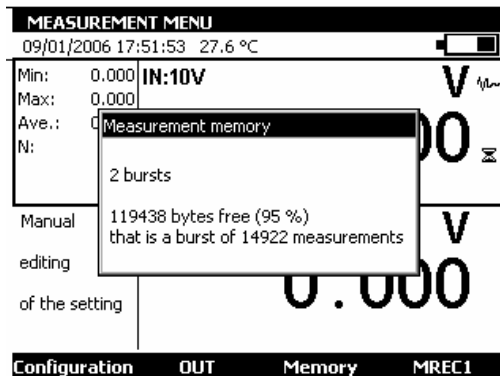

C.7 Customer specific configurations

A configuration is the state of the MC 75 at a given moment. The state of the unit includes:

- The current functions and ranges for measurement and simulation,
- The parameters of all the transmission modes (staircase, ramp, synthesiser, etc.),
- The scale corrections applied,
- All the preferences defined in paragraph C.8.3.

To save the state of the unit, use the **Configuration → File → Record under...** menus.

Use the navigation keys to select a configuration. Edit the name of the configuration to be saved with the alphanumeric keys and confirm with ENTER.

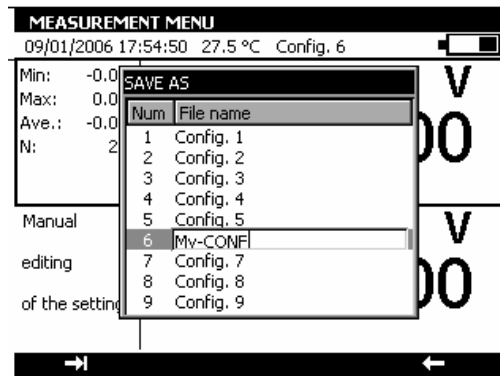

To recall a configuration from memory, use the **Configuration** → **File** → **Open...** menus.

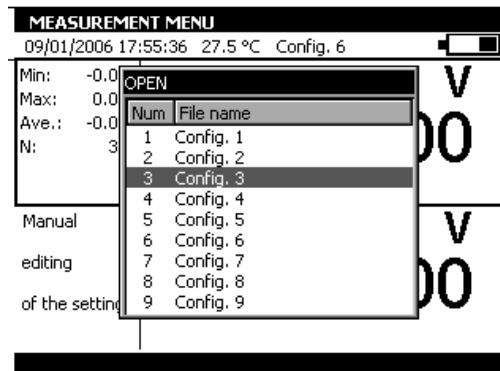

Use the navigation keys to select a configuration. Confirm with ENTER. When loading a saved configuration, the MC 75 enters the manual Edit mode in transmission.

To erase the configurations of the MC 75, go to the Maintenance mode. (Password 9456). Use the **Init EEP** function key to reset the configurations of the unit to zero.

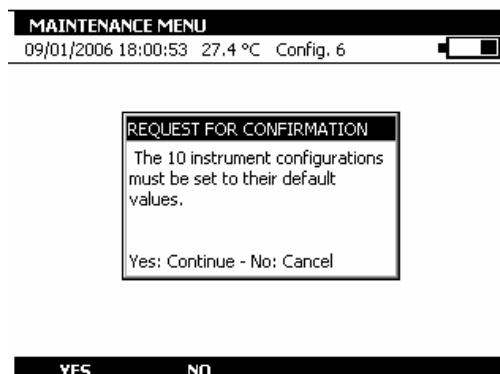

C.8 Instrument Setup

The parameters of the MC 75 can be set using the **Configuration** → **Setup** menus.

The **Contrast...** sub menu is used to adjust the contrast of the display.

The **Date/Time...** sub menu is used to set the date and time of the unit.

The **Preferences...** sub menu is used to set the generic parameters which apply to all the functions performed by the MC 75.

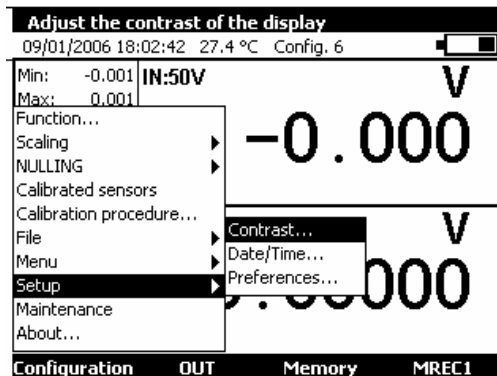

C.8.1 Contrast

Use the Right and Left navigation keys to adjust the contrast of the display. The MC 75 saves the setting made in its non volatile memory and uses it each time the unit is switched on.

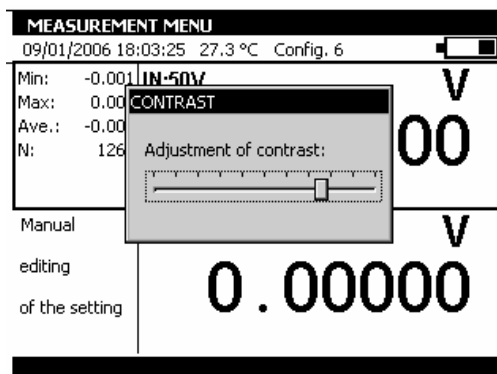

C.8.2 Date and Time

To set the date and time, use the **Configuration** → **Setup** → **Date/Time...** menus.

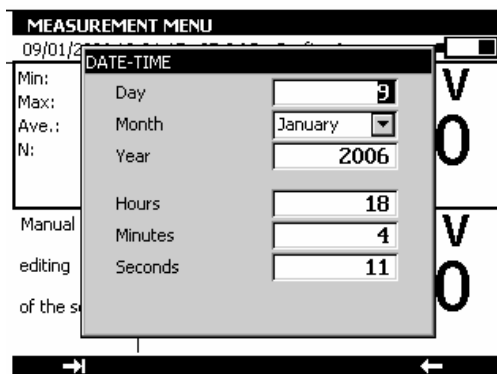

C.8.3 Preferences

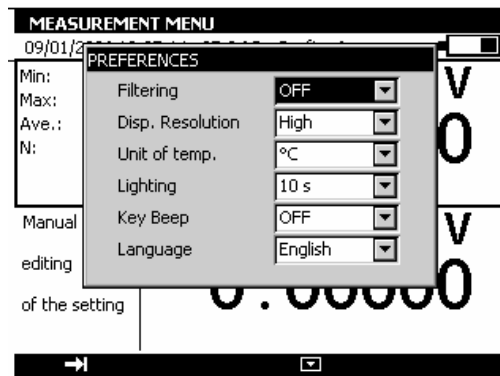

To display the Preferences dialogue box, use the **Configuration → Setup → Preferences...** menu.

The adjustable parameters are:

Filtering: Used to average measurements before display. When filtering is switched off, the integration time for measurements is 0.5 seconds.

Resolution: Used to adjust the resolution of the measurements when displayed. There are three possible choices:

- **HIGH**: displays measurements with the highest possible resolution.
- **AVERAGE**: displays one digit fewer compared with the HIGH resolution mode.
- **LOW**: displays two digits fewer compared with the HIGH resolution mode.

Temperature units: used to select the temperature units, either °C, °F or K, for measurements and simulation.

Lighting: used to set the on time of the lighting before it is switched off to save the batteries.

Beep keys: used to switch on or off the transmission of an audible signal when pressing keys on the keyboard.

Language: used to select the language of the display in menus, dialogue boxes and on-line help.

D. TECHNICAL SPECIFICATIONS

The accuracies quoted apply at + 18°C to + 28°C unless otherwise stated, and are expressed as $\pm (n \% L + C)$ where L = The reading and C = a Constant expressed in practical units. The specifications are given for a confidence level of 95%.

They apply to a product placed under reference conditions of measurement defined hereafter:

- A preheating of twenty minutes is necessary.
- Use of the product without battery charger (wait thirty minutes after the end of the load).
- For weak signals (measurement and simulation: voltage cal 100mV and Ohm) use connections with bare wires or spade terminals.

The accuracy includes the accuracy of the reference standards, non linearity, hysteresis, repeatability and long term stability over the period quoted.

D.1 Measurement Function

Measurement rate: 0.5 s per measurement.

Maximum rated voltage in common mode: 60 VDC or VAC.

D.1.1 Voltage measurement (DC)

Range	Resolution	Accuracy	Notes
±100 mV	1 µV	0.013 % of rdg. + 3 µV	Rin > 10 M Ω
±1V	10 µV	0.013 % of rdg. + 20 µV	Rin > 10 M Ω
±10V	100 µV	0.015 % of rdg. + 200 µV	Rin = 1 M Ω
±50V	1 mV	0.015 % of rdg. + 2 mV	Rin = 1 M Ω

Temperature coefficient <7 ppm/°C from 0 °C to 18 °C and from 28°C to 50 °C.
Use the absolute value of the value measured (|L|) to calculate the accuracy.

D.1.2 Current measurement (DC)

Range	Resolution	Accuracy	Notes
±50 mA	1 µA	0.0175 % of rdg. + 2 µA	Rin < 25 Ω
4-20 mA	1 µA	0.0175 % of rdg. + 2 µA	Rin < 25 Ω
0-20 mA	1 µA	0.0175 % of rdg. + 2 µA	Rin < 25 Ω

Temperature coefficient < 10 ppm/°C from 0°C to 18°C and from 28°C to 50 °C.

- Loop power supply = 24 V ± 10%.
- HART compatibility: input impedance Rin = 280 Ω
- Linear or square law display scale.

Use the absolute value of the value measured (|L|) to calculate the accuracy.

D.1.3 Resistance measurement

Range	Resolution	Accuracy	Notes
400 Ω	1 m Ω	0.012 % of rdg. + 10 m Ω	Measurement current = 0.25 mA
4000 Ω	10 m Ω	0.012 % of rdg.+ 100 m Ω	Measurement current = 0.25 mA

Temperature coefficient < 5 ppm/°C from 0°C to 18 °C and from 28 °C to 50 °C.

- Automatic detection of connection scheme: 2 wire, 3 wire or 4 wire.

- For 2 wire connection, the measurement includes the resistance of the line.
- For 3 wire connection, add the out-of-balance of the line resistances.
- Open circuit terminal voltage < 10V.
- Continuity test:
 - Open circuit for $R > 1000 \Omega$
 - Closed circuit for $R < 1000 \Omega$

D.1.4 Temperature measurement (Thermocouple)

Sensor types:

- in accordance with CEI 584-1/1995 (couples K, T, J, E, S, B, N),
- in accordance with Din 43710 (couples U and L),
- in accordance with the HOSKINS tables (couple C),
- in accordance with the ENGELHARD table (platinum couple).

Sensor	Measuring range	Resolution	Accuracy
K	-250 up to -200 °C	0.2 °C	0.80 °C
	-200 up to -120 °C	0.1 °C	0.25 °C
	-20 up to 0 °C	0.05 °C	0.1 °C
	0 up to 1372 °C	0.05 °C	0.013 % of rdg. + 0.08 °C
T	-250 up to -200 °C	0.2 °C	0.70 °C
	-200 up to -120 °C	0.05 °C	0.25 °C
	-120 up to -50 °C	0.05 °C	0.10 °C
	-50 up to 400 °C	0.05 °C	0.013 % of rdg. + 0.08 °C
J	-210 up to -120 °C	0.05 °C	0.25 °C
	-120 up to 0 °C	0.05 °C	0.09 °C
	0 up to 1200 °C	0.05 °C	0.013 % of rdg. + 0.07 °C
E	-250 up to -200 °C	0.1 °C	0.45 °C
	-200 up to -100 °C	0.05 °C	0.15 °C
	-100 up to 0 °C	0.05 °C	0.07 °C
	0 up to 1000 °C	0.05 °C	0.013 % of rdg. + 0.05 °C
R	-50 up to 150 °C	0.5 °C	0.8 °C
	150 up to 550 °C	0.2 °C	0.013 % of rdg. + 0.35 °C
	550 up to 1768 °C	0.1 °C	0.013 % of rdg. + 0.2 °C
S	-50 up to 150 °C	0.5 °C	0.80 °C
	150 up to 550 °C	0.2 °C	0.013 % of rdg. + 0.35 °C
	550 up to 1768 °C	0.1 °C	0.013 % of rdg. + 0.25 °C
B	400 up to 900 °C	0.2 °C	0.013 % of rdg. + 0.4 °C
	900 up to 1820 °C	0.1 °C	0.013 % of rdg. + 0.2 °C
U	-200 up to 660 °C	0.05 °C	0.15 °C
L	-200 up to 900 °C	0.05 °C	0.2 °C
C	-20 up to 900 °C	0.1 °C	0.25 °C
	900 up to 2310 °C	0.1 °C	0.013 % of rdg. + 0.15 °C
N	-240 up to -190 °C	0.2 °C	0.5 °C
	-190 up to -110 °C	0.1 °C	0.15 °C
	-110 up to 0 °C	0.05 °C	0.08 °C
	0 up to 1300 °C	0.05 °C	0.013 % of rdg. + 0.06 °C
Platinum	-100 up to 1400 °C	0.05 °C	0.3 °C
Mo	0 up to 1375 °C	0.05 °C	0.013 % of rdg. + 0.06 °C
NiMo/NiCo	-50 up to 1410 °C	0.05 °C	0.013 % of rdg. + 0.30 °C

The precision is guaranteed for a reference junction temperature of 0 °C.

When using the internal reference junction (except couple B) add an additional uncertainty of 0.3 °C at 0 °C. For other temperatures, account must be taken of the sensitivity of the thermocouple to the temperature (T) in question, giving an additional uncertainty of $0.3 \text{ °C} \cdot S(0 \text{ °C})/S(T)$.

- Temperature coefficient: < 10 % of the accuracy/ °C.

- Display in °C, °F and K.
- It is possible, thermocouple B excepted, to choose the location of the cold junction by programming from the keyboard:
 - external at 0 °C,
 - internal (compensation for the temperature of the terminals of the unit).
 - by programming the temperature.

D.1.5 Temperature measurement (RTDs)

Sensor	Range of measurement	Resolution	Accuracy
Pt 50($\alpha = 3851$)	-220 °C up to 1200 °C	0.01 °C	0.012 % of rdg. + 0.06 °C
Pt 100 ($\alpha = 3851$)	-220 °C up to 1200 °C	0.01 °C	0.012 % of rdg. + 0.05 °C
JPt 100 ($\alpha = 3916$)	-200 °C up to 510 °C	0.01 °C	0.012 % of rdg. + 0.05 °C
Pt 100 ($\alpha = 3926$)	-210 °C up to 850 °C	0.01 °C	0.012 % of rdg. + 0.05 °C
Pt 200 ($\alpha = 3851$)	-220 °C up to 600 °C	0,01 °C	0.012 % of rdg. + 0.12 °C
Pt 500 ($\alpha = 3851$)	-220 °C up to 1200 °C	0.01 °C	0.012 % of rdg. + 0.07 °C
Pt 1 000 ($\alpha = 3851$)	-220 °C up to 1200 °C	0.01 °C	0.012 % of rdg. + 0.05 °C
Ni 100 ($\alpha = 618$)	-60 °C up to 180 °C	0.01 °C	0.012 % of rdg. + 0.03 °C
Ni 120 ($\alpha = 672$)	-40 °C up to 205 °C	0.01 °C	0.012 % of rdg. + 0.03 °C
Ni 1 000 ($\alpha = 618$)	-60 °C up to 180 °C	0.01 °C	0.012 % of rdg. + 0.03 °C
Cu 10 ($\alpha = 427$)	-70 °C up to 150 °C	0.01 °C	0.012 % of rdg. + 0.18 °C
Cu 50 ($\alpha = 428$)	-50 °C up to 150 °C	0.01 °C	0.012 % of rdg. + 0.06 °C

For negative temperatures, use the displayed value L and not its absolute value.

Temperature coefficient: < 10 % of the accuracy/ °C.

The above accuracy is given for 4 wire connection of the temperature sensor.

Taking into account, also, the intrinsic error of the temperature sensor used and its conditions of use.

Measurement current: 0.25 mA

D.1.6 Frequency measurement and counting

Range	Resolution	Accuracy	Notes
20 kHz	< 0.01 Hz	0.005 % of rdg.	

- Temperature coefficient < 5 ppm/ °C from 0 °C to 18 °C and from 28 °C to 50 °C.
- Triggering level 1V
- Scale in beats/min and Hz
- Measurement for frequency output and dry contact
- In the case of counting, this measurement may be made for a defined time or an infinite time.

D.1.7 Additional features at measurement mode

D.1.7.1 Manual or automatic range selection

For the mV, V and Ω functions, with automatic range selection, the unit selects a higher or lower range.

D.1.7.2 Relative measurement

The relative measurement function is used to:

- program a reference value other than that of the unit (ZERO function),
- cancel by measurement or programming a constant or interfering value (TARE function).

D.1.7.3 Scale correction

The scale correction function performs a conversion between measured electrical quantities and the physical quantities converted.

D.1.7.4 Linearisation

Linearisation is used partially to correct errors induced by non linear sensor/converter systems.

D.1.7.5 Statistics

Display of the minimum, maximum and average value and the number of measurement points. The statistics may be reset to zero.

D.2 Transmission / simulation function

Maximum rated voltage in common mode: 60 VDC or VAC.

D.2.1 Voltage generation (DC)

Range	Resolution	Accuracy	Notes
100 mV	1 μ V	0.013 % of rdg. + 3 μ V	Output load min = 1 K Ω
2 V	10 μ V	0.013 % of rdg. + 20 μ V	Output load min = 2 K Ω
20 V	100 μ V	0.015 % of rdg. + 200 μ V	Output load min = 4 K Ω

Temperature coefficient < 7 ppm/ $^{\circ}$ C from 0 $^{\circ}$ C to 18 $^{\circ}$ C and from 28 $^{\circ}$ C to 50 $^{\circ}$ C.
Settling time: < 5 ms.

D.2.2 Current generation (DC)

Range	Resolution	Accuracy	Notes
24 mA	1 μ A	0.0175 % of rdg. + 2 μ A	
4-20 mA	1 μ A	0.0175 % of rdg. + 2 μ A	
0-20 mA	1 μ A	0.0175 % of rdg. + 2 μ A	

Temperature coefficient < 10 ppm/ $^{\circ}$ C from 0 $^{\circ}$ C to 18 $^{\circ}$ C and from 28 $^{\circ}$ C to 50 $^{\circ}$ C.
Settling time: < 5 ms.

D.2.3 Resistance generation

Range	Resolution	Accuracy	Notes
40 Ω	1 m Ω	0.014 % of rdg. + 3 m Ω 0.014 % of rdg. + 10 m Ω	(1) lext =10 mA (2) lext =1 mA
400 Ω	10 m Ω	0.014 % of rdg. + 20 m Ω 0.014 % of rdg. + 30 m Ω	(1) lext from 1 to 10 mA (2) lext from 0.1 to 1 mA
4000 Ω	100 m Ω	0.014 % of rdg. + 300 m Ω	lext from 0.1 to 1 mA

Temperature coefficient < 5 ppm/ $^{\circ}$ C from 0 $^{\circ}$ C to 18 $^{\circ}$ C and from 28 $^{\circ}$ C to 50 $^{\circ}$ C.
Settling time: < 1 ms.

D.2.4 Temperature simulation (Thermocouple)

Sensor types:

- in accordance with CEI 584-1/1995 (couples K, T, J, E, S, B, N),
- in accordance with Din 43710 (couples U and L),
- in accordance with the HOSKINS tables (couple C),
- in accordance with the ENGELHARD table (platinum couple).

Sensor	Range	Resolution	Accuracy
K	-240 up to -50 °C	0.2 °C	0.60 °C
	-50 up to 0 °C	0.1 °C	0.10 °C
	0 up to 1372 °C	0.05 °C	0.013 % of rdg. +0.08 °C
T	-240 up to -100 °C	0.2 °C	0.40 °C
	-100 up to 0 °C	0.05 °C	0.10 °C
	0 up to 400 °C	0.05 °C	0.013 % of rdg. +0.08 °C
J	-210 up to 0 °C	0.05 °C	0.20 °C
	0 up to 1200 °C	0.05 °C	0.013 % of rdg. +0.07 °C
E	-240 up to -100 °C	0.1 °C	0.25 °C
	-100 up to 40 °C	0.1 °C	0.10 °C
	40 up to 1000 °C	0.05 °C	0.013 % of rdg. +0.05 °C
R	-50 up to 350 °C	0.5 °C	0.5 °C
	350 up to 900 °C	0.2 °C	0.013 % of rdg. +0.35 °C
	900 up to 1768 °C	0.1 °C	0.013 % of rdg. +0.2 °C
S	-50 up to 120 °C	0.5 °C	0.8 °C
	120 up to 450 °C	0.2 °C	0.013 % of rdg. +0.35 °C
	450 up to 1768 °C	0.1 °C	0.013 % of rdg. +0.25 °C
B	400 up to 850 °C	0.2 °C	0.013 % of rdg. +0.4 °C
	850 up to 1820 °C	0.1 °C	0.013 % of rdg. + 0.2 °C
U	-200 up to 600 °C	0.05 °C	0.15 °C
L	-200 up to 900 °C	0.05 °C	0.20 °C
C	-20 up to 900 °C	0.1 °C	0.25 °C
	900 up to 2310 °C	0.1 °C	0.013 % of rdg. + 0.15 °C
N	-240 up to -190 °C	0.2 °C	0.3 °C
	-190 up to -110 °C	0.1 °C	0.15 °C
	-110 up to 0 °C	0.05 °C	0.08 °C
	0 up to 1300 °C	0.05 °C	0.013 % of rdg. +0.06 °C
Platinum	-100 up to 1400 °C	0.05 °C	0.3 °C
Mo	0 up to 1375 °C	0.05 °C	0.013 % of rdg. +0.06 °C
NiMo/NiCo	-50 up to 1410 °C	0.05 °C	0.013 % of rdg. +0.30 °C

The precision is guaranteed for a reference junction temperature of 0 °C.

When using the internal reference junction (except couple B) add an additional uncertainty of 0.3 °C at 0 °C. For other temperatures, account must be taken of the sensitivity of the thermocouple to the temperature (T) in question, giving an additional uncertainty of $0.3 \text{ °C} \cdot S(0 \text{ °C})/S(T)$.

- Temperature coefficient: < 10 % of the accuracy/ °C.
- Display in °C, °F and K.
- It is possible, thermocouple B excepted, to choose by programming the position of the cold junction with the keyboard:
 - external at 0 °C,
 - internal (compensation for the temperature of the terminals of the unit).
 - by programming the temperature.

D.2.5 Temperature simulation (RTDs)

Sensor	Range	Resolution	Accuracy
Pt 50 ($\alpha = 3851$)	-220 °C up to 1200 °C	0.03 °C	0.014 % of rdg. + 0.18 °C
Pt 100 ($\alpha = 3851$)	-220 °C up to 1200 °C	0.02 °C	0.014 % of rdg. + 0.12 °C
JPt 100 ($\alpha = 3916$)	-200 °C up to 510 °C	0.02 °C	0.014 % of rdg. + 0.12 °C
Pt 100 ($\alpha = 3926$)	-210 °C up to 850 °C	0.02 °C	0.014 % of rdg. + 0.12 °C
Pt 200 ($\alpha = 3851$)	-220 °C up to 600 °C	0.10 °C	0.014 % of rdg. + 0.33 °C
Pt 500 ($\alpha = 3851$)	-220 °C up to 1200 °C	0.03 °C	0.014 % of rdg. + 0.18 °C
Pt 1 000 ($\alpha = 3851$)	-220 °C up to 1200 °C	0.02 °C	0.014 % of rdg. + 0.08 °C
Ni 100 ($\alpha = 618$)	-60 °C up to 180 °C	0.01 °C	0.014 % of rdg. + 0.08 °C
Ni 120 ($\alpha = 672$)	-40 °C up to 205 °C	0.01 °C	0.014 % of rdg. + 0.08 °C
Ni 1 000 ($\alpha = 618$)	-60 °C up to 180 °C	0.01 °C	0.014 % of rdg. + 0.08 °C
Cu 10 ($\alpha = 427$)	-70 °C up to 150 °C	0.01 °C	0.014 % of rdg. + 0.10 °C
Cu 50 ($\alpha = 428$)	-50 °C up to 150 °C	0.03 °C	0.014 % of rdg. + 0.15 °C

For negative temperatures, use the value displayed L and not its absolute value.

- Temperature coefficient: < 10 % of the accuracy/ °C.
- The above accuracy is given for 4 wire connection of the temperature sensor.
- Taking into account, also, the intrinsic error of the temperature sensor used and its conditions of use.
- Measurement current: from 0.1 mA to 1 mA
- Settling time: < 1 ms

D.2.6 Frequency and pulses generation

Range	Resolution	Accuracy	Notes
1000 Hz	0.01 Hz	0.005 % of rdg.	(1)
10 kHz	1 Hz	0.005 % of rdg.	(1)

(1) Note that the captured value may differ from the displayed value. The frequency generated is derived from a fixed frequency by dividing it by a whole number. The displayed value (within the resolution of the display) is, therefore, this value recalculated with the fastest approximation to the captured value. The frequency actually generated is the displayed value to within the uncertainty specified in this table. Temperature coefficient < 5 ppm/ °C from 0 °C to 18 °C and from 28 °C to 50 °C.

D.2.7 Additional features at simulation mode

D.2.7.1 Generation of increments

The increment generation function is used to program an incremental progression of the active transmission function.

D.2.7.2 Generation of ramps

The ramp generation function is used to program a linear variation of the active transmission function.

D.2.7.3 Synthesiser

The synthesiser function is used:

- to store up to 100 transmission values in permanent memory,
- to recall and transmit manually or automatically the contents of these memories.

D.2.7.4 Scale correction

The scale correction function performs a conversion between the physical quantities displayed and the electrical quantities simulated.