



KERN & Sohn GmbH

Ziegelei 1
D-72336 Balingen
E-Mail: info@kern-sohn.com

Tel: +49-[0]7433- 9933-0
Fax: +49-[0]7433-9933-149
Internet: www.kern-sohn.com

Operating instructions Hand Grip Dynamometer

KERN MAP

Version 1.2
08/2012
GB



MAP-BA-e-1212



KERN MAP

Version 1.2 08/2012

Hand Grip Dynamometer

Table of Contents

1	Technical Data	3
2	Appliance overview	8
3	Basic Information (General).....	9
4	Basic Safety Precautions	10
5	Transportation & Storage.....	10
6	Removing packaging and initial start-up.....	11
7	Operation.....	18
8	Service, maintenance, disposal.....	28
9	Error messages.....	29

English

1 Technical Data

KERN	MAP 80K1		
Capacity	80 kg (blue)	40 kg (green)	20 kg (red)
			
Readability (d)	0.1 kg / 0.2 lb		
Units	kg, lb		
Auto Off	After 1 min without change of load		
Electric Supply	1 x CR2450 Service life 53 h		
Operating temperature	+ 5°C ... + 35°C		
Storage temperature	- 20°C ... + 60°C		
Humidity of air	max. 80 % (not condensing)		
Dimensions fully mounted (W x D x H) mm	212 x 55 x 102		
Weight g (net)	300		

KERN	MAP 80K1S			
Capacity	80 kg	40 kg	20 kg	10 kg
	(blue)	(green)	(red)	(yellow)
				
Readability (d)	0.1 kg / 0.2 lb			
Units	kg, lb			
Auto Off	After 1 min without change of load			
Electric Supply	1 x CR2450 Service life 53 h			
Operating temperature	+ 5°C ... + 35°C			
Storage temperature	- 20°C ... + 60°C			
Humidity of air	max. 80 % (not condensing)			
Dimensions fully mounted (W x D x H) mm	212 x 55 x 88			
Weight g (net)	300			

KERN	MAP 130K1		
Capacity	130 kg (white)	80 kg (blue)	40 kg (green)
			
Readability (d)	0.1 kg / 0.2 lb		
Units	kg, lb		
Auto Off	After 1 min without change of load		
Electric Supply	1 x CR2450 Service life 53 h		
Operating temperature	+ 5°C ... + 35°C		
Storage temperature	- 20°C ... + 60°C		
Humidity of air	max. 80 % (not condensing)		
Dimensions fully mounted (W x D x H) mm	212 x 55 x 102		
Weight g (net)	300		

1.1 Dimensions
MAP 80K1S:

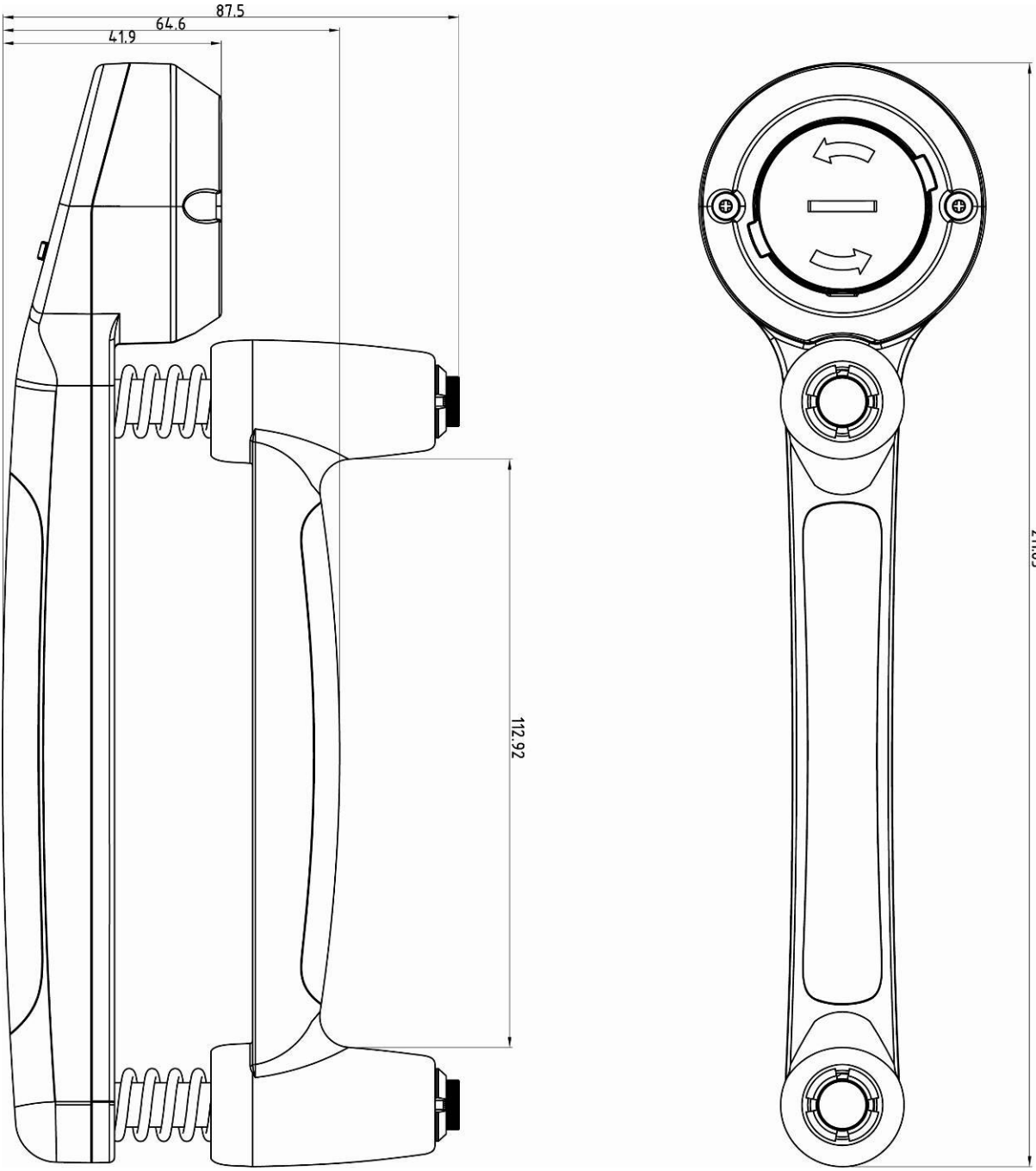

MAP 80K1 , MAP 130K1

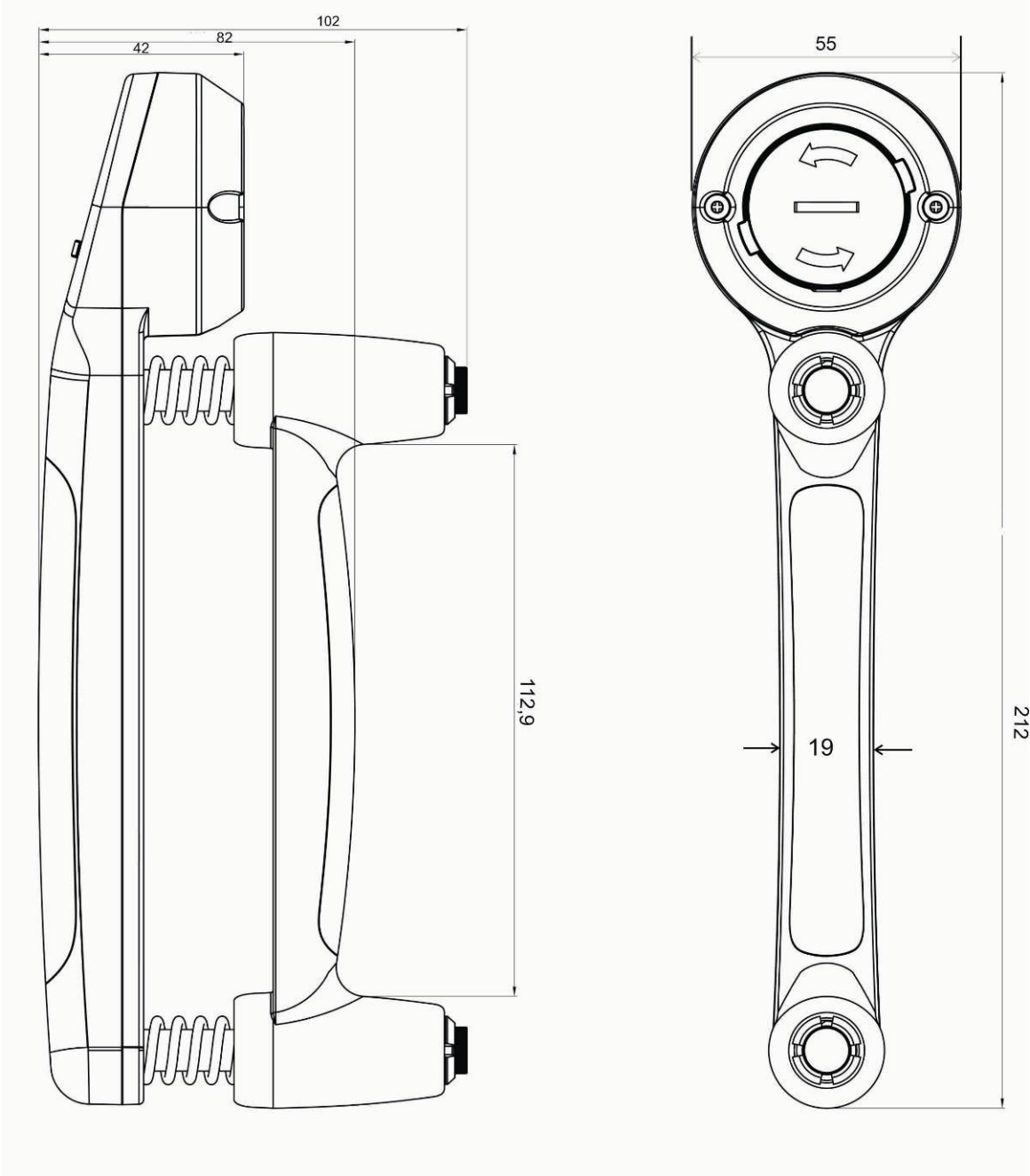

2 Appliance overview



1. Battery compartment, see chapter 7
2. Display, see chapter. 8
3. Keyboard, see chapter. 8
4. Spring set, see chapter. 7

Transport case



3 Basic Information (General)

Intended use This device allows medical staff to test a patient's fitness status and to carry out controlled training during the rehabilitation process.

The appliance should be checked for correct condition prior to each utilisation by a person familiar with proper operation of the balance.

Non-intended use Changes to the unit's design are not permitted. This may lead to incorrect measuring results, safety-related faults and destruction of the unit.

The unit may only be operated in accordance with the described default settings. Other areas of use must be released by KERN in writing.

Warranty Warranty claims shall be voided in case

- Our conditions in the operation manual are ignored
- The appliance is used outside the described uses
- The appliance is modified or opened
- Mechanical damage and damage caused by media, liquids
- Natural wear and tear
- Non-intended use or electric installation
- The measuring system is overloaded
- Dropping the balance

Test device control As a precautionary measure during quality control, the metrological features of the device have to be tested on a regular basis. The responsible user must define a suitable interval as well as type and scope of this test. For further information please go to KERN-Homepage (HYPERLINK <http://www.kern-sohn.com> under www.kern-sohn.com).

4 Basic Safety Precautions



- ⇒ Carefully read this operation manual before setup and commissioning, even if you are already familiar with KERN balances.
- ⇒ Versions in other languages are non-binding translations. The only binding version is the original document in German.

Staff training The medical staff must apply and follow the operating instructions for proper use and care of the product.

5 Transportation & Storage

Testing upon acceptance When receiving the appliance, please check packaging immediately, and the appliance itself when unpacking for possible visible damage.

Packing Keep all parts of the original packaging in case you need to return the appliance.
Only use original packaging for returning.

6 Removing packaging and initial start-up

Place of application

The unit is designed to achieve reliable measuring results under normal conditions of use.

Required conditions for place of operation:

- Prevent extreme heat and temperature fluctuations
- Protect the appliance against high humidity, vapours and dust;
- Do not expose the device to extreme dampness for longer periods of time. Non-permitted condensation (condensation of air humidity on the appliance) may occur if a cold appliance is taken to a considerably warmer environment. If present, acclimatise device.
- Avoid static charge
- Avoid contact with water.

If electro-magnetic fields or static charge occur, or if the power supply is unstable major deviations on the display (incorrect weighing results) are possible. In that case, the location must be changed.

Scope of supply

- Device, see chapter. 3
- Carrier case
- 3 Spring sets
- Operating instructions
- Battery

How to replace a spring set

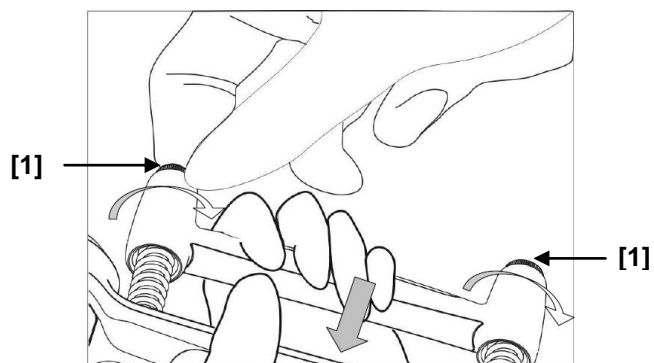

1. Press device until the two screws [1] become visible.
2. Remove screws.

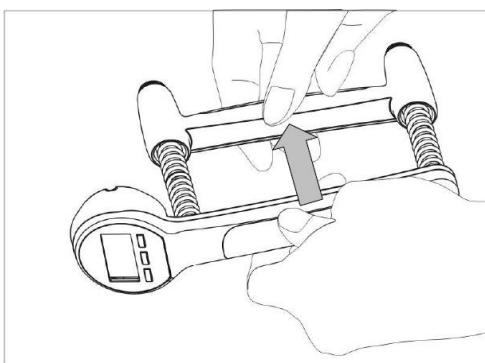

3. Remove grip first, followed by springs.

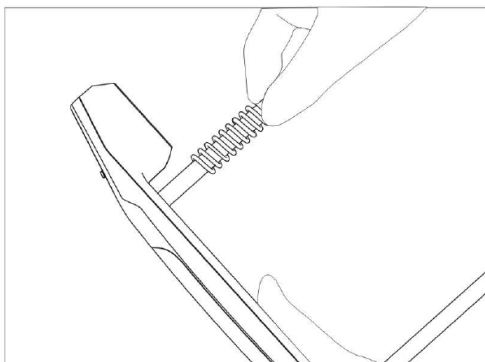

4. Insert desired spring set.
5. Reassemble device in reverse order.

i

Install two additional washers **only** in the 130 kg-spring set. (s. fig.)

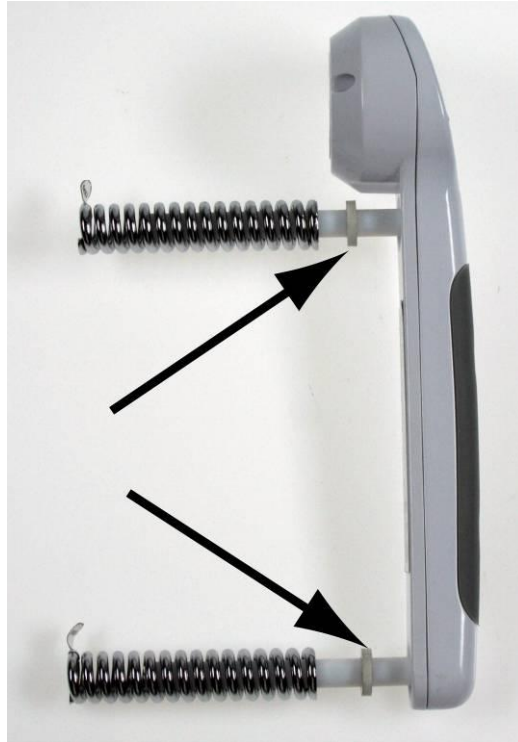

Battery operation

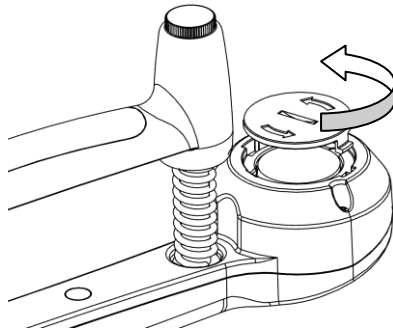

1. Open battery cover, as shown on illustration.

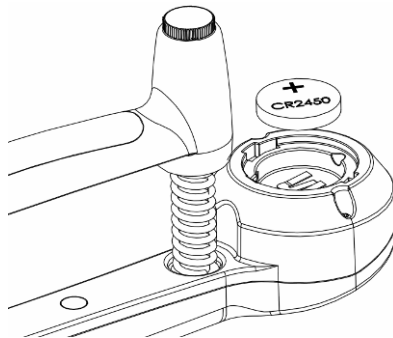

2. Replace battery (CR-2450).

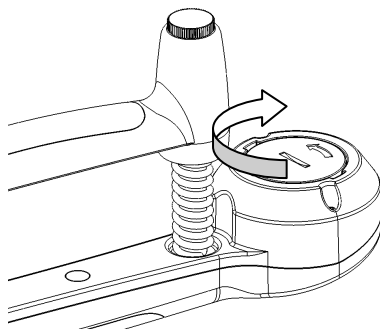

3. Reinsert the battery cover.

To save battery power, the device auto-disconnects automatically after 60 seconds have passed without a change of display.

If the batteries are run down soon, "LO" appears in the display. Replace battery.

If the balance is not used for a longer time, take out the batteries and store them separately. Leaking battery liquid could damage the balance.

Commissioning

Correct

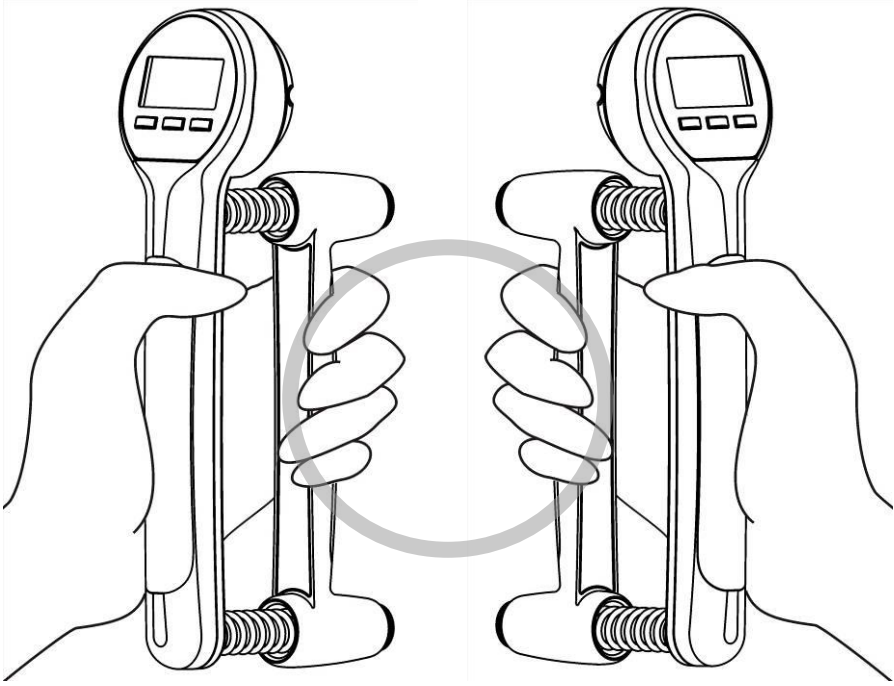

left hand

right hand

Correct

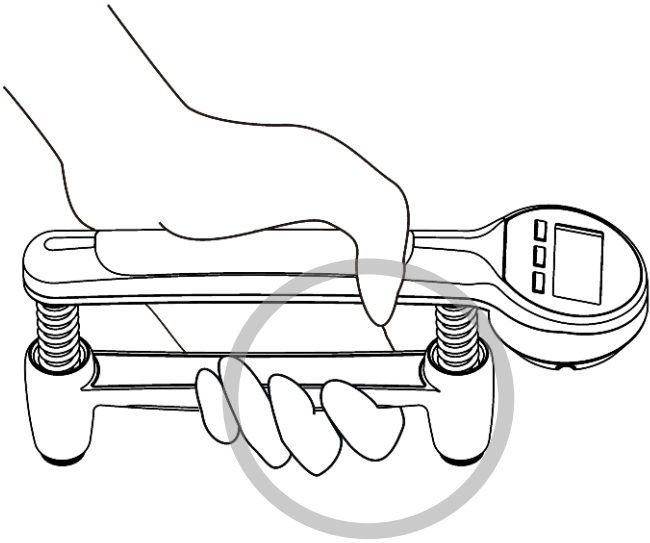

left hand

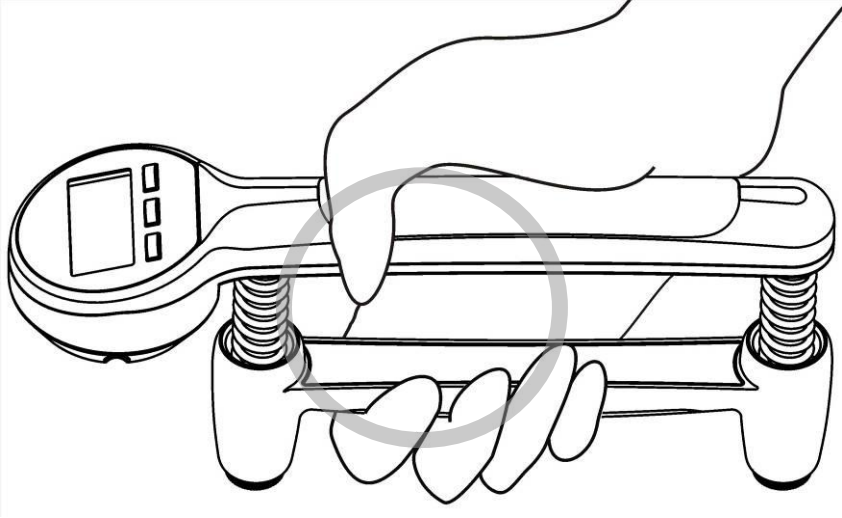

right hand

wrong

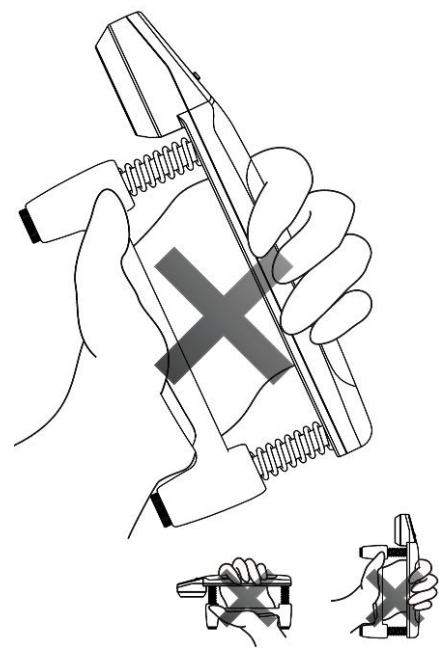
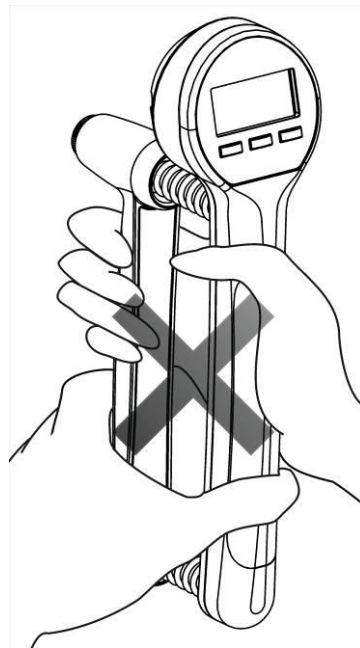
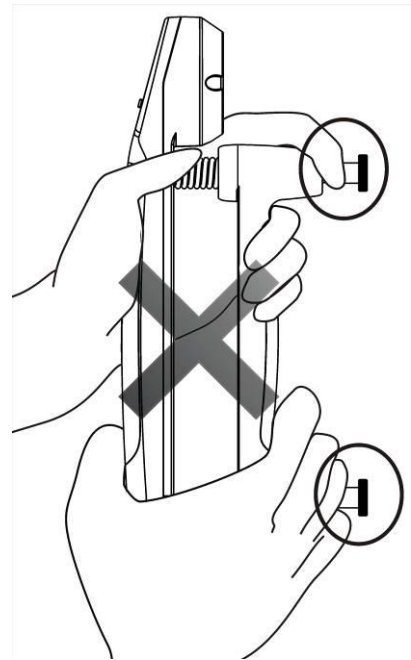
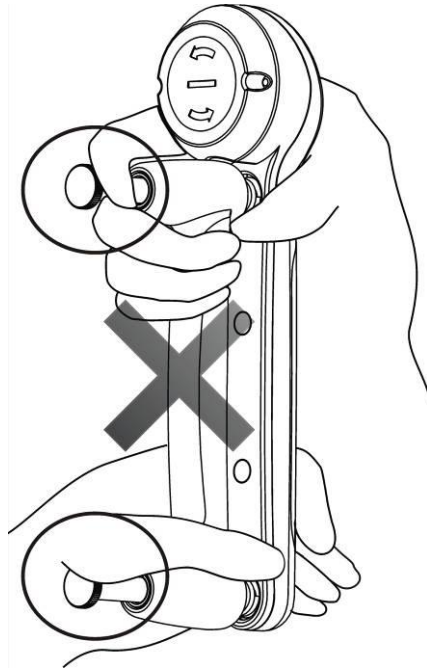

7 Operation

Overview of displays



1. Stability display
2. Battery status
3. Operation modus
4. Percentage display
5. Weighing unit "lb"
6. Weighing unit "kg"

Keyboard overview

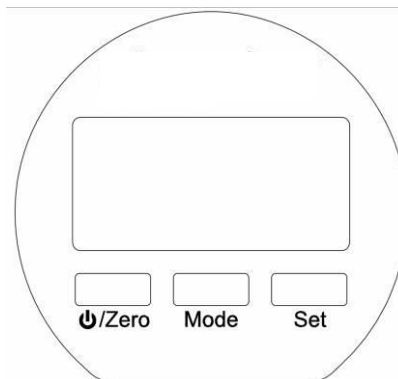



Button	Function
⏻ / Zero	Switch-on / off, zeroing
Mode	Select operating mode
Set	Confirm display
	In real mode: Switch unit from kg ↔ to lb

**Turn on/off
Zeroing**

- ⇒ Switch on the device by pressing the /zero key. Zero display appears.









- ⇒ If the device does not exactly show zero, unload the device and press the /zero key.
- ⇒ To switch off, keep /zero key pressed for approx. 3 seconds.

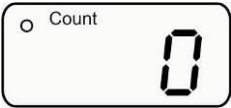

During power-up the device will return to the mode or unit (kg/lb) it had been in before it was switched off.

7.1 Operating modes

The device is in real mode at delivery. Use the mode key to switch over the device to the following operating modes.

Operating mode	Display	Function
Real time mode		Shows current strength.
 ↓		
Counting mode		Counts number of gripping actions exceeding a previously set strength limit.
 ↓		
Average mode		Calculates the average strength derived from two hand grips
 ↓		
Peak/Max Mode		Shows max strength of hand grip.

Real time mode

1. Show actual strength

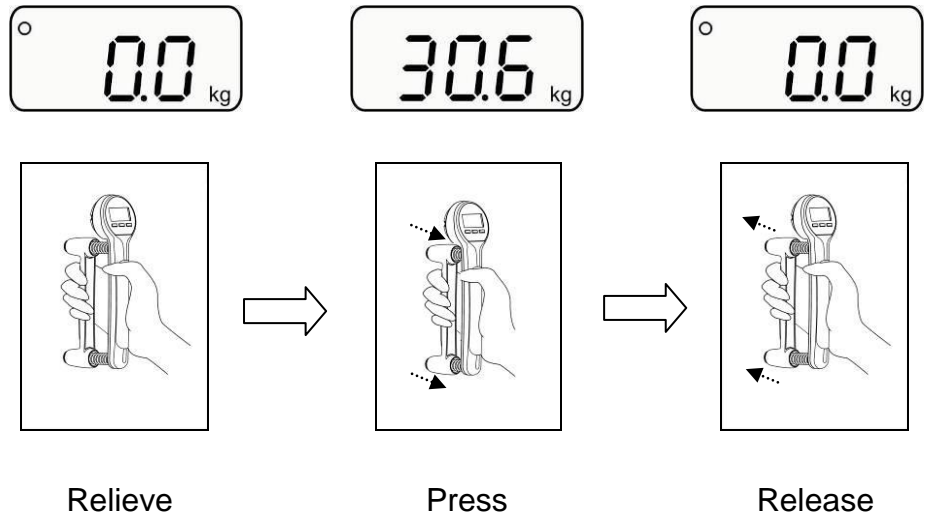

2. Change unit kg ↔ lb

In real mode it is possible to switch from “kg” to “lb” by pressing the **set** key – and vice versa.

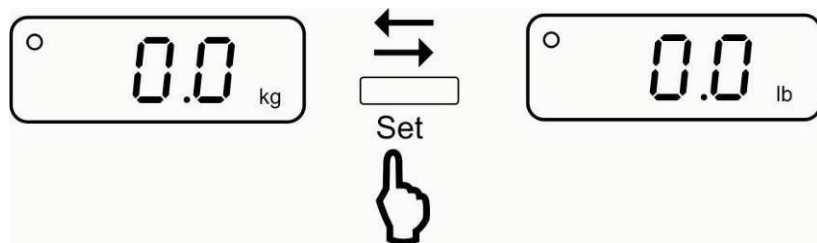

During power-up the device will return to the mode or unit it had been in before it was switched off.

Counting mode

1. Call mode

- ⇒ Switch on the device by pressing the /zero key.
- ⇒ Press **mode** key repeatedly until the count display appears.

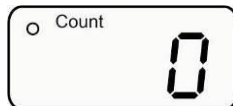

2. How to define the strength limit

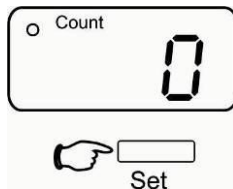

The currently set strength limit is displayed.

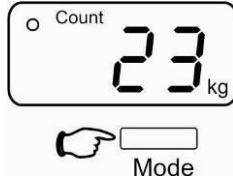

To change, press the **mode** key repeatedly until the desired strength limit is displayed. Ensure that the capacity of the spring is not exceeded (e. g. strength limit for 20 kg spring set < 20 kg).

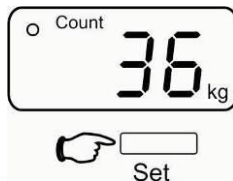

Confirm by pressing the **set** key; count display appears.

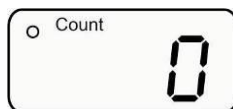

3. Counting gripping actions

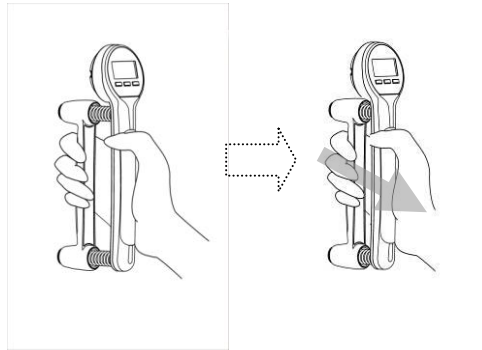

Press, and release device as often as possible.
Each gripping action is acknowledged by an audio sound.

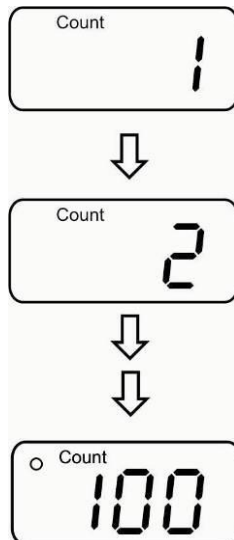

The number of gripping actions carried out will be shown on screen.

4. Start further counting

Press the /Zero button, the zero display disappears.

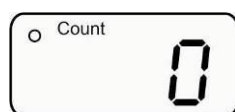

Count gripping actions as described under item 3.

Average mode

1. Call mode

- ⇒ Switch on the device by pressing the /zero key.
- ⇒ Press **mode** key repeatedly until avg. display appears.



2. Determine average strength from two hand grips



Carry out first gripping action

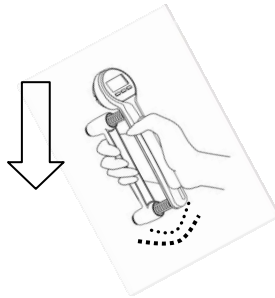

Strength of first hand grip will be shown.

Carry out second gripping action.

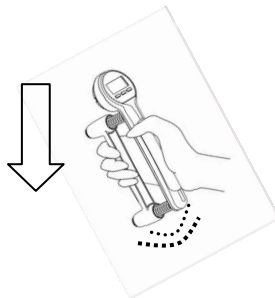

Strength of second hand grip will be shown.

Press the **set** key; average strength derived from the two hand grips will be calculated and displayed flashing.



3. Start further measurements

To return to measuring mode, press the **set** key.



Press the **⏻/Zero** button, the zero display disappears.



Carry out further measurements as described under item 2.

Peak/Max-Mode

1. Call mode

- ⇒ Switch on the device by pressing the /zero key.
- ⇒ Press the **mode** key repeatedly until max display appears.



2. Carrying Out Measurement

Example:

Example: A gripping action achieves a strength of 50 kg.
Now you are able to determine whether follow-up measurements also reach 50 kg = 100% or for example only 31% = 15.5 kg (adjustable range 1-100 %)



Carry out gripping action

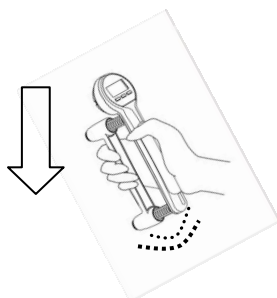

The strength of the first hand grip will be displayed and can be stored by pressing the **set** key.



The display shows the currently set percentage value.



To change, press the **mode** key repeatedly until the desired percentage appears. Use the **Set** key to confirm.



If a new gripping action shows a strength of less than for instance $< 31\%$ ($< 15.5\text{ kg}$), the previous max value will be retained.

If a new gripping action shows a strength greater than for instance $> 31\%$ ($> 15.5\text{ kg}$), the new max value will be displayed.

The previous max value will be overwritten with the new value.

8 Service, maintenance, disposal

Cleaning Please do not use aggressive detergents (solvents etc.). Apply soapy water to moist cloth or use household detergent. Prevent fluid from penetrating into device. Finish by polishing with dry soft cloth. Remove dirt immediately.

Service, maintenance The appliance may only be opened by trained service technicians who are authorized by KERN.

Disposal Disposal of packaging and appliance must be carried out by operator according to valid national or regional law of the location where the appliance is used.

9 Error messages

A rectangular LCD display showing the characters 'Lo' in a monospaced font.

Capacity of batteries exhausted. For replacing of batteries, see chapter. 7

A rectangular LCD display showing the character '0' in a monospaced font.

A rectangular LCD display showing four dots '....' in a monospaced font.

Underload, set to zero by pressing /zero key

A rectangular LCD display showing the characters 'Err' in a monospaced font.

Overload, release device

A rectangular LCD display showing the characters 'ErrL' in a monospaced font.

Preload error, put minor stress on device during power-up

A rectangular LCD display showing the characters 'ErrE' in a monospaced font.

EEPROM error, switch-off and restart device. If the error message remains inform manufacturer.