

Pallet scale KERN UFB

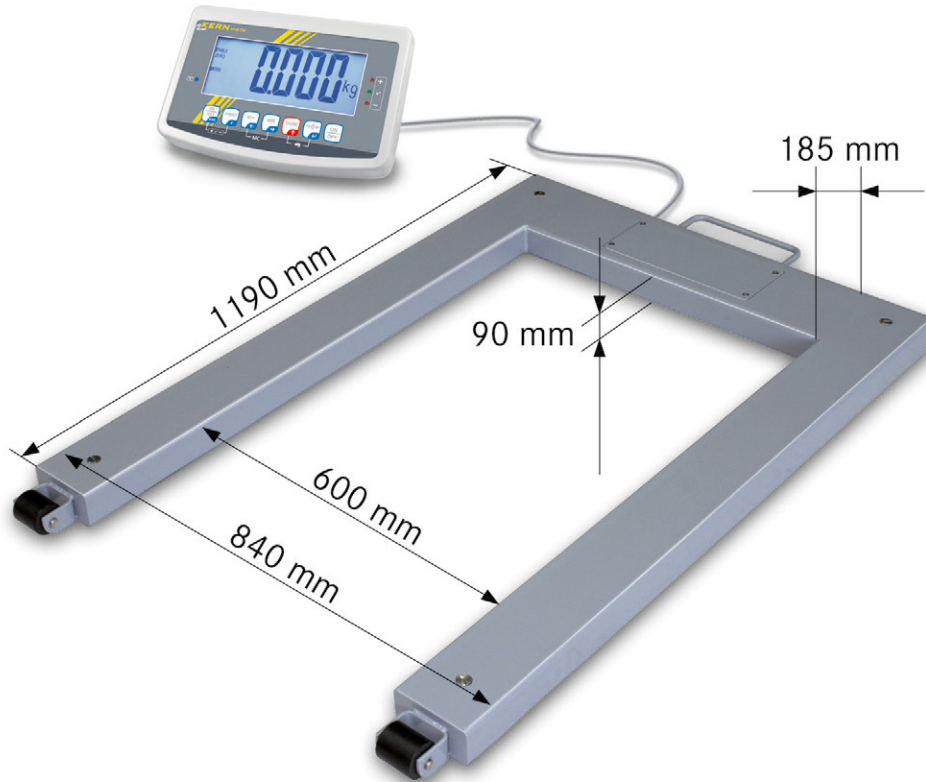

Mobile pallet scale with EC type approval [M]

Features

- **High mobility:** thanks to battery (optional) and compact, flat construction, it is suitable for use in several locations (production, warehouse, dispatch department,...)
- **2 rollers and handle** for easy transport of the scale
- **Dynamic weighing:** at the push of a button, a stable average weight is given when the environmental conditions are unstable or when weighing animals
- **Weighing with tolerance range (checkweighing):** Input of an upper/lower limit value. A visual and audible signal assists with portion division, dispensing or grading
- **Totalizing** of weights
- **Load cell steel, silicone-coated, IP67**
- **Load support solid steel construction,** lacquered, extremely resistant to bending
- **Display device KERN KFB-TM,** details see page 119

Technical data

- Large backlit LCD display, digit height 52 mm
- Cable length of display device approx. 5 m
- Permissible ambient temperature -10 °C / 40 °C
- Dimensions of display device WxDxH 250x160x58 mm
- Net weight approx. 43 kg

Accessories

- **Protective working cover** over the display device standard, can be reordered, KERN KFB-A02
- **Stand** to elevate display device, height of stand approx. 750 mm, similar to illustration, KERN BFS-A07
- **Rechargeable battery pack internal,** operating time up to 35 h, charging time approx. 12 h, must be ordered at purchase, KERN KFB-A01

1 Shipment via freight forwarder. Please ask for dimensions, gross weight, shipping costs

- **Signal lamp** for visual support of weighing with tolerance range, WxDxH 100x180x300 mm, see page 141, KERN CFS-A03
- **Y cable** for parallel connection of two terminal devices to the RS-232 interface on the balance, e.g. signal lamp and printer, KERN CFS-A04
- **Large display with superior display size,** details see page 141, KERN YKD-A02
- **Suitable printers** see page 138

STANDARD



OPTION



FACTORY





































only with printer

Model	Weighing range [Max] kg	Readout [d] g	Verific. value [e] g	Minimum load [Min] kg	Options			
					Verification		DKD Calibr. Certificate	
					M	KERN	DKD	KERN
UFB 600K200M	600	200	200	4	965-230		963-130	
UFB 1.5T0.5M	1500	500	500	10	965-230		963-130	

Note: For applications that require verification, please order verification at the same time, initial verification at a later date is not possible. Verification at the factory, we need to know the full address of the location of use.

KERN Pictograms

 Internal adjusting (CAL): Quick setting of the balance's accuracy with internal adjusting weight (motordriven).	 Recipe level A: Separate memory for the weight of the tare container and the recipe ingredients (net total).	 Rechargeable battery pack: rechargeable set.
 Adjusting program (CAL): For quick setting of the balance's accuracy. External adjusting weight required.	 Recipe level B: Internal memory for complete recipes with name and target value of the recipe ingredients. User guidance through displays.	 Mains adapter: 230V/50Hz in standard version for Germany. On request GB, AUS or USA version.
 Memory: Balance contains memories, e.g. for item data, weighing data, tare weights etc. PLU.	 Recipe level C: Internal memory for complete recipes with name and target value of the recipe ingredients. User guidance through displays. Additional convenient functions, such as barcode and back calculation functions.	 Power supply: integrated in balance. 230V/50Hz in Germany. More standards e. g. GB, AUS, USA on request.
 Data interface RS-232: To connect the balance to a printer, PC or network.		 Strain gauges: Electrical resistor on an elastic deforming body.
 RS 485 data interface: To connect the balance to a printer, PC or other peripheral devices. High tolerance against electromagnetic disturbance.	 Percentage determination: Determining the deviation in % from the target value (100%).	 Tuning fork principle: A resonating body is electromagnetically excited, causing it to oscillate.
 USB data interface: To connect the balance to a printer, PC or other peripheral devices.	 Weighing units: Can be switched to e. g. non-metric units at the touch of a key. See balance model. Please refer to KERN's website for more details.	 Electromagnetic force compensation: Coil in a permanent magnet. For the most accurate weighings.
 Bluetooth data interface: To transfer data from the balance to a printer, PC or other peripheral devices.	 Weighing with tolerance range: Upper and lower limiting can be programmed individually, e.g. dosing/sorting and portioning.	 Single cell technology: Advanced version of the force compensation principle with the highest level of precision.
 Control outputs (optocoupler, digital I/O): to connect relays, signal lamps, valves, etc.	 Vibration-free weighing: (Animal weighing program) Vibrations are filtered out so that a stable weight is obtained.	 Verification possible: The time required for verification is specified in the pictogram.
 Interface for second balance: for direct connection of a second balance.	 Spray and dust protection IPxx: The type of protection is shown by the pictogram. For details see the glossary.	 DKD calibration possible: The time required for DKD calibration is shown in days in the pictogram.
 Network interface: For connecting the scale to an Ethernet network. With KERN products you can also use a universal RS-232/LAN converter.	 Stainless steel: the balance is protected against corrosion.	 Package shipment: The time required to manufacture the product internally is shown in days in the pictogram.
 GLP/ISO record keeping: of weighing data with date, time and identification-no. Only with printers from KERN.	 Suspended weighing: load support with hook on the underside of the balance.	 Pallet shipment: The time required to manufacture the product internally is shown in days in the pictogram.
 Piece counting: Reference quantities selectable. Display can be switched from piece to weight.	 Battery operation: Ready for battery operation. The battery type is specified for each device.	 Warranty: The warranty period is shown in the pictogram.

Precision is our business

To ensure the high precision of your balance KERN offers you the appropriate test weight package for your balance, consisting of the test weight, box and DKD certificate, as proof of its accuracy ... the best pre-requisite for proper balance calibration.

In the extensive KERN test weight range, you will find test weights in the international OIML error limit classes: E1, E2, F1, F2, M1, M2, M3 with weights from 1 mg - 2000 kg.

The KERN DKD calibration laboratory for electronic balances and weights has been accredited by DKD since 1994 and today is one of the most modern and best-equipped DKD calibration laboratories for balances, test weights and force-measurement in Europe.

(DKD = German Calibration Service)

Thanks to the high level of automation, we can carry out DKD calibration of balances, test weights and force-measuring devices 24 hours a day, 7 days a week.

Range of services:

- DKD calibration of balances with a maximum load of up to 6 t
- DKD calibration of weights in the range of 1 mg – 500 kg
- Database supported management of checking equipment and reminder service
- Calibration of force-measuring devices
- DKD calibration certificates in the following languages
D, GB, F, I, E, NL, PL

Do you have questions about your scale, the corresponding test weight or the calibration service? Your KERN specialist dealer will be pleased to assist you.

Your KERN specialist dealer: