

Operating instructions Electronic Moisture Analyser

KERN DBS

Version 1.1
03/2013
GB





KERN DBS

Version 1.1 03/2013

Operating instructions

Electronic Moisture Analyser

Contents

1	Technical data	4
2	Appliance overview	6
2.1	Overview of display	8
2.1.1	Display examples.....	12
2.2	Keyboard overview	13
3	Basic Information (General)	15
3.1	Proper use.....	15
3.2	Improper Use.....	15
3.3	Warranty	15
3.4	Monitoring of Test Resources.....	15
3.5	Danger Information	16
3.5.1	“Hazard information” sticker	20
4	Transport and storage	21
4.1	Testing upon acceptance	21
4.2	Packaging / return transport	21
5	Unpacking, Setup and Commissioning	21
5.1	Installation Site, Location of Use	21
5.2	Unpacking and checking	24
5.2.1	Scope of delivery / serial accessories	24
5.3	Placing	25
5.4	Mains connection	28
5.4.1	Turning On the Power	29
5.5	Commissioning.....	30
5.6	Connection of peripheral devices.....	30
6	Adjustment	31
6.1	Adjust balance	31
6.2	Adjust temperature.....	33
6.3	ISO/GLP log.....	36
7	Menu	37
7.1	Navigation in the menu.....	38
7.1.1	Numeric entry.....	39
8	Moisture analysis	40
8.1	Start drying.....	40
8.2	Abort drying	42
8.3	Finish drying	42
8.4	Turn off appliance	42
9	Drying parameters	43

9.1	Save / access	44
9.2	Adjust.....	45
9.2.1	Drying modes.....	45
9.2.1.1	Drying mode AUTO (Standard drying/switch-off criterion "ΔM")	45
9.2.1.2	Drying mode TIME (Standard drying/switch-off criterion "Time")	46
9.2.1.3	RAPID Drying mode (Rapid drying)	47
9.2.1.4	SLOW Drying mode (Slow drying)	49
9.2.1.5	STEP Drying mode (Step drying)	51
9.2.2	Result display.....	54
9.2.3	Start criterion.....	56
10	Miscellaneous settings	57
10.1	Enter sample designation.....	57
10.2	Set date/time for measuring protocol.....	58
10.3	Menu Lock.....	59
10.4	Change password.....	61
10.5	Enter identification number.....	62
10.6	Resetting the menu	63
11	Print, store and call-up measurement results	64
11.1	Pin allocation RS232C interface.....	65
11.2	Interface parameters	66
11.3	Output interval	68
11.4	Call up and print out measuring results.....	69
11.5	Print out currently preset drying parameters	70
11.6	Delete measuring results from memory	71
11.7	Printout examples	72
12	General information concerning moisture analysis	75
12.1	Application	75
12.2	Basics	75
12.3	Adjustment to existing measuring method.....	75
12.4	Preparing a sample.....	76
12.5	Sample material	77
12.6	Sample size / originally weighted in quantity	77
12.7	Drying temperature.....	78
12.8	Recommendations / Guidelines	78
13	Service, maintenance, disposal.....	83
13.1	Cleaning.....	83
13.2	Service, maintenance.....	84
13.2.1	Remove protective glass guard.....	84
13.2.2	Lamp change.....	86
13.2.3	Replacing fuses.....	87
13.3	Disposal.....	87
14	Instant help.....	88
14.1	Error messages.....	89
15	Declaration of conformity	91

1 Technical data

Data	DBS 60-3
Radiator	Halogen (1 x 400 W)
Temperature range	50°C - 200°C 1°C increments selectable
Maximum load (Max)	60 g
Minimum weight (min)	0.02 g
Warm-up time	2 h
Readability (d)	Weighing mode 0.001g
	Moisture analysis mode 0.01 %
Reproducibility „Weighing mode“	0.001 g
Reproducibility „Weighing mode“	Initial weight 2 g: 0.15 %
	Initial weight 5g 0.05 %
	Initial weight 10 g 0.02 %
Drying modes	Standard drying (AUTO / TIME)) Step drying (STEP) Rapid drying (RAPID) Slow drying (SLOW)
Linearity	± 0.003 g
Stabilization time (typical)	3 sec.
Recommended adjustment weight, not added (class)	50g (F1)
Environmental conditions	<ul style="list-style-type: none"> • 5°C....+40°C ambient temperature • max 85% air humidity non-condensing

Switch-off criterion	<ul style="list-style-type: none"> • AUTO The drying is finished when the preset weight loss (ΔM) remains constant for 30 seconds. • TIME The drying is finished after the preset time, 1 minute – 4 hours (1 minute increments) or 12 hours can be selected • Manual (STOP button) 	
Sample dishes included	Ø 95 mm	
Weighing Units	[M/W]	[%] moisture
	[D/W]	[%] dry mass:
	[M/D]	ATRO* dry mass
	[W/D]	ATRO* moisture
	[GRAM]	Gram display
Internal memory	Method memory	10 memory locations for drying programs, see chap. 9.1
	Sample memory	100 memory locations for measuring results, see chap. 11
Interface	RS232	
Dimensions (B x D x H)	Housing 202 x 336 x 157 mm	
Available drying room	Ø 95 mm, 20 mm high	
Net weight	4.2 kg	
Electric Supply	220 – 240 V AC 50/60 Hz	
Power consumption	Rating 430 VA	
Voltage fluctuations	Within ± 10 %	
Power line fuse	3.15 A, 250V	
Interrupting rating of fuse	35 A	
Pollution Degree	2	
Overvoltage Category	Category II	
Altitude	Up to 2000 m	
Installation Site	device may only be used indoors	

2 Appliance overview

Front view:

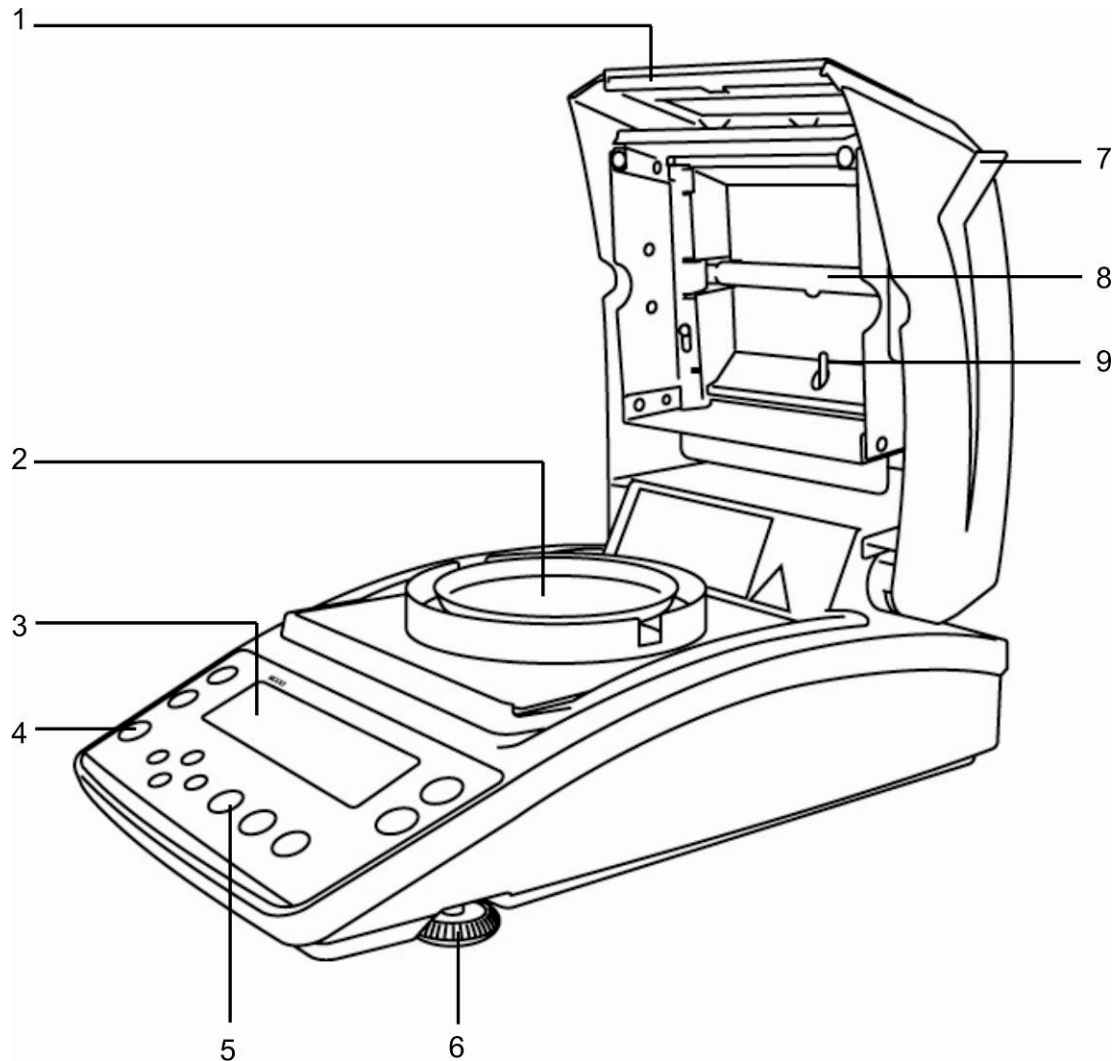

Pos.	Description
1	Viewing panel
2	Sample dish
3	Display
4	Bubble level
5	Keyboard
6	Adjustable foot
7	Heated cover
8	Halogen lamp
9	Temperature sensor

Rear view:

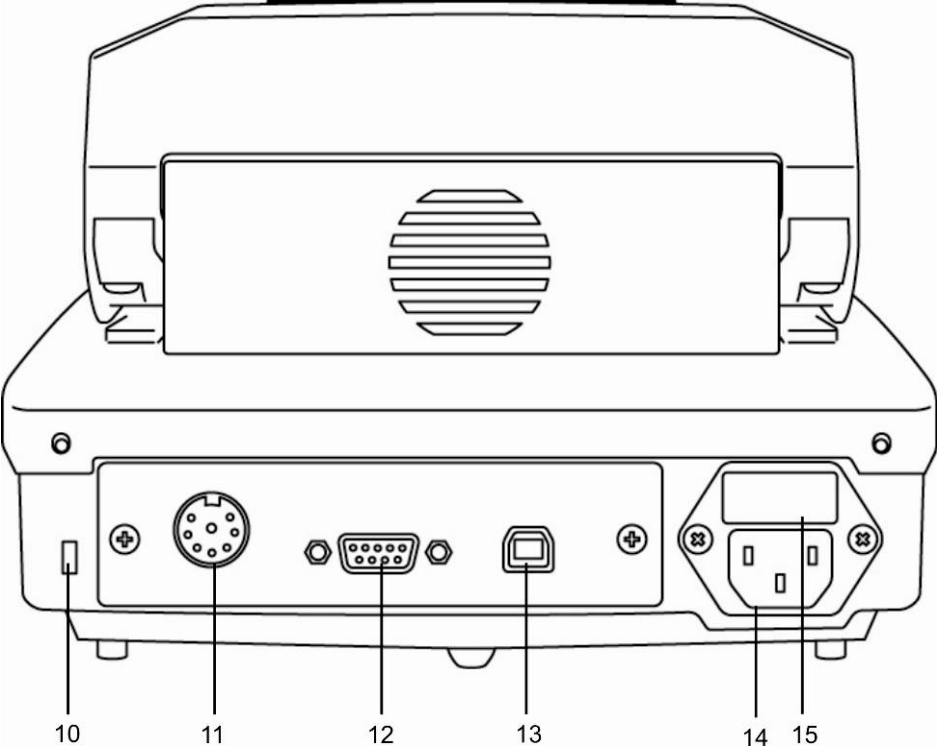





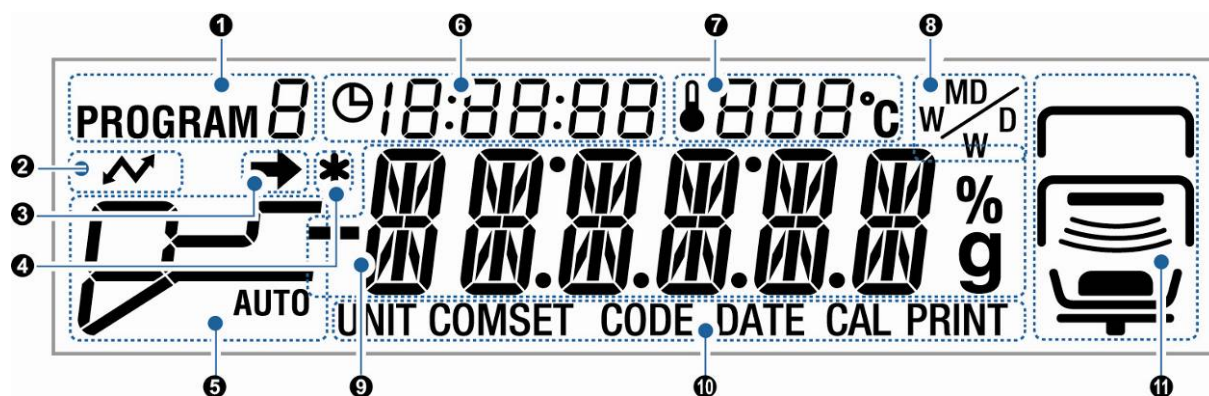



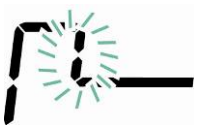
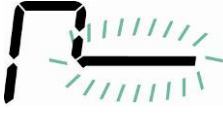

Pos.	Description
10	Anti-theft protection device connection
11	Not documented
12	RS232
13	USB, not documented
14	Mains connection socket
15	Fuse box

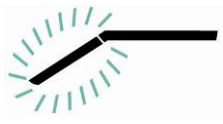
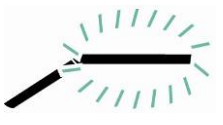





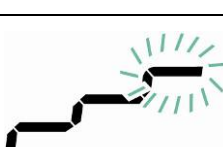

2.1 Overview of display



No.	Display	Description	
1	PROGRAM 0	Currently loaded drying program, see chap. 9.1	
2		Illuminates during communication with external devices.	
3		<ul style="list-style-type: none"> The stability display indicates that the weighing value is stable. Highlights current setting in the menu. 	
4		The indicator * will mark the measuring result	
5	Drying mode	Status display during drying	
	AUTO		Heating-up period
		Preset drying temperature is reached. The drying is finished when ΔM constant.	
	see chap. 9.2.1.1		
	TIME		Heating-up period
		Preset drying temperature is reached. The drying is finished when the preset drying time has expired.	

<p>RAPID</p>  <p>see chap. 9.2.1.3</p>		Heating-up period “pre-heating step”
		The pre-heating step is switched on until “ ΔM pre-heating step” is constant.
		Temperature is lowered to the preset drying temperature.
		Preset drying temperature is reached. The drying is finished when the preset completion criterion is fulfilled.
<p>SLOW</p>  <p>see chap. 9.2.1.4</p>		Heating-up period
		Preset drying temperature is reached. The drying is finished when the preset completion criterion is fulfilled.
<p>STEP</p>  <p>see chap. 9.2.1.5</p>		Heating-up period step 1
		Drying step 1
		Heating-up period step 2
		Drying step 2
		Heating-up period step 3
		Drying step 3

⑥	🕒 0:06:54	Previous drying time		
⑦	🌡️ 120°C	Current temperature		
⑧	M / W	Result display, see chap. 9.2.2		
		%	M/W	[%] moisture
			D/W	[%] dry mass:
			M/D	ATRO dry mass
			W/D	ATRO moisture
g	Gram	Gram display		
⑨	Basic displays			
	0.000g	Weight display		
	12.34%	Display % moisture		
	PRoGRAM	Menu access via MENU button		
	READY	Equipment is in Ready mode, see chap. 8.4.		
⑩	Current menu selection			
	UNIT	Equipment is in menu „Display of results“, see chap. 9.2.2		
	COMSET	Equipment is in menu „Interface parameters“, see chap. 11.2		
	CODE	Equipment is in menu „Sample denomination“, see chap. 10.1		
	CAL	Equipment is in menu „Adjustment“, see chap. 6		
	PRINT	Equipment is in menu „Printer“, see chap. 11.3 – 11.5		

	Status display „Equipment“		
	Top 	Is displayed when the heated cover is open.	
		Flashes when the heated cover needs to be closed.	
		Goes out when heated cover is closed	
	Centre 		Is displayed when the heated cover is open.
			Flashes when drying process is active
	Bottom 		Indicates that a sample is in the sample dish.
			Flashes when a sample needs to be loaded.
			Goes out if there is no sample in the sample dish.
			Indicates that a sample is in the sample dish.
			Flashes if taring is required.
			Goes out if no sample dish is in place.
	Indicates upon switch-on that the dish holder is installed.		
	Flashes upon switch-on if the dish holder is not installed.		

2.1.1 Display examples

During drying:

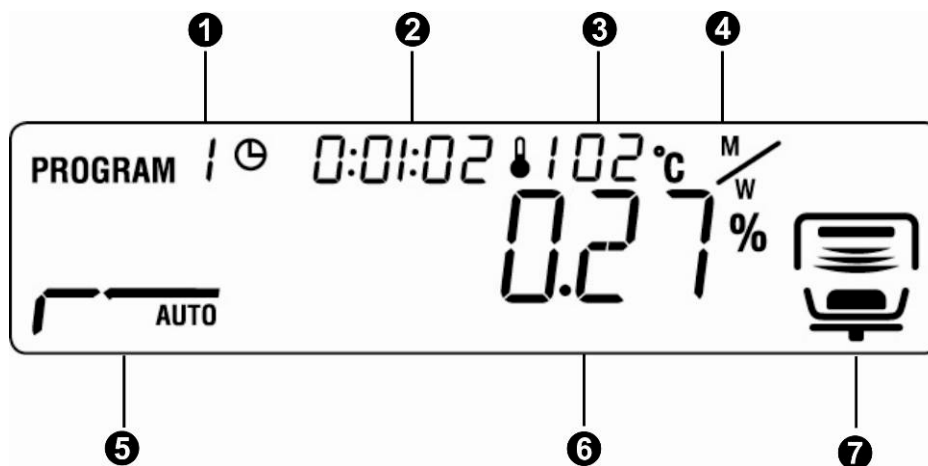



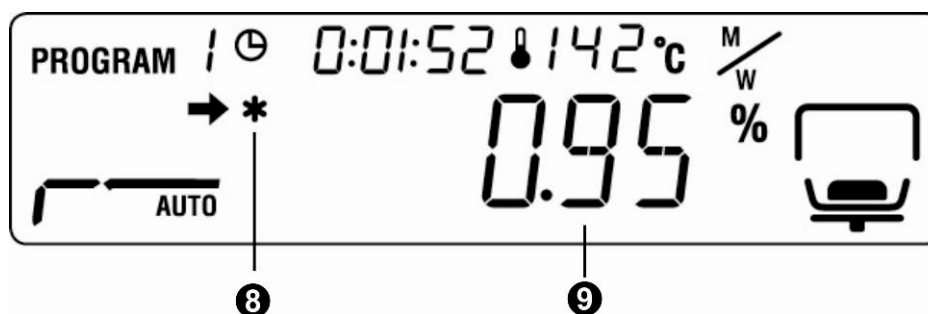



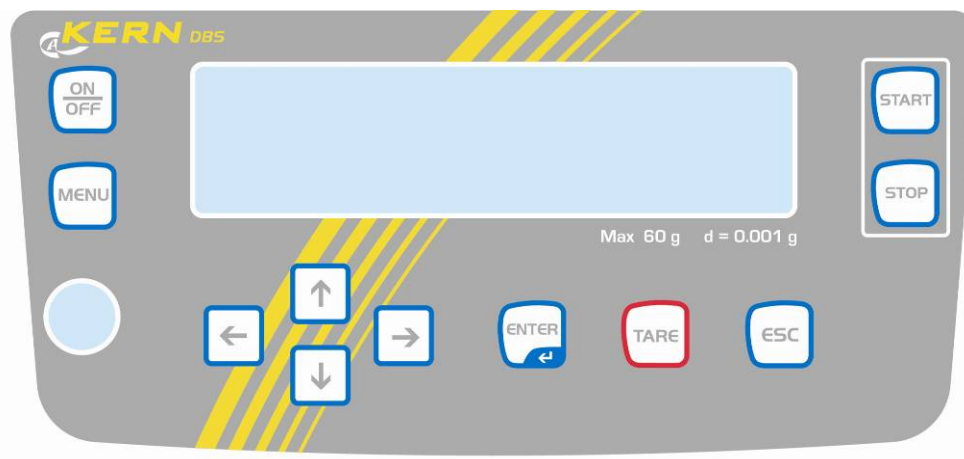

After drying:



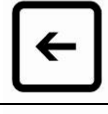

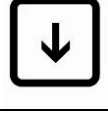
- ❶ Loaded drying program ☞ see chap 9.1
- ❷ Previous time
- ❸ Current temperature
- ❹ Unit „Display of results“ ☞ see chap. 9.2.2
- ❺ Preset drying mode /
Status display drying ☞ see chap. 9.2.1
☞ see chap. 2.1
- ❻ Current moisture content in %.
During drying with  can be switched in ΔM (see chap. 9.2.1.1).
- ❼ Drying process active ☞ see chap. 2.1
- ❽ Measuring result indicator
- ❾ Measuring value (unit in the preset result display) ☞ see chap. 9.2.2

2.2 Keyboard overview



	Turn on/off
	<ul style="list-style-type: none"> • Call up menu
	<ul style="list-style-type: none"> • Selecting a menu item to the left.
	<ul style="list-style-type: none"> • Scroll back
	<ul style="list-style-type: none"> • Scroll to next page
	<ul style="list-style-type: none"> • Selection of a menu item in clockwise direction
	<ul style="list-style-type: none"> • Taring • Zeroing
	<ul style="list-style-type: none"> • Activate menu item • Save setting

	<ul style="list-style-type: none">• Exit menu• Back to moisture analysis mode• Quit
	Start drying
	Complete drying

i Numerical input, see chap. 7.1.1

3 Basic Information (General)

3.1 Proper use

The device purchased by you is designed for a fast and reliable determination of material moisture in liquid, porous and solid materials by applying the method of thermogravimetrics.

3.2 Improper Use

Impacts and overloading exceeding the stated maximum load (max) of the device, minus a possibly existing tare load, must be strictly avoided.

Balance may be damaged by this.

Never operate device in explosive environment. The serial version is not explosion protected.

The structure of the balance may not be modified. This may lead to incorrect weighing results, safety-related faults and destruction of the moisture analyser.

The moisture analyser may only be used according to the described conditions. Other areas of use must be released by KERN in writing.

3.3 Warranty

Loss of warranty due to





- Our conditions in the operation manual are ignored
- The appliance is used outside the described uses
- The appliance is modified or opened
- mechanical damage and damage caused by media, liquids
- natural wear and tear
- The appliance is improperly set up or incorrectly electrically connected
- The measuring system is overloaded

3.4 Monitoring of Test Resources

In the framework of quality assurance the measuring-related properties of the moisture analyser and, if applicable, the testing weight, must be checked regularly. The responsible user must define a suitable interval as well as type and scope of this test. Information is available on KERN's home page (www.kern-sohn.com) with regard to the monitoring of balance test substances and the test weights required for this. In KERN's accredited DKD calibration laboratory test weights and balances may be calibrated (return to the national standard) fast and at moderate cost.

3.5 Danger Information

WARNING

-  The moisture analyser is used to analyse the moisture content of materials. This instrument must be used exclusively for this purpose. Any other usage may cause a risk to personnel, damage to the equipment or other material damage.
-  The moisture analyser should be used mainly for the drying of aqueous substances.
-  The moisture analyser may not be used in a hazardous area.
-  The appliance may only be operated and maintained by trained personnel.
-  Carefully read this operation manual before setup and commissioning, even if you are already familiar with KERN appliances.

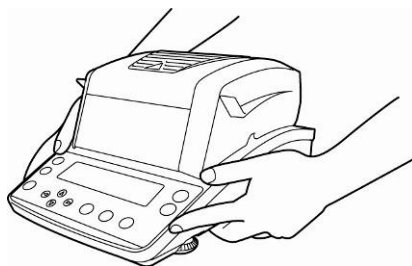

-  This moisture analyser is a robust precision instrument, however, it must be handled with care to ensure many years of trouble-free operation.



-  Never make any modifications or design changes to the equipment whatsoever. Always use original spare parts and accessories.



- ⚠** Make sure that liquids do not get in contact with the interior of the device, the connections at the rear of the device and the peripherals (connected PC or printer).
- If you spill liquid on the device, disconnect it immediately.
Afterwards do not operate the moisture analyzer and have it checked by a competent KERN stockist before any further use.



- ⚠** Never store materials on the equipment.

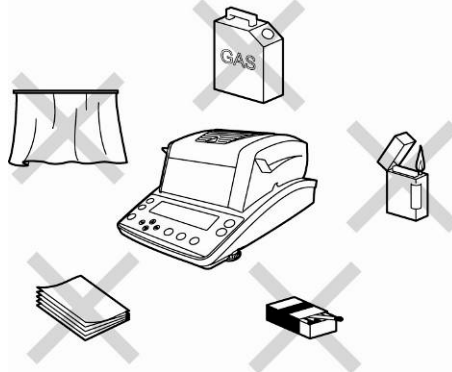

- ⚠** Never place combustible materials on, under or next to the equipment, as the environment of the instrument heats up to a high temperature.



- ⚠ Explosive, easily flammable samples and samples that go into a chemical reaction when subjected to heat, may not be analysed with the moisture analyser.
- ⚠ Sample materials emitting toxic substances must be dried with a special extraction system in place. Create an environment that prevents the inhalation of vapours hazardous to health.
- ⚠ Sample materials developing aggressive vapours (e. G. Acids) may cause corrosion problems on some parts of the device.

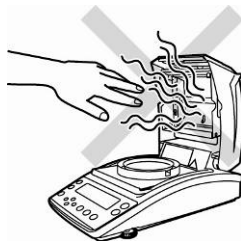

- ⚠ Careful when removing the sample. The sample itself, the sample dish and the heating unit may be very hot.
- ⚠ Maintain sufficient space in the environment of the equipment to prevent heat build-up (distance from the equipment 20cm, upwards 1m).
- ⚠ Do not operate the humidity analyser in areas with hazard of explosion
- ⚠ Do not place anything which may interfere the unplugging
- ⚠ The power plug must be easily accessible



Hazards during and after measuring

- ⚠️ Ensure correct installation of all components, see chap. 5.3
- ⚠️ Careful when removing the sample. The sample itself, the sample dish and the heating unit may be very hot.
- ⚠️ Use the sample retainer at all times as it allows safe working and prevents burns.

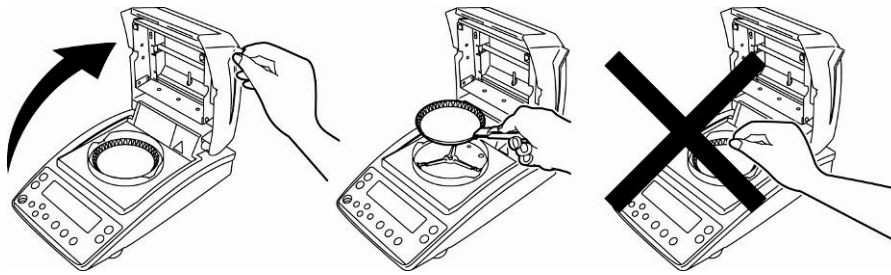

- ⚠️ Individual parts of the case (e. g. the ventilation grids) may heat up considerably during operation. Therefore, only take hold of the equipment by the marked handles.

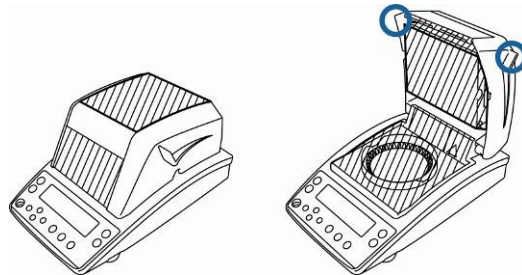

3.5.1 “Hazard information” sticker

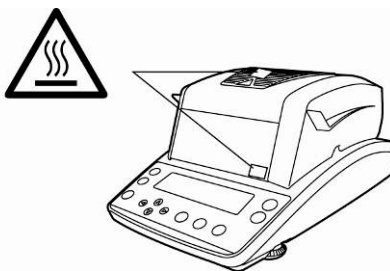

⚠ Ventilation grilles and inspection windows may become very hot during operation



⚠ Always open heated cover completely.

⚠ Do not use any combustible sample materials.

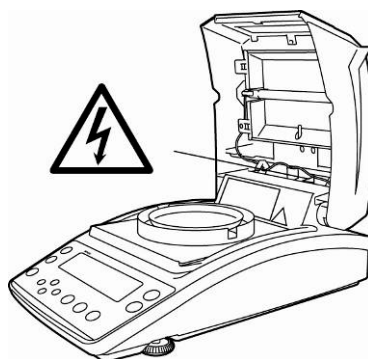

⚠ Disconnect the equipment from the power supply prior to changing a lamp, see chap. 13.2.2.

4 Transport and storage

4.1 Testing upon acceptance

When receiving the appliance, please check packaging immediately, and the appliance itself when unpacking for possible visible damage.

4.2 Packaging / return transport



- ⇒ Keep all parts of the original packaging for a possibly required return.
- ⇒ Only use original packaging for returning.
- ⇒ Prior to dispatch disconnect all cables and remove loose/mobile parts.
- ⇒ Reattach possibly supplied transport securing devices.
- ⇒ Secure all parts such as the glass wind screen, the weighing platform, power unit etc. against shifting and damage.

5 Unpacking, Setup and Commissioning

5.1 Installation Site, Location of Use

The unit is designed to achieve reliable weighing results under normal conditions of use.

You will work accurately and fast, if you select the right location for the appliance.

On the installation site observe the following:



⚠ Remove explosive materials from the immediate vicinity.
Emerging vapours, sample dish and all parts of the sample chamber are hot!

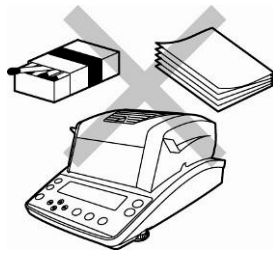

⚠ Remove easily flammable materials from the immediate vicinity.

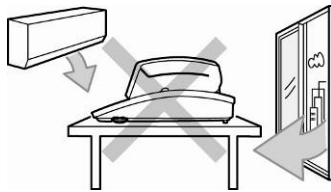

⚠ Protect the device against direct draughts due to open windows and doors.



⚠ Avoid extreme heat and temperature fluctuations e.g. due to installation next to radiators.



⚠ Avoid direct sunlight



⚠ Never store materials on the equipment.



- ⚠ Protect the appliance against high humidity, vapours and dust,
- ⚠ Major display deviations (incorrect weighing results) may be experienced should electromagnetic fields (e.g. due to mobile phones or radio equipment), static electricity accumulations or instable power supply occur. Change location or remove source of interference.
- ⚠ Avoid static charging of the material to be weighed, weighing container and windshield

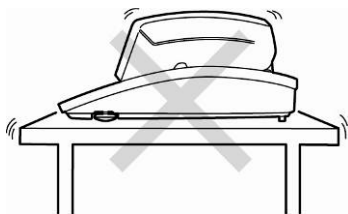

- ⚠ Place the device on a firm, level surface.
- ⚠ Avoid jarring during weighing.



- ⚠ Do not expose the device to extreme dampness for longer periods of time. Non-permitted condensation (condensation of air humidity on the appliance) may occur if a cold appliance is taken to a considerably warmer environment. In this case, acclimatize the disconnected appliance for ca. 2 hours at room temperature.

⚠ Operate the device only indoors.

5.2 Unpacking and checking

Open package, take out the appliance and accessories. Verify that there has been no damage and that all packing items are present.

5.2.1 Scope of delivery / serial accessories

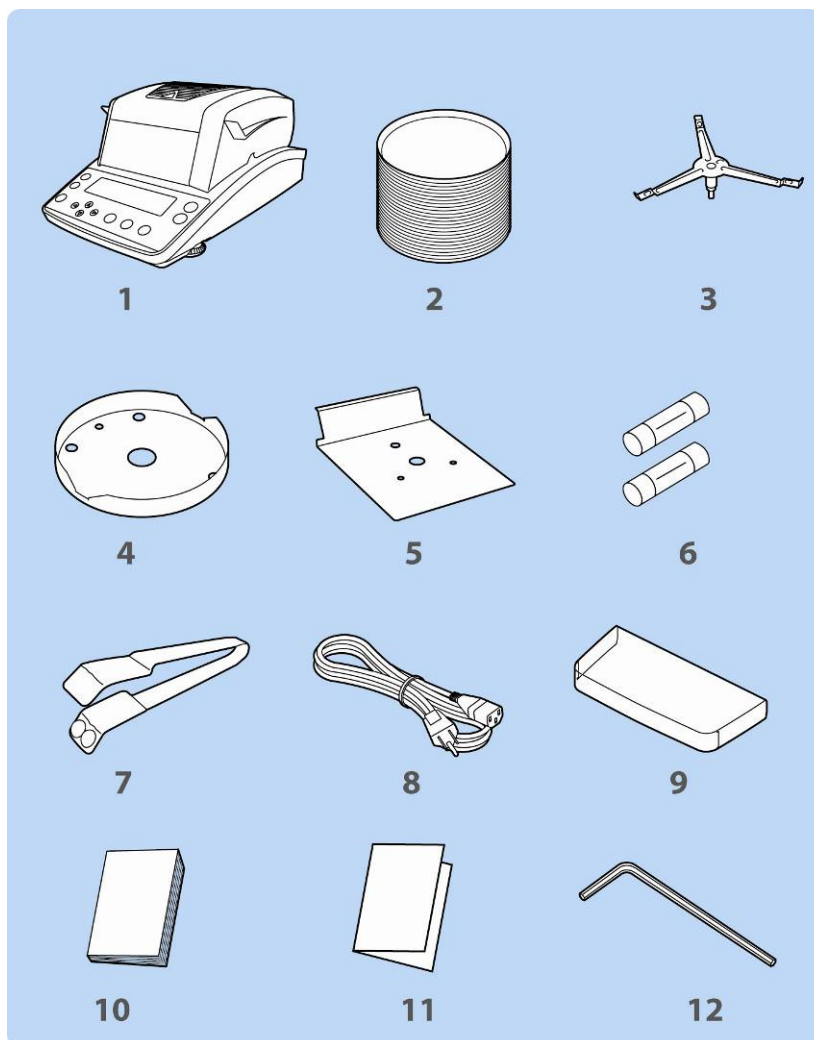

1. Instrument
2. 50 disposable sample dishes
3. Dish holder
4. Wind protection ring
5. Heat shield
6. Spare fuse
7. Removal aid
8. Power cable
9. Protective cover
10. Operating instructions
11. Menu overview
12. Hexagonal socket wrench

5.3 Placing

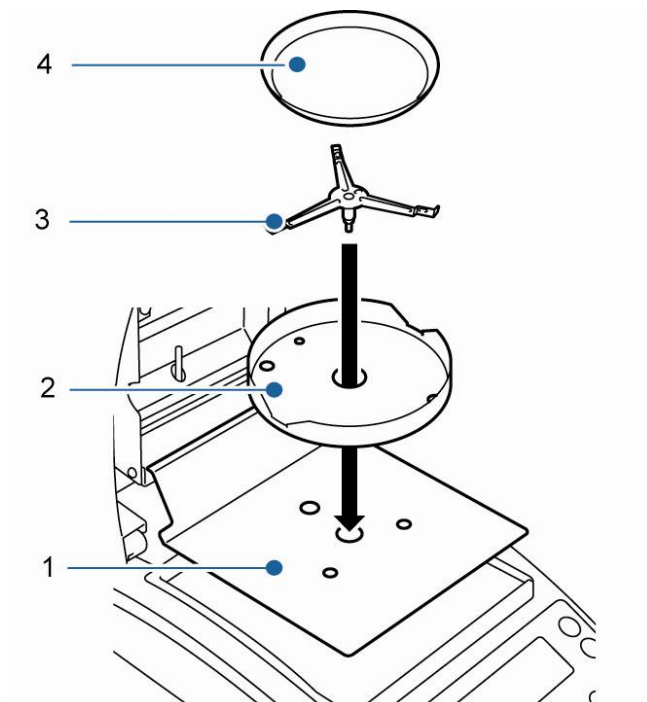

The moisture analyser is delivered in pieces. Check immediately after unpacking all the parts that the delivery is complete and assemble the individual components as described below.

1. Fit heat shield.

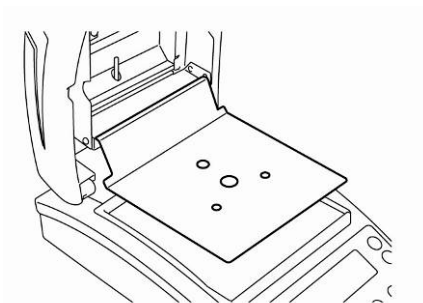

2. Install wind protection ring, ensuring correct positioning, ◆ on ◆.

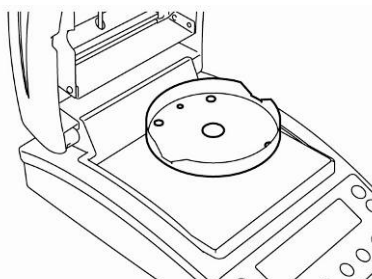

- 3. Install dish holder, ensuring correct positioning, ◆ on ◆.

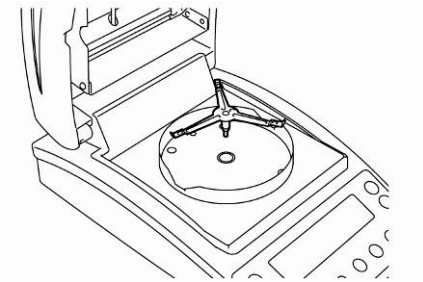

- 4. Fit sample dish.

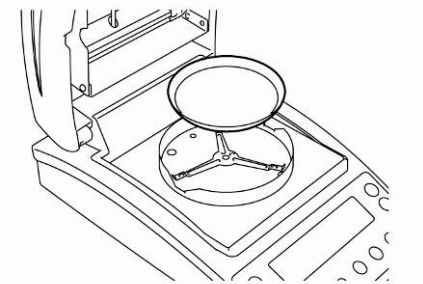

- 5. Level the equipment with foot screws [1] until the air bubble of the water balance is in the prescribed circle.

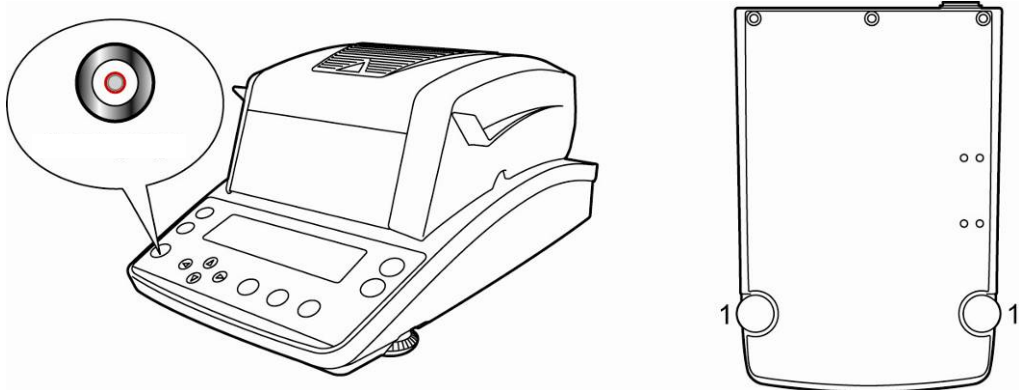

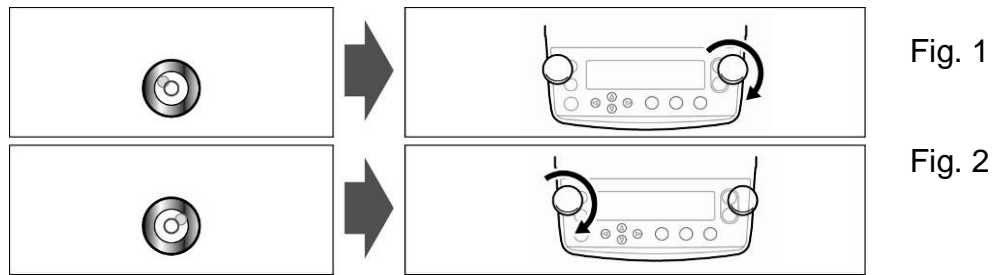

Fig. 1

Fig. 2

If the air bubble is at the lefthand edge, level the equipment with the righthand foot screw, see Fig.1.

If the air bubble is at the righthand edge, level the equipment with the lefthand foot screw, see Fig.2.

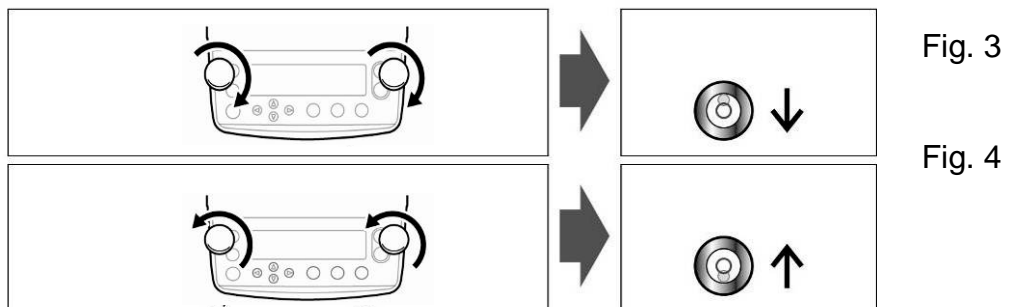

Fig. 3

Fig. 4

If both foot screws are turned simultaneously in clockwise direction, the air bubble will move forwards (see Fig.3).

If both foot screws are turned simultaneously in anticlockwise direction, the air bubble will move backwards (see Fig.4).

i Check levelling regularly.

5.4 Mains connection

Power supply is provided via the supplied mains cable.

Check, whether the voltage acceptance on the scales is set correctly. Do not connect the appliance to the power grid unless the information on the appliance (sticker) matches the local mains voltage.

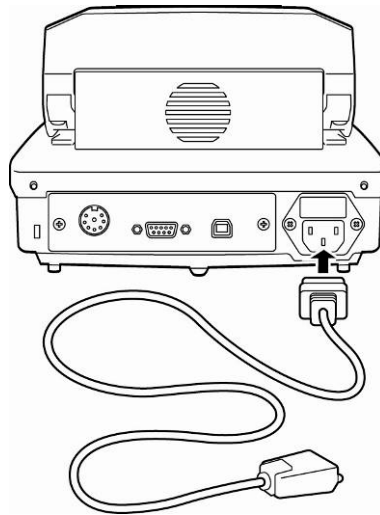

Important:

Does the labelling match the local mains voltage?

- Do not connect if mains voltages are different!
- If matching, connect the scales.

The moisture analyzer must be connected to a standard socket with earth terminal. Do not eliminate the protective effect by using an extension lead without earth terminal. For power supplies from power grids without earth terminals call a specialist to establish equivalent protection according to the relevant installation regulations.

- The power plug must be always accessible.
- Before operating, check all cables for damage.
- Guide the cables so that they cannot become damaged or interfere with the measuring process.

5.4.1 Turning On the Power

- ⇒ Supply balance with power via the mains power cable. The display lights up and the equipment conducts a self-test.



- ⇒ The selftest is completed when „OFF“ appears on the display.
- ⇒ To switch on press the **ON/OFF** button. The equipment conducts a segment test. As soon as the weight display appears, the instrument will be ready to weigh.

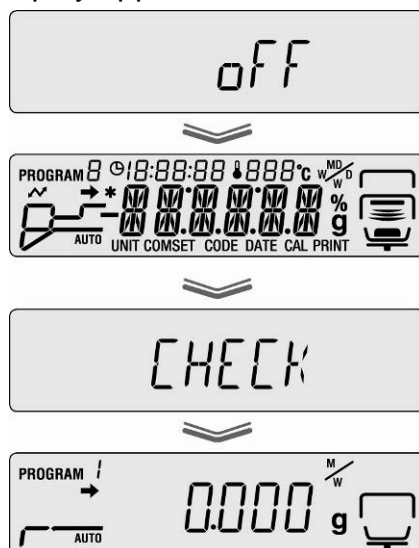

5.5 Commissioning

In order to obtain exact results, the appliance must have reached its operating temperature (see warm-up time chap. 1).

For this warm-up time the appliance must be connected to the power supply.

The accuracy of the appliance depends on the local acceleration of gravity.

Strictly observe hints in chapter Adjustment.

5.6 Connection of peripheral devices

Before connecting or disconnecting of additional devices (printer, PC) to the data interface, always disconnect the moisture analyser from the power supply.

Only use accessories and peripheral devices by KERN, as they are ideally tuned to the appliance.

6 Adjustment

6.1 Adjust balance

As the acceleration value due to gravity is not the same at every location on earth, each balance must be coordinated - in compliance with the underlying physical weighing principle - to the existing acceleration due to gravity at its place of location (only if the balance has not already been adjusted to the location in the factory). This adjustment process must be carried out for the first commissioning, after each change of location as well as in case of fluctuating environment temperature. To receive accurate measuring values it is also recommended to adjust the balance periodically in weighing operation.

- i**
- Observe stable environmental conditions. A warming up time (see chapter 1) is required for stabilization.
 - Carry out adjustment with placed sample dish. Ensure that no objects are within the sample dish.
 - Carry out adjustment as near as possible to the balance's maximum weight (recommended adjustment weight see chap. 1). Weights of different nominal values (10g – 60g) may be used for adjustment but are not optimal for technical measuring. Info about test weights can be found on the Internet at: <http://www.kern-sohn.com>

⇒ Press the **Menu** button to access the menu.



⇒ Use navigation buttons **↓** **↑** to select menu item **"CAL"**.



⇒ Acknowledge using **ENTER** key, the current setting is displayed. If necessary, use navigation buttons **↓** **↑** to select **"BAL"**.



⇒ Press **ENTER** to confirm and **"WAIT"** will be displayed followed by the currently preset adjustment weight.



Open heated cover

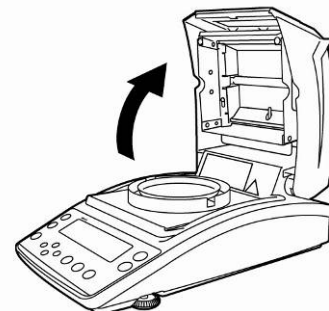

- i** • If the value of the adjustment weight needs to be changed, use the navigation buttons to make the required setting (see chap. 7.1.1. “Numerical input”).
- The adjustment protocol output is started upon connection to an optional printer and activated GLP function (see chap. 6.3).

⇒ When the adjustment weight display flashes, e.g. 50g, place it carefully in the centre of the sample dish.

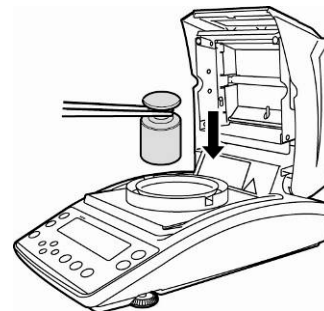

⇒ Adjustment starts.

⇒ Wait until „0.000g“ appears. Remove the adjustment weight during the flashing display.



⇒ The adjustment is completed when “END” is displayed. The device returns to the menu automatically.



⇒ Press **ESC** to return to weighing mode.



6.2 Adjust temperature

We recommend sometimes to check the temperature value of the device using the optional temperature calibrating set DBS-A01. The temperature is measured at two points (100°C and 180°C) and can be adjusted at these two points.

The equipment should cool down first to room temperature after the last heating period.

Preparation:

- ⇒ Fix the temperature sensor on the temperature calibration set in accordance with the illustration.
- ⇒ Remove sample dish and dish holder from the moisture analyser.
- ⇒ Install the temperature-calibration set acc. to fig.
- ⇒ Close heated cover.
If applicable, the error message "ol" will be displayed, but can be ignored in this case.
- ⇒ On the temperature calibration set switch-on the digital thermometer by the **ON/OFF** button.

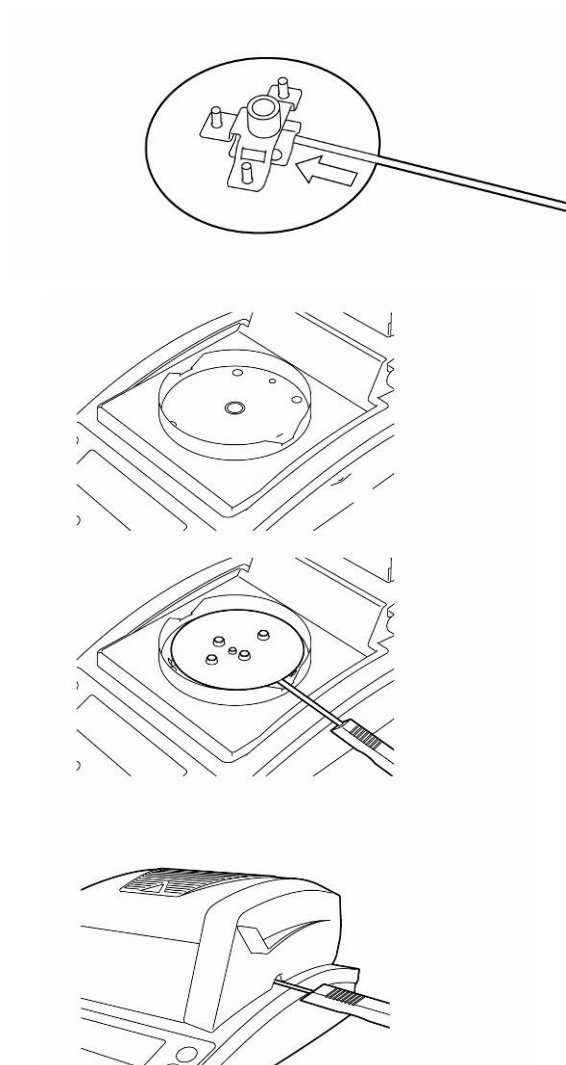

Call up menu:

⇒ Press the **Menu** button to access the menu and the first menu item “**PRoGRM**” will be displayed.



⇒ Use navigation buttons **↓** **↑** to select menu item “**CAL**”.

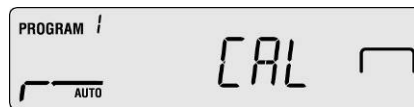

⇒ Acknowledge using **ENTER** key, the current setting is displayed. If necessary, use navigation buttons **↓** **↑** to select “**TEMP**”.



⇒ Press **ENTER** to confirm and the first temperature point to be tested will be displayed.



⇒ Press **START** and the first heating-up period will start.



- i** • Do not leave the heated cover open for more than 1 minute during the heating-up period, otherwise the error message “**ERR.100**” will appear. In this case press **ESC** and restart menu item “**TEMP**”.
- Attention: some parts e.g. ventilation grilles and inspection windows may become very hot during operation.
- The adjustment must be made within 15 minutes when the temperature display flashes, otherwise the temperature adjustment will be aborted (ABORT will be displayed).

⇒ Temperature calibration for the first point takes 15 min. Compare the displayed temperature value on the thermometer with that of the moisture analyser whilst the temperature display is flashing. If the two values do not match, correct them using the navigation buttons **↓** **↑** and confirm with the **ENTER** button Numerical input, see chap. 7.1.1.



- ⇒ The second temperature point to be tested will be displayed.
- ⇒ Confirm with the **ENTER** button, the second heat-up phase is started.
- ⇒ Temperature calibration for the second point takes 15 min. Compare the displayed temperature value on the thermometer with that of the moisture analyser whilst the temperature display is flashing. If the two values do not match, correct them using the navigation buttons **↓** **↑** and confirm with the **ENTER** button Numerical input, see chap. 7.1.1.
- ⇒ The adjustment is completed when “END” is displayed. The device returns to the menu automatically.
The adjustment protocol output is started upon connection to an optional printer and activated GLP function (see chap. 6.3).
- ⇒ Press **ESC** to return to Moisture analysis mode.



⇒



⇒



⇒

- i** • The adjustment protocol output is started upon connection to an optional printer and activated GLP function (see chap. 6.3).

6.3 ISO/GLP log

Quality assurance systems require printouts of measuring results as well as of correct adjustment stating date and time and equipment identification. The easiest way is to have a printer connected.

- i** • Ensure that the communication parameters for moisture analyser and printer concur, see chap. 11.2.
- For printout sample see chapter 11.7

⇒ Press the **Menu** button to access the menu and the first menu item **“PRoGRM”** will be displayed.



⇒ Use navigation buttons **↓ ↑** to select menu item **“CAL”**.



⇒ Press **ENTER** to confirm and the current Adjustment mode **“BAL / TEMP”** will be displayed.

⇒ Use navigation buttons **↓ ↑** to select **“CAL.REC”**.



⇒ Press **ENTER** to confirm and the indicator **➔** next to **“CAL.REC”** will display the current setting.

Indicator ➔	Display	Selection
is displayed		Adjustment protocol output activated
is not displayed		Adjustment protocol output de-activated

⇒ Press **ENTER** to activate/de-activate this function.





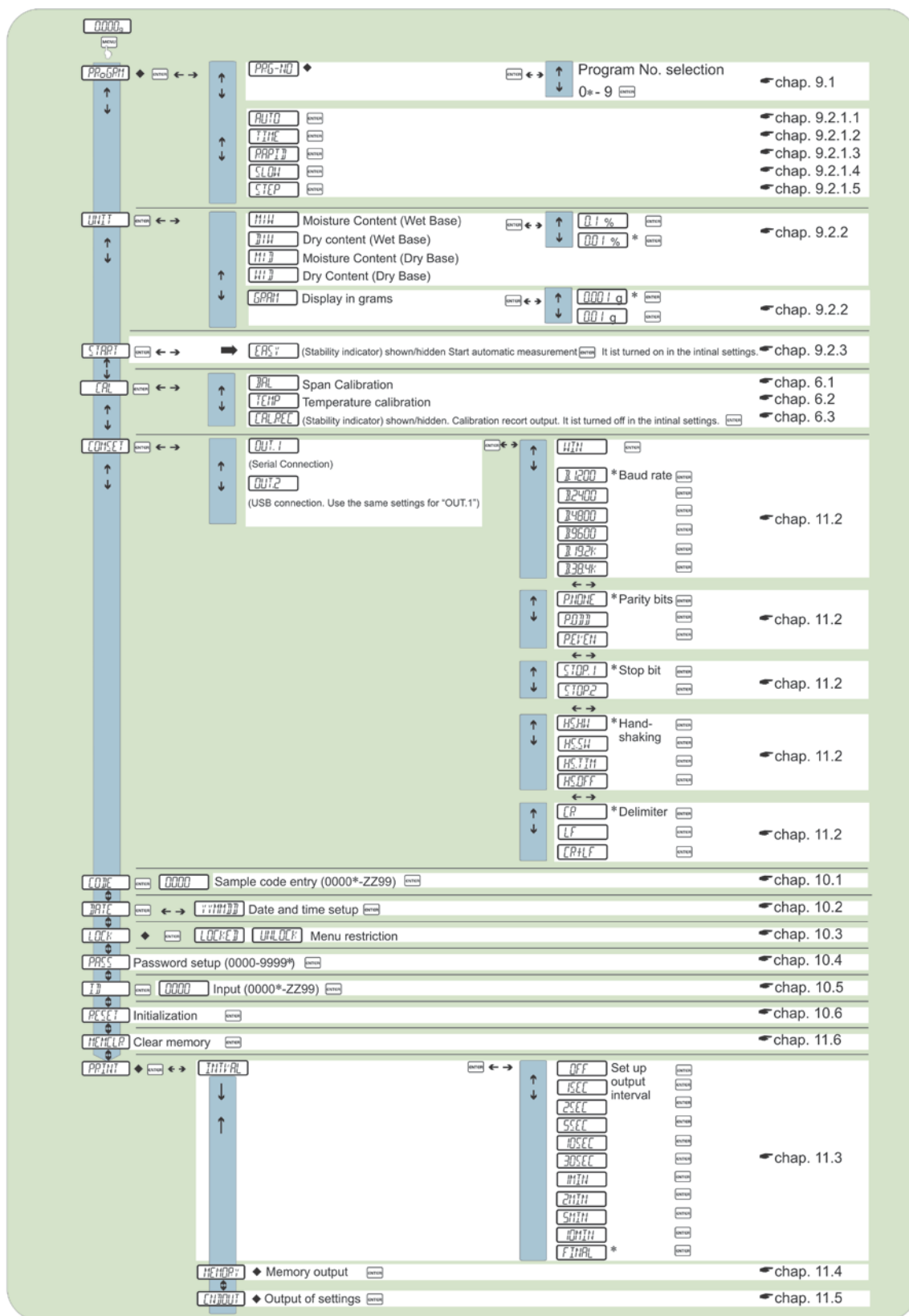

⇒ Press **ESC** to return to Moisture analysis mode.

7 Menu Menu Map









↑ ↓	Press ↑ or ↓ to search for the menu option	*	Default settings
↔	Press → to proceed to the next menu option. Press ← to return to the previous menu option.	◆	Indicates the restriction of menu item selection
☑	Confirm	☞	Refers to a chapter in the instruction manual

7.1 Navigation in the menu

	<ul style="list-style-type: none">• Call up menu
	<ul style="list-style-type: none">• Select and scroll up through the menu items• Select setting within one function
	<ul style="list-style-type: none">• Select and scroll down through the menu items• Select setting within one function
	<ul style="list-style-type: none">• Selecting a menu item to the left
	<ul style="list-style-type: none">• Selection of a menu item in clockwise direction
	<ul style="list-style-type: none">• Confirm and save
	<ul style="list-style-type: none">• Exit menu

7.1.1 Numeric entry

Key	Description	Function
	Navigation key ↑	Increase flashing digit
	Navigation key ↓	Decrease flashing digit
	Navigation key →	Digit selection to the right
	Navigation key ←	Digit selection to the left
	ENTER -key	Confirm entry
	ESC -key	Cancel input

8 Moisture analysis

8.1 Start drying

i First set the drying parameters as described in chap. 9 during initial start-up.

⇒ Or set the drying parameters as described in chap. 9 or load from store a suitable drying program for the sample, see chap. 9.1.

Ensure that the equipment is in Moisture analysis mode. Press **ESC** if necessary.



⇒ Open heated cover

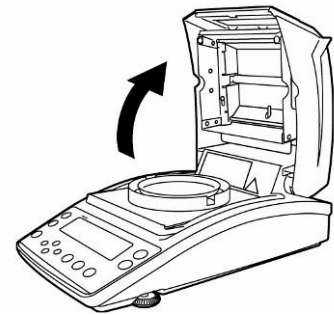

⇒ Deposit a sample dish acclimatised to room temperature.

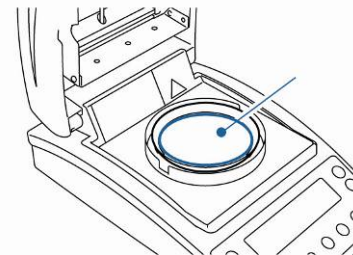

⇒ When the heated cover is closed, wait for the stability display [→] and press the **TARE** button to reset to zero.



i Load sample within 30 minutes otherwise the message “TIM.oUT” will be displayed. In this case, press **ESC** and reset to zero.

⇒ Place sample in sample dish.
Sample preparation see chap. 12.4
Ensure minimum initial weight > 0.02 g

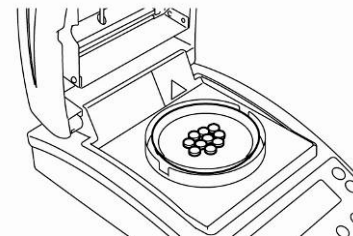

⇒ Close heated cover and measuring will start automatically.

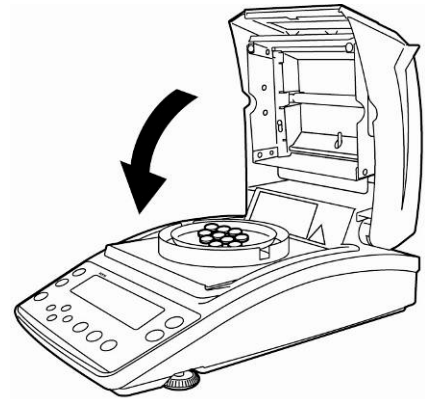

- If measuring does not start automatically, the equipment is preset for Manual start. Press the **START** button to start.
- Manual or Automatic start can be selected in the menu, see chap. 9.2.3
- Observe hazard information, see Chapter 3.5 “Hazards during and after measuring”

- ⇒ When drying is finished, you will hear an acoustic signal and the heating will be shut off.
- ⇒ The measuring result, marked by the indicator [*], will be displayed.
- ⇒ The blower will switch off automatically after a short time.
- ⇒ Press the **ON/OFF** button for further measurements and the equipment will revert to Moisture analysis mode. The indicator [*] will go out.
- ⇒ Finish drying, see chap. 8.3



- When an optional printer is connected, the measurement log will be edited independently on the settings in the menu, see chap. 11.3

8.2 Abort drying

- ⇒ The measuring can be aborted at any time by pressing the **STOP** button. A long signal will sound, and “**ABORT**” will be displayed.

Either

- ⇒ Press **ESC** key. The equipment reverts to Moisture analysis mode and the measuring result is discarded.

or

- ⇒ Press **STOP** key again. The measuring result, marked by the indicator [*], will be displayed and saved.



8.3 Finish drying

- ⇒ Open heated cover

- ⚠ Observe hazard information, see Chapter 3.5 “Hazards during and after measuring”
- ⚠ Careful when removing the sample. The sample itself, the sample dish and the heating unit may be very hot.
- ⚠ Always work with a removal aid as this will enable safe working and prevent burns.



If you will repeat measurement for the same sample

- ⇒ Press **START** key to measure the same sample after the measurement successively. If you switch the mode to manual start, you can measure successively after resetting the measurement result.

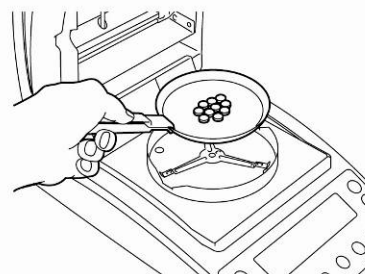
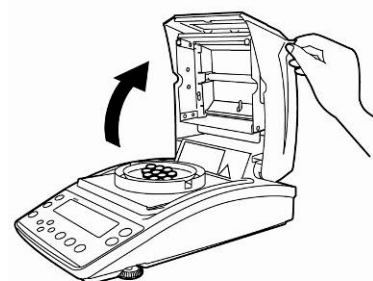

8.4 Turn off appliance

- ⇒ Press **ON/OFF** button until “**OFF**” appears and the display will change to “**READY**”. The equipment migrates to Ready mode. The moisture analyser does not require any warm-up time in Ready mode in order to be used for measuring.
- ⇒ The equipment must be disconnected from the mains in order to switch the power supply off completely.





9 Drying parameters

The equipment can be used to store complete drying programs with drying parameters individually adapted to the sample.

Four drying modes (Standard drying, Step drying, Slow drying and Rapid drying) and two switch-off criteria (Time-controlled and Automatic) can be selected.

Further parameters such as drying time, drying temperature and ΔM (constant weight loss per 30 seconds) should be set depending on the modes, see table below.

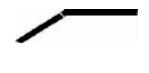
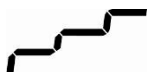
	Display	Drying mode	Switch-off criterion	Drying time	Drying temperature	ΔM
AUTO ☞ see chap. 9.2.1.1		Standard	Automatic	-	x	x
TIME ☞ see chap. 9.2.1.2		Standard	Time-controlled	x	x	-
RAPID ☞ see chap. 9.2.1.3	RAPID 	Fast drying	Time-controlled	x	x	-
			or	Automatic	-	x
SLOW ☞ see chap. 9.2.1.4	SLOW 	Slow drying	Time-controlled	x	x	-
			or	Automatic	-	x
STEP ☞ see chap. 9.2.1.5	STEP 	Step drying	Time-controlled	x	x	-
			or	Automatic	-	x

Select memory location for the drying program prior to selecting the drying parameters, see chap. 9.1.

i Do not exceed the operating time of 1 hour to protect the equipment at drying temperatures above 180°C.

9.1 Save / access

10 memory locations, which can be simply called up and started as necessary under the saved Program number, are available for complete drying processes.

- ⇒ Press the **Menu** button to access the menu and the first menu item “PRoGRM” will be displayed.



- ⇒ Use navigation button → and confirm by pressing **ENTER**.

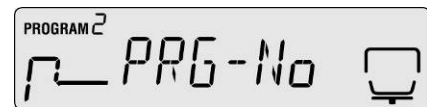

The current setting will be displayed.



- ⇒ Use navigation buttons ↓ ↑ to select the required Program Number, Nos.0 – 9 can be selected.



- ⇒ Press **ENTER** to confirm selection. [5 1:xxx] displays the currently preset drying parameters.
- ⇒ Press **ESC** to return to Moisture analysis mode.
- ⇒ Set the drying parameters under the selected program number, see chap. 9.2 below.



9.2 Adjust

9.2.1 Drying modes

9.2.1.1 Drying mode AUTO

(Standard drying/switch-off criterion “ ΔM “)

Drying will be carried out at the drying temperature preset by the user.

The drying is finished automatically when the preset weight loss (ΔM) remains constant for 30 seconds.

SETTINGS:

- Drying mode **AUTO** 
 - Drying temperature 
 - ΔM 
- ⇒ Press the **Menu** button to access the menu and the first menu item “**PRoGRM**” will be displayed.

- ⇒ Press navigation button **→**, then use navigation buttons **↓** **↑** to select “**AUTO**”.

- ⇒ Press **ENTER** to confirm and the currently preset drying temperature will flash in the display.

- ⇒ Use navigation buttons **↓** **↑** to select the required setting, 50°C – 200°C (1°C increments) can be selected.

- ⇒ Press **ENTER** to confirm selection. The currently preset value for ΔM will be displayed.

- ⇒ Use navigation buttons **↓** **↑** to select the required setting, 0.01% – 0.1% (0.01% increments) can be selected.

- ⇒ Press **ENTER** to save.

- ⇒ Press **ESC** to return to Moisture analysis mode. The measuring can be started (see chap. 8.1). All the settings that have been made control the drying process.



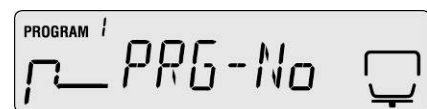

The switch-off criterion has been fulfilled with a sample whose moisture content is below 0.01%. In this case, we recommend selecting the drying program **TIME** described below, see chap. 9.2.1.2



9.2.1.2 Drying mode TIME (Standard drying/switch-off criterion “Time“)

The drying will be carried out at the drying temperature preset by the user and will end automatically when the preset time has expired.

SETTINGS:

- Drying mode **TIME** 
- Drying temperature 
- Drying time 

⇒ Press the **Menu** button to access the menu and the first menu item “PRoGRM” will be displayed.



⇒ Press navigation button →, then use navigation buttons ↓ ↑ to select “TIME”.



⇒ Press **ENTER** to confirm and the currently preset drying temperature will flash in the display.



⇒ Use navigation buttons ↓ ↑ to select the required setting, 50°C – 200°C (1°C increments) can be selected.

⇒ Press **ENTER** to confirm selection. The currently set drying time is displayed.



⇒ Use navigation buttons ↓ ↑ to select the required setting, 1 minute – 4 hours (1 minute increments) or 4 hours - 12 hours (1 hour increments) can be selected

⇒ Press **ENTER** to save.



⇒ Press **ESC** to return to Moisture analysis mode. The equipment is ready to measure (see chap. 8.1). All the settings that have been made control the drying process.



9.2.1.3 RAPID Drying mode (Rapid drying)

A preheating step is switched on for Rapid drying, i.e. the temperature will increase very quickly and will exceed the preset drying temperature until it falls below the preset reference value (weight loss/30 sec).

After that the temperature will be adjusted down to the set value. The drying will end depending on the setting, when the preset time has expired or the preset weight loss (ΔM) remains constant for 30 seconds.

Rapid drying is suitable for samples with high moisture content (e.g. liquids).

Settings:

- **RAPID** Drying mode
- ΔM "pre-heating step"
- Drying temperature
- Drying time switch-off criterion or ΔM



⇒ Press the **Menu** button to access the menu and the first menu item "PRoGRM" will be displayed.



⇒ Press navigation button **→**, then use navigation buttons **↓** **↑** to select "**RAPID**".

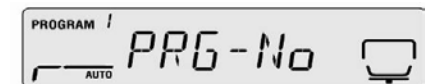

⇒ Press **ENTER** to confirm and the currently preset reference value for the preheating step will flash in the display.

0.1% -9.9% (0.01% increments) can be selected



⇒ Press **ENTER** to confirm and the currently preset drying temperature will flash in the display.

⇒ Use navigation buttons **↓** **↑** to select the required setting, 50°C – 200°C (1°C increments) can be selected.



- ⇒ Press **ENTER** to confirm selection. The currently present switch-off criterion will be displayed.
- ⇒ Use navigation buttons **↓** **↑** to select the required setting,
TIME = time-controlled
ΔM = automatic

TIME setting

- ⇒ Press **ENTER** to confirm selection. The currently set drying time is displayed.
- ⇒ Use navigation buttons **↓** **↑** to select the required setting, 1 minute – 4 hours (1 minute increments) or 4 hours - 12 hours (1 hour increments) can be selected
- ⇒ Press **ENTER** to save.

- ⇒ Press **ESC** key to return to weighing mode. The moisture analysis can be started (see chap. 8.2). All the settings that have been made control the drying process.

or

Setting ΔM

- ⇒ Press **ENTER** to confirm selection. The currently preset value for ΔM will be displayed.
- ⇒ Use navigation buttons **↓** **↑** to select the required setting, 0.01% – 0.1% (0.01% increments) can be selected.

- ⇒ Press **ENTER** to save.

- ⇒ Press **ESC** to return to Moisture analysis mode. The equipment is ready to measure (see chap. 8.1). All the settings that have been made control the drying process.

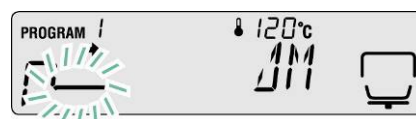
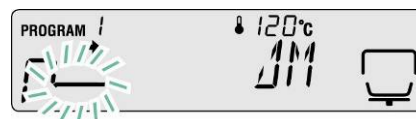

9.2.1.4 SLOW Drying mode (Slow drying)

The Slow drying temperature is increased more slowly to the preset value than for Standard drying.

The drying will end depending on the setting, when the preset time has expired or the preset weight loss (ΔM) remains constant for 30 seconds.

Slow drying is suitable for samples that cannot tolerate rapid heating by the heaters. The same applies to samples that form a skin during rapid heating. This skin will then affect the evaporation of the trapped moisture.

Settings:

- **SLOW** Drying mode
- Drying temperature
- Drying time switch-off criterion or ΔM



⇒ Press the **Menu** button to access the menu and the first menu item “PRoGRM” will be displayed.



⇒ Press navigation button →, then use navigation buttons ↓ ↑ to select “SLOW”.

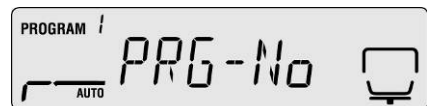

⇒ Press **ENTER** to confirm and the currently preset drying temperature will flash in the display.



⇒ Use navigation buttons ↓ ↑ to select the required setting, 50°C – 200°C (1°C increments) can be selected.

- ⇒ Press **ENTER** to confirm selection. The currently present switch-off criterion will be displayed.
- ⇒ Use navigation buttons **↓** **↑** to select the required setting,
TIME = time-controlled
 ΔM = automatic

TIME setting

- ⇒ Press **ENTER** to confirm selection. The currently set drying time is displayed.
- ⇒ Use navigation buttons **↓** **↑** to select the required setting, 1 minute – 4 hours (1 minute increments) or 4 hours - 12 hours (1 hour increments) can be selected
- ⇒ Press **ENTER** to save.

- ⇒ Press **ESC** key to return to weighing mode. The moisture analysis can be started (see chap. 8.2). All the settings that have been made control the drying process.

or

Setting ΔM

- ⇒ Press **ENTER** to confirm selection. The currently preset value for ΔM will be displayed.
- ⇒ Use navigation buttons **↓** **↑** to select the required setting, 0.01% – 0.1% (0.01% increments) can be selected.

- ⇒ Press **ENTER** to save.

- ⇒ Press **ESC** to return to Moisture analysis mode. The equipment is ready to measure (see chap. 8.1). All the settings that have been made control the drying process.

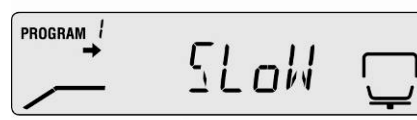
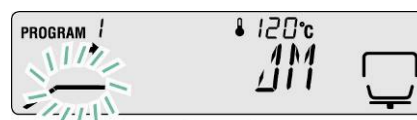
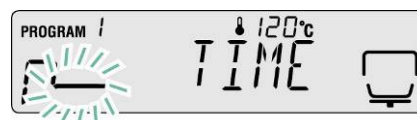
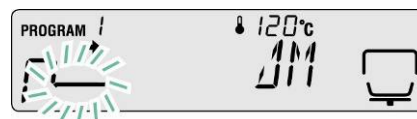







9.2.1.5 STEP Drying mode (Step drying)

Step-by-step drying is suitable for substances that display special behaviour during warming. 2 or 3 steps can be selected.

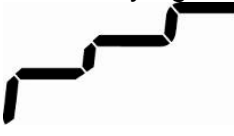
The individual steps are freely selectable regards duration and temperature rising step.

The drying will end depending on the setting for step 2 or 3, when the preset time has expired or the preset weight loss (ΔM) remains constant for 30 seconds.

Settings:

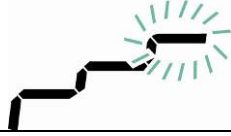
	1. Level	2. Level	3. Level
STEP Drying mode 	Drying temperature 	Drying temperature 	Drying temperature 
Switch-off criterion	Drying time 	Drying time 	Drying time 
	-	or ΔM	or ΔM

1. Press the Menu button to access the menu.



2. Select drying mode

- ⇒ Press navigation button →, then use navigation buttons ↓ ↑ to select "STEP".



3. Set drying temperature for step 1

- ⇒ Press **ENTER** to confirm and the currently preset drying temperature for step 1 will flash in the display.
- ⇒ Use navigation buttons ↓ ↑ to select the required setting, 50°C – 200°C (1°C increments) can be selected.



4. Preset drying time for step 1

- ⇒ Press **ENTER** to confirm. The currently preset drying time for step 1 will be displayed.
- ⇒ Use navigation buttons **↓** **↑** to select the required setting, 1 minute – 4 hours (1 minute increments) can be selected



5. Set drying temperature for step 2

- ⇒ Press **ENTER** to confirm and the currently preset drying temperature for step 2 will flash in the display.
- ⇒ Use navigation buttons **↓** **↑** to select the required setting, 50°C – 200°C (1°C increments) can be selected.



6. Set drying time or ΔM for step 2

- ⇒ Acknowledge using **ENTER** key, the current setting is displayed.
- ⇒ Use navigation buttons **↓** **↑** to select switch-off criterion (TIME or ΔM) for step 2.

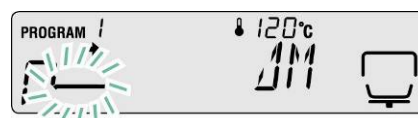

Setting ΔM

- ⇒ Press **ENTER** to confirm selection. The currently preset value for ΔM will be displayed.
- ⇒ Use navigation buttons **↓** **↑** to select the required setting, 0.01% – 0.1% (0.01% increments) can be selected.

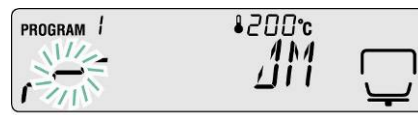

or

TIME setting

- ⇒ Press **ENTER** to confirm selection. The currently set drying time is displayed.
- ⇒ Use navigation buttons **↓** **↑** to select the required setting, 0 minutes – 240 minutes (1 minute increments) can be selected
If 0 minutes are entered, the next step will be cancelled.
- ⇒ Press **ENTER** to confirm.



Continue from step 8 for 2-step drying.

Continue from step 7 for 3-step drying.

7. Set drying parameters for step 3.

For drying temperature input, see step 5.

For drying time input or ΔM see step 6

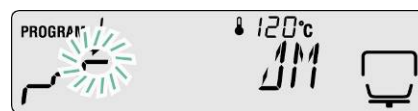

8. Return to weighing mode

- ⇒ Press **ESC** to return to Moisture analysis mode. The equipment is ready to measure (see chap. 8.1). All the settings that have been made control the drying process.



9.2.2 Result display

The result display enables the selection of a display in % moisture, % dry mass, ATRO* dry mass, ATRO* moisture and residual weight in grams.





Calculation:

Explanation of symbols

W: Starting weight (weight at start of measuring)

D: Residual weight (weight value at the end of measurement)

M: Weight loss = starting weight – residual weight

Unit	Calculation	Display
[%] moisture 0 – 100%	$\frac{W - D}{W} = 100\%$	
[%] dry mass 100 – 0%	$\frac{D}{W} \times 100\%$	
ATRO* dry mass 100 – 999%	$\frac{W - D}{D} \times 100\%$	
ATRO* moisture: 0 – 999%	$\frac{W}{D} \times 100\%$	



*ATRO is a unit which is exclusively used in the timber industry.

The timber humidity (ATRO) means the percentage of water contained in the timber, indicated in percent of the mass of the water-free timber.

It is calculated from the difference between fresh weight (SG) and dry weight (RG).

Menu settings:

⇒ Press the **Menu** button to access the menu and the first menu item “PRoGRM” will be displayed.



- ⇒ Use the navigation key **↓** **↑** to select menu item „UNIT“.
- ⇒ Acknowledge using **ENTER** key, the current setting is displayed.
- ⇒ Select the desired unit using the navigation keys (**↓** **↑**).



Display	Description
[M/W]	[%] moisture
[D/W]	[%] dry mass:
[M/D]	ATRO* dry mass
[W/D]	ATRO* moisture
[GRAM]	Gram display



- ⇒ Press **ENTER** to confirm selection. The currently preset value for the minimum reading will be displayed.
- ⇒ Select the desired position using the navigation keys **↓** **↑**.

Unit	Options:
[M/W] [D/W] [M/D] [W/D]	[0.1%] or [0.01%]
[GRAM]	[0.001g] or [0.01g]



- ⇒ Press **ENTER** to confirm selection.
- ⇒ Press **ESC** to return to Moisture analysis mode.

9.2.3 Start criterion

The menu item “**START**” enables the selection of Manual and Automatic start of a measurement.

⇒ Press the **Menu** button to access the menu and the first menu item “PRoGRM” will be displayed.





⇒ Use the navigation keys ↓ ↑ to select the menu item „**START**“.

⇒ Press **ENTER** to confirm and the indicator ➔ next to “**EASY**” will display the current setting.



⇒ Use the **ENTER** button to switch between Manual and Automatic start.



Indicator ➔	Display	Selection	Description
is displayed		Automatic start	Measuring will start after the heated cover has been closed.
is not displayed		Manual start	Measuring starts after the START button has been pressed, regardless of whether the heated cover is open or closed.

□ Press **ESC** to return to Moisture analysis mode.

10 Miscellaneous settings

10.1 Enter sample designation

A 4-digit sample code can be saved for a sample under menu item “**CoDE**”. This is output in the measuring protocol.

Options:

1st and 2nd digit: „0 – 9“ or „A – Z“ or „_“

3th and 4th digit: “0-9” (the value is automatically increased by “1” for each measurement, it reverts to “00” upon reaching “99”)

Default setting: „0000“

⇒ Press the **Menu** button to access the menu and the first menu item “PRoGRM” will be displayed.



⇒ Use the navigation keys **↓** **↑** to select the menu item „**CoDE**“ .

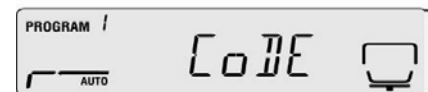

⇒ Press **ENTER** to confirm and a 4-digit number will be displayed. The active digit is flashing.



⇒ Use the navigation buttons to enter the required sample designation, see chap. 7.1.1 “Numerical input”.

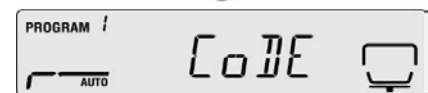
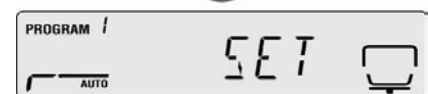

⇒ Press **ESC** to return to Moisture analysis mode.



10.2 Set date/time for measuring protocol

⇒ Press the **Menu** button to access the menu and the first menu item “PRoGRM” will be displayed.



⇒ Use the navigation key **↓** **↑** to select menu item „DATE“.



⇒ Press **ENTER** to confirm and the currently preset date format will be displayed.



⇒ Use navigation buttons **↓** **↑** to select the required format.

Display	Description
[YYMMDD]	Year/Month/Day
[MMDDYY]	Month/Day/Year
[DDMMYY]	Day/Month/Year



⇒ Press **ENTER** to confirm and the currently preset date will be displayed. The active digit is flashing.



⇒ Use the navigation buttons to enter the current date, see chap. 7.1.1 “Numerical input”.

⇒ Confirm with **ENTER** button, the currently set time will be displayed. The active digit is flashing.



⇒ Use the navigation buttons to enter the current time, see chap. 7.1.1 “Numerical input”.



⇒ Confirm input with **ENTER** button.

⇒ Press **ESC** to return to Moisture analysis mode.



10.3 Menu Lock

The menu setting operations can be locked so that the settings cannot be changed. The following menu blocks are available despite menu lock.

- ☞ PRG-No / call up drying programs, see chap. 9.1
- ☞ LoCK / menu lock, current chap.
- ☞ PRINT / output of measuring results, see chap. 11.4

Activate menu lock:

1. Press the **Menu** button to access the menu and the first menu item "PRoGRM" will be displayed.



2. Use the navigation key \downarrow \uparrow to select menu item „LoCK“.



3. Acknowledge using **ENTER** key, the password inquiry is displayed. The active digit is flashing.



4. Use the navigation buttons to enter a new password, see chap. 7.1.1 "Numerical input".



☞ Default setting: „9999“.

☞ Change password, see following chapter

☞ If the correct password has been entered, „ok“ will be displayed.

☞ If the password has been entered incorrectly, „NG“ will be displayed. Repeat password input from step 1.

5. Press **ENTER** to confirm. The current setting will be displayed.



⇒ Press **ESC** if „LoCK“ is displayed.



⇒ The menu lock is activated. The equipment reverts to Moisture analysis mode.



Remove the menu lock

- ⇒ Repeat steps 1-5.
Press **ENTER** to confirm. The current setting will be displayed.
- ⇒ Press **ESC** if “**LOCK**” is displayed.

- ⇒ The menu lock is cancelled. The equipment reverts to Moisture analysis mode.

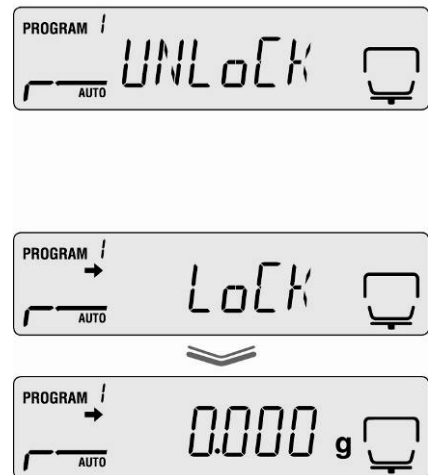

10.4 Change password

i Standard password (factory setting): „9999“

1. Press the **Menu** button to access the menu and the first menu item “**PRoGRM**” will be displayed.
2. Use the navigation key **↓** **↑** to select menu item „**PASS**“.
3. Acknowledge using **ENTER** key, the password inquiry is displayed. The active digit is flashing.
4. Use the navigation buttons to enter the currently set password, see chap. 7.1.1 “Numerical input”.

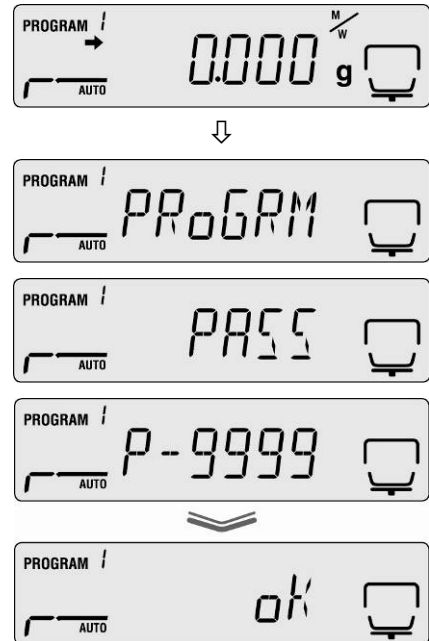

☞ Default setting: „9999“.

☞ If the correct password has been entered, „**ok**“ will be displayed.

☞ If the password has been entered incorrectly, „**NG**“ will be displayed.
Repeat password input from step 1.

⇒ Use the navigation buttons to enter a new password, see chap. 7.1.1 “Numerical input”.

⇒ Press **ENTER** to save the input and the display will change to “**SET**” followed by “**PASS**”.

⇒ Press **ESC** to return to Moisture analysis mode.

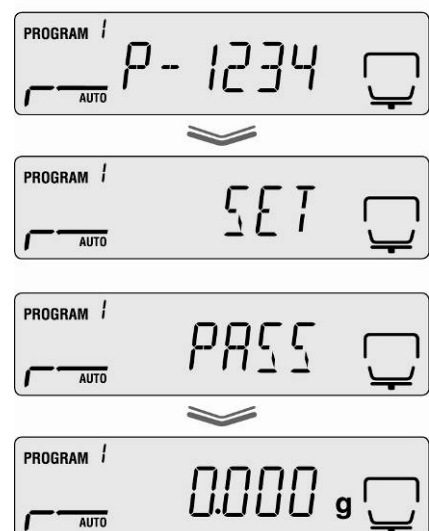

10.5 Enter identification number

Options:

Four characters, to select from „0 – 9“ or „A –Z“ or „_“

Default setting: ID „0000“

⇒ Press the **Menu** button to access the menu and the first menu item “PRoGRM” will be displayed.

⇒ Use the navigation keys **↓** **↑** to select the menu item „ID“ .

⇒ Press **ENTER** to confirm and a 4-digit number will be displayed. The active digit is flashing.

⇒ Enter the desired ID no. using navigation buttons (see chapter 3.1.1 „Numeric input“).

⇒ Press **ENTER** to save the input and the display will change to “SET” followed by “ID”.

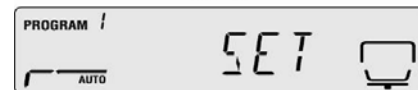
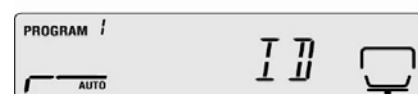

⇒ Press **ESC** to return to Moisture analysis mode.

10.6 Resetting the menu

A menu reset will return all the settings to factory setting.

⇒ Press the **Menu** button to access the menu and the first menu item “PRoGRM” will be displayed.



⇒ Use the navigation keys **↓** **↑** to select the menu item „RESET“ .



⇒ Acknowledge with **ENTER** key, „RST.OK?“ will be displayed.



⇒ Confirm query with **ENTER** key.



All settings will be reset to factory settings.



⇒ Press **ESC** to return to Moisture analysis mode.



11 Print, store and call-up measurement results

The data exchange between moisture analyser and printer occurs via the RS 232C interface.

In addition to the measurement result, for the finished drying process all drying parameters are automatically stored with the printout (100 positions). The memory location designation is automatically allocated with a consecutive number (XX00 – XX99) as well as a selectable designation “XX” (see chap. 10.1).

- ☞ Call up and print out measuring results, see chap. 11.4
- ☞ Delete memory, see Chapter 11.6

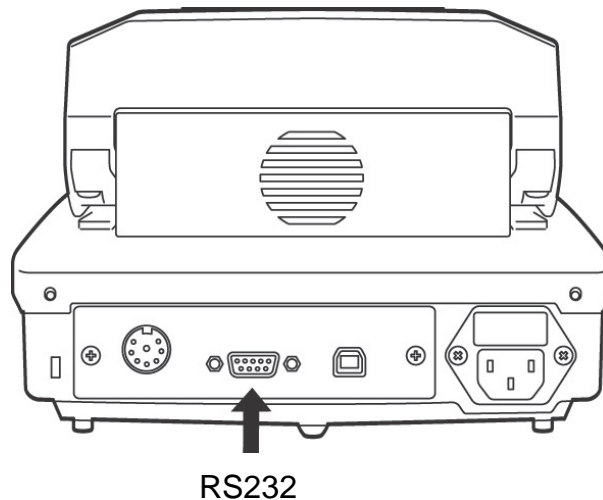

The following conditions must be met to provide successful communication between the moisture analyser and the printer.

- Disconnect moisture analyser from the power supply and connect to the printer interface with a suitable cable. Faultless operation requires an adequate KERN interface cable.
- Communication parameters (baud rate, bits and parity) for moisture analyser and printer must concur, see chap. 11.2.

11.1 Pin allocation RS232C interface

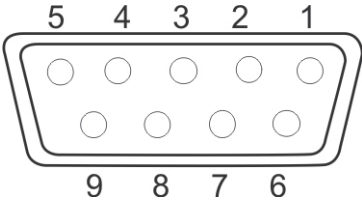

Printer			KERN DBS	
RXD	2	—————	2	TXD
TXD	3	—————	3	RXD
DTR	4	—————	4	DSR
SG	5	—————	5	SG
DSR	6	—————	6	DTR
RTS	7	⌋ ⌋	7	CTS
CTS	8	⌋ ⌋	8	RTS
NC	9		9	

11.2 Interface parameters

1. Press the **Menu** button to access the menu and the first menu item “**PRoGRM**” will be displayed.



2. Use the navigation buttons **↓** **↑** to select menu item „**CoM.SET**“.



3. Confirm with **ENTER** key, the currently preset port will be displayed

oUT.1 = RS232

oUT.2 = USB



4. Use the navigation keys to select **↓** **↑** „**oUT.1**“.

5. Press **ENTER** to save input and the currently preset baud rate will be displayed.



6. Use the navigation buttons **↓** **↑** to select the desired setting.

7. Press **ENTER** to save input, the next interface parameter will be displayed.

Set all interface parameters in turn and then repeat steps 6 and 7 in each case.

- **Baud rate**

Selectable settings:

Display	B.1200*	B.2400	B.4800	B.9600	B.19.2k	B.38.4k
Baud rate	1200bps	2400bps	4800bps	9600bps	19.2k bps	38.4k bps

- **Parity**

Selectable settings:

Display	P.NoNE*	P.oDD	P.EVEN
Parity	Small parity, 8 bit	Odd parity, 7 bit	Straight parity, 7 bit

- **Stop bit**

Selectable settings:

Display	SToP. 1*	SToP. 2
Stop bit	1 bit	2 bit

- **Handshake**

Selectable settings:

Display	HS.HW*	HS.SW	HS.TiM	HS.oFF
Handshake	Hardware handshake	Software handshake	Timer handshake	No handshake

- **Delimiter (terminator)**

Selectable settings:

Display	CR*	LF	CR+LF
Terminator	CR	LF	CR+LF

Press **ESC** to return to Moisture analysis mode.



i Factory settings are marked by *.

11.3 Output interval

⇒ Press the **Menu** button to access the menu and the first menu item “**PRoGRM**” will be displayed.



⇒ Use the navigation keys **↓** **↑** to select the menu item „**PRINT**“.

⇒ Acknowledge with **ENTER** key, “**INTVAL**“ will be displayed.

⇒ Press **ENTER** to save input and the currently preset output interval will be displayed.

⇒ Use the navigation buttons **↓** **↑** to select the desired setting.

Selectable settings:

oFF	No data output
1SEC	Output interval 1 sec
2SEC	Output interval 2 sec
5SEC	Output interval 5 sec
10SEC	Output interval 10 sec
30SEC	Output interval 30 sec
1MIN	Output interval 1 Min.
2MIN	Output interval 2 Min.
5MIN	Output interval 5 Min.
10MIN	Output interval 10 Min.
FINAL	Data output at end of measurement

⇒ Press **ENTER** to save input and the equipment will revert to the menu.

⇒ Press **ESC** to return to Moisture analysis mode.



11.4 Call up and print out measuring results

⇒ Press the Menu button to access the menu and the first menu item “**PRoGRM**” will be displayed.



⇒ Use the navigation keys ↓ ↑ to select the menu item „**PRINT**“.



⇒ Press **ENTER** to confirm.

⇒ Use the navigation keys ↓ ↑ to select the menu item „**MEMoRY**“.



⇒ Press **ENTER** to confirm. All drying processes will be output to the printer.

⇒ Press **ESC** to return to Moisture analysis mode.



- The **ESC** key may be used to cancel the data output.
- For printout sample see chapter 11.7

11.5 Print out currently preset drying parameters

⇒ Press the **Menu** button to access the menu and the first menu item “**PRoGRM**” will be displayed.



⇒ Use the navigation keys **↓** **↑** to select the menu item „**PRINT**“.



⇒ Press **ENTER** to confirm.

⇒ Use the navigation keys **↓** **↑** to select menu item „**CND.oUT**“.



⇒ Press **ENTER** to confirm. The currently preset drying parameters will be output to the printer.



⇒ Press **ESC** to return to Moisture analysis mode.

i For printout sample see chapter 11.7

11.6 Delete measuring results from memory

- ⇒ Press the **Menu** button to access the menu and the first menu item “**PRoGRM**” will be displayed.
- ⇒ Use the navigation keys **↓** **↑** to select menu item „**MEM.CLR**“.
- ⇒ Confirm with **ENTER** key, the query **CLR.oK?** will be displayed.
- ⇒ Press **ENTER** to confirm. The entire memory content will be deleted.
- ⇒ Press **ESC** to return to Moisture analysis mode.



11.7 Printout examples

1. Moisture analysis measuring protocol

KERN & Sohn GmbH	
TYPE	DBS60-3
SN	WBIIAH0000I
ID	0000
CODE	0006
DATE	10-05-11
TIME	10:17
PNO.	6
UNIT	M/W
MODE	TIME
TEMP	120C
STOP	00:02
WET W(s)	1.638
TIME	M/W (%)
00:00:00	0.00
00:00:30	0.10
00:01:00	0.14
00:01:30	0.16
00:02:00	0.18
* 00:02:00	0.18
Dry W(g)	1.635

Company
Model
Serial no.
Identification No. (see chap. 10.5)
Sample designation (see chap. 10.1)
Date (see chapter. 10.2).
Time
Program No. (see chap.9.1)
Results display unit(see chap. 9.2.2)
Drying mode (see chap. 9.2.1)
Drying temperature e.g. 120 °C
Switch-off criterion, e.g. 2 min.
Starting weight e.g. 1.638g
Output interval Measuring value
Measuring result in the preset unit (see chap. 9.2.2)
Residual weight e.g. 1.635g

2. Adjustment log „Balance“

```
-----  
CAL-BALANCE  
-----  
KERN & Sohn GmbH  
  
TYPE DBS60-3  
SN WBIIAH0000I  
ID 0000  
  
DATE 10-05-11  
TIME 10:17  
  
REF= 50.000g  
BFR= 50.002g  
AFT= 50.000g  
  
-COMPLETE  
  
-SIGNATURE-  
  
-----
```

Adjust balance (see chap. 6.1)

Company

Model

Serial no.

Identification No. (see chap. 10.5)

Date

Time (see chap. 10.2).

Used adjustment weight

Before adjustment

After adjustment

Signature Processor

3. Adjustment log „Temperature“

CAL-TEMPERATURE

KERN & Sohn GmbH

TYPE DBS60-3
SN WBIIAH0000I
ID 0000

DATE 10-05-11
TIME 10:17

REF= 100C
BFR= 100C
AFT= 100C

REF= 180C
BFR= 181C
AFT= 180C

-COMPLETE

-SIGNATURE-

Adjust temperature (see chap. 6.2)

Company

Model

Serial no.

Identification No. (see chap. 10.5)

Date

Time (see chap. 10.2).

First temperature point

Temperature before adjustment

Temperature after adjustment

Second temperature point

Temperature before adjustment

Temperature after adjustment

Signature Processor

12 General information concerning moisture analysis

12.1 Application

In all cases where moisture is added to or removed from products, a fast determination of the moisture content is of enormous importance. For countless products the moisture content is not only a quality feature but also an important cost factor. Very often fixed limits for moisture content apply to the trade in industrial or agricultural goods as well as chemical or food products which are defined by terms of delivery and general standards.

12.2 Basics

Moisture does not only mean water but includes all substances that evaporate when heated up. In addition to water this includes,

- Fats
- Oils
- Alcohol
- Solvent
- etc...

There are various methods to analyse moisture in a product.

KERN DBS uses a method called thermogravimetrics. In accord with this method, the sample is weighed before and after heating, determining the material moisture by looking at the difference.

The conventional drying chamber method follows the same principle, with the exception that this method requires a considerably longer measuring period. . In accord with the drying chamber method, the sample is heated from the outside to the inside by a hot air current, so as to remove the moisture. The radiation applied in the KERN DBS penetrates mainly the sample in order to be transformed inside it into heat energy that is, warming from the inside to the outside. A minor amount of radiation is reflected by the sample, a reflection that is less in dark samples than in light-coloured ones. The depth of penetration of the radiation depends on the permeability of the sample. In samples of low permeability the radiation only penetrates the outer layers of the sample, possibly resulting in imperfect drying, incrustation or burning. For that reason the preparation of a sample is of great importance.

12.3 Adjustment to existing measuring method

Quite frequently the KERN DBS replaces a different drying method (such as a drying chamber) as the KERN DBS achieves shorter measuring times during a simplified operation. For that reason the conventional measuring method must be matched to the KERN DBS in order to achieve comparable results.

- Carry out parallel measurement
 - Lower temperature setting for KERN DBS than drying chamber method
- Result of KERN DBS does not match reference
 - Repeat measurement with changed temperature setting
 - Vary switch-off criterion

12.4 Preparing a sample

Prepare one sample at a time for measuring. This prevents the sample from exchanging moisture with its surroundings. If several samples have to be taken at the same time, they should be packed in airtight boxes so that they do not undergo changes during storage.

To receive reproducible results, spread the sample thinly and evenly on a sample dish.

Patchy spreads will produce inhomogeneous heat distribution in the sample to be dried resulting in incomplete drying and increased measuring time. Sample clusters generate increased heating of the upper layers resulting in combustion or incrustation. The high layer thickness or possibly arising incrustation makes it impossible for the moisture to escape from the sample. Due to this residual moisture, measured results calculated in this way will not be comprehensible or reproducible.

Preparing a sample from solids:



- Spread powdery or grainy samples evenly on the sample dish.
- Grind coarse samples using a mortar or a shredder. When grinding the sample avoid any heat supply as this may cause loss of humidity.

Preparing a sample from liquids:



For liquids, pastes or melting samples we recommend to use a glass fiber filter. The glass fiber filter has the following advantages:

- Even distribution thanks to capillary attraction
- no formation of droplets
- fast evaporation due to a greater surface

12.5 Sample material

Easy to determine are usually samples with the following characteristics:

- Grainy to powdery, pourable solids
- Thermally stable materials, emitting the moisture to be determined easily without other substances evaporating at the same time
- Liquids that vaporize to leave a dry substance without developing a film

Difficult to determine may be samples that are:

- Glutinous or sticky
- Become incrustrated easily or tend to form a film
- Decompose easily under the influence of heat or emit various elements

12.6 Sample size / originally weighted in quantity

Drying times, as well as achievable accuracy, are significantly influenced by sample distribution. In the course of this arise two opposed requirements:

The lighter the originally weighted in quantity, the easier it is to achieve shorter drying times.

However, the heavier the originally weighted in quantity, the more accurate a result.

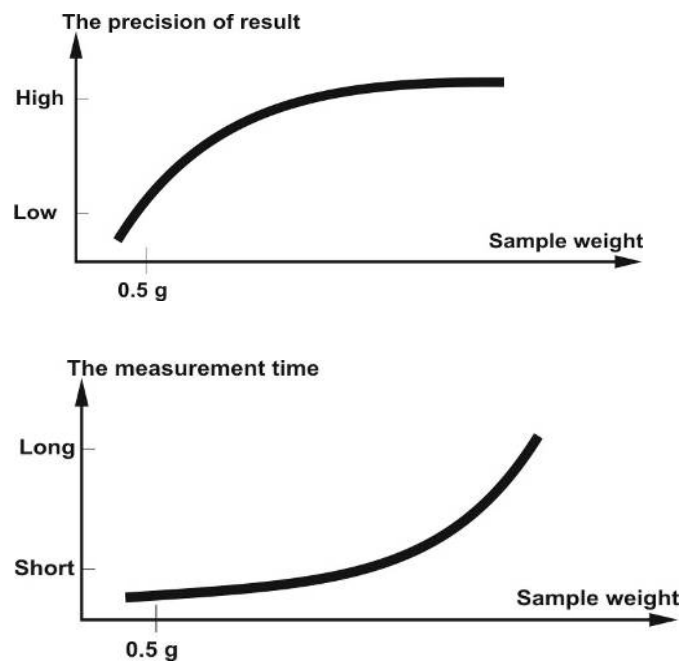

12.7 Drying temperature

Bear in mind the following factors when setting the drying temperature:

Surface of the sample:

Compared with powdery or grainy samples, liquid and spreadable samples have a smaller surface for the transmission of heat energy.

The use of a glass fibre filter improves the heat application.

Colour of sample:

Light-coloured samples reflect more heat radiation than dark ones and therefore require a higher drying temperature.

Availability of volatile substances:

The better and faster the water or other volatile substances can be disposed, the lower a drying temperature is required. If water is difficult to get to (e. g. in synthetics), it has to be calcined at high temperatures (the higher the temperature, the higher the water vapour pressure).

Results equivalent to other moisture analysing methods (e. g. drying chamber) can be achieved by experimentally optimising the setting parameters such as temperature, heating level and shutoff criteria.

12.8 Recommendations / Guidelines

Prepare standard sample:

- Crush sample, as required, and spread it evenly in the aluminium dish.

Prepare special samples:

- For sensitive or hard to spread test materials (e. g. mercury) a glass fibre filter is available for use.
- Apply the sample equally on the glass fibre filter and cover it with a second glass fibre filter.
- The glass fibre filter is also useful as a protection when splashing materials are dealt with (each splash falsifies the final result).

Table of applications:

Material	Weight Sample (g)	Drying temperature (°C)	Drying period (approx.) (min)	Moisture % (approx.)	Solid body % (approx.)
ABS (Novodur P2H-AT)	10	60	10	0.11	
Accumulator lead	10	110	2,6	0.19	
Acryl granulate	10-15	80	12	0.18	
Activated carbon	10	80	9,8	13.33	
Activated carbon	7.6	80	4.1	6.12	
Sliced pineapple	5	110	14.4	6.71	
Sliced apple (dry)	5-8	100	10-15	76.5	
Sliced apple (humid)	5-8	100	5-10	7.5	
Artesan powder	0.5	80	3.5		98.44
Aspartame granulate	0.5	105	3.4		96.84
Bath milk	3	80	27.4	83.87	
Cotton seed	3-4	110	6.3	6.8	
Blue-veined cheese	2	160	13.3		53.06
Body lotion	3	80	31.6	87.76	
Beans	4.5	150	9.7	11.85	
Butter	1.7	140	4.3		84.95
Acetyl cellulose	5.5-6	50	1.3	0.81	
Chinese Virility powder	2.5-3	110	5.5	6.24	
CN photographic paper	2	150	6.4	5.81	
Cornflakes	2-4	120	5-7	9.7	
Roof tile mass	2.5	160	10		81.74
Roof tile mass	7	160	20		81.74
Dialysis membrane (Polyethes – polycarbonate)	0.5	80	2.2	7.85	
Dialysis membrane (Polyethes – polycarbonate)	0.5-0.7	80	2.0	7.86	
Indoor sealing compound	3	160	7		64.04
Dispersion adhesive	1.5	140	9.5		55.69
Dispersion adhesive (watery)	2.5	155	7.2	43.77	
Dolomite	10-12	160	6.1	0.06	
Printer ink fluid	1.5	120	10		19.15
E-filter dust of waste incineration	7-10	135	7	26.23	
Peas, „danish yellow“	3.5	135	7.9	15.19	
Peanut cores	2.8	100	4	1.97	
Peanut cores	3	100	6	3.2	
Refreshment candies	3-3.4	90	2.9	0.29	
Dye powder	1.5	120	3.5		99.07
Fine ceramic mass	2.5	160	9		86.89
Film waste	8-9	60	1.2	0.4	
River water	4	160	20	99.2	
Fudge/sugar mass	5	130	20	8	
Formaldehyde urea dispersion	2	155	7.6	34.07	
Cottage cheese	1.4	70	15		41.03
Forage pellets	3-4	150	5.7	6.35	
Dried beans	3-4	105	5	7.3	
Dried peas	5-7	110	9.6	5.89	
Dried carrots	5.5-6	120	3	4.92	
Dried chicken dung	4	140	8	14.81	
Dried corn	5-7	110	10	6.21	
Glass powder	8-10	160	5	0.26	

Material	Weight Sample (g)	Drying temperature (°C)	Drying period (approx.) (min)	Moisture % (approx.)	Solid body % (approx.)
Setting lotion	0.01	145	9	98.76	
Setting lotion (extra strong)	1	130	8	97.85	
Hair styling gel	5	105	37.0	94.71	
Oat flakes	2	105	5.6	9.35	
Hazelnut cores	2.2	100	3.8	4	
Hazelnut cores (peeled)	2.6	100	4.5	3.74	
Hydranal sodium tatrata – 2 – hydrate	1.6	160	12	15.67	
Yoghurt	2-3	110	4.5-6.5	86.5	
Coffee	2	150	8	4.99	
Coffee cream	2-3	130	6-8	78.5	
Coffee seed	3.5-4	120	8	8.53	
Cocoa	2.5	105	4	3.45	
Cocoa seed	4-5	130	7.8	6.23	
Limestone	12-14	160	5	0.05	
Potato powder	2.5-3.0	130	5.8	12.46	
Potato chips	3-4	106	7.5	6.9	
Ketchup	2	120	18	74.44	
Silica gel	9.5	115	4.5	0.63	
Adhesive	2-5	136	6-8	54.3	
Garlic, powder	2	100	7.3	5.36	
Coal powder	4	160	3.4	2.11	
Chalk (natural)	8	160	1.7	0.06	
Crystal sugar	3	90	2.8	0.05	
Synthetic resin dispersion (diluted)	2	160	5.9	60.21	
Latex	1-2	160	5.2	38.64	
Latex LE ¹	3-5	125	10.8	46.58	
Latex LE ²	3-5	125	9.4	50.37	
Latex O44	3-5	125	9.4	50.65	
Lentils	4	135	5.4	12.49	
Loam soil	10-15	160	5.5	9.89	
Loam clay	2.5	160	14.5		80.75
Skim milk powder	4	90	5.5	3.67	
Low fat curd cheese	1.2	130	8		18.5
Corn starch	2	160	5.2		89.1
Almonds (caramelised)	3.5	80	4.8	1.81	
Almonds (natural)	2.5	100	5.3	4.19	
Almonds „californian“	3	100	5.3	4.34	
Margarine	2.2	160	4	19.15	
Brick mass	7	160	20		80.13
Mayonnaise	1-2	138	10	56.5	
Flour	8-10	130	4.5	12.5	
Micronyle	7-8	60	8	0.4	
Milk	2-3	120	6-8	88	
Milk powder (MMP)	4.5	100	6.3	2.46	
Milk powder (VMP)	4.5	100	5.5	2.56	
Mozzarella	1.5	160	11.1		45.78
Multivitamin candies	3-3.4	115	3.3	0.4	
Natural latex	1.4	160	5.3	42.56	
Nougat mass	2.5	103	10	0.6	
Noodle dough	0.55	160	5	12	
Concentrated orange juice	2-3	115	13	52.1	

Material	Weight Sample (g)	Drying temperature (°C)	Drying period (approx.) (min)	Moisture % (approx.)	Solid body % (approx.)
Paper	2-4	106	10	6.4	
PA 6 (Ultramide B3WG5)	10	60	10	0.05	
PA 6.6 (Ultramide B3WG5)	10	80	10	0.15	
PBTP (Crastin SK645FR)	10	80	10	0.05	
PC (Macrolon 2805)	10-12	80	15	0.08	
PC/ABS (Babyblend T65MN)	9-11	80	10	0.12	
Pepper, black, powder	2	85	8.8	7.97	
PMMA (Plexiglass 6N)	10	70	10	0.12	
Polypropylene	13	130	9	0.23	
Polypropylene	3.3	120	2.2	0.09	
Polystyrene sulfonic acid Sodium salt solution	2-2.5	120	8.7	19.01	
POM (Hostaform C9021))	10	80	10	0.13	
PS (Polystyrene 168 N)	10	80	10	0.05	
Purine	2	105	3.8	8.64	
Curd	1	140	7		18
Curd cheese, „Fat curd cheese“	1.2	130	8		23
Silica sand	10-14	160	1.9	0.24	
Raclette cheese	1.5	160	14.4		56.9
Canola seed	3-4	90	7.4	6.18	
Rice (US parboiled)	3.5	105	12.5	10.98	
Rye	4.5	150	11.5	10.72	
Red wine	3-5	100	15-20	97.4	
Sugar beet pulp pellets	4.5	150	8.6	11.77	
Salt	2	100	3	4.9	
Pretzel sticks	3-4	75	4.5	1.67	
Sludge	11-12	130	90	80	
Melted cheese	1.5	70	15	35.65	
Chocolate	2.5	103	10	0.5	
Chocolate powder	2-4	100	4	1.9	
Chocolate water	2-3	90	10		6
Hogwash of kitchen waste	4-5	160	21		17.67
Lard	0.70	160	3.5	1.2	
Shampoo	2	100	14.1	75.89	
Soap	3	120	6	7.86	
Mustard	2.5-3	80	19		34.69
Sesame seed	3	130	8	5.48	
Soya bean flour	4.6	95	4.9	4.8	
Soya beans, granulate	5	110	22.6	12.16	
Bruised sunflower seed	3-3.5	100	4	5.92	
Sunflower oil	10-14	138	2	0.1	
Spaghetti	3	105	15.1	10.63	
Rinsing agent	2	80	13.7	59.64	
Dust	5-10	104	8-15	7.3	
Starch derivative	2.5	150	12.3		30.29
Starch glue	1.5	100	8.9		17.96
Spread cheese	2.5-2.8	160	4.5		36.81
Soup (instant product)	2-3	80	4.5-7	3	

Material	Weight Sample (g)	Drying temperature (°C)	Drying period (approx.) (min)	Moisture % (approx.)	Solid body % (approx.)
Tobacco	1.5	100	16	10.18	
Tea, black	2	105	4	7.67	
Pasta	1.5	120	8	10.64	
Textile fibre	0.8-1.2	85	3.6	14.03	
Theophylline	1.5	130	1.9	7.33	
Thermoplastic PUR – granulate	15-18	80	18	0.08	
Walnut	2.8	100	5.6	3.5	
Washing powder	2	160	12	7.32	
Wheat spring water	2-3	90	10		6
Sausage casing	0.2	150	3.5		78.56
Toothpaste	2	100	7.7	34.28	
Pulp	2.5	130	4.5	7.32	
Cement	8-12	138	4-5	0.8	
Sugar	4-5	138	10	11.9	
Sugar beets	2	130	13.4		30.94

For real-life examples please refer to our application manual by going to our KERN Homepage (www.kern-sohn.com).

13 Service, maintenance, disposal

13.1 Cleaning



☞ Before any maintenance, cleaning and repair work disconnect the appliance from the operating voltage.



☞ Only carry out cleaning tasks when the equipment has cooled down.

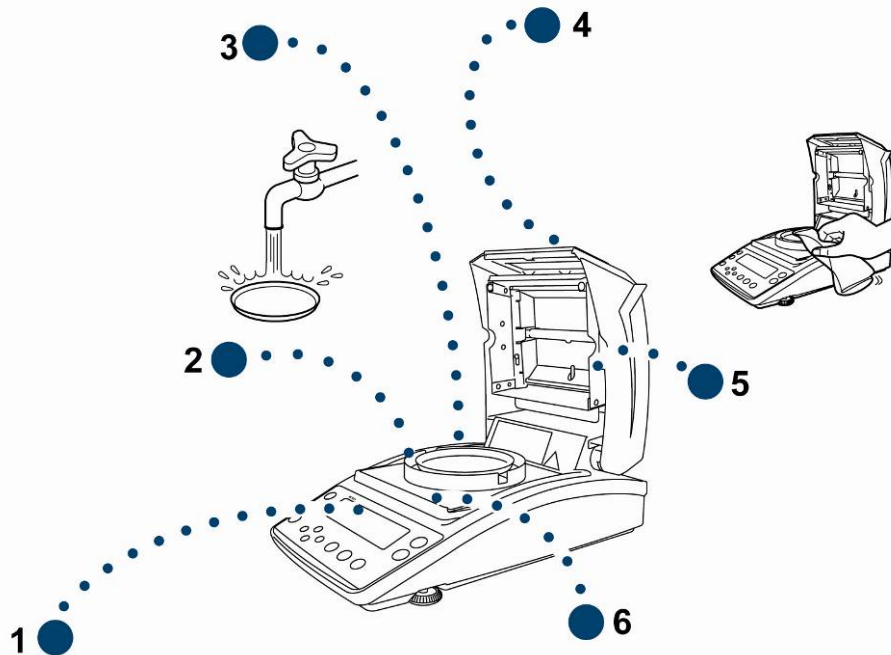

1. Display	Please do not use aggressive cleaning agents (solvents or similar agents), but a cloth dampened with mild soap suds.
2. Wind protection ring	Remove wind protection ring / sample dish, wet clean and dry thoroughly before fitting
3. Sample dish	
4. Housing	Please do not use aggressive cleaning agents (solvents or similar agents), but a cloth dampened with mild soap suds. Take care that the device is not penetrated by fluids and polish it with a dry soft cloth. Loose residue sample/powder can be removed carefully with a brush or manual vacuum cleaner. Remove any spilt sample material immediately.
5. Protective glass guard	Remove protective glass guard (see chap. 13.1.1) and clean with a commercially available glass cleaner.
6. Heat shield	Remove heat shield, wet clean and dry thoroughly before fitting

13.2 Service, maintenance

- ⇒ The appliance may only be opened by trained service technicians who are authorized by KERN.
- ⇒ Ensure that the balance is regularly calibrated, see chap. Testing instruments control.

13.2.1 Remove protective glass guard



✎ Avoid contact with halogen lamp and sensor!

✎ Handle protective glass guard with care.

Attention: Risk of breakage

✎ Risk of cuts.

1. Open heated cover.

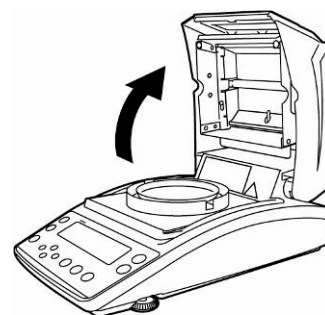

2. Undo the screws marked with arrows with the hexagonal socket wrench included in the scope of supply.

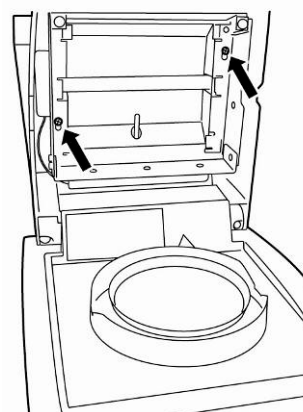

3. Remove protective glass guard and clean with a commercially available glass cleaner.

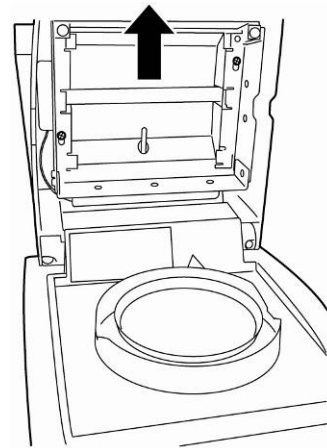

Glass plate [1] can be removed if necessary by undoing the screws [2].

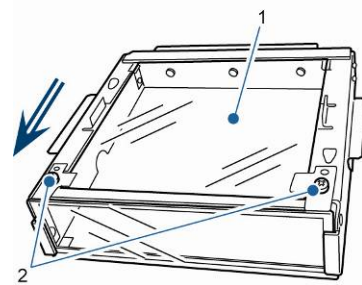

4. Refit the cleaned protective glass guard in reverse order.

13.2.2 Lamp change

- ✎ Disconnect equipment from power supply.
- ✎ Only change the lamp when the equipment has cooled down.

1. Remove protective glass guard, see chap. 13.2.1

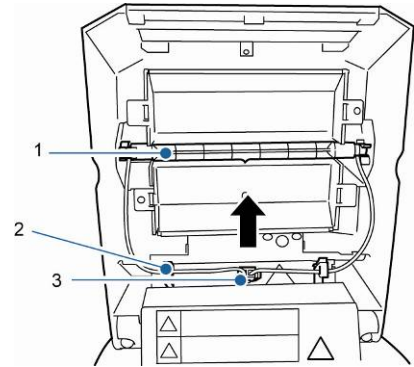

- 1. Light
- 2. terminal
- 3. Plug connector

2. Remove plug connector [3]. Remove cable from terminals [2] with care.

3. Loosen lamp [1] from the clips [4] on both sides.

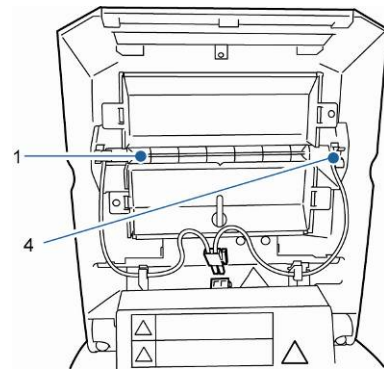

- 4. Clips

4. Install new lamp in reverse order.



Avoid contact with the halogen lamp to maintain service life.

Position plug connector in accordance with illustration.

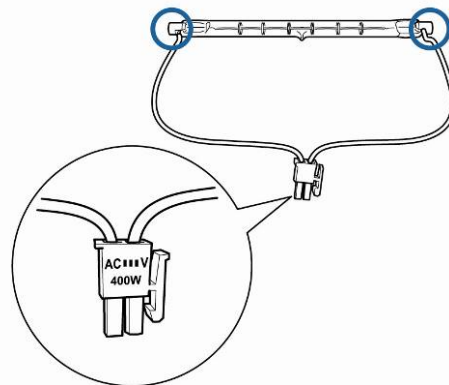

Fit protective glass guard, see chap. 13.2.1

13.2.3 Replacing fuses

- ✎ Disconnect equipment from power supply.
- ✎ Only use 6.3 A microfuses

1. Remove fuse box (see chap. 2, Item 15) from the back of the equipment and change the fuse in accordance with the illustration.

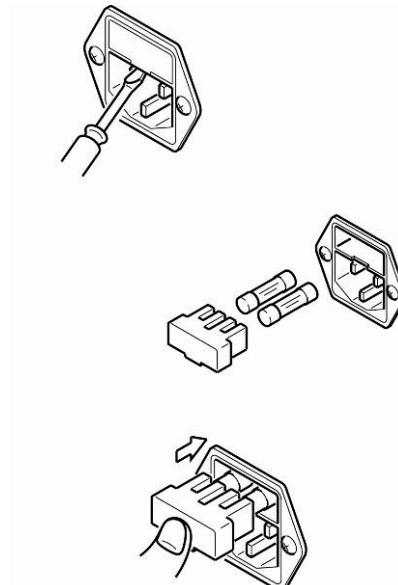

13.3 Disposal

- Disposal of packaging and appliance must be carried out by operator according to valid national or regional law of the location where the appliance is used.

14 Instant help

Fault

Possible cause

Display is not lit up.

- The display unit is not switched on.
- The mains supply connection has been interrupted (mains cable not plugged in/faulty).
- Power supply interrupted.
- Fuse has blown

The display does not change when a sample is being loaded

- Sample dish / dish holder is fitted incorrectly.

The weight display changes constantly / the stability display → does not appear.

- Sample dish has contact with wind protection device or heated cover.
- Draught/air movement
- Table/floor vibrations
- Electromagnetic fields / static charging (choose different location/switch off interfering device if possible)

Incorrect measuring result

- Check adjustment
- No resetting to zero before loading the sample

Measurement is taking too long

- Incorrect setting shutoff criterion

Measurement is not reproducible

- Sample is not homogenous
- Drying time is too short
- Drying temperature too high (e.g. oxidation sample material, boiling point of sample exceeded)
- Temperature sensor soiled or defective

Drying does not start

- Heated cover open
- The mains supply connection has been interrupted (mains cable not plugged in/faulty).

14.1 Error messages

Error message	Explication	Remedy
ERR.001 ERR.002	Hardware error	Switch equipment off and on again. If the error message remains inform manufacturer.
ERR.005	Memory error	Switch equipment off and on again. If the error message remains inform manufacturer.
ERR.100	Heated cover is open for more than 1 minute during measuring.	Press ESC to abort measuring.
ERR.101 ERR.102	Failure „Temperature sensor“	Switch equipment off and on again. If the error message remains inform manufacturer.
ERR.110	Heated cover not closed properly	Press ESC to abort measuring.
TIM.oUT	Measuring start 30 minutes after resetting to zero	Press ESC to abort measuring.
ERR.121 ERR.122 ERR.123	Failure „Heating“	Switch equipment off and on again. If the error message remains inform manufacturer.
ERR.124	Measuring lasts too long	Check drying time switch-off criterion or ΔM
ERR.200	Failure „Current supply“	Switch equipment off and on again. If the error message remains inform manufacturer.
ERR.201	Internal error	Switch equipment off and on again. If the error message remains inform manufacturer.
ERR.202	Failure „Electrical voltage“	Switch equipment off and on again. If the error message remains inform manufacturer.

ERR.C01 ERR.C02 ERR.C04 Adjustment error	High zero point shift during adjustment	Press ESC to abort and repeat adjustment procedure.
	There are objects in the sample dish	
	Missing sample dish	
ERR.oL ERR.-oL	Overload	Check sample dish
CoM.ERR	Wrong remote control order.	Correct remote control order.
oL -OL	Overload	Install sample dish correctly Reduce sample weight
ABORT	Process cancelled	Press ESC to return to Weighing mode

Should other error messages occur, switch balance off and then on again. If the error message remains inform manufacturer.

15 Declaration of conformity



KERN & Sohn GmbH

D-72322 Balingen-

Frommern

Postfach 4052

E-Mail: info@kern-sohn.de

Tel: 0049-[0]7433- 9933-0

Fax: 0049-[0]7433-9933-149

Internet: www.kern-sohn.de

Declaration of conformity

EG-Konformitätserklärung

EC- Déclaration de conformité

EC-Dichiarazione di conformità

EC- Declaração de conformidade

EC-Deklaracja zgodności

EC-Declaration of -Conformity

EC-Declaración de Conformidad

EC-Conformiteitverklaring

EC- Prohlášení o shode

EC-Заявление о соответствии

D	Konformitäts- erklärung	Wir erklären hiermit, dass das Produkt, auf das sich diese Erklärung bezieht, mit den nachstehenden Normen übereinstimmt.
GB	Declaration of conformity	We hereby declare that the product to which this declaration refers conforms with the following standards.
CZ	Prohlášení o shode	Tímto prohlašujeme, že výrobek, kterého se toto prohlášení týká, je v souladu s níže uvedenými normami.
E	Declaración de conformidad	Manifetamos en la presente que el producto al que se refiere esta declaración está de acuerdo con las normas siguientes
F	Déclaration de conformité	Nous déclarons avec cela responsabilité que le produit, auquel se rapporte la présente déclaration, est conforme aux normes citées ci-après.
I	Dichiarazione di conformità	Dichiariamo con ciò che il prodotto al quale la presente dichiarazione si riferisce è conforme alle norme di seguito citate.
NL	Conformiteit- verklaring	Wij verklaren hiermede dat het product, waarop deze verklaring betrekking heeft, met de hierna vermelde normen overeenstemt.
P	Declaração de conformidade	Declaramos por meio da presente que o produto no qual se refere esta declaração, corresponde às normas seguintes.
PL	Deklaracja zgodności	Niniejszym oświadczamy, że produkt, którego niniejsze oświadczenie dotyczy, jest zgodny z poniższymi normami.
RUS	Заявление о соответствии	Мы заявляем, что продукт, к которому относится данная декларация, соответствует перечисленным ниже нормам.

Electronic Balance: KERN DBS

EU Directive	Standards
2004/108/EC	EN 61326-1:2006
2006/95/EC	EN 61010-1: 2010 EN 61010-2-010: 2003

Datum 27.03.2013

Date

Signatur

Signature

Ort der Ausstellung 72336 Balingen

Place of issue

Albert Sauter
KERN & Sohn GmbH
Geschäftsführer
Managing director

KERN & Sohn GmbH, Ziegelei 1, D-72336 Balingen, Tel. +49-[0]7433/9933-0
Fax +49-[0]7433/9933-149, E-Mail: info@kern-sohn.com, Internet: www.kern-sohn.com