



KERN & Sohn GmbH

Ziegelei 1

D-72336 Balingen

E-Mail: info@kern-sohn.com

Phone: +49-[0]7433- 9933-0

Fax: +49-[0]7433-9933-149

Internet: www.kern-sohn.com

Operating manual

Counting balance/counting system

KERN CFS/CCS

Version 2.1

03/2014

GB

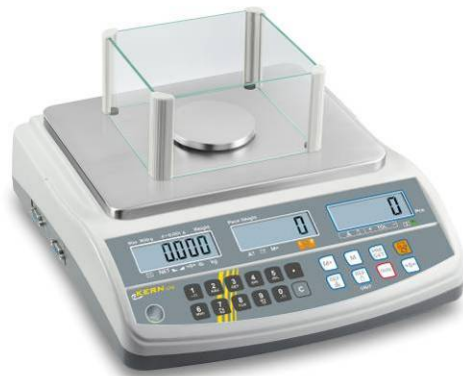

CFS/CCS-BA-e-1421



KERN CFS/CCS

Version 2.1 03/2014

Operating instructions Counting balance/counting system

Contents

1	Technical data	4
1.1	KERN CFS	4
1.2	Counting systems KERN CCS.....	7
2	Appliance overview	8
2.1	Counting scales KERN CFS.....	8
2.2	Counting systems KERN CCS.....	10
2.3	Counting systems with your selected bulk scales.....	10
2.4	Overview of display	12
2.4.1	Display weight.....	13
2.4.2	Display average piece weight	13
2.4.3	Display quantity.....	13
2.5	Keyboard overview.....	14
3	Basic instructions	17
3.1	Proper use	17
3.2	Improper Use.....	17
3.3	Warranty	17
3.4	Monitoring of Test Resources.....	18
4	Basic Safety Precautions	18
4.1	Pay attention to the instructions in the Operation Manual	18
4.2	Personnel training	18
5	Transport and storage	18
5.1	Testing upon acceptance	18
5.2	Packaging / return transport.....	18
6	Unpacking, Setup and Commissioning.....	19
6.1	Installation Site, Location of Use	19
6.2	Unpacking, Scope of delivery.....	19
6.2.1	Scope of delivery / serial accessories.....	19
6.3	Installing / removing transport fittings.....	20
6.4	Mains connection	21
6.5	Rechargeable battery operation (optional)	21
6.6	Connection of peripheral devices.....	22
6.7	Initial Commissioning	22
6.8	Adjustment	22
7	Basic Operation.....	23
7.1	Switching on/off.....	23
7.2	Zeroing.....	23
7.3	Switching over reference scale ⇄ bulk scales if used as counting system.....	23
7.4	Weighing with tare.....	25
7.4.1	Taring.....	25
7.4.2	Numeric entering of tare weight.....	25
7.4.3	Switch-over weighing unit	25
8	Parts counting	26

8.1	Determination of the average piece weight by weighing	27
8.2	Numeric input of the average piece weight	30
8.3	Automatic reference optimization	32
8.4	Counting with counting system	33
9	Fill-to-target function	35
9.1	Tolerance check for target weight	36
9.2	Tolerance check for target quantity	38
10	Totalization	40
10.1	Manual totalizing	40
10.2	Automatic adding-up	42
11	Store article information	43
11.1	Store article	43
11.2	Call article	46
11.3	Article direct keys  (only model CFS 50K-3)	47
12	Menu	49
12.1	Navigation in the menu	49
12.2	Menu overview	50
13	Configuration of bulk scale	52
14	Adjustment	58
14.1	Models CFS 300-3, CFS 3K-5	58
14.2	Models CFS 6K0.1, CFS 15K0.2, CFS 30K0.5	59
14.3	Model KERN CFS 50K-3	61
15	Linearization	62
15.1	Models CFS 300-3, CFS 3K-5	64
15.2	Model KERN CFS 50K-3	65
16	Second balance interface	67
17	RS 232C interface	68
17.1	Technical data	68
17.2	Printer operation	69
17.2.1	Printout example KERN YKB-01N / model CFS 300-3	69
17.2.2	Printout examples KERN YKB-01N / model CFS 3K-5	69
17.2.3	Printout examples KERN YKB-01N / CFS 6K0.1, CFS 15K0.2, CFS 30K0.5	71
17.2.4	Printout examples KERN YKB-01N / model CFS 50K-3	75
17.3	Remote control instructions	76
17.3.1	All models except for KERN CFS 50-3	76
17.3.2	Control commands	76
17.3.3	Printing commands	76
17.3.4	Model CFS 50-3	77
17.3.5	User identification, scale identification, store article name	77
17.3.6	Register / call article via RS232	77
17.4	I/O-function	78
18	Servicing, maintenance, disposal	79
18.1	Cleaning	79
18.2	Servicing, maintenance	79
18.3	Disposal	79
19	Instant help	80
19.1	Error messages	81
20	Declaration of conformity	82

1 Technical data

1.1 KERN CFS

KERN	CFS 300-3	CFS 3K-5	CFS 6K0.1
Readability (d)	0.001 g	0.01 g	0.1 g
Weighing range (max)	300 g	3 kg	6 kg
Reproducibility	0.002 g	0.02 g	0.1 g
Linearity	± 0.004 g	± 0.04 g	± 0.2 g
Stabilization time	2 s		
Weighing Units	g, lb	kg, lb	
Recommended adjusting weight (not supplied)	200 g(F1) + 100 g(F1)	2 kg(F1) + 1 kg(F1)	6 kg (F2)
Warm-up time	2 h		
Minimum unit weight at piece count	5 mg	50 mg	100 mg
Reference unit weights at piece counting	freely selectable		
Net weight (kg)	2.5 kg	3.8 kg	
Permissible ambient condition	0° C to 40° C		
Humidity of air	max. 80 % relative (not condensing)		
Weighing plate, stainless steel	∅ 80 mm	294 x 225 mm	
Dimensions wind screen [mm]	inside 158 x 143 x 61	-	
	outside 167 x 154 x 80		
Dimensions housing (l x L x h) [mm]	320 x 350 x 125 mm		
Mains connection	Mains adapter 230 V AC, 50 Hz; 12 V DC balance, 500 mA		
Rechargeable battery (optional)	Operating duration approx. 70 h / loading time approx. 12 hours		

KERN	CFS 15K0.2	CFS 30K0.5	CFS 50K-3
Readability (d)	0.2 g	0.5 g	1 g
Weighing range (max)	15 kg	30 kg	50 kg
Reproducibility	0.2 g	0.5 g	1 g
Linearity	± 0.4 g	± 1 g	± 2 g
Stabilization time	2 s		
Weighing Units	kg, lb		
Recommended adjusting weight (not supplied)	15 kg (F2)	30 kg (F2)	50 kg (F2)
Warm-up time	2 h		
Minimum unit weight at piece count	200 mg	500 mg	1 g
Reference unit weights at piece counting	freely selectable		
Net weight (kg)	3.8 kg		5.5 kg
Permissible ambient condition	0° C to 40° C		
Humidity of air	max. 80 % relative (not condensing)		
Weighing plate, stainless steel	294 x 225		370 x 240
Dimensions housing (l x L x h) [mm]	320 x 350 x 125		370 x 360 x 125
Mains connection	Mains adapter 230 V AC, 50 Hz; 12 V DC balance, 500 mA		
Rechargeable battery (optional)	Operating duration approx. 70 h / loading time approx. 12 hours		

Dimensions:

Models

- CFS 300-3
- CFS 3K-5
- CFS 6K0.1
- CFS 15K0.2
- CFS 30K0.5

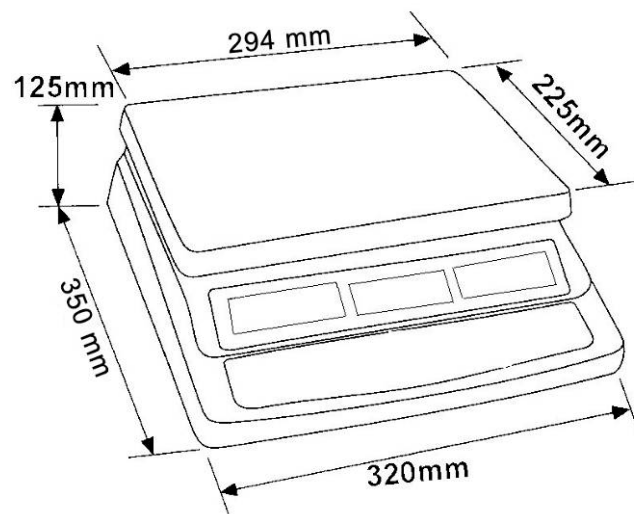

Model

- CFS 50K-3

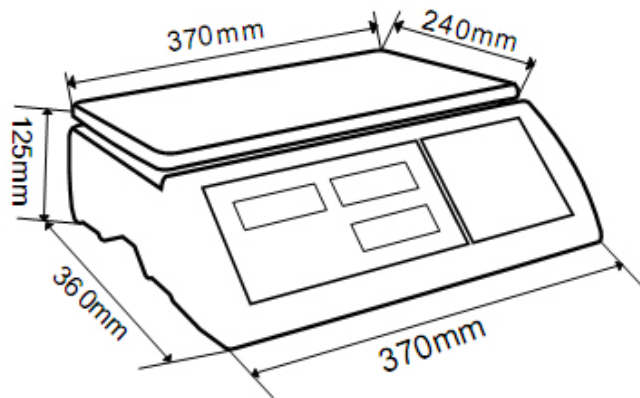

1.2 Counting systems KERN CCS

Model KERN	Bulk material balance KFP	Weighing range [Max] kg	Readability [d] g	Weighing pan	Recommended calibration weight, not included, kg [class F1]	Reference scale CFS	Weighing range [Max] g	Readability [d] g	Minimum piece weight [count] g/piece
CCS 6K-6	KFP 6V20M	6	2	230x230x100	6	CFS300-3	300	0.001	0.005
CCS 10K-6	KFP 15V20M	15	5	300x240x100	15	CFS 300-3	300	0.001	0.005
CCS 30K0.01	KFP 30V20M	30	10	400x300x128	30	CFS 3K-5	3000	0.01	0.05
CCS 30K0.1	KFP 30V20M	30	10	400x300x128	30	CFS 6K0.1	6000	0.1	0.1
CCS 60K0.01	KFP 60V20M	60	20	400x300x128	50	CFS 3K-5	3000	0.01	0.05
CCS 60K0.01L	KFP 60V20LM	60	20	500x400x137	50	CFS 3K-5	3000	0.01	0.05
CCS 60K0.1	KFP 60V20M	60	20	400x300x128	50	CFS 6K0.1	6000	0.1	0.1
CCS 60K0.1L	KFP 60V20LM	60	20	500x400x137	50	CFS 6K0.1	6000	0.1	0.1
CCS 150K0.01	KFP150V20M	150	50	500x400x137	150	CFS 3K-5	3000	0.01	0.05
CCS 150K0.01L	KFP150V20LM	150	50	650x500x142	150	CFS 3K-5	3000	0.01	0.05
CCS 150K0.1	KFP150V20M	150	50	500x400x137	150	CFS 6K0.1	6000	0.1	0.1
CCS 150K0.1L	KFP150V20M	150	50	650x500x142	150	CFS 6K0.1	6000	0.1	0.1
CCS 300K0.1	KFP300V20M	300	100	650x500x115	300	CFS 6K0.1	6000	0.1	0.1
CCS 300K0.01	KFP300V20M	300	100	650x500x115	300	CFS 3K-5	3000	0.01	0.05

2 Appliance overview

2.1 Counting scales KERN CFS

Model:
CFS 300-3

Models:
CFS 3K-5, CFS 6K0.1, CFS 15K0.2, CFS 30K0.5

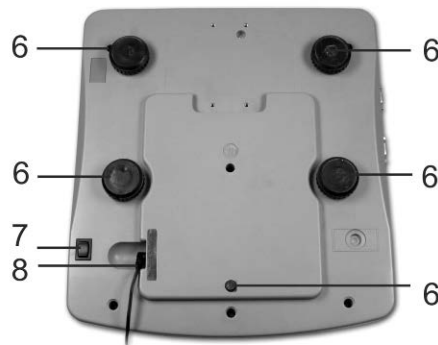

1. Weighing plate / rechargeable battery compartment (under weighing plate)
2. Windshield
3. Bubble level
4. RS 232 interface
5. Second balance interface
6. Footscrews
7. ON/OFF switch
8. Mains adapter connection

Model CFS 50K-3

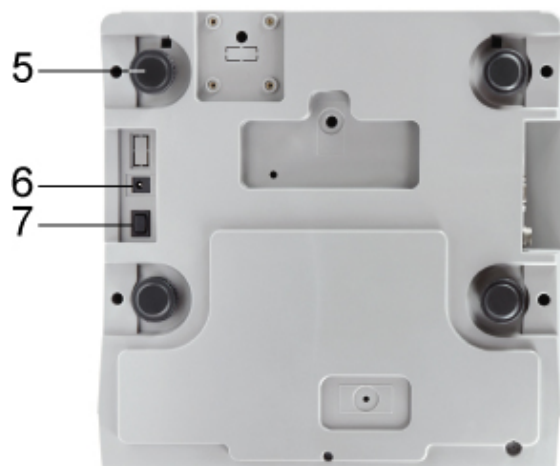

1. Weighing pan
2. Bubble level
3. RS 232 interface
4. Second balance interface
5. Footscrews
6. Connection of mains adapter
7. ON/OFF switch

2.2 Counting systems KERN CCS

i In factory the counting system **KERN CCS** is preconfigured in a way that no more changes will be necessary.



↑
Bulk material balance KERN KFP

↑
Reference balance KERN CFS

2.3 Counting systems with your selected bulk scales

i When attaching a bulk scales (not pre-adjusted by **KERN**), the following must be complied with:

- ⇒ Connect bulk scales with a suitable cable via the second-balance interface. Interface connection allocation cf. chapter 16
- ⇒ Adjustment of bulk scales, cf. chapter 13
- ⇒ Adjustment / linearisation of bulk scales, cf. chapter 14 / 15

Example 1: High-load bulk scales

Reference balance KERN CFS



Example 2: High-load reference scale



↑
Bulk material balance KERN KFP

↑
Reference scale KERN CFS 50K-3

2.4 Overview of display

Models CFS 300-3, CFS 3K-5, CFS 6K0.1, CFS 15K0.2, CFS 30K0.5:

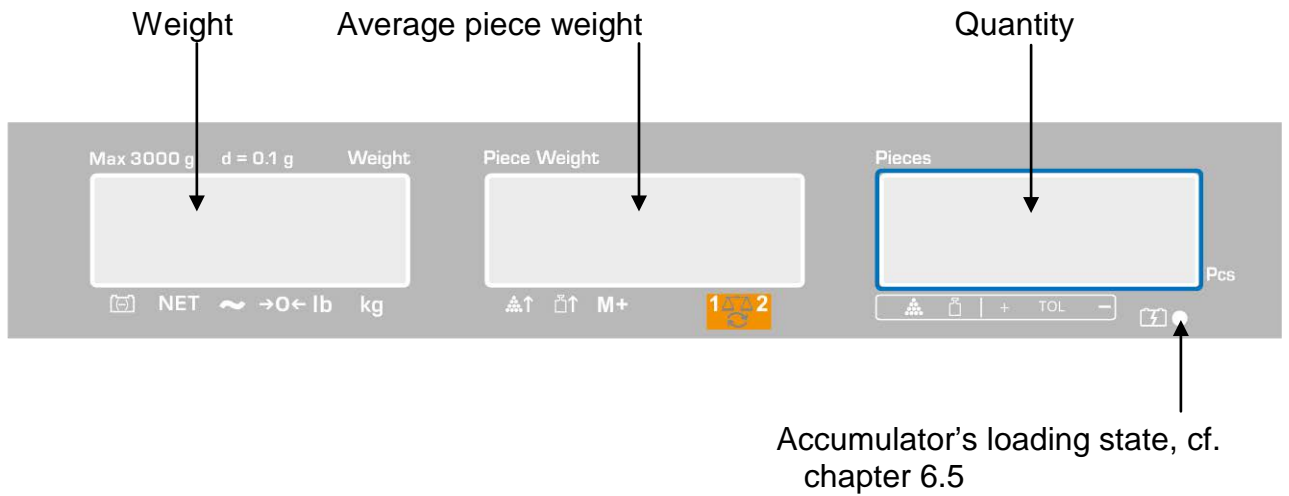

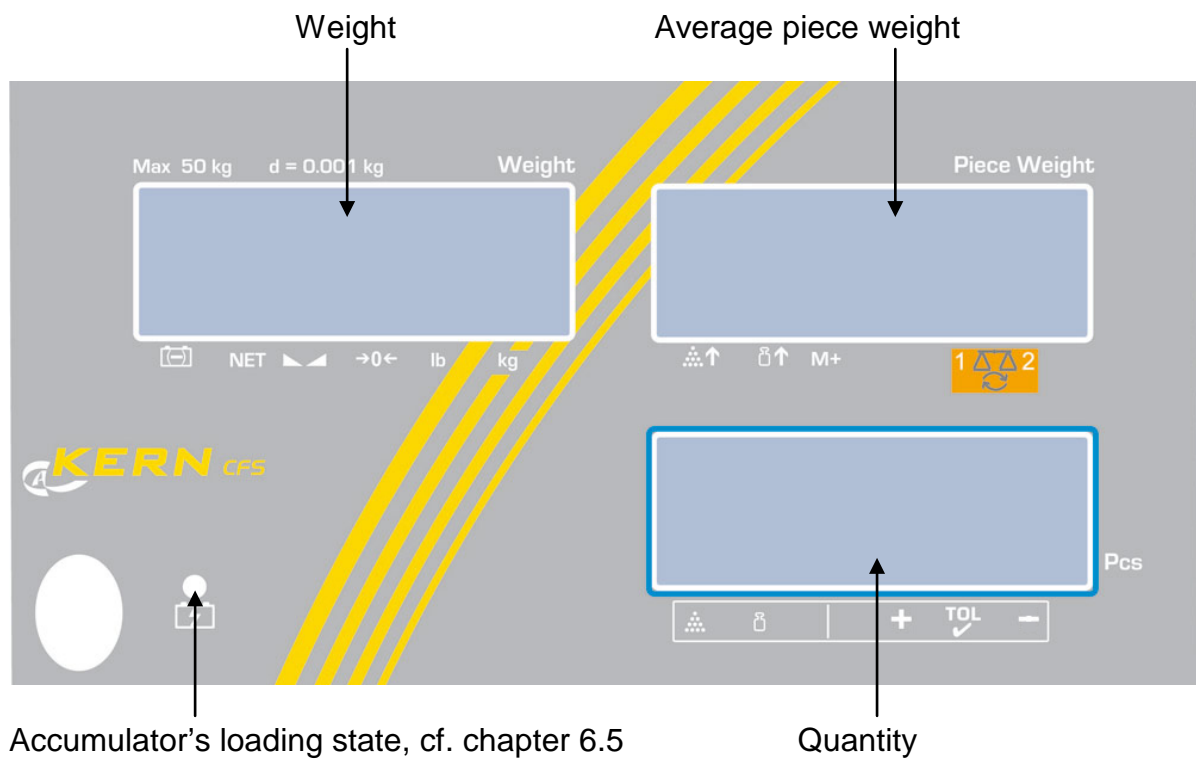

Model CFS 50K-3:



2.4.1 Display weight

Here the weight of your goods is displayed in [kg].



Indicator [▼] atop the symbol shows:

	Storage battery status display
NET	Net weight
	Stability state indication
 Model CFS 50K-3	
→0←	Zeroing display
lb/kg	Current weighing unit

2.4.2 Display average piece weight

Here the average reference weight of a sample is displayed in [g]. This value is either numerically entered by user or calculated by weighing on balance.



Indicator [▼] atop the symbol shows:

	Number of parts placed on balance too small
	Piece below minimum weight of piece
M+	Data in summation memory
	Active balance: 1. Reference balance KERN CFS 2. Bulk scales e.g. KERN KFP

2.4.3 Display quantity

Here the current piece quantity (PCS = pieces) or in totalizing mode the sum of the placed parts is displayed, see chapter 10







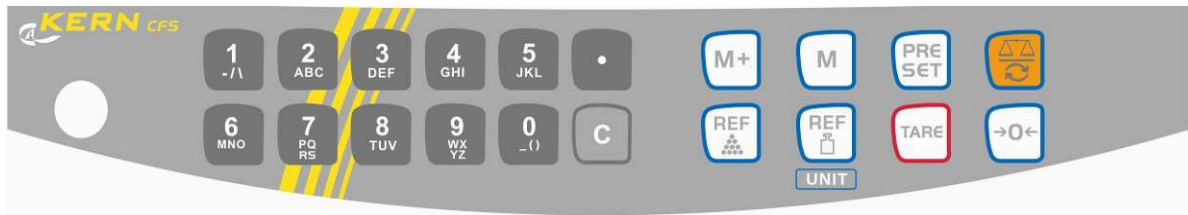

Indicator [▼] atop the symbol shows:

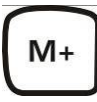

	Tolerance control in counting mode
	Tolerance control in weighing mode
+	Goods to be weighed above tolerance limit
TOL	Goods to be weighed within tolerance range
-	Goods to be weighed below tolerance limit

2.5 Keyboard overview

➤ Models CFS 300-3, CFS 3K-5, CFS 6K0.1, CFS 15K0.2, CFS 30K0.5

















Selection	Function in Weighing mode
	<ul style="list-style-type: none"> Numeric keys
	<ul style="list-style-type: none"> Decimal point At numeric input digit selection to the left
	<ul style="list-style-type: none"> Delete
	<ul style="list-style-type: none"> Totalization Display total weight /number of weighings / total quantity At numeric input digit selection to the right Data output (menu setting "AU OFF", see chapter 12.2)
	<ul style="list-style-type: none"> Store/call article, cf. chapters 11.1 / 11.2
	<ul style="list-style-type: none"> Fill-to-target function (cf. chapter 9)
	<ul style="list-style-type: none"> Switch-over balance, see chap. 7.3
	<ul style="list-style-type: none"> Input of the average piece weight by weighing, see chap. 8.1
	<ul style="list-style-type: none"> Numeric input of the average piece weight see chapter 8.2 Leafing through the menu
	<ul style="list-style-type: none"> Switch-over weighing unit

	<ul style="list-style-type: none"> • Taring • Confirm
	<ul style="list-style-type: none"> • Zeroing • Back to menu/weighing mode

➤ **Model CFS 50K-3:**



Selection	Function in Weighing mode
 	<ul style="list-style-type: none"> • Article direct keys, cf. chapter 11.3
 	<ul style="list-style-type: none"> • Numeric keys
	<ul style="list-style-type: none"> • Decimal point
	<ul style="list-style-type: none"> • Delete

	<ul style="list-style-type: none"> • Summing up / printing (menu adjustment "AU OFF", cf. chapter 12.2) • Display total weight /number of weighings / total quantity • Data output (menu setting "AU OFF", see chapter 12.2)
	<ul style="list-style-type: none"> • Fill-to-target function (cf. chapter 9)
	<ul style="list-style-type: none"> • Store/call article, cf. chapters 11.1 / 11.2
	<ul style="list-style-type: none"> • Switching over the scale, cf. chapter 7.3 • At numeric input digit selection to the left
	<ul style="list-style-type: none"> • Input of the average piece weight by weighing, see chap. 8.1 • Leaving through the menu
	<ul style="list-style-type: none"> • Numeric input of the average piece weight see chapter 8.2 • Switch-over weighing unit
	<ul style="list-style-type: none"> • Taring • Confirm
	<ul style="list-style-type: none"> • Zeroing • At numeric input digit selection to the right. • Back to menu/weighing mode

3 Basic instructions

3.1 Proper use

The balance / counting system you purchased is intended to determine the weighing value of material to be weighed. It is intended to be used as a “non-automatic balance”, i.e. the material to be weighed is manually and carefully placed in the centre of the weighing pan.. As soon as a stable weighing value is reached the weighing value can be read.

3.2 Improper Use

Do not use balance / counting system for dynamic weighing. In the event that small quantities are removed or added to the material to be weighed, incorrect weighing results can be displayed due to the “stability compensation“. (Example: Slowly draining fluids from a container on the balance.)

Do not leave permanent load on the weighing pan. This may damage the measuring system.

Impacts and overloading exceeding the stated maximum load (max) of the balance / counting system, minus a possibly existing tare load, must be strictly avoided. Balance may be damage by this.

Never operate balance / counting system in explosive environment. The serial version is not explosion protected.

The structure of the balance may not be modified. This may lead to incorrect weighing results, safety-related faults and destruction of the balance.

The scale / the counting system may only be used according to the described preconditions. Other areas of use must be released by KERN in writing.

3.3 Warranty

Warranty claims shall be voided in case

- Our conditions in the operation manual are ignored
- The appliance is used outside the described uses
- The appliance is modified or opened
- Mechanical damage or damage by media, liquids, natural wear and tear
- The appliance is improperly set up or incorrectly electrically connected
- The measuring system is overloaded

3.4 Monitoring of Test Resources

In the framework of quality assurance the measuring-related properties of the balance and, if applicable, the testing weight, must be checked regularly. The responsible user must define a suitable interval as well as type and scope of this test. Information is available on KERN's home page (www.kern-sohn.com) with regard to the monitoring of balance test substances and the test weights required for this. In KERN's accredited DKD calibration laboratory test weights and balances may be calibrated (return to the national standard) fast and at moderate cost.

4 Basic Safety Precautions

4.1 Pay attention to the instructions in the Operation Manual



- ⇒ Carefully read this operation manual before setup and commissioning, even if you are already familiar with KERN balances.
- ⇒ All language versions contain a non-binding translation. The original German is binding.

4.2 Personnel training

The appliance may only be operated and maintained by trained personnel.

5 Transport and storage

5.1 Testing upon acceptance

When receiving the appliance, please check packaging immediately, and the appliance itself when unpacking for possible visible damage.

5.2 Packaging / return transport



- ⇒ Keep all parts of the original packaging for a possibly required return.
- ⇒ Only use original packaging for returning.
- ⇒ Prior to dispatch disconnect all cables and remove loose/mobile parts.
- ⇒ Reattach possibly supplied transport securing devices.
- ⇒ Secure all parts such as the glass wind screen, the weighing platform, power unit etc. against shifting and damage.

6 Unpacking, Setup and Commissioning

6.1 Installation Site, Location of Use

The balances / counting systems are designed in a way that reliable weighing results are achieved in common conditions of use.

You will work accurately and fast, if you select the right location for your balance / counting system.

On the installation site observe the following:

- Place the balance / counting system on a firm, level surface;
- Avoid extreme heat as well as temperature fluctuation caused by installing next to a radiator or in the direct sunlight;
- Protect the balance against direct draughts due to open windows and doors;
- Avoid jarring during weighing;
- Protect the balance / counting system against high humidity, vapours and dust;
- Do not expose the device to extreme dampness for longer periods of time. Non-permitted condensation (condensation of air humidity on the appliance) may occur if a cold appliance is taken to a considerably warmer environment. In this case, acclimatize the disconnected appliance for ca. 2 hours at room temperature.
- Avoid static charge of goods to be weighed or weighing container.

Major display deviations (incorrect weighing results) may be experienced should electromagnetic fields (e.g. due to mobile phones or radio equipment), static electricity accumulations or instable power supply occur. Change location or remove source of interference.

6.2 Unpacking, Scope of delivery

Remove device and accessories carefully from packaging, remove packaging material and place device at the planned work place. Verify that there has been no damage and that all packing items are present.

6.2.1 Scope of delivery / serial accessories

KERN CFS

- Balance (see chap. 2.1)
- Power cable
- Protective cover
- Operating manual

KERN CCS

- Reference balance KERN CFS, see chap. 2.2
- Bulk material balance KERN KFP (see chap. 2.2)
- Operating instructions KERN CFS/CCS
- Operating instructions KERN KFP

6.3 Installing / removing transport fittings

⇒ Remove transport lock, if applicable.

KERN CFS 3K0.5, CFS 6K0.1:

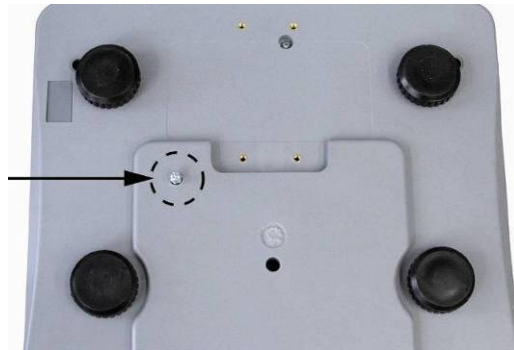

KERN CFS 300-3:

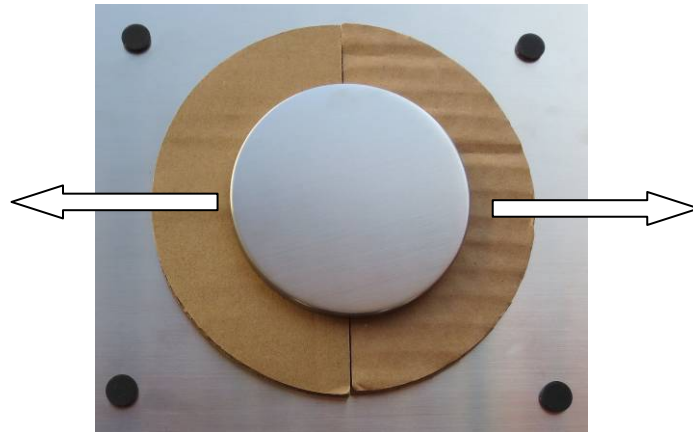

Bulk scales KERN KFP (illustration example):

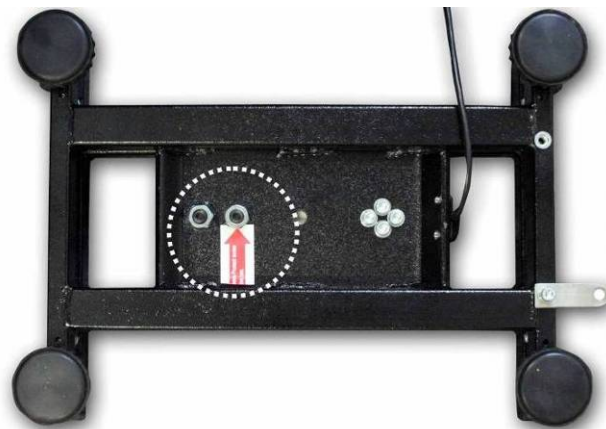

KERN KFP 6V20M, KFP 6V20LM, KFP 15V20M.

Please take further details from the installation manual, added to the platform.

- ⇒ Install weighing plate and wind screen, if applicable, if needed.
- ⇒ Level balance with foot screws until the air bubble of the water balance is in the prescribed circle.

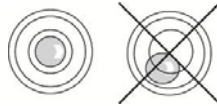

- ⇒ Check levelling regularly
- ⇒ Interconnect reference scale and bulk scales via the second-scale interface in the counting systems KERN CCS.

6.4 Mains connection

Power is supplied via the external mains adapter. The stated voltage value must be the same as the local voltage.

Only use original KERN mains adapters. Using other makes requires consent by KERN.

6.5 Rechargeable battery operation (optional)

The rechargeable battery is charged via the delivered power cable.

Before the first use, the rechargeable battery should be charged by connecting it to the mains power cable for at least 15 hours. The operation time of the rechargeable battery is approx. 70 hours. When connecting a second balance, the operation time will be reduced.

To save the rechargeable battery, in the menu (see chap.12.2) the automatic switch-off function [„F I OFF“ ⇒ „OFF „] can be activated, switch-off time selectable according to 0, 3, 5, 15, 30 minutes.

If an arrow appears on the weight display [▼] above the battery symbol  or "bat lo" when turning on the balance, this is an indication that the capacity of the rechargeable battery will soon be exhausted. The balance will be ready to operate for about another 10 hrs., then it will switch off automatically. Connect the power cable as soon as possible to load the rechargeable battery. Charging time until complete recharging is approx. 12h.

The LED display informs you during loading about the loading status of the rechargeable battery.

- red: Voltage has dropped below prescribed minimum. Connect mains adapter to load the rechargeable battery.
- green: Rechargeable battery completely reloaded
- yellow: Rechargeable battery very low. Connect mains adapter as soon as possible to load the rechargeable battery.

6.6 Connection of peripheral devices

Before connecting or disconnecting of additional devices (printer, PC) to the data interface, always disconnect the balance from the power supply.

With your balance, only use accessories and peripheral devices by KERN, as they are ideally tuned to your balance.

6.7 Initial Commissioning

In order to obtain exact results with the electronic balances, your balance must have reached the operating temperature (see warming up time chap. 1).

During this warming up time the balance must be connected to the power supply (mains, accumulator or battery).

The accuracy of the balance depends on the local acceleration of gravity.

Strictly observe hints in chapter Adjustment.

6.8 Adjustment

As the acceleration value due to gravity is not the same at every location on earth, each balance must be coordinated - in compliance with the underlying physical weighing principle - to the existing acceleration due to gravity at its place of location (only if the balance has not already been adjusted to the location in the factory).

This adjustment process must be carried out for the first commissioning, after each change of location as well as in case of fluctuating environment temperature. To receive accurate measuring values it is also recommended to adjust the balance periodically in weighing operation.

⇒ Procedure see chapter 14.

7 Basic Operation

7.1 Switching on/off



- ⇒ Actuate power switch (cf. chapter 2) at the right bottom of the scale to the front. The balance will carry out a self-test. As soon as the weight display appears, the balance is ready for weighing.
- ⇒ To switch-off push backward the switch-on/switch-out on the right lower side of the balance.

7.2 Zeroing

Resetting to zero corrects the influence of light soiling on the weighing plate. The resetting range of the balance was adjusted to $\pm 2\%$ max. by factory. Further adjustments are possible in the menu, see chapter 12.

When using as counting system the zeroing range of both balances can be set in the menu, see chapter 13.

Manual

- ⇒ Unload the balance
- ⇒ Press , the balance starts resetting to zero. The [] symbol over a appears.

Automatic

In the menu the automatic zero point correction can be switched off or the amount can be changed, see chapter 13.

7.3 Switching over reference scale ↔ bulk scales if used as counting system

For piece counting a platform can be connected via the second balance interface. In the counting system KERN CCS the quantity counting is made on the bulk material balance KERN KFP. The reference balance KERN CFS permits due to its high resolution a very precise determination of the average piece weight.

The second balance can be operated in the same manner like the first balance.

By pressing  the display changes from one to the other balance.

In the display appears *CHAnGE rEnoTE* or *CHAnGE LoCAL*.

The appeared [] displays the active balance.

Display example model CFS 6K0.1:



(1) Reference balance **KERN CFS**



(2) Bulk scales,
e.g.: KERN KFP with
counting system KERNCCS



7.4 Weighing with tare

A tare value can be entered for the reference as well as for the bulk material balance. Before setting a tare value select active balance, see chap. 9.3.

7.4.1 Taring

- ⇒ Deposit weighing vessel. After successful stop check press the **TARE** button. Zero display and the indicator [▼] above **NET** appear. The weight of the container is now internally saved.
- ⇒ Weigh the material, the net weight will be indicated.
- ⇒ After removing the weighing container, the weight of the weighing container appears as negative display.
- ⇒ To delete the tare value, remove load from weighing pan and press the **TARE**-key.
- ⇒ The tare procedure can be repeated as many times as necessary, for example with initial weighing of several components for a mix (add-on weighing). The limit is reached when the total weighing range capacity is full.

7.4.2 Numeric entering of tare weight

- ⇒ Unload and reset to zero the balance.
- ⇒ Input known tare weight via the numeric keys with decimal point, and confirm with **TARE** key. The entered weight will be stored as tare weight and displayed with negative sign. The indicator [▼] above **NET** appears.
- ⇒ Put the filled weighing container on the balance, the net weight will be displayed.
- ⇒ The tare value remains stored until it is deleted with the **TARE** key.



The tare value will be rounded up according to the readability of the balance, e.g. at a balance 60 kg max/5 g readability the input value of 103 g will be displayed as -105 g.

7.4.3 Switch-over weighing unit

Depending on the model, pressing the **UNIT** key may switch over between g / kg ⇔ lb (only with menu adjustment F1 oFF→Unit→ kg / lb).

The indicator [▼] shows the active unit.



8 Parts counting

Before the balance can count parts, it must know the average part weight (i.e. reference). Proceed by putting on a certain number of the parts to be counted. The balance determines the total weight and divides it by the number of parts, the so-called reference quantity. Counting is then carried out on the basis of the calculated average piece weight.

As a rule:



The higher the reference quantity the higher the counting exactness.



- ⇒ The average piece weight can only be determined by stable weighing values.
- ⇒ If weighing values are under zero, the piece counter display shows a negative number of items.
- ⇒ The precision of the average unit weight can be increased at any time while units are being counter by inputting the displayed number of units and confirming by  or  (in CFS 50K-3 models). After the reference optimization sounds a signal tone. As the additional pieces increase the base for the calculation, the reference also becomes more exact.

8.1 Determination of the average piece weight by weighing

Set reference

- ⇒ Reset balance to zero or tare the empty weighing container if necessary.
- ⇒ Place on the weighing plate a known number (e.g. 10 items) of individual pieces as a reference.
Input the number of reference pieces via the number keys.
Wait for stability display and confirm with  or  (model CFS 50K-3) within 5 sec.

The scale shall detect the average piece weight and will then display the number of pieces.

Display example model CFS 6K0.1:

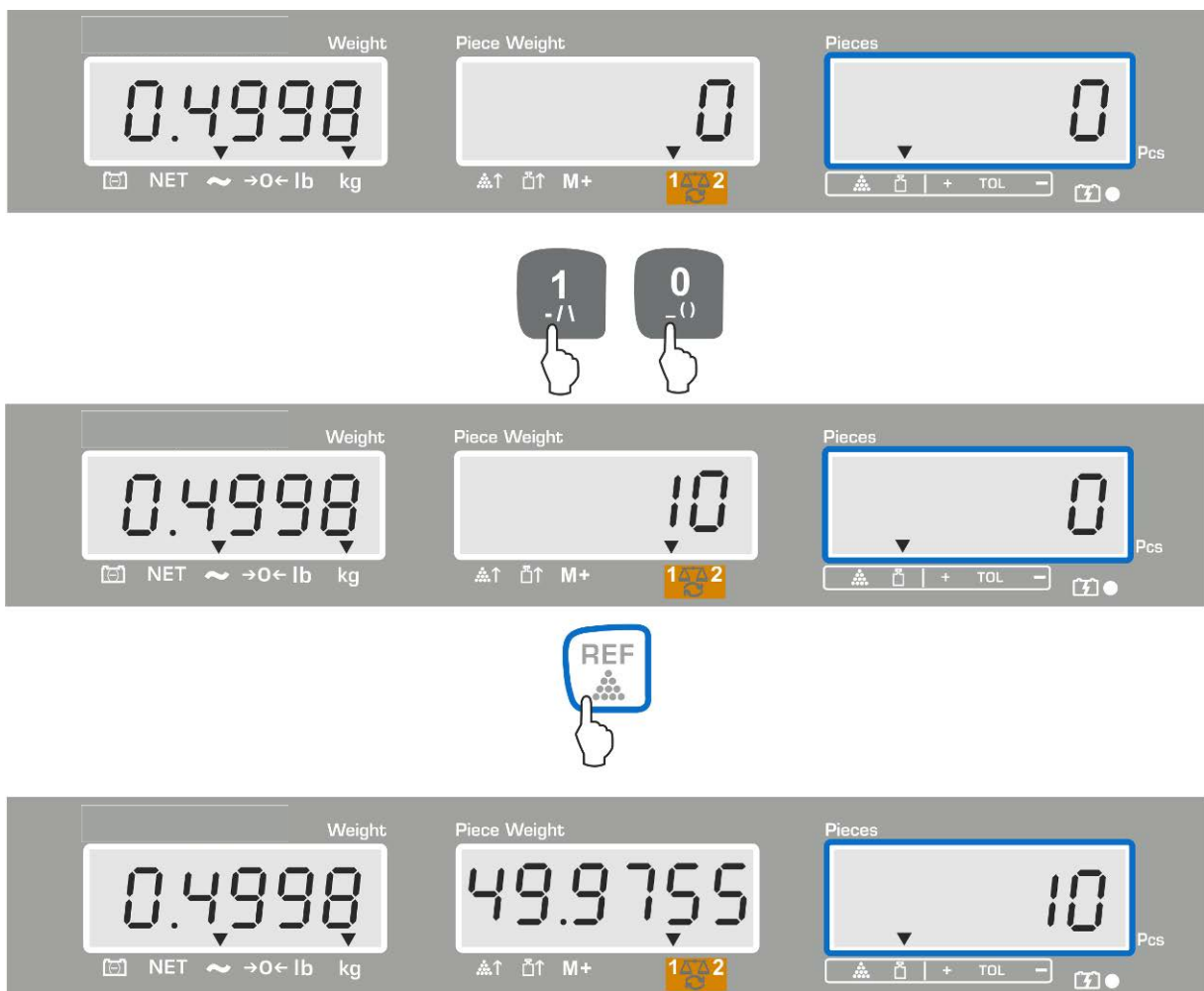

Display example model CFS 50K-3:

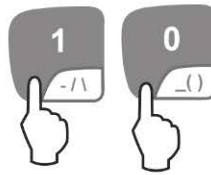
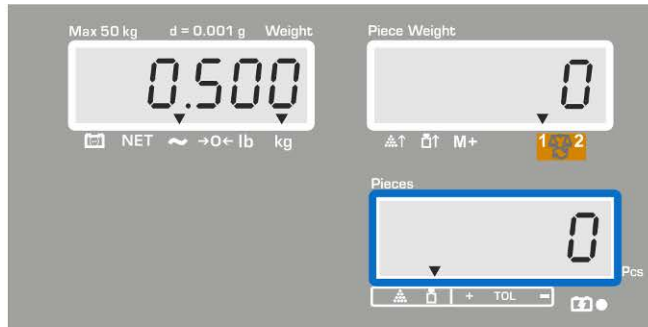

Count the items

⇒ Tare if necessary, place weighing good and read off the number of items.

Display example model CFS 6K0.1:



Display example model CFS 50K-3:



Interconnecting an optional printer, the display value will be output by pressing  (menu adjustments F1 OFF ⇒ ACC off; F2 Prt ⇒ P mode Print ⇒ Au OFF, cf. chapter 14.2).

Printout example KERN YKB 01N / CFS 6K0.1:

S1	Active balance, see chap. 7.3
ID: 123456	User identification number (cf. chapter 12.2)
N 2.4986 kg	Net weight
49.9755 g/pcs	Average piece weight
50 pcs	Quantity

 Further printout examples cf. chapter 17.2.



Delete average piece weight

⇒ Press 

8.2 Numeric input of the average piece weight

Set reference

⇒ Input known average piece weight, e.g. 10 g, with the numeric keys and confirm

with  or  (models CFS 50K-3) within 5 sec.

If in the weight display as weighing unit [kg] is active, the average piece weight will be displayed in [g]. If as weighing unit [lb] is active, the average piece weight is also displayed in [lb].

Display example model CFS 6K0.1:

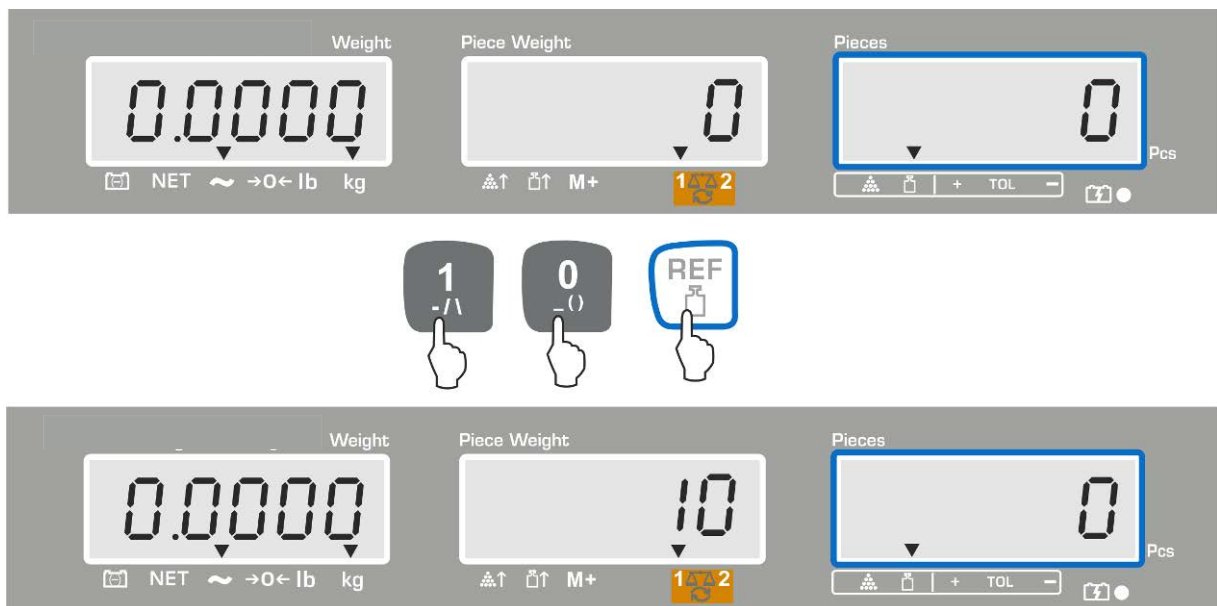

Display example model CFS 50K-3:

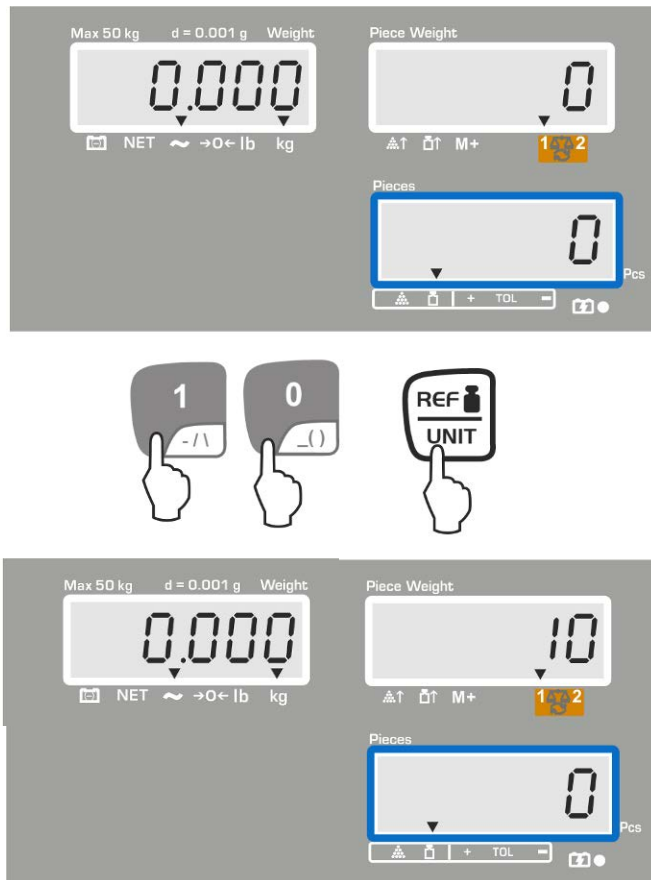

Count the items



⇒ Tare if necessary, place weighing good and read off the number of items.

Interconnecting an optional printer, the display value will be output by pressing , display and printout examples cf. chapter 10.1.



Delete average piece weight

⇒ Press 

8.3 Automatic reference optimization

If at the reference determination the placed weight or the placed piece number is too small, in the display of the average piece weight the triangle symbol will appear over [] or [].

To optimize the calculated average piece weight automatically, add further parts whose number is smaller than that of the first reference determination. After the reference optimization sounds a signal tone. For each reference optimization the average piece weight is newly calculated. As the additional pieces increase the base for the calculation, the reference also becomes more exact.

Pressing  or  (models CFS 50K-3), recalculation can be prevented and the reference weight can thus be blocked.

Automatic reference optimization will be deactivated as soon as the number of added parts exceeds the saved reference quantity.

8.4 Counting with counting system



(Illustration example)



Bulk material balance e.g. KERN KFP

- Here pieces of huge quantities will be counted.
- Big parts (max > 3kg) are counted on the platform.
- If in the determination of the average piece weight no such high resolution is asked for as that of the **KERN CFS**, the reference formation can also be made in the bulk material balance.



Reference balance KERN CFS

- Due to its high resolution it is useful for accurate determination of the average piece weight.
- Smallest parts (max < 3kg) are counted on the precise **KERN CFS**.

Counting with bulk material balance:

1. On the reference balance **KERN CFS** set average piece weight, see chap. 8.1. or chap. 8.2.
2. Switch over balance with  (see chap. 7.3)
3. Put empty container onto bulk scales' weighing plate and tare.
4. Fill counted quantity in the vessel on the bulk material balance. The piece number is shown in the display.

Display example model CFS 6K0.1:



load 5 kg

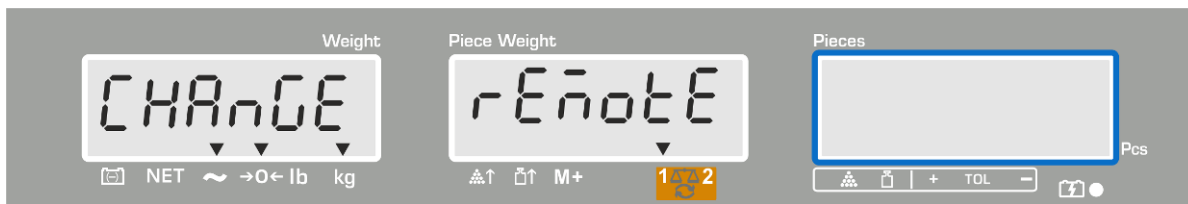

In order to avoid errors at the piece number determination, both balances must be adjusted with the same acceleration due to gravity (see chap. 14). In case of non-compliance counting errors will result!

9 Fill-to-target function

The balance allows weighing of goods to a certain target weight or target piece number within defined tolerances. With this function one can also check if the weighing good is within a defined tolerance range. Tolerance control is possible in weighing or target mode.

Reaching the target value is indicated by an acoustic (if activated in menu) and an optic signal (tolerance mark ▼).

Audio signal:



The acoustic signal is dependent of the adjustment in the menu block „F1 oFF→BEEP“.

Options:



bEEP off	Acoustic signal turned off
bEEP on in	Acoustic signal sounds if the weighted piece is within the given tolerance
bEEP on out	Acoustic signal sounds if the weighted piece is outside the given tolerance

Optical signal:

The tolerance marker ▼ provides the following information:

	Target number /target weight exceeds given tolerance
	Target number /target weight within given tolerance
	Target number /target weight below given tolerance

9.1 Tolerance check for target weight

- ⇒ Press , the active tolerance weighing mode is indicated.
- ⇒ If needed, select tolerance control for target weight (PSt nEt) with  or  (models CFS 50K-3).

Display example model CFS 6K0.1:



- ⇒ Press the **TARE** key, which shows the currently set upper threshold.
- ⇒ To change, input desired value, e.g. 5.500 kg with the numeric keys.



- ⇒ Confirm with **TARE** key; the currently adjusted minimum threshold will be displayed.
- ⇒ To change, input desired value, e.g. 5,0000 kg with the numeric keys.



- ⇒ Confirm with **TARE** key, the tolerance control will start. The indicator [▼] above  appears.

⇒ Put on the weighed material and check whether the weighed material is within the given tolerance, alongside the tolerance mark ▼ / acoustic signal.

Display of tolerance mark ▼, if weighing goods are under the specified tolerance:



Display of tolerance mark ▼, if weighing goods within the specified tolerance:



Display of tolerance mark ▼, if weighing goods above the specified tolerance:





- i**
 - For tolerance control, also only one limit value can be set.
 - If both limit values are deleted, the tolerance control is deactivated.
 - Delete limit values:

When inputting the upper and lower threshold press  and confirm with the **TARE**-key.

9.2 Tolerance check for target quantity

⇒ Press , the active tolerance weighing mode is indicated.

⇒ If needed, select tolerance control for target weight (PSt nEt) with  or  (models CFS 50K-3).

Display example model CFS 6K0.1:



⇒ Press the **TARE** key, which shows the currently set upper threshold.

⇒ To change, input the desired value, e.g. 100 pieces, with the numeric keys.



⇒ Confirm with **TARE** key; the currently adjusted minimum threshold will be displayed.

⇒ To change, input the desired value, e.g. 90 pieces, with the numeric keys.



⇒ Confirm with **TARE** key, the tolerance control will start. The indicator ▼ above  appears.

⇒ Determine the average piece weight (see chap. 10.1 or 10.2), place the weighing goods and check using the tolerance mark ▼, if the number of the placed pieces is under, within or above the specified tolerance.

Display of tolerance mark ▼, if weighing goods are under the specified tolerance:



Display of tolerance mark ▼, if weighing goods within the specified tolerance:



Display of tolerance mark ▼, if weighing goods above the specified tolerance:



- For tolerance control, also only one limit value can be set.
- If both limit values are deleted, the tolerance control is deactivated.
- Delete limit values:



When inputting the upper and lower threshold press  and confirm with the **TARE**-key.

10 Totalization

Tolerance control is possible in weighing or target mode.

When using in the counting system, no matter, if the weighed goods are on the reference or on the bulk material balance.

Preparing:

- ⇒ When using as counting system select using  the balance, on which will be totalized. The appeared  displays the current balance.
- ⇒ When totalizing in counting mode set the average piece weight.
(see chap. 8.1 or 8.2)
- ⇒ If necessary, tare the empty balance container.

10.1 Manual totalizing



With this function the individual weighing values are added into the summation memory by pressing  and edited, when an optional printer is connected.





- Menu settings:
 - „F1 off“ ⇒ „ACC“ ⇒ „ON“ (unavailable in model CFS 50K-3)
 - „F2 Prt“ ⇒ „P mode“ ⇒ „Print“ ⇒ „Au OFF“ (cf. chapter 12.2)
- When using as counting system there can be totalized on the reference as well as on the bulk material balance.
Before the totalizing process select the active balance, see chap. 7.3.

Add up:

- ⇒ Place weighing goods **A**.

Wait until stability display is displayed, then press  or  (models CFS 50K-3). The weight value or number will be stored and be output if connected to an optional printer.

- ⇒ Remove the weighed good. More weighed goods can only be added when the display \leq zero.
- ⇒ Place goods to be weighed **B**.

Wait until stability display is displayed, then press  or  (models CFS 50K-3). The weight value or the number of items are added in the summation memory and printed out. Total weight, number of weighing procedures as well as total parts counting appear 2 sec.

- ⇒ Add more weighed goods as described before. Please note that the balance must be unloaded between the individual weighing procedures.

⇒ This process can be repeated 99 times or until the weighing range of the balance is exhausted.

Display of the saved weighing data:

⇒ Press , the total weight, weighing number, and total number of pieces will be displayed and be output if connected to an optional printer.

Display example model CFS 6K0.1:

Total weight placed on balance: Number weighing processes. Total number of pieces:



Printout example KERN YKB-01N:



S 1	
ID:	123456
C	

No.	2
C	4.9975kg
C	500 pcs



Active balance, see chap. 7.3
 User identification number (cf. chapter 12.2)
 Number weighing processes
 Total weight
 Total number of pieces

i Further printout examples cf. chapter 17.2.

Delete weighing data:

⇒ Press  or  (models CFS 50K-3), so that the total weight, weighing number, and total number of pieces will be displayed. During this display press . The data in the summation memory are deleted.

10.2 Automatic adding-up

This function is used to add up the individual weighing values automatically into the sum storage once the scale is relieved, without pressing  or  (models CFS 50K-3); and edited if interconnected to an optional printer.

- Menu settings:
„F1 off“ ⇒ „ACC“ ⇒ „ON“ (unavailable in model CFS 50K-3)



„F2 Prt“ ⇒ „P mode“ ⇒ „Print“ ⇒ „Au ON“, cf. chapter 12.2

- When using as counting system there can be totalized on the reference as well as on the bulk material balance.
Before the totalizing process select the active balance, see chap. 7.3.

Add up:

- ⇒ Place weighing goods **A**.
After the standstill control sounds a signal tone. Unload the weighing good, the weighing value is added into the summation memory and printed out.
- ⇒ Place goods to be weighed **B**.
After the standstill control sounds a signal tone. Unload the weighing good, the weighing value is added into the summation memory and printed out.
- ⇒ Add more weighed goods as described before. Please note that the balance must be unloaded between the individual weighing procedures.
- ⇒ This process can be repeated 99 times or until the weighing range of the balance is exhausted.





Display and deletion of the weighing data, and printout example
cf. chapter 10.1.

11 Store article information

The scale has more than 100 article storage places for frequently used tare values, average piece weights and article names.

These data can be accessed by calling up the corresponding number of a certain article.

Model CFS 50K-3 is additionally provided with 5 direct keys  ~ , cf. chapter 11.3).

11.1 Store article

Preparation:

- ⇒ If necessary set balance to zero using .
- ⇒ Tare if using a weighing container.

In case of counting systems, consider whether bulk scales or counting scale should be tared. Select bulk material or reference balance accordingly by . The displayed [▼] shows the active type of scale, cf. chapter 7.3.

Either put on weighing container and tare with TARE key (cf. chapter 7.4.1.) or numerically input tare value (cf. chapter 7.4.2).

Tare values can only be saved when they are situated in the admitted taring range (factory setting > 2 % max).

At values < 2 % max, reset balance with .

- ⇒ If used as a counting system select reference balance using .
- ⇒ Either detect average piece weight (e.g. 10 g) by weighing (cf. chapter 8.1) or input numerically (cf. chapter 8.2).

Store article:

⇒ Press  to input the storage place number (e.g. number 27)

Display example model CFS 6K0.1:



⇒ Input „2“ and „7“ with the numeric keys.



⇒ Press , the currently stored article name will be displayed. The first digit is flashing.

⇒ Delete by , if necessary, and overwrite with new article name as described below (no more than 12 characters, e.g. „KERN 1234 AB“).

For input of numbers, actuate shortly the numeric button.

For input of letters press the numeric button and keep it pressed until the desired letter is displayed. The characters according to keyboard assignation run through.

1	- / \
2	A B C
3	D E F
4	G H I
5	J K L
6	M N O
7	P Q R S
8	T U V
9	W X Y Z
0	_ [] _ = Space

Overview data input / data output:

A	B	C	D	E	F	G	H	I	J	K	L	M	N	O	P	Q	R	S	T	U	V	W	X	Y	Z	-	/	\	()
R	b	[d	E	F	G	H	,	U	T	L	n	n	o	P	o	r	S	t	U	u	ü	Ë	Y	Z		,	'	[]

Use  to move number selection to the left, the respective active position flashes.

Use  to move the number selection to the right, the respective active position flashes.

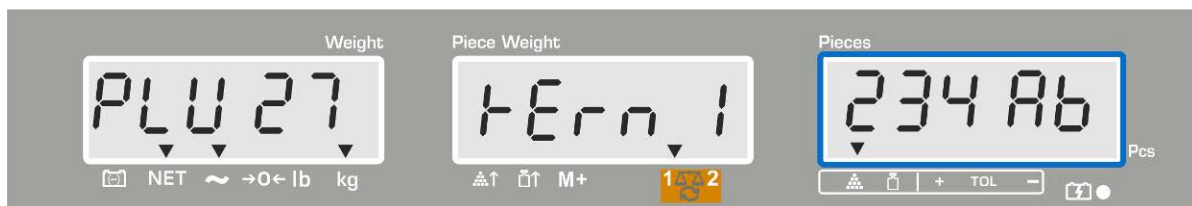

- Confirm input by . The data (tare value, average piece weight, article designation) are stored under the entered PLU-number; the data can be called-up at any time by calling the respective PLU-number.

i Article information may also be stored and called via the RS232 interface, cf. chapter 17.3.5 (unavailable in model CFS 50-3K)

11.2 Call article

⇒ When using as counting system use  to select the balance, on which the tare value is stored. The appeared [▼] displays the current balance.

⇒ Press ; „PLU“ to input the storage place number will show.



⇒ Call desired number, e.g. 27; press numeric keys „2“ and „7“ to this end.

⇒ Press  again, the storage place number (e.g. PLU 27) and the article name will be shown for 1 second.

If the data shall be displayed longer time, keep  pressed.

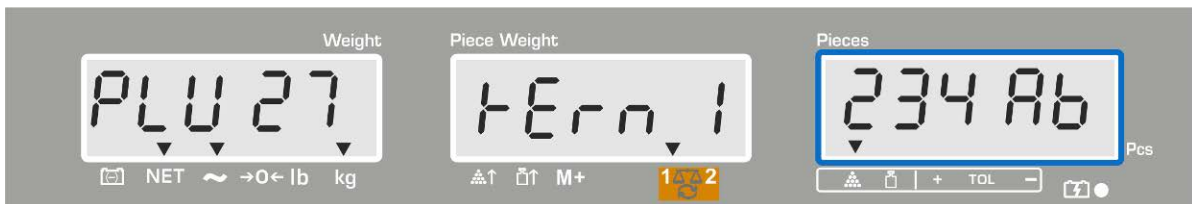

The display changes into the counting mode, the stored tare value e.g. 500 g and the average piece weight e.g. 10g /pce. are displayed.



⇒ Place load on pan and read the number of pieces.

⇒ When connecting an optional printer, the data can be edited by pressing 

Printout example KERN YKB-01N:

S 1	Active balance, see chap. 7.3
ID: 123456	User identification number (cf. chapter 12.2)
KERN 1244 AB	Article name (cf. chapter 11.1)
N. 1.9990 kg	Placed net weight
10 g/pcs	Average piece weight
200 pcs	Quantity placed on balance

 Further printout examples cf. chapter 17.2.

11.3 Article direct keys  ~  (only model CFS 50K-3)

1. Preparation, cf. chapter 11.1
2. Store article

⇒ Press desired direct key e.g.  for approx. 3 seconds, storage place „1“ and the currently stored article name will be shown. The first digit is flashing.

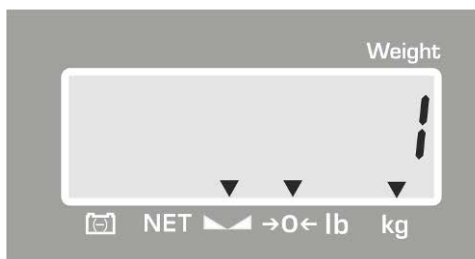

⇒ Input article name as described in chapter 11.1 (no more than 12 characters)



⇒ Confirm input by . The data (tare value, average piece weight, article name) will be stored under the selected direct key.

3. Call article

- ⇒ Press direct key e.g. 1; the storage place number and the article name will be shown for 1 second.



The display changes into the counting mode, the stored tare value e.g. 500 g and the average piece weight e.g. 10g /pce. are displayed.

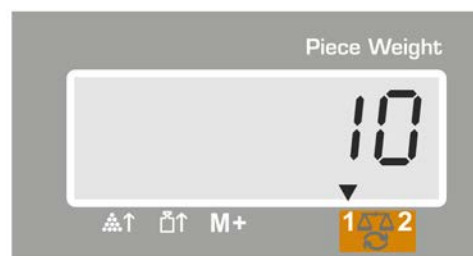

- ⇒ Place load on pan and read the number of pieces.
- ⇒ If connected to an optional printer, the data will be added up into the sum storage and edited by pressing M+.

Printout example CFS 50K-3 / KERN YKB 01N:

LOCAL SCALE	Active balance, see chap. 7.3
ID: 123456	User identification number (cf. chapter 12.2)
ABCDEF	Article name
1.9990 kg NET	Placed net weight
10 g U.W:	Average piece weight
200 pcs	Quantity placed on balance
TOTAL	













1.9990 kg NET	Total weight
200 pcs	Total number of pieces
1 NO	Number weighing processes

12 Menu



The menu is structured in the following menu blocks.

1. *F1oFF* Balance settings
2. *F2PrE* Settings serial interface
3. *UId* Input/display user identification number
4. *SCId* Input/display scale identification number
5. *EECH* Configuration of bulk scale

12.1 Navigation in the menu

Call up menu	<p>⇒ Switch-on balance and during the selftest press . The first menu block <i>F1oFF</i> is displayed.</p>
Select menu block	<p>⇒ With  or  (model CFS 50K-3) the separate menu items can be accessed in succession.</p> <p><i>F1oFF</i> ⇒ <i>F2PrE</i> ⇒ <i>UId</i> ⇒ <i>SCId</i> ⇒ <i>EECH</i> ⇒ <i>F1oFF</i></p>
Select menu item	<p>⇒ Confirm selected menu block with TARE. The first menu item is displayed, e.g. <i>F1oFF</i> ⇒ <i>bEEP</i></p> <p>⇒ With  or  (model CFS 50K-3) the separate menu items can be accessed in succession.</p>
Select setting	<p>⇒ Confirm selected menu point with TARE. The current setting will be displayed.</p>
Change settings	<p>⇒ With  or  (model CFS 50K-3) switch over to the available settings.</p>
Acknowledge setting / exit the menu	<p>⇒ Press , balance will return to submenu</p> <p>⇒ Either make further adjustments in the menu or return to the menu with  or  (model CFS 50K-3).</p>
Return to weighing mode	<p>⇒ Press  or  (model CFS 50K-3) again</p>

12.2 Menu overview

Menu block Main menu	Menu item Submenu	Available Settings	Explanation
F1 OFF	bEEP	"bEEP" "off"	Signal tone switched off
		"bEEP" "on in"	Signal tone on, if weighing value within tolerance limits
		"bEEP" "on out"	Signal tone on, if weighing value outside tolerance limits
	EL resp. bt (model CFS 50K-3)	"LITE" "off"	Display background illumination off
		"LITE" "on"	Display background illumination on
		"LITE" "AUT"	Background illumination switches on automatically when loaded or a button is pressed
	Unit	"Unit" "kg/lb"	Weighing unit, switch over by  between kg ⇔ lb by
		"Unit" "kg"	Weighing unit "kg"
		"Unit" "lb"	Weighing unit "lb"
	OFF	0/3/5/15/30	Auto-off function, balance will switch off automatically after the set time. Selectable 0/3/5/15/30 minutes.
	"ACC" (unavailable in model CFS 50K-3)	"ACC" "on"	Totalizing mode on
"ACC" "off"		Totalizing mode off	
F2 Prt	Prnt	"AU off"	Data output of stable weighing values after pressing 
		"AU on"	Automatic data output of stable weighing values after unloading the balance
			Remote control commands models CFS 6K0.1, CFS 15K0.2, CFS 30K0.5, CFS 50K-3
	AST	Remote control commands model CFS 300-3, CFS 3K-5	
	P Cont	Continuous data output of all weighing data, (totalizing deactivated)	
	P SER r E	Continuous data output only weight value	

	P BAUD	b 600	Baud rate 600
		b 1200	Baud rate 1200
		b 2400	Baud rate 2400
		b 4800	Baud rate 4800
		b 9600	Baud rate 9600
	PARITY	8 n 1	8 bits, no parity
		7 E 1	7 bits, even parity
		7 o 1	7 bits, odd parity
	P TYPE	LPUP	Standard printer setting
		LP50	Not documented
	P Forñ (not available in models CFS 300-3 CFS 3K-5 CFS 50K-3)	Forñ 1	Data output format
		Forñ 2	For printout sample see chapter 17.2
		Forñ 3	
	U id	"U id"	Input/display user identification number, max. 6 digits
	SC id	"SC id"	Input/display scale identification number max. 6 digits
EECH	Details s.Chap. 13	configuration menu (password protected)	

13 Configuration of bulk scale



⇒ Changes may only be carried out by trained specialized personnel.











Ex factory, the scales **KERN CFS** respectively counting systems **KERN CCS** have been programmed such that no changes are generally necessary.

But if there are special conditions of use or if as bulk material balance an other weighing bridge (not preconfigured by **KERN**) is connected, in the menu block "EELH" the required settings can be made.













Technical data

Supply voltage:	5 VDC
Max. signal voltage	0-20 mV
Zeroing range	0-5 mv
Sensitivity	> 0.02 μ v
Resistance parameter	87 Ω Min., 4 x 350 Ω load cell
Connection	4 poles
Max. cable length	6 meter
Connection plug	9 pin d-subminiature bushing

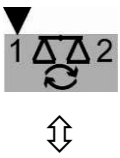















Navigation in the menu:













- ⇒ With  or  (model CFS 50K-3), the individual menu items may be selected one by one.
- ⇒ Confirm selected menu item with  or  (model CFS 50K-3). The current setting will be displayed.
- ⇒ With  bzw.  (model CFS 50K-3) switch over to the available settings.
- ⇒ Either save with  bzw.  (model CFS 50K-3) or reject with  or  (model CFS 50K-3).

Menu settings:

<p>Call up menu</p> <p>⇒ Switch-on balance and during the selftest press . The first menu block <i>F1 oFF</i> is displayed.</p>	<p>„F1 oFF“</p>
<p>⇒ Press repeatedly  or  (in CFS 50K-3 models) press again until <i>tECH</i> is displayed. <i>F1 oFF</i> ⇒ <i>F2 Prt</i> ⇒ <i>U id</i> ⇒ <i>SC id</i> ⇒ <i>tECH</i></p>	<p>„tECH“</p>
<p>⇒ Acknowledge with . The request to enter the password appears.</p>	<p>„Pin“</p>
<p>⇒ Or as standard password enter four times zero "0000" or the stored password (input see parameter). (Emergency password „9999“)</p> <p>⇒ Acknowledge by .</p>	<p>„Pin“ „----“</p>
<p>⇒ Select bulk scales „tECH“ „rEmotE“ with .</p> <p>⇒ Acknowledge with .</p>	<p>„tECH“ „LoCAL“</p> <p></p> <p>„tECH“ „rEmotE“</p> <p></p>
<p>⇒ Select the weighing unit [kg or lb] with  or  (model CFS 50K-3), where the adjustments shall be made. The appeared  displays the current weighing unit. Confirm with ; the next menu item „Cnt“ will be displayed.</p>	<p>„tECH“ „Unit“</p> <p>↓</p> <p>„Cnt“</p>

(1) **Adjusting the bulk scales, all models except for CFS 50K-3**

















<p>1. Internal resolution</p> <p>⇒ Press , the internal resolution will be shown.</p> <p>Return to menu by .</p> <p>Use  to select the next menu item „Cap“.</p>	<p>„Cnt“</p>
<p>2. Position decimal point / capacity</p> <p>⇒ Press  on display „CAP“; the currently adjusted position of the decimal point will be displayed.</p> <p>Select desired setting with  and acknowledge by .</p> <p>The currently set capacity is displayed.</p> <p>Delete with  for changes, and input desired value with the numeric keys.</p> <p>Confirm input with , the balance returns to the menu.</p> <p>⇒ Select the next menu point „div“ with .</p>	<p>„CAP“</p> <p>↓</p> <p>„dESC“ „0.00“</p> <p>↓</p> <p>„SEL“ „000030“</p> <p>↓</p> <p>„CAP“</p>
<p>3. Readability</p> <p>⇒ Press , the current setting will be displayed.</p> <p>Select desired setting by  and confirm with , the balance returns to the menu.</p> <p>⇒ Select the next menu point „AZt“ with .</p>	<p>„div“</p> <p>↓</p> <p>„inC“ „1“</p> <p>↓</p> <p>„div“</p>
<p>4. Automatic zero tracking on display change</p> <p>⇒ Press , the current setting will be displayed.</p> <p>Select desired setting by  and confirm with , the balance returns to the menu.</p> <p>⇒ Select the next menu point „0 AUto“ with .</p>	<p>„AZt“</p> <p>↓</p> <p>„AZn“ „2d“</p> <p>↓</p> <p>„AZt“</p>













<p>5. Zero adjustment range Range of loads in which the display will be set to zero after activation.</p> <p>⇒ Press  on display „0 AUto“; the current adjustment will be shown.</p> <p>Select desired setting by  and confirm with , the balance returns to the menu.</p> <p>⇒ Select the next menu point „0 manl“ with .</p>	<p>„0 AUto“</p> <p>Adjustments are only possible on the reference scale.</p>
<p>6. Manual zero tracking Range of loads in which the display will be set to zero after actuation of the zero key.</p> <p>⇒ Press , the current setting will be displayed.</p> <p>Select desired setting by  and confirm with , the balance returns to the menu.</p> <p>⇒ Select next menu point „Pin“ with .</p>	<p>„0 mAnL“</p> <p>↓</p> <p>„0 mAnL“ „2“</p> <p>↓</p> <p>„Pin“</p>
<p>7. Password for menu access „tECH“</p> <p>⇒ Press  and input new password with numeric keys. Confirm with  and repeat password input.</p> <p>⇒ Confirm with , the scale will return to its menu. On successful input, „donE“ will be displayed; „FAIL“ will be displayed on faulty input. Repeat input in this case.</p> <p>⇒ Select the next menu point „GrA“ with .</p>	<p>„Pin“</p> <p>↓</p> <p>„Pin1“ „----“</p> <p>↓</p> <p>„Pin2“ „----“</p> <p>„donE“</p>
<p>8. Local gravitation constant</p>	<p>„GrA“</p> <p>Not documented</p>



Adjustment or linearization must be done after configuration.
Implementation of adjustment cf. chapter 14 / linearization cf. chapter 15.

(2) **Adjustment of bulk scales, model CFS 50K-3**

<p>1. Internal resolution</p> <p>⇒ Press , the internal resolution will be shown.</p> <p>Return to menu by .</p> <p>Select the next menu point „dESC“ with .</p>	<p>„Cnt“</p>
<p>2. Position decimal point /</p> <p>⇒ Press  on display „dESC“; the currently adjusted position of the decimal point will be shown.</p> <p>Select desired setting with  and acknowledge by .</p> <p>⇒ Use  to select the next menu item [CAP].</p>	<p>„dESC“</p> <p>↓</p> <p>„dESC“ „0.00“</p> <p>↓</p> <p>CAP</p>
<p>3. Capacity</p> <p>⇒ Press  on display „CAP“; the currently adjusted capacity will be shown.</p> <p>Select desired setting with  and acknowledge by .</p> <p>Delete with  for changes, and input desired value with the numeric keys.</p> <p>Confirm input with , the balance returns to the menu.</p> <p>⇒ Select the next menu point „div“ with .</p>	<p>„CAP“</p> <p>↓</p> <p>„SEL“ „060.000“</p> <p>↓</p> <p>„CAP“</p>
<p>4. Readability</p> <p>⇒ Press , the current setting will be displayed.</p> <p>Select desired setting by  and confirm with , the balance returns to the menu.</p> <p>⇒ Select the next menu point „AZt“ with .</p>	<p>„div“</p> <p>↓</p> <p>„inC“ „5“</p> <p>↓</p> <p>„div“</p>

<p>5. Automatic zero tracking on display change</p> <p>⇒ Press , the current setting will be displayed.</p> <p>Select desired setting by  and confirm with , the balance returns to the menu.</p> <p>⇒ Select the next menu point „0 AUto“ with  .</p>	<p>„AZt“</p> <p>↓</p> <p>„AZn“ „2d“</p> <p>↓</p> <p>„AZt“</p>
<p>6. Manual zero tracking Range of loads in which the display will be set to zero after actuation of the zero key.</p> <p>⇒ Press , the current setting will be displayed.</p> <p>Select desired setting by  and confirm with , the balance returns to the menu.</p> <p>⇒ Select next menu point „Pin“ with .</p>	<p>„0 mAnL“</p> <p>↓</p> <p>„0 mAnL“ „2“</p> <p>↓</p> <p>„Pin“</p>
<p>7. Password for menu access „tECH“</p> <p>⇒ Press  and input new password with numeric keys.</p> <p>Confirm with  and repeat password input.</p> <p>⇒ Confirm with , the scale will return to its menu. On successful input, „donE“ will be displayed; „FAIL“ will be displayed on faulty input. Repeat input in this case.</p> <p>⇒ Select the next menu point „GrA“ with .</p>	<p>„Pin“</p> <p>↓</p> <p>„Pin1“ „----“</p> <p>↓</p> <p>„Pin2“ „----“</p> <p>„donE“</p>









Adjustment or linearization must be done after configuration.
Implementation of adjustment cf. chapter 14. / Linearization cf. chapter 15.





14 Adjustment







- Provide required adjustment weight, cf. chapter 1.
The adjustment weight to be used depends on the capacity of the weight / counting system. Implement adjustment as close to the maximum load as possible. Info about test weights can be found on the Internet at: <http://www.kern-sohn.com>
- Observe stable environmental conditions. A warming up time (see chapter 1) is required for stabilization.
- In order to avoid errors at the piece quantity determination, both balances must be adjusted with the same acceleration due to gravity.
In case of non-compliance counting errors will result!





14.1 Models CFS 300-3, CFS 3K-5

Operation	Display
⇒ Switch-on balance and during the selftest press  .	„Pin“
⇒ Use the numeric keys to enter password: Either input four times zero „0000“ as a standard password, or input the user-defined password (input cf. parameter „Pin“ chapter 13). ⇒ Confirm input by  .	„Pin“ „----“
⇒ Select bulk material or reference balance via  . The appeared  displays the current balance. When using as counting system, the bulk material balance as well as the reference balance must be adjusted. Both scales must be linearized.	„tECH“ „LoCAL“ ⇕ „tECH“ „rEmotE“
⇒ If necessary, at balance zero display using  select the weighing unit [g / kg or lb], which shall be used for linearization. The appeared  displays the current weighing unit. Acknowledge with  .	„tECH“ „Unit“







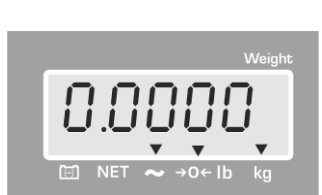





<p>⇒ Ensure that there are no objects on the weighing pan. Wait for stability display (indicator [▼] atop ~ expires), then press .</p>	
<p>⇒ Carefully place required adjustment weight into the center of the weighing plate on display „LoAd“. Wait for stability display, then press .</p>	
<p>⇒ After the adjustment the balance will carry out a self-test. Remove adjusting weight during selftest, balance will return into weighing mode automatically. In case of an adjustment error or incorrect adjusting weight the display will show an error message (<i>FRI L H / FRI L L</i>), repeat adjustment process.</p>	

14.2 Models CFS 6K0.1, CFS 15K0.2, CFS 30K0.5

Operation	Display
<p>⇒ Switch-on balance and during the selftest press .</p>	<p>„Pin“</p>
<p>⇒ Use the numeric keys to enter password: ⇒ Either input four times zero „0000“ as a standard password, or input the user-defined password (input cf. parameter „Pin“ chapter 13). ⇒ Confirm input by .</p>	<p>„Pin“ „----“</p>
<p>⇒ When using as counting system, the bulk material balance as well as the reference balance must be adjusted. The adjustment process must be carried out on both balances. Select bulk material or reference balance via  The appeared [▼] displays the current balance. Acknowledge with .</p>	<p>„tECH“ „LoCAL“ ↕ „tECH“ „rEmotE“</p>
<p>⇒ Using UNIT select the weighing unit [kg or lb] which will be used for linearization. The appeared [▼] displays the current weighing unit. Acknowledge with .</p>	<p>„tECH“ „Unit“</p>

<p>⇒ Ensure that there are no objects on the weighing pan.</p> <p>⇒ Wait for stability display (indicator [▼] atop ~ appears), then press .</p>	
<p>⇒ The currently adjusted adjustment weight (e.g. 6 kg) will be shown. If applicable, change the indicated weight value with the numeric keys.</p> <p>⇒ Acknowledge with .</p>	<p>Display examples model CFS 6K0.1</p>
<p>⇒ Carefully place the indicated weight value for adjustment into the center of the weighing plate on display „LoAd“.</p> <p>⇒ Wait for stability display, then press .</p>	
<p>⇒ After the adjustment the balance will carry out a self-test. Remove adjusting weight during selftest, balance will return into weighing mode automatically. In case of an adjustment error or incorrect adjusting weight the display will show an error message (<i>F A I L H / F A I L L</i>), repeat adjustment process.</p>	

14.3 Model KERN CFS 50K-3

Operation	Display
⇒ Switch-on balance and during the selftest press  .	„Pin“
⇒ Use the numeric keys to enter password: ⇒ Either input four times zero „0000“ as a standard password, or input the user-defined password (input cf. parameter „Pin“ chapter 13). ⇒ Confirm input by  .	„Pin“ „----“
⇒ Select bulk material or reference balance via  . The appeared [▼] displays the current balance. When using as counting system, the bulk material balance as well as the reference balance must be adjusted. The adjustment process must be carried out on both balances. ⇒ Acknowledge with  .	„tECH“ „LoCAL“ ⇕ „tECH“ „rEmotE“
⇒ Using  select the weighing unit [kg or lb] which will be used for linearization. The appeared [▼] displays the current weighing unit. Acknowledge with  .	„tECH“ „Unit“
⇒ Ensure that there are no objects on the weighing pan. ⇒ Wait for stability display (indicator [▼] atop  appears), then press  .	
⇒ Carefully place required adjustment weight (chapter 1) into the center of the weighing plate on display „LoAd“. ⇒ Wait for stability display, then press  .	
⇒ After the adjustment the balance will carry out a self-test. Remove adjusting weight during selftest, balance will return into weighing mode automatically. In case of an adjustment error or incorrect adjusting weight the display will show an error message (FRULH / FRULL), repeat adjustment process.	

15 Linearization

Linearity shows the greatest deviation of a weight display on the scale to the value of the respective test weight according to plus and minus over the entire weighing range.

If linearity deviation is discovered during a monitoring of test resources, you can improve this by means of linearization.

- Carrying out linearization is restricted to specialist staff possessing well acquainted with the workings of weighing scales.
- The adjustment weights to be used must be adapted to the weighing scale's specifications; see chapter 3.4 "testing instruments control".
- Provide for required adjustment weights; cf. subsequent table 1 or table 2.
- Observe stable environmental conditions. Stabilisation requires a certain warm-up time.
- After successful linearisation you will have to carry out calibration; see chapter 3.4 "testing instruments control".

Access to menu:



- ⇒ Switch-on balance and during the selftest press .
- ⇒ Use the numeric keys to input password „9999“ on display „Pin“
- ⇒ Confirm input by .

Table 1: Required adjustment weights KERN CFS

Max	1.	2.	3.	4.
300 g	50 g	100 g	200 g	300 g
3 kg	0.5 kg	1 kg	2 kg	3 kg
6 kg	2 kg	6 kg	-	-
15 kg	5 kg	15 kg	-	-
30 kg	10 kg	30 kg	-	-
50 kg	15 kg	30 kg	50 kg	-

Table 2: Required adjustment weights for interconnected bulk scales

1. Counting systems with reference scales KERN CFS 300-3, CFS 3K-5

















	6 kg	15 kg	30 kg	60 kg	150 kg	300 kg	600 kg	1500 kg	3000 kg
load 1 (1/5 Max)	1 kg	3 kg	6 kg	10 kg	30 kg	60 kg	100 kg	300 kg	600 kg
load 2 (1/3 Max)	2 kg	5 kg	10 kg	20 kg	50 kg	100 kg	200 kg	500 kg	1000 kg
load 3 (2/3 Max)	4 kg	10 kg	20 kg	40 kg	100 kg	200 kg	400 kg	1000 kg	2000 kg
load 4 (max)	6 kg	15 kg	30 kg	60 kg	150 kg	300 kg	600 kg	1500 kg	3000 kg
load 0	0 kg	0 kg	0 kg	0 kg	0 kg	0 kg	0 kg	0 kg	0 kg
load 4 (max)	6 kg	15 kg	30 kg	60 kg	150 kg	300 kg	600 kg	1500 kg	3000 kg
load 3 (2/3 Max)	4 kg	10 kg	20 kg	40 kg	100 kg	200 kg	400 kg	1000 kg	2000 kg
load 2 (1/3 Max)	2 kg	5 kg	10 kg	20 kg	50 kg	100 kg	200 kg	500 kg	1000 kg
load 1 (1/5 Max)	1 kg	3 kg	6 kg	10 kg	30 kg	60 kg	100 kg	300 kg	600 kg















2. Counting systems with reference scale KERN CFS 50-3

	150 kg	300 kg	600 kg	1500 kg	3000 kg
load 1 (1/3 Max)	50kg	100kg	200kg	500kg	1000kg
load 2 (2/3 Max)	100kg	200kg	400kg	1000kg	2000kg
load 3 (max)	150kg	300kg	600kg	1500kg	3000kg

i For counting systems with reference scale CFS 6K0.1, CFS 15K0.5 or CFS 30k0.5, linearization of the bulk scales is impossible.



















15.1 Models CFS 300-3, CFS 3K-5

Operation	Display
⇒ Switch-on balance and during the selftest press  .	„Pin“
⇒ Use the numeric keys to enter password „9999“: Confirm input by  .	„Pin“ „----“
⇒ Select bulk material or reference balance via  . The appeared  displays the current balance. When using as counting system, the bulk material balance as well as the reference balance must be linearized. Both scales must be linearized.	„tECH“ „LoCAL“ ⇕ „tECH“ „rEmotE“
⇒ If necessary, at balance zero display using  select the weighing unit [kg or lb], which shall be used for linearization. The appeared  displays the current weighing unit. Acknowledge with  .	„tECH“ „Unit“
⇒ Ensure that there are no objects on the weighing pan. Wait for stability display (indicator  atop ~ expires), then press  .	
⇒ Carefully place first adjustment weight into the center of the weighing plate on display „LoAd 1“. Wait for stability display, then press  .	
⇒ Carefully place second adjustment weight into the center of the weighing plate on display „LoAd 2“. Wait for stability display, then press  .	
⇒ When „LoAd 3“ is displayed, place the third adjustment weight carefully in the centre of the weighing plate. Wait for stability display, then press  .	

<p>⇒ Carefully place fourth adjustment weight into the center of the weighing plate on display „LoAd 4“.</p> <p>Wait for stability display, then press .</p>	
<p>⇒ Ensure that no objects are on the weighing plate on display „LoAd 0“.</p> <p>Wait for stability display, then press .</p>	
<p>⇒ Carefully place fourth adjustment weight into the center of the weighing plate once more on display „LoAd 4“.</p> <p>Wait for stability display, then press .</p>	
<p>⇒ Carefully place third adjustment weight into the center of the weighing plate once more on display „LoAd 3“.</p> <p>Wait for stability display, then press .</p>	
<p>⇒ Carefully place second adjustment weight into the center of the weighing plate once more on display „LoAd 2“.</p> <p>Wait for stability display, then press .</p>	
<p>⇒ Carefully place first adjustment weight into the center of the weighing plate once more on display „LoAd 1“.</p> <p>Wait for stability display, then press .</p>	
<p>⇒ Ensure that no objects are on the weighing plate on display „LoAd 0“.</p> <p>Wait for stability display, then press .</p>	
<p>⇒ After the adjustment the balance will carry out a self-test. The balance returns automatically into weighing mode. In case of an adjustment error or incorrect adjusting weight the display will show an error message (<i>FRI L H T FRI L L</i>), repeat adjustment process.</p>	

15.2 Model KERN CFS 50K-3

Operation	Display
<p>⇒ Switch-on balance and during the selftest press .</p>	<p>„Pin“</p>

<p>⇒ Use the numeric keys to input password „9999“: Confirm input by .</p>	<p>„Pin“ „----“</p>
<p>⇒ Select bulk material or reference balance via  The appeared  displays the current balance. When using as counting system, the bulk material balance as well as the reference balance must be adjusted. The adjustment process must be carried out on both balances.</p> <p>⇒ Acknowledge with .</p>	<p>„tECH“ „LoCAL“ ⇕ „tECH“ „rEmotE“</p>
<p>⇒ Using  select the weighing unit [kg or lb] which will be used for linearization. The appeared  displays the current weighing unit. Acknowledge with .</p>	<p>„tECH“ „Unit“</p>
<p>⇒ Ensure that there are no objects on the weighing pan. Wait for stability display (indicator  atop  appears), then press .</p>	
<p>⇒ Carefully place first adjustment weight into the center of the weighing plate on display „LoAd 1“. Wait for stability display, then press .</p>	
<p>⇒ Carefully place second adjustment weight into the center of the weighing plate on display „LoAd 2“. Wait for stability display, then press .</p>	
<p>⇒ When „LoAd 3“ is displayed, place the third adjustment weight carefully in the centre of the weighing plate. Wait for stability display, then press .</p>	
<p>⇒ After the adjustment the balance will carry out a self-test. The balance returns automatically into weighing mode. In case of an adjustment error or incorrect adjusting weight the display will show an error message (<i>F A I L H / F A I L L</i>), repeat adjustment process.</p>	

16 Second balance interface

When using as counting system, the platform must be connected with a suitable cable via the second-balance interface.

All models except for CFS 50K-3:



9 pin d-subminiature bushing of the balance		Interconnection of platform KERN KFP
Pin no.:	Balance connection	
Pin 1 or 2	EXC+ (5V)	see labelling of load cell
Pin 4 or 5	EXC- (0)	
Pin 7	SIG-	
Pin 8	SIG+	

Model CFS 50K-3:

Pin no.:	Balance connection	Connection platform
Pin 1	SIG+	see labelling of load cell
Pin 2	SIG-	
Pin 3	not connected	
Pin 4	EXC-	
Pin 5	EXC+	

17 RS 232C interface

The balance is typically equipped with a RS 232C interface. The weighing data can be output depending on the setting in the menu either automatically or by pressing

 or  (in CFS 50K-3) via the interface.

This data exchange is asynchronous using ASCII - Code.

The following conditions must be met to provide successful communication between the weighing balance and the printer.

- Use a suitable cable to connect the weighing balance to the interface of the printer. Faultless operation requires an adequate KERN interface cable.
- Communication parameters (baud rate, bits and parity) of balance and printer must match. Detailed description of the interface parameters see chap. 12.2, Menu block "F2 P r E".

17.1 Technical data

Connection 9 pin d-subminiature bushing

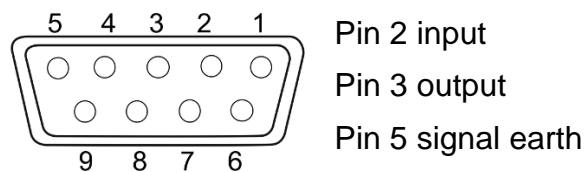

Baud rate 600/1200/2400/4800/**9600**

Parity **8 bits, no parity** / 7 bits, even parity / 7 bits, odd parity

bold printed = factory setting

17.2 Printer operation

17.2.1 Printout example KERN YKB-01N / model CFS 300-3

➤ Counting

S1	Active balance, see chap. 7.3
ID: 123456	User identification number (cf. chapter 12.2)
N 250.001 g	Net weight
1.17647 g/pcs	Average piece weight
212 pcs	Quantity

17.2.2 Printout examples KERN YKB-01N / model CFS 3K-5

➤ Counting

S1	Active balance, see chap. 7.3
ID: 123456	User identification number (cf. chapter 12.2)
N 1.20005 kg	Net weight
2.49991 g/pcs	Average piece weight
480 pcs	Quantity

➤ **Totalization**

1. Weighing

S 1	
ID:	123456
	ABCDEF
N	1.15014 kg
	2.00011 g/Pcs
	575 Pcs
C	

No.	1
C	1.15014 kg
C	575 pcs

Active balance, see chap. 7.3
 User identification number (cf. chapter 12.2)
 Article name (cf. chapter 11)
 Placed net weight
 Average piece weight
 Quantity placed on balance

Number weighing processes
 Total weight
 Total number of pieces

2. Weighing

S 1	
ID:	123456
	ABCDEF
N	0.90001 kg
	2.00011 g/Pcs
	450 Pcs
C	

No.	2
C	2.05015 kg
C	1025 pcs

Active balance, see chap. 7.3
 User identification number (cf. chapter 12.2)
 Article name (cf. chapter 11)
 Placed net weight
 Average piece weight
 Quantity placed on balance

Number weighing processes
 Total weight
 Total number of pieces

Total

S 1	
C	

No.	2
C	2.05015 kg
C	1025 pcs

Active balance, see chap. 7.3

Number weighing processes
 Total weight
 Total number of pieces

17.2.3 Printout examples

KERN YKB-01N / CFS 6K0.1, CFS 15K0.2, CFS 30K0.5

➤ **Summing up /menu adjustment „F2 Prt→Form 1 (cf. chapter12.2)**

1. Weighing

S 1		Active balance, see chap. 7.3
ID:	123456	User identification number (cf. chapter 12.2)
	ABCDEF	Article name (cf. chapter 11)
N	5.0002 kg	Placed net weight
	10 g/Pcs	Average piece weight
	500 Pcs	Quantity placed on balance
C		

No.	1	Number weighing processes
C	5.0002 kg	Total weight
C	500 pcs	Total number of pieces

2. Weighing

S 1		Active balance, see chap. 7.3
ID:	123456	User identification number (cf. chapter 12.2)
	ABCDEF	Article name (cf. chapter 11)
N	2.0002 kg	Placed net weight
	10 g/Pcs	Average piece weight
	200 Pcs	Quantity placed on balance
C		

No.	2	Number weighing processes
C	7.0004 kg	Total weight
C	700 pcs	Total number of pieces

Total

S 1		Active balance, see chap. 7.3
C		

No.	2	Number weighing processes
C	7.0004 kg	Total weight
C	700 pcs	Total number of pieces

➤ **Summing up /menu adjustment „F2 Prt→Form 2 (cf. chapter12.2)**

1. Weighing

S 1	
ID:	123456
	ABCDEF
N	2.5003 kg
G	3.0000 kg
T	0.4997 kg
	10 g/Pcs
	250 Pcs
C	

No.	1
C	2.5003 kg
C	250 pcs

Active balance, see chap. 7.3
 User identification number (cf. chapter 12.2)
 Article name (cf. chapter 11)
 Placed net weight
 Gross weight put on
 Tare weight
 Average piece weight
 Quantity placed on balance

Number weighing processes
 Total weight
 Total number of pieces

2. Weighing

S 1	
ID:	123456
	ABCDEF
N	5.5003 kg
G	6.0000 kg
T	0.4997 kg
	10 g/Pcs
	550 Pcs
C	

No.	2
C	8.0006 kg
C	800 pcs

Active balance, see chap. 7.3
 User identification number (cf. chapter 12.2)
 Article name (cf. chapter 11)
 Placed net weight
 Gross weight put on
 Tare weight
 Average piece weight
 Quantity placed on balance

Number weighing processes
 Total weight
 Total number of pieces

Total

S 1	
C	

No.	2
C	8.0006 kg
C	800 pcs

Active balance, see chap. 7.3
 Number weighing processes
 Total weight
 Total number of pieces

➤ **Summing up /menu adjustment „F2 Prt→Form 3 (cf. chapter12.2)**

1. Weighing

S 1	
ID:	123456
	ABCDEF
N	2.5002 kg
G	2.9999 kg
T	0.4997 kg
	10 g/Pcs
	250 Pcs
HI	100 PCS
LO	90 PCS
	-----HI-----
C	

No.	1
C	2.5002 kg
C	250 pcs

Active balance, see chap. 7.3
 User identification number (cf. chapter 12.2)
 Article name (cf. chapter 11)
 Placed net weight
 Gross weight put on
 Tare weight
 Average piece weight
 Quantity placed on balance
 Upper tolerance limit, see chap. 9.2
 Lower tolerance limit, see chap. 9.2
 Target number of pieces exceeding the given tolerance

 Number weighing processes
 Total weight
 Total number of pieces

2. Weighing

S 1	
ID:	123456
	ABCDEF
N	0.5002 kg
G	0.9999 kg
T	0.4997 kg
	10 g/Pcs
	50 Pcs
HI	100 PCS
LO	90 PCS
	-----LO-----
C	

No.	2
C	3.0004 kg
C	300 pcs

Active balance, see chap. 7.3
 User identification number (cf. chapter 12.2)
 Article name (cf. chapter 11)
 Placed net weight
 Gross weight put on
 Tare weight
 Average piece weight
 Quantity placed on balance
 Upper tolerance limit, see chap. 9.2
 Lower tolerance limit, see chap. 9.2
 Target number of pieces below the given tolerance

 Number weighing processes
 Total weight
 Total number of pieces

3. Weighing

S 1	
ID:	123456
	ABCDEF
N	1.0002 kg
G	1.4999 kg
T	0.4997 kg
	10 g/Pcs
	100 Pcs
HI	100 PCS
LO	90 PCS
	-----OK-----
C	

No.	3
C	4.0006 kg
C	400 pcs

Active balance, see chap. 7.3
 User identification number (cf. chapter 12.2)
 Article name (cf. chapter 11)
 Placed net weight
 Gross weight put on
 Tare weight
 Average piece weight
 Quantity placed on balance
 Upper tolerance limit, see chap. 9.2
 Lower tolerance limit, see chap. 9.2
 Target number of pieces within the given tolerance

Total

S 1	
C	

No.	3
C	4.0006 kg
C	400 pcs

Active balance, see chap. 7.3

 Number weighing processes
 Total weight
 Total number of pieces

17.2.4 Printout examples KERN YKB-01N / model CFS 50K-3

➤ Totalization

1. Weighing

LOCAL SCALE	Active balance, see chap. 7.3
ID: 123456	User identification number (cf. chapter 12.2)
ABCDEF GHIJKL	Article name (cf. chapter 11)
6.500 kg NET	Placed net weight
100 g U. W.	Average piece weight
65 PCS	Quantity placed on balance
TOTAL	

6.500 kg NET	Total weight
65 TPC	Total number of pieces
1 NO	Number weighing processes

2. Weighing

LOCAL SCALE	Active balance, see chap. 7.3
ID: 123456	User identification number (cf. chapter 12.2)
ABCDEF GHIJKL	Article name (cf. chapter 11)
14.502 kg NET	Placed net weight
100 g U. W.	Average piece weight
145 PCS	Quantity placed on balance
TOTAL	

21.002 kg NET	Total weight
210 TPC	Total number of pieces
2 NO	Number weighing processes

Total

LOCAL SCALE	Active balance, see chap. 7.3
TOTAL	

21.002 kg NET	Total weight
210 TPC	Total number of pieces
2 NO	Number weighing processes

17.3 Remote control instructions

17.3.1 All models except for KERN CFS 50-3

All inputs finish with <CR><LF> (carriage return / line feed).

At wrong inputs the command will be preceded by "ER", e.g. order "NN<CR><LF>", error message "ER NN<CR><LF>".

17.3.2 Control commands

PLU _{xx}	Call article from data storage
T	Tare placed weighing vessel
T123.456	Use the numeric keys to input tare value e.g. 123.456
Z	Zeroing
P	Printing
M+	Add and print weighing data in the summation memory
MR	Call data from sum storage
MC	Delete total added memory
U123.456	Use the numeric keys to input the average article weight 123.456 [g] or [lb].
S123	Define average article weight via weighing. Function identical to  key.
SL	Switch over to reference balance
SR	Switch over to bulk scales

17.3.3 Printing commands

\L	Selection reference or bulk material balance
\I	User identification number
\S	Balance identification number
\N	Net weight
\G	Gross weight
\U	Average piece weight
T	Tare value
\P	Counting
\C	Total number of pieces
\W	Total weight
\M	Number of summing processes
\B	Insert space line

17.3.4 Model CFS 50-3

Do **not** finish inputs with <CR><LF> (carriage return / line feed).

T	Taring
Z	Zeroing
P	Printing

17.3.5 User identification, scale identification, store article name

SUID	xxxxxx	<CR>
	User identification number no more than 6 characters	
SSID	xxxxxx	<CR>
	Scale identification number no more than 6 characters	
SSID	xx,	xxxxxxxxxxxxx <CR>
Storage place 2 characters + comma	Article name No more than 12 characters	



Unavailable in model CFS 50-3

17.3.6 Register / call article via RS232

Register article:

	Function	Command
1.	Input tare value e.g. 500 g Where no tare value is needed, input zero	T0.500<CR> T0<CR>
2.	Average piece weight e.g. enter 12.3456 g/ piece	U12.3456<CR>
3.	Storage place e.g. 1 (PLU01) followed by the article name, e.g. M4 screws	SPLU01,M4screws<CR>

Call article:

Command „PLUxx <CR>,,, e.g. „PLU01“:

The stored tare value, e.g. 500 g, the average piece weight, e.g. 12.3456 g and the article name, e.g. „M4 screws“, will be called and displayed.



Unavailable in model CFS 50-3

17.4 I/O-function

RS-232

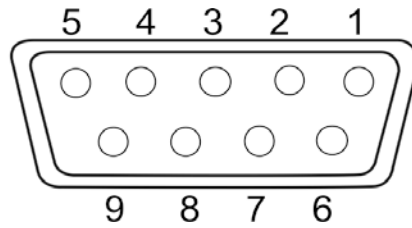
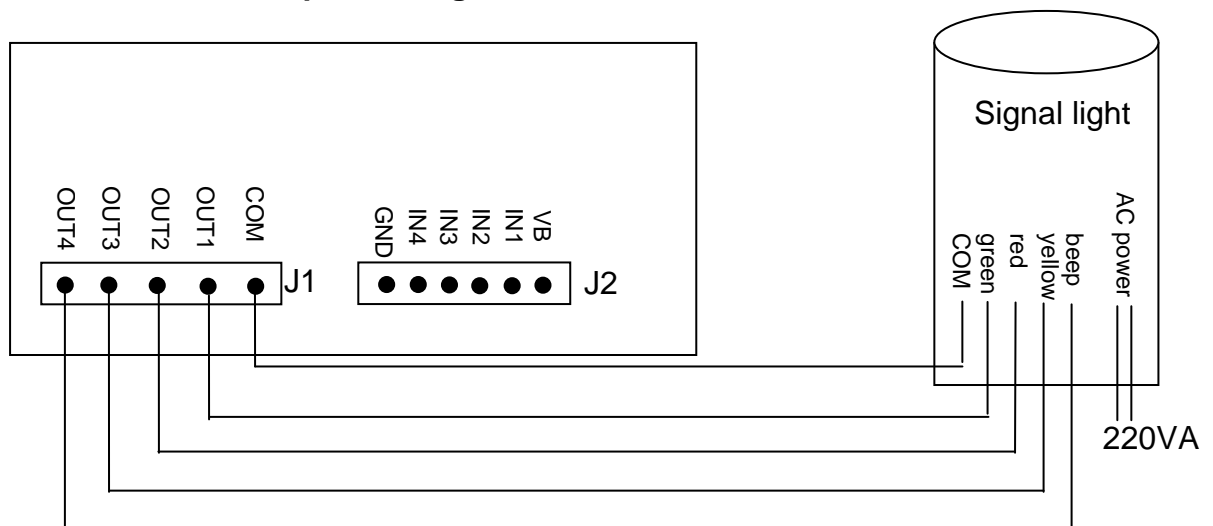

Fig.: 9 pin d-subminiature bushing

RS232	Pin 2	RXD	
	Pin 3	TXD	
	Pin 4	VCC	5V
	Pin 5	GND	
Shift point	Pin 1	VB	
	Pin 5	GND	
	Pin 6	OK	
	Pin 7	LOW	
	Pin 8	HI	
	Pin 9	BEEP	

Connection example with lights CFS-A02



U_{OH}	High-Level Output Voltage	2.4 V	
U_{OL}	Low-Level Output Voltage		0.4 V

18 Servicing, maintenance, disposal



Before any maintenance, cleaning and repair work disconnect the appliance from the operating voltage.

18.1 Cleaning

Please do not use aggressive cleaning agents (solvents or similar agents), but a cloth dampened with mild soap suds. Ensure that no liquid penetrates into the device. Polish with a dry soft cloth.

Loose residue sample/powder can be removed carefully with a brush or manual vacuum cleaner.

Spilled weighing goods must be removed immediately.

18.2 Servicing, maintenance

⇒ The appliance may only be opened by trained service technicians who are authorized by KERN.

⇒ Before opening, disconnect from power supply.

18.3 Disposal

Disposal of packaging and appliance must be carried out by operator according to valid national or regional law of the location where the appliance is used.

19 Instant help

In case of an error in the program process, briefly turn off the balance and disconnect from power supply. The weighing process must then be restarted from the beginning.

Fault	Possible cause
The displayed weight does not glow.	<ul style="list-style-type: none">• The balance is not switched on.• The mains supply connection has been interrupted (mains cable not plugged in/faulty).• Power supply interrupted.
The displayed weight is permanently changing	<ul style="list-style-type: none">• Draught/air movement• Table/floor vibrations• Weighing pan has contact with other objects.• Electromagnetic fields / static charging (choose different location/switch off interfering device if possible)
The weighing result is obviously incorrect	<ul style="list-style-type: none">• The display of the balance is not at zero• Adjustment is no longer correct.• The balance is on an uneven surface.• Great fluctuations in temperature.• Warm-up time was ignored.• Electromagnetic fields / static charging (choose different location/switch off interfering device if possible)

19.1 Error messages

Error message	Description	Possible reasons/ solution
Err 4	Zeroing range exceeded due to switching-on balance or pressing  (normally 4% max)	<ul style="list-style-type: none"> • Object on the weighing plate • Overload when zeroing • Inappropriate adjustment • Damaged weighing cell • Damaged electronics
Err 5	Keyboard error	<ul style="list-style-type: none"> • Unpurposeful operation of the scale
Err 6	Value outside the A/D changer range	<ul style="list-style-type: none"> • Weighing plate not installed • Damaged weighing cell • Damaged electronics
Err 19	Zero point displaced	<ul style="list-style-type: none"> • Remedy: Adjust / linearize
FAIL H / FAIL L	Adjustment error	<ul style="list-style-type: none"> • Inappropriate adjustment

Should other error messages occur, switch balance off and then on again. If the error message remains inform manufacturer.

20 Declaration of conformity



KERN & Sohn GmbH

D-72322 Balingen-Frommern

Postbox 4052

E-Mail: info@kern-sohn.de

Phone: 0049-[0]7433- 9933-0

Fax: 0049-[0]7433-9933-149

Internet: www.kern-sohn.de

Declaration of conformity

EC-Konformitätserklärung
EC- Déclaration de conformité
EC-Dichiarazione di conformità
EC- Declaração de conformidade
EC-Deklaracja zgodności

EC-Declaration of -Conformity
EC-Declaración de Conformidad
EC-Conformiteitverklaring
EC- Prohlášení o shode
EC-Заявление о соответствии

D	Konformitäts- erklärung	Wir erklären hiermit, dass das Produkt, auf das sich diese Erklärung bezieht, mit den nachstehenden Normen übereinstimmt.
EN	Declaration of conformity	We hereby declare that the product to which this declaration refers conforms to the following standards.
CZ	Prohlášení o shode	Tímto prohlašujeme, že výrobek, kterého se toto prohlášení týká, je v souladu s níže uvedenými normami.
E	Declaración de conformidad	Manifestamos en la presente que el producto al que se refiere esta declaración está de acuerdo con las normas siguientes
F	Déclaration de conformité	Nous déclarons avec cela responsabilité que le produit, auquel se rapporte la présente déclaration, est conforme aux normes citées ci-après.
I	Dichiarazione di conformità	Dichiariamo con ciò che il prodotto al quale la presente dichiarazione si riferisce è conforme alle norme di seguito citate.
NL	Conformiteit- verklaring	Wij verklaren hiermede dat het product, waarop deze verklaring betrekking heeft, met de hierna vermelde normen overeenstemt.
P	Declaração de conformidade	Declaramos por meio da presente que o produto no qual se refere esta declaração, corresponde às normas seguintes.
PL	Deklaracja zgodności	Niniejszym oświadczamy, że produkt, którego niniejsze oświadczenie dotyczy, jest zgodny z poniższymi normami.
RUS	Заявление о соответствии	Мы заявляем, что продукт, к которому относится данная декларация, соответствует перечисленным ниже нормам.

Electronic Balance: KERN CFS

EU Directive	Standards
2004/108/EC	EN55022: 2006 A1:2007 EN61000-3-3:1995+A1:2001+A2:2005 EN55024: 1998+A1:2001+A2:2003
2006/95/EC	EN 60950-1:2006 EN 60065:2002+A1:2006

Date 24.02.2014
Date

Ort der Ausstellung 72336 Balingen
Place of issue

Signatur
Signature

Albert Sauter
KERN & Sohn GmbH
Manager
Managing director

KERN & Sohn GmbH, Ziegelei 1, D-72336 Balingen, Tel. +49-[0]7433/9933-0
Fax +49-[0]7433/9933-149, E-Mail: info@kern-sohn.com, Internet: www.kern-sohn.com