

FLUKE®

233

True-rms Remote Display Digital Multimeter

Users Manual

September 2009

© 2009 Fluke Corporation. All rights reserved. Specifications are subject to change without notice.
All product names are trademarks of their respective companies.

LIMITED WARRANTY AND LIMITATION OF LIABILITY

This Fluke product will be free from defects in material and workmanship for three years from the date of purchase. This warranty does not cover fuses, disposable batteries, or damage from accident, neglect, misuse, alteration, contamination, or abnormal conditions of operation or handling. Resellers are not authorized to extend any other warranty on Fluke's behalf. To obtain service during the warranty period, contact your nearest Fluke authorized service center to obtain return authorization information, then send the product to that Service Center with a description of the problem.

THIS WARRANTY IS YOUR ONLY REMEDY. NO OTHER WARRANTIES, SUCH AS FITNESS FOR A PARTICULAR PURPOSE, ARE EXPRESSED OR IMPLIED. FLUKE IS NOT LIABLE FOR ANY SPECIAL, INDIRECT, INCIDENTAL OR CONSEQUENTIAL DAMAGES OR LOSSES, ARISING FROM ANY CAUSE OR THEORY. Since some states or countries do not allow the exclusion or limitation of an implied warranty or of incidental or consequential damages, this limitation of liability may not apply to you.

Fluke Corporation
P.O. Box 9090
Everett, WA 98206-9090
U.S.A.

Fluke Europe B.V.
P.O. Box 1186
5602 BD Eindhoven
The Netherlands

Table of Contents

Title	Page
Introduction	1
How to Contact Fluke	1
Safety Information	2
Warnings and Cautions	2
Radio Frequency Data.....	5
Hazardous Voltage.....	6
Test Lead Alert.....	6
Features	8
Error Messages.....	12
Battery Saver™(Sleep Mode)	13
MIN MAX AVG Record Mode.....	13
Display Hold.....	14
Manual and Autoranging	14
Backlight.....	15
Power-Up Options	15

How to Make Measurements	16
AC and DC Voltage Measurements	16
Resistance Measurements	17
Temperature Measurements	19
Continuity Tests	19
Diode Tests	21
Capacitance Measurements	23
AC and DC Current Measurements	24
Frequency Measurements	26
Remote Operation	26
Remove the Display Module	27
Dock the Display Module with the Meter base	28
Maintenance	29
General Maintenance	29
Battery Replacement	29
Fuse Test	33
Fuse Replacement	34
Service and Parts	35
General Specifications	38
Detailed Specifications	39
AC Voltage	39
DC Voltage, Conductance, and Resistance	40
Continuity	40
Temperature	40
AC Current	41
DC Current	41
Capacitance	42
Diode	42

Frequency	43
Input Characteristics	43
MIN MAX Recording	44

List of Tables

Table	Title	Page
1.	Electrical Symbols	7
2.	Display	8
3.	Inputs	10
4.	Function Switch Positions.....	11
5.	Error Messages	12
6.	Power-Up Options	15
7.	Replacement Parts	35
8.	Accessories	37

List of Figures

Figure	Title	Page
1.	AC and DC Voltage Measurements	16
2.	Resistance Measurements	18
3.	Continuity Tests	20
4.	Diode Test	22
5.	Capacitance Measurements	23
6.	Current Measurements	25
7.	Display Module Separation	27
8.	Dock Display Module with Meter Base	28
9.	Meter Base Battery Replacement	30
10.	Display-Module Battery Removal	32
11.	Fuse Test	33
12.	Fuse Replacement	34
13.	Replacement Parts	36

Introduction

The Fluke 233 (hereafter the Meter) is a compact and easy to operate tool for electrical and electronic circuit measurements.

⚠ ⚠ Warning

Read "Safety Information" before you use the Meter.

How to Contact Fluke

Use one of the telephone numbers below to speak with a Fluke representative:

Technical Support USA: 1-800-44-FLUKE (1-800-443-5853)

Calibration/Repair USA: 1-888-99-FLUKE (1-888-993-5853)

Canada: 1-800-36-FLUKE (1-800-363-5853)

Europe: +31 402-675-200

Japan: +81-3-3434-0181

Singapore: +65-738-5655

Anywhere in the world: +1-425-446-5500

Or, visit Fluke's website at www.fluke.com.

To register your product, visit <http://register.fluke.com>.

To see, print, or download the latest manual supplement, visit <http://us.fluke.com/usen/support/manuals>.

Safety Information

The Meter complies with:

- ISA-82.02.01
- CAN/CSA C22.2 No. 61010-1-04
- ANSI/UL 61010-1:2004
- EN 61010-1:2001
- EN 61326-1:2006
- EN 61326-2-2:2006
- ETSI EN 300 328 V1.7.1:2006
- ETSI EN 300 489 V1.8.1:2008
- FCC Part 15 Subpart C Sections 15.207, 15.209, 15.249 FCCID: T68-F233
- RSS-210 IC: 6627A-F233
- Measurement Category III, 1000V, Pollution Degree 2
- Measurement Category IV, 600V, Pollution Degree 2

In this manual, a **Warning** identifies the conditions and procedures that cause a dangerous situation to the user. A **Caution** identifies the conditions and procedures that could cause damage to the Meter, equipment under test damage, or permanent data loss.

The symbols used on the Meter and in this manual are shown in Table 1.

Warnings and Cautions

Warning

To prevent possible electrical shock or personal injury, follow these guidelines:

- Use this Meter only as specified in this manual or the protection can be compromised.
- Do not use the Meter if it is damaged. Before you use the Meter, examine the case. Look for cracks or missing plastic. Carefully look at the insulation around the terminals.
- Make sure the battery door is closed and locked before you operate the Meter.
- Replace the batteries when the battery indicator () appears.

- Remove the test leads from the Meter before the battery door on the Meter base is opened.
- Examine the test leads for damaged insulation or exposed metal. Measure the test leads for continuity. Replace damaged test leads before you use the Meter.
- Do not apply more than the rated voltage, shown on the Meter, between the terminals or between a terminal and earth ground.
- Do not operate the Meter with the battery door removed or the case open.
- Be careful around voltages >30 V ac rms, 42 V ac peak, or 60 V dc. These voltages pose a shock hazard.
- Use only the replacement fuse specified by the manual.
- Use the correct terminals, function, and range for measurements.
- Do not work alone.
- For current measurements, connect the Meter to the circuit after you remove circuit power. Always put the Meter in series with the circuit.
- Connect the common test lead before the live test lead and remove the live test lead before the common test lead.
- Do not use the Meter if it operates incorrectly. Protection can be compromised. If you are unsure, have the Meter examined.
- Do not use the Meter around explosive gas, vapor or in damp or wet environments.

- Use only specified 1.5-V AA batteries (three in the Meter base and two in the display), correctly installed, for Meter power.
- Comply with local and national safety requirements when in hazardous locations.
- Only use test leads that have the same voltage, category, and amperage ratings as the Meter and that are approved by a safety Agency.
- Measure a known voltage first to make sure that the Meter operates correctly. If you are unsure, have the Meter examined.
- Use protective equipment, as directed by local or national authorities when in hazardous work areas.
- Measure the test leads for continuity before use. Do not use if the resistance is high or noisy.
- Use only specified replacement parts in the Meter.
- Keep fingers behind the finger guards on the probes.

Caution

To prevent damage to the Meter or to the equipment under test, follow these guidelines:

- Disconnect circuit power and discharge all high-voltage capacitors before you do diode tests or measure resistance, continuity, or capacitance.
- Use the correct terminals, function, and range for all measurements.
- Before a current measurement, do the fuse test.

Radio Frequency Data

Note

Changes or modifications to the wireless 2.4 GHz radio not expressly approved by Fluke Corporation could void the user's authority to operate the equipment.

This device complies with Part 15 of the FCC Rules. Operation is subject to the two conditions that follow: (1) this device can not cause interference, and (2) this device must accept any interference, including interference that can cause undesired operation of the device.

Class B digital device: A digital device that is marketed for operation in a residential environment notwithstanding use in commercial, business and industrial environments. Examples of such devices include, but are not limited to, personal computers, calculators, and equivalent electronic devices that are marketed for operation by the general public.

The Meter was tested and found to comply with the limits for a Class B digital device, pursuant to Part 15 of the FCC Rules. These limits are designed to provide reasonable protection against harmful interference in a residential installation. This equipment generates, uses, and can radiate radio frequency energy and, if not installed and used in accordance with the instructions, can cause harmful interference to radio communications. However, there is no guarantee that interference will not

occur in a particular installation. If this equipment does cause harmful interference to radio or television reception, which can be determined by turning the equipment off and on, the user is encouraged to try to correct the interference by one or more of the measures that follow:

- Reorient or relocate the receiving antenna.
- Increase the separation between the equipment and receiver.
- Consult the dealer or an experienced radio/TV technician for help.

The term "IC:" before the radio certification number only signifies the device meets Industry's Canada technical specifications.

Hazardous Voltage

When the Meter senses a voltage ≥ 30 V or a voltage overload (OL), the f symbol is shown on the display and the red high-voltage LED on the Meter base illuminates to tell you a hazardous voltage is at the Meter input. For frequency measurements > 1 kHz, the f symbol and high-voltage LED is unspecified.

















Test Lead Alert

Warning

To prevent personal injury or damage to the Meter do not make a measurement with a test lead in an incorrect terminal.

To make sure that you have the test leads in the correct terminals, the LED briefly shows in the display and a beep sounds when you move the function switch to or from an A (Amps) position.

Table 1. Electrical Symbols

	AC (Alternating Current)		Earth ground
	DC (Direct Current)		Fuse
	Hazardous voltage		Conforms to European Union directives.
	Risk of Danger. Important information. See Manual.		Conforms to relevant Canadian Standards Association directives.
	Battery. Low battery when shown.		Double insulated
	Continuity test or continuity beeper tone.		Capacitance
CAT III	IEC Measurement Category III CAT III equipment has protection against transients in equipment in fixed-equipment installations, such as distribution panels, feeders and short branch circuits, and lighting systems in large buildings.	CAT IV	IEC Measurement Category IV CAT IV equipment has protection against transients from the primary supply level, such as an electricity meter or an overhead or underground utility service.
	Do not discard this product as unsorted municipal waste. Go to the Fluke website for recycling data.		Diode
	Examined and licensed by TÜV Product Services.		Conforms to relevant Australian standards.

Features

See Tables 3 through 4 for a list of Meter features with a short feature description.

Table 2. Display

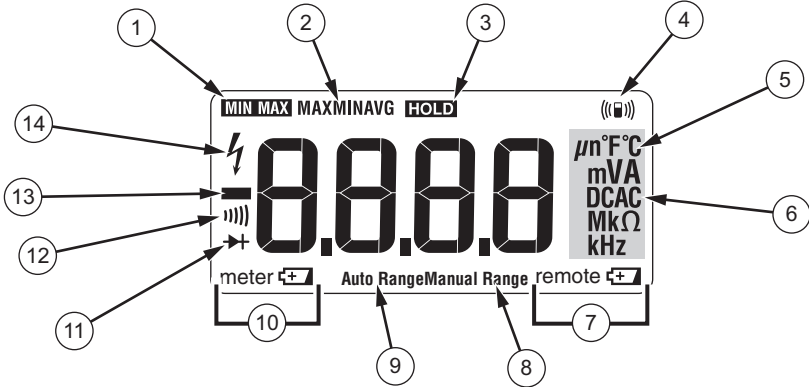

gcc101.eps

No.	Symbol	Indication
1	MIN MAX	MIN MAX AVG mode on.
2	MAX MIN AVG	Maximum, minimum, or average measurement shown.
3	HOLD	Display hold on. Display freezes the measurement.

Table 2. Display (cont.)





No.	Symbol	Indication
4	(())	Radio connection indicator.
5	°C, °F	degrees Celsius, degrees Fahrenheit
6	A	amperes (amps)
	V, mV	volts, millivolts
	μF, nF	microfarad, nanofarad
	DC AC	Direct current or alternating current.
	Ω, MΩ, kΩ	ohm, megohm, kilohm
	Hz, kHz	hertz, kilohertz
7	remote 	Battery low warning for the display module.
8	Manual Range	Manual range set.
9	Auto Range	Auto range set.
10	meter 	Battery low warning for Meter base.
11		Diode test mode.
12)))	Continuity test.
13	-	Input is a negative value.
14		 Hazardous voltage. Measured input voltage ≥ 30 V, or voltage overload condition (OL)

Table 3. Inputs



gcc110.eps

No.	Terminal	Description
1	A	Input for 0 A to 10.00 A current measurements.
2	COM	Common terminal for all measurements.
3	 VΩ	Input for voltage, continuity, resistance, diode, capacitance, temperature, and frequency measurements.

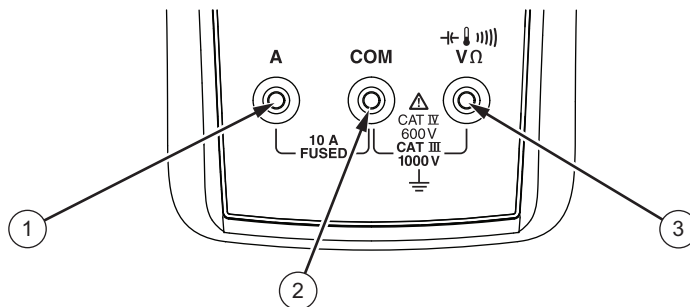
Table 4. Function Switch Positions

Switch Position	Description
\tilde{V}_{Hz} Hz (button)	AC voltage from 0.06 to 1000 V. Frequency from 5 Hz to 50 kHz.
\overline{V}	DC voltage from 0.001 V to 1000 V.
\overline{mV}	AC voltage from 6.0 to 600.0 mV, dc-coupled. DC voltage from 0.1 to 600.0 mV.
Ω	Ohms from 0.1 Ω to 40 M Ω . Continuity beeper turns on at <20 Ω and turns off at >250 Ω .
$\overleftarrow{F} \rightarrow$	Farads from 1 nF to 9999 μ F. Diode Test. OL shows in the display when the input voltage is >2.0 V.
\updownarrow	Temperature.
\tilde{A}_{Hz} Hz (button)	AC current from 0.1 A to 10 A (>10 to 20 A, 30 seconds on, 10 minutes off). >10.00 A display flashes. >20 A, OL is shown. DC-coupled. Frequency from 45 Hz to 5 kHz.
\overline{A}	DC current from 0.001 A to 10 A (>10 to 20 A, 30 seconds on, 10 minutes off). >10.00 A display flashes. >20 A, OL is shown.
Note: All ac functions are true-rms. AC voltage is ac-coupled. AC mV and ac amps are dc-coupled.	

Error Messages

Table 5 contains possible error messages and the steps to clear the error.

Table 5. Error Messages

Error Messages	
bAtt d ISP	Display-module batteries must be replaced before the Meter will operate.
bAtt bASE	Meter-base batteries must be replaced before the Meter will operate.
CAL Err	Calibration necessary. Meter calibration is necessary before the Meter will operate.
EEPROM Err	Internal error. The Meter must be repaired before it will operate.
rF Err	Loss of radio connection with the Meter base.

Battery Saver™ (Sleep Mode)

The Meter powers-down (Sleep mode) if there is no function change, range change, or button push for 20 minutes. The lowest power drain occurs when the display module is docked with the Meter base. With the display module removed from the Meter base, the power drain is more because the radios are turned on.

To wake up the Meter, push a button or turn the function switch.

To disable the Sleep mode, hold down the button while turning the Meter on. The Sleep mode is always disabled in the MIN MAX AVG mode.

MIN MAX AVG Record Mode

The MIN MAX AVG record mode records the minimum and maximum input values, and calculates an average of all measurements. Each new high or low measurement causes the Meter to beep.

- Set the Meter to the measurement function and range.
- Push to enter MIN MAX AVG mode.
- **MIN MAX** and MAX are shown and the highest measurement detected since **MIN MAX** is shown.
- Push to step through the low (MIN), average (AVG), and present measurements.

- To pause MIN MAX AVG record mode, push . **HOLD** is shown. A pause does not erase recorded MIN MAX AVG measurements.
- To continue the MIN MAX AVG record mode, push again.
- To exit and erase recorded measurements, push for at least one second or turn the function switch.

Display Hold

Warning

To prevent electrical shock, when Display HOLD is on, disable Display HOLD to measure the voltage that is possibly different than the Display HOLD measurement.

Display HOLD freezes the display.

1. Push **HOLD** to activate Display HOLD. (**HOLD** is shown.)
2. To exit and start normal operation, push **HOLD** or turn the function switch.

Manual and Autoranging

The Meter has Manual and Autorange modes.

- In the Autorange mode, the Meter sets the range to one with the best resolution for the input signal.
- In the Manual Range mode, you override Autorange and set the range yourself.

When you turn the Meter on, it is set to Autorange and **Auto Range** shows in the display.

1. To set the Meter to the Manual Range mode, push **RANGE**. **Manual Range** shows in the display.

2. In the Manual Range mode, push **RANGE** to increment the range. After the highest range, the range of the Meter is set to the lowest range.



Note

You cannot manually change the range in the MIN MAX AVG or Display HOLD modes.

*If you push **RANGE** while in MIN MAX AVG or Display HOLD, the Meter beeps twice, indicating an invalid operation and the range does not change.*

3. To exit Manual Range, push **RANGE** for at least one second or turn the function switch. The Meter is set to Autorange and **Auto Range** shows in the display.





Backlight

Push  to toggle the backlight on and off. The backlight automatically extinguishes after 40 seconds. To disable backlight auto-off, hold down  while turning the Meter on.

Power-Up Options

Hold a button down while the function switch is moved from the OFF position to set a power-up option. The power-up options cancel when the function switch is moved to OFF or the Meter goes into Sleep mode. See Table 6 for all power-up options.

Table 6. Power-Up Options

Button	Power-Up Options
	Illuminates all display segments.
	Disables the beeper. bEEP is shown when on.
	Disables automatic power-down ("Sleep mode"). P _{OFF} is shown when on.
	Disables backlight auto-off. L _{OFF} is shown when on.

How to Make Measurements

The sections that follow tell how to make measurements with the Meter.

To connect the test leads to the circuit or device, connect the common (**COM**) test lead first. To remove the test leads, remove the common test lead last.

AC and DC Voltage Measurements

The voltage ranges are 600.0 mV, 6.000 V, 60.00 V, 600.0 V, and 1000 V. To set the 600.0 mV dc or ac range, turn the function switch to mV . Millivolts ac is set first. Push \square to switch to millivolts dc.

Refer to Figure 1 to measure ac or dc voltage.

For voltage measurements, the Meter puts approximately 10 M Ω (10,000,000 Ω) in parallel with the circuit. This load can cause measurement errors in high-impedance circuits. In most cases, the error is negligible (0.1 % or less) if the circuit impedance is 10 k Ω (10,000 Ω) or less.

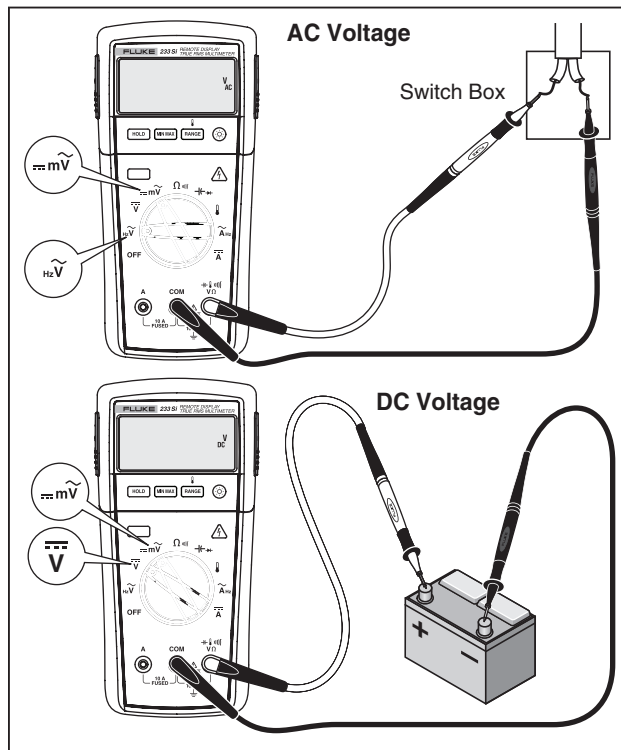

gcc102.eps

Figure 1. AC and DC Voltage Measurements

Resistance Measurements

⚠ Caution

To prevent possible damage to the Meter or to the equipment under test, disconnect power and discharge all high-voltage capacitors before resistance measurements.

The Meter sends a small current through the circuit for resistance measurements. Because this current flows through all possible paths between the probes, the resistance measured is the total resistance of all paths between the probes.

The resistance ranges are 600.0 Ω , 6.000 k Ω , 60.00 k Ω , 600.0 k Ω , 6.000 M Ω , and 40.00 M Ω .

Set the Meter as shown in Figure 2 to measure resistance.

Below are some hints for resistance measurements:

- The measured value of a resistor in a circuit is frequently different from the specified resistor value.
- The test leads can add 0.1 Ω to 0.2 Ω of error to resistance measurements. To measure test lead resistance, touch the probe points together and read the resistance.
- The resistance function uses sufficient voltage to forward-bias silicon diode or transistor junctions, and cause current to flow. If you think current flows through the junction, push **RANGE** to apply a lower

current in the next higher range. If the value is higher, use the higher value. Refer to the Input Parameters table in the specifications section for typical short-circuit currents.

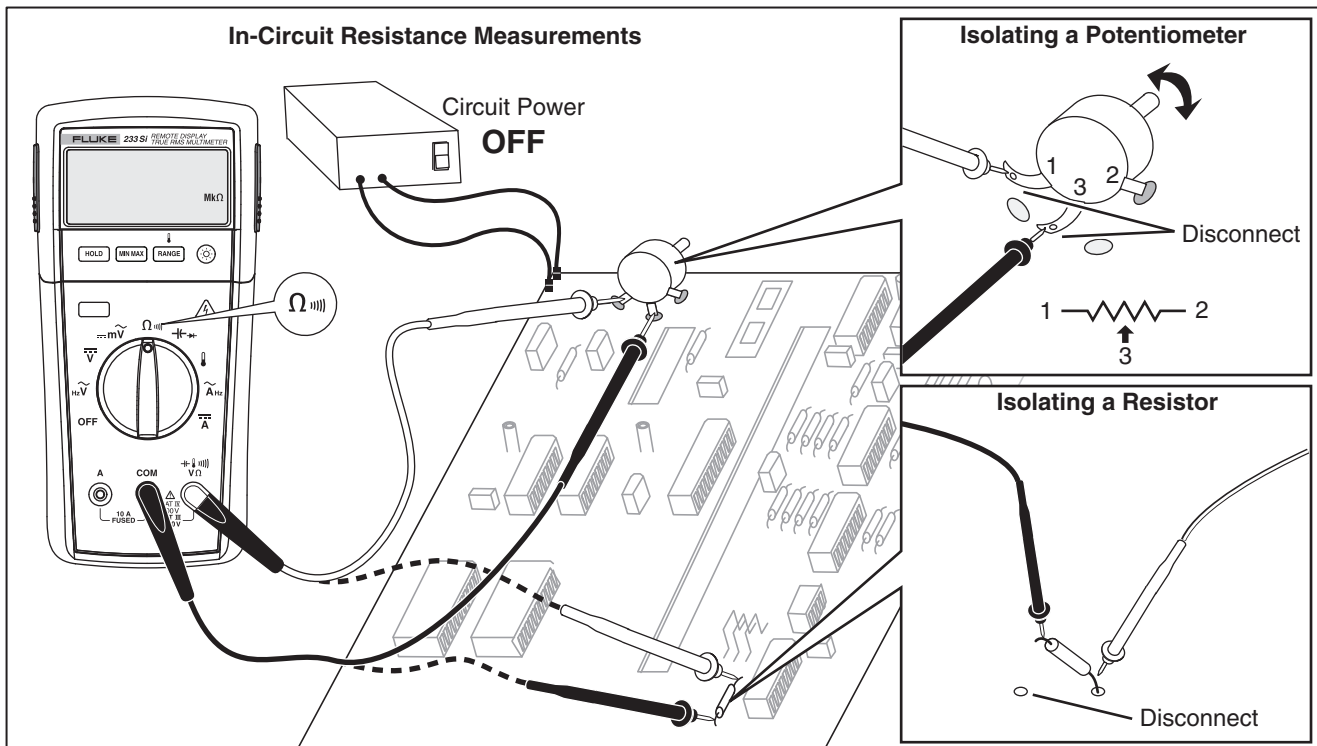

Figure 2. Resistance Measurements

gcc106.eps

Temperature Measurements

The Meter measures the temperature of a type-K thermocouple (included). Choose between degrees Celsius (°C) or degrees Fahrenheit (°F) by pushing

RANGE.

⚠ Caution

To prevent possible damage to the Meter or other equipment, use a thermocouple rated for the temperatures to be measured. The Meter is rated for -40.0 °C to +400.0 °C and -40.0 °F to 752 °F, but the included type-K thermocouple is rated to 260 °C.

The temperature ranges are -40.0 °C to +400 °C and -40.0 °F to 752 °F. All other temperatures show $\square\square$ on the display. When there is no thermocouple connected, the display shows $\square\square\square\square$.

To measure temperature:

1. Connect a type-K thermocouple to the COM and $\frac{+}{-} \frac{\square}{\square}$ terminals of the Meter.
2. Turn the function switch to \downarrow .
3. Push **RANGE** to choose Celsius or Fahrenheit.

Continuity Tests

⚠ Caution

To prevent possible damage to the Meter or the equipment under test, disconnect power and discharge all high-voltage capacitors before a continuity test.

The continuity test uses a beeper that sounds when a closed circuit is sensed. The beeper lets you do continuity tests without the necessity to look at the display.

To do a continuity test, set up the Meter as shown in Figure 3.

For in-circuit tests, turn circuit power off.

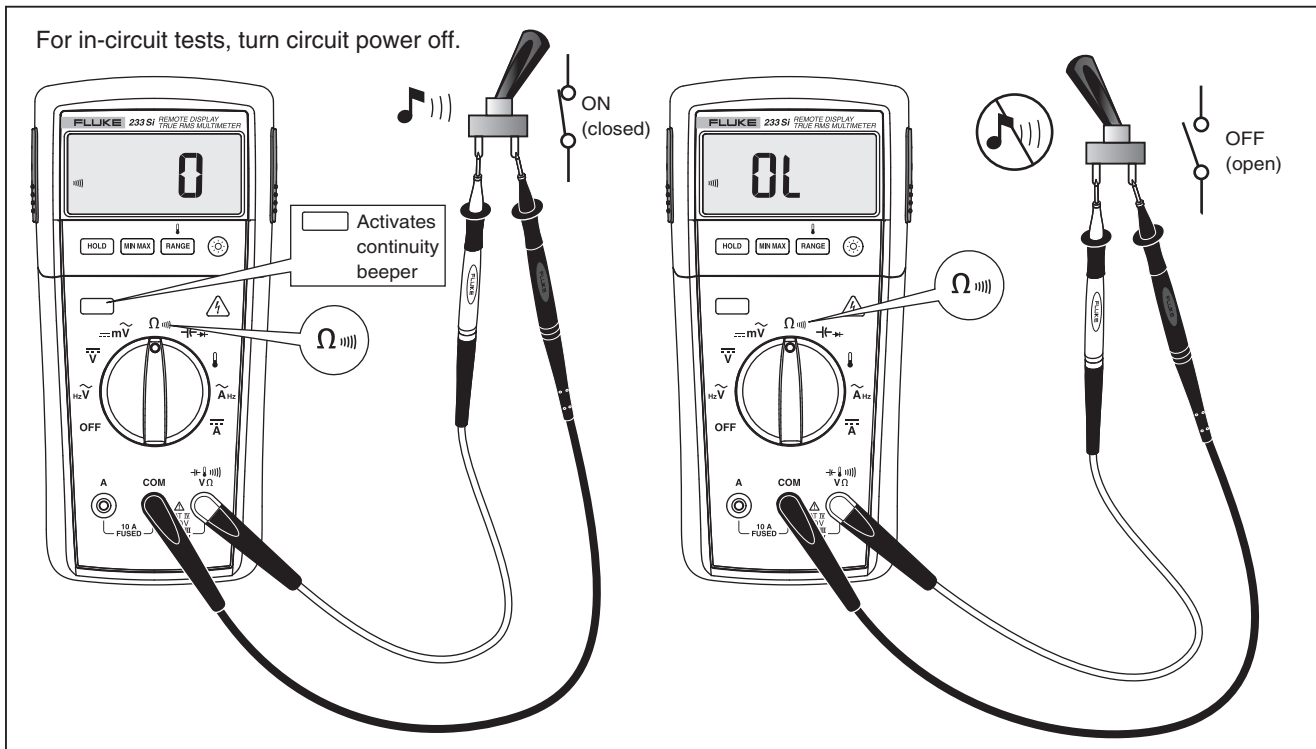

Figure 3. Continuity Tests

gcc103.eps

Diode Tests

⚠ Caution

To prevent possible damage to the Meter or to the equipment under test, disconnect power and discharge all high-voltage capacitors before a diode test.

Do a diode test on diodes, transistors, silicon controlled rectifiers (SCRs), and other semiconductor devices. This function sends a current through the semiconductor junction and then measures the voltage drop across the junction. A good silicon junction drops between 0.5 V and 0.8 V.

To do a diode test on a diode out of a circuit, set up the Meter as shown in Figure 4. For forward-bias measurements on a semiconductor component, put the red test lead on the positive terminal of the component and put the black test lead on the negative terminal of the component.

In a circuit, a good diode has a forward-bias measurement of 0.5 V to 0.8 V. A reverse-bias measurement includes the resistance of other pathways between the probes.

A short beep sounds if the diode is good (<0.85 V). A continuous beep sounds if the measurement is ≤ 0.100 V or short circuit. The display shows "OL" if the diode is open.

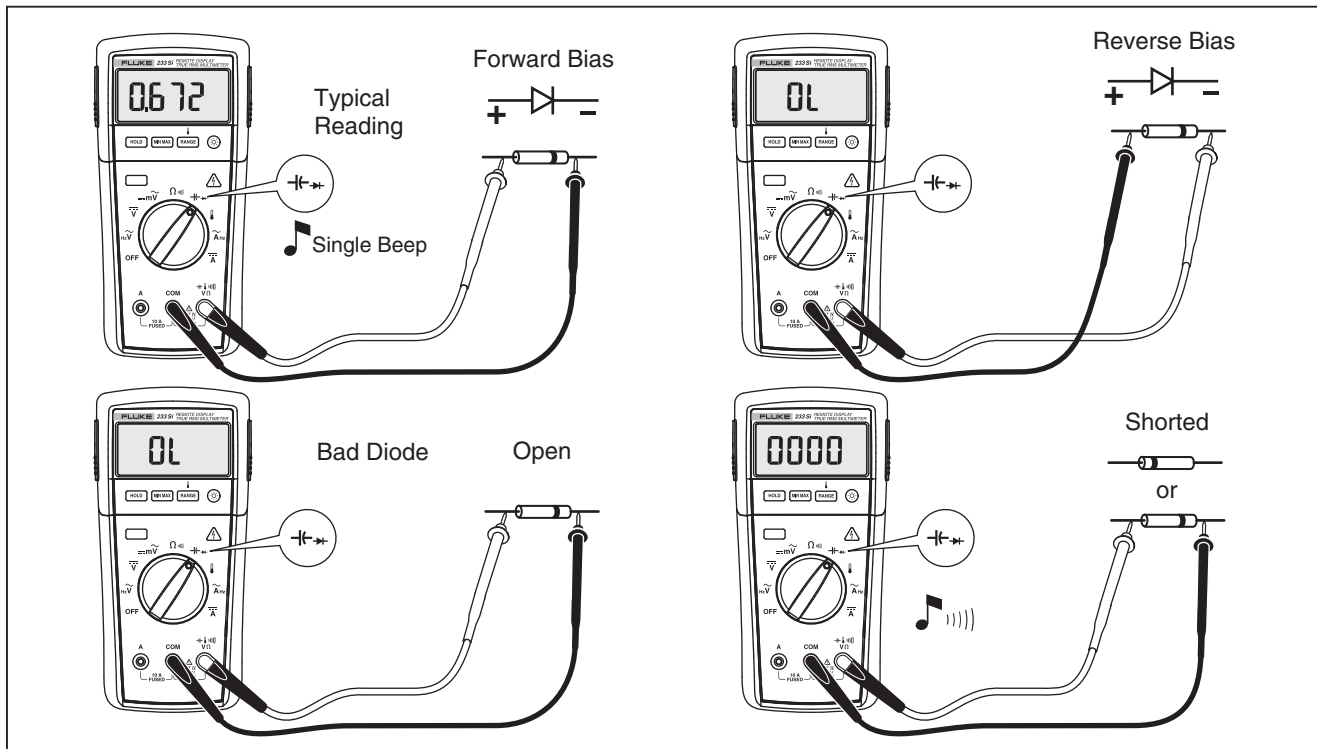

Figure 4. Diode Test

gcc109.eps

Capacitance Measurements

⚠ Caution

To prevent possible damage to the Meter or to the equipment under test, disconnect power and discharge all high-voltage capacitors before capacitance measurements. Use the dc voltage function to make sure that the capacitor is discharged.

Capacitance ranges are 1000 nF, 10.00 μ F, 100.0 μ F, and 9999 μ F.

To measure capacitance, set up the Meter as shown in Figure 5.

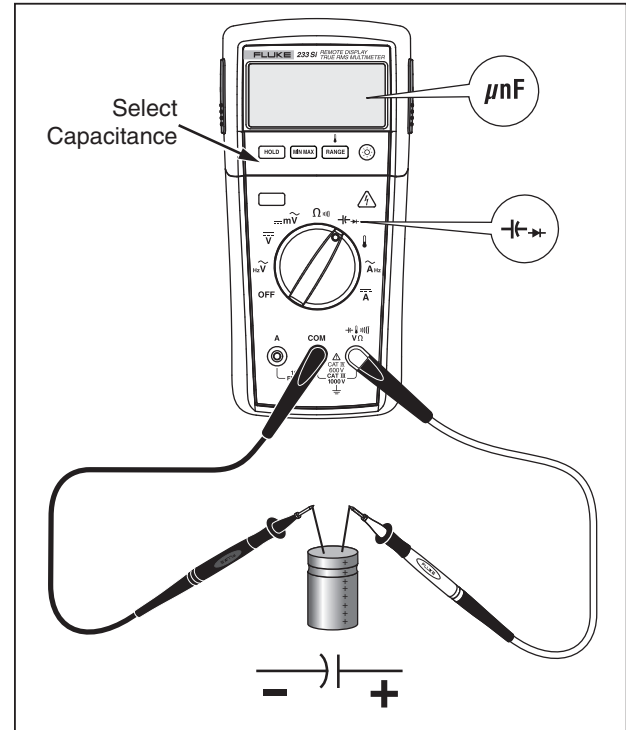

gcc104.eps

Figure 5. Capacitance Measurements

AC and DC Current Measurements

⚠⚠ Warning

To prevent possible electrical shock or personal injury, do not make an in-circuit current measurement where the open-circuit potential to earth is >1000 V. Meter damage or injury can occur if the fuse blows during such a measurement.

⚠ Caution

To prevent possible damage to the Meter or to the equipment under test:

- **Do a fuse test before current measurements.**
- **Use the correct terminals, function, and range for all measurements.**
- **Do not put the probes across (in parallel with) a circuit or component when the test leads are connected to the current terminals.**

To measure current, you must break the test circuit, then put the Meter in series with the circuit.

The current ranges are 6.000 A, and 10.00 A. AC current is shown as an rms value.

To measure current (see Figure 6):

1. Remove power from the circuit. Discharge all high-voltage capacitors.
2. Put the black test lead into the **COM** terminal. Put the red test lead into the **A** terminal.
3. Set the function switch to \tilde{A}_{Hz} for ac current or \overline{A} for dc current.

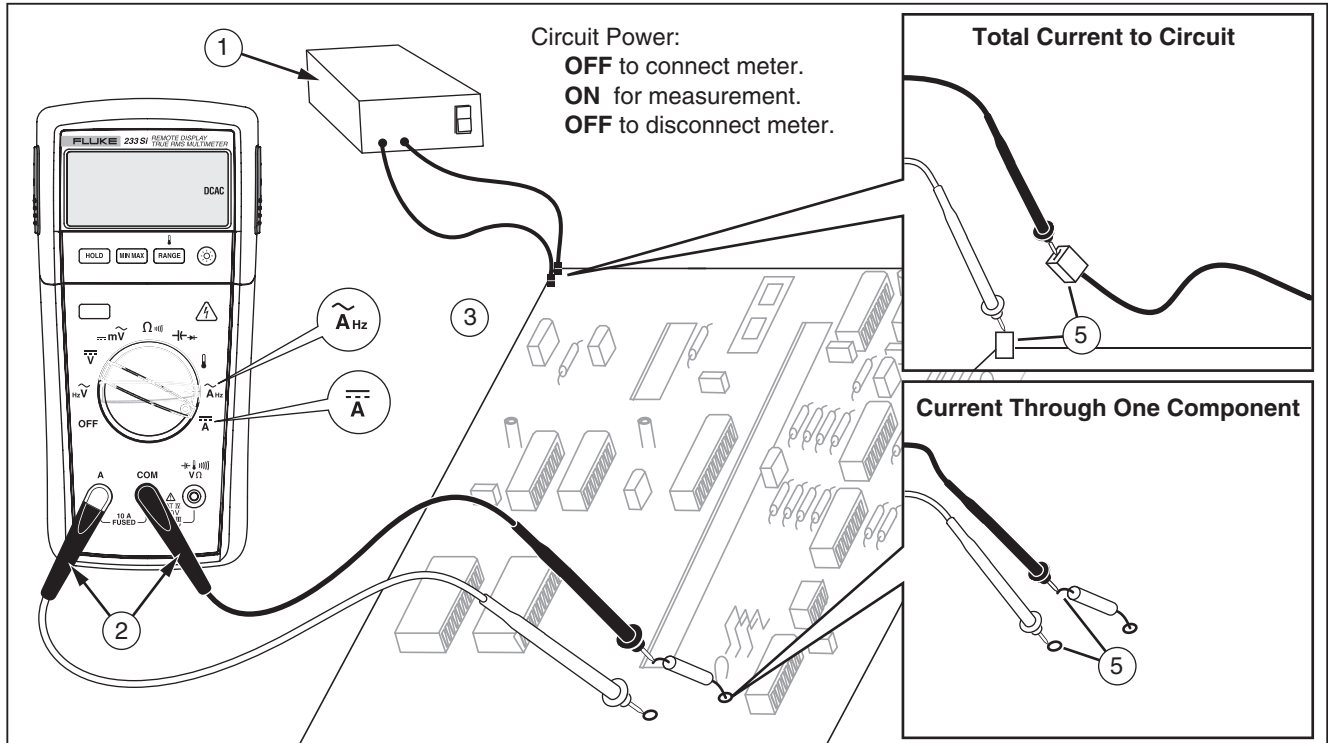

Figure 6. Current Measurements

gcc107.eps

Frequency Measurements

A frequency measurement is a count of the number of times an ac voltage or current signal crosses a threshold point each second.

To make a frequency measurement:

1. Set the function switch to \widetilde{V}_{Hz} for voltage or \widetilde{A}_{Hz} for current.
2. Connect the Meter to the signal source.
3. Push .

The Meter autoranges to one of four frequency ranges: 99.99 Hz, 999.9 Hz, 9.999 kHz, and 50 kHz.

Below are some hints for frequency measurements:

- If a measurement shows as 0 Hz or is not stable, the input signal can be below or near the trigger level. A lower range increases the sensitivity of the Meter and can usually repair these problems.
- An input signal with distortion can cause a frequency measurement to be higher than usual. The distortion can cause multiple triggerings of the frequency counter. A higher voltage range decreases the input sensitivity and can correct this problem. In general, the lowest frequency is the correct one.

Remote Operation

The Meter uses low-power 802.15.4 wireless technology to allow the display module to operate in a different location than the Meter base. Although there is control of some Meter functions (Hold, MIN MAX AVG, Range, and Backlight), complete remote control of the Meter is not available through the display module.

The wireless radio does not interfere with meter measurements. Usually, the radio is off when the display module is docked on the Meter base. It is possible for the radio to be on when the display module is docked and the function switch is set to OFF. To make sure that the radio is off, remove the batteries from the Meter base and display module.

The display module is synchronized with a Meter base when it is docked on the Meter base and turned on. Different display modules can be synchronized with a Meter base but, only one display module can be synchronized to a Meter base at the same time.

Remove the Display Module

To remove the display module (see Figure 7):

1. Push in on the latches on the sides of the display module.
2. Pull the display module off of the top end of the Meter base.

The Meter base and display module can be a maximum of 10 Meters (30 feet) from each other before the radio connection is broken. This distance can change if obstacles are between the Meter base and the display module. There is a radio connection between the display module and Meter base when (()) shows in the display.

When the display module and Meter base lose the radio connection, the display shows dashes and (()) blinks. Possible causes for this loss are the distance is too far for the environment or the batteries in the Meter base are dead. To reconnect, decrease the distance between the display module and Meter base.

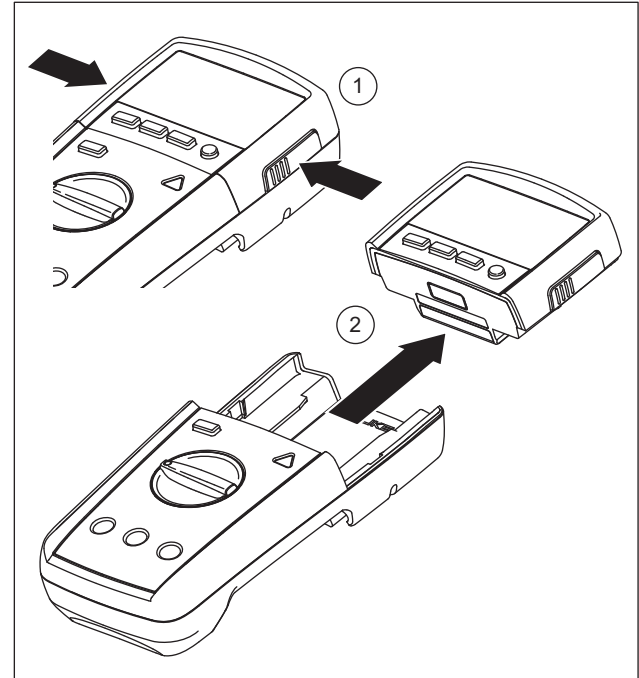

gcc114.eps

Figure 7. Display Module Separation

If the radios in the Meter base and display module do not connect, *rF Err* flashes in the display. Dock the display module with the Meter base and turn the Meter off and then on. When the Meter is turned on, the red high-voltage LED on the Meter base flashes. If not, replace the Meter base batteries. For maximum battery life, dock the display module to the Meter base when the Meter is off.

The display module has a built-in magnet to attach to metal surfaces.

Dock the Display Module with the Meter base

To dock the display with the Meter base as shown in Figure 8:

1. Set the display on the top 10 millimeters of the Meter base with the battery compartment of the display in the channel in the top of the Meter base.
2. Push the display nearer the Meter base until the display latches catch.

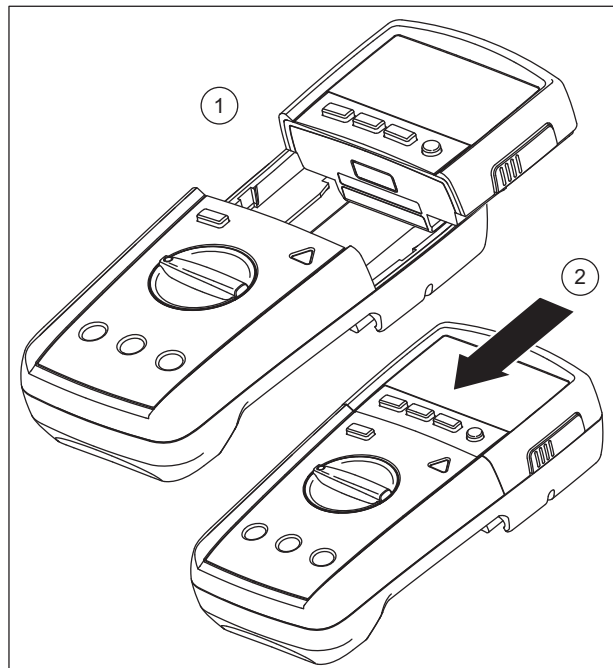

gcc115.eps

Figure 8. Dock Display Module with Meter Base

Maintenance

Warning

To prevent a possible electrical shock or personal injury, have an approved technician repair the Meter.

General Maintenance

Clean the case with a damp cloth and weak detergent. Do not use a solvent or cleaners with abrasives.

Dirt or moisture in the terminals can cause incorrect measurements. To clean the terminals:

1. Turn the Meter off and remove all test leads.
2. Shake out dirt that can possibly be in the terminals.
3. Soak a clean swab with weak detergent and water. Move the swab around in each terminal. Dry each terminal with canned air to push the water and detergent out of the terminals.

Warning

To prevent electrical shock or personal injury, remove the test leads and all input signals before you replace the batteries or fuses. To prevent damage or injury, install ONLY specified replacement parts shown in Table 7.

Battery Replacement

Warning

To prevent incorrect measurements, possible electrical shock, or personal injury, replace the battery when the battery indicator () appears. If the display shows `bAt t d 15P`, the Meter will not function until the display module batteries are replaced. If the display shows `bAt t bA5E`, the Meter will not function until the Meter base batteries are replaced.

There are two low-battery indicators in the display: one for the Meter base batteries and one for the display module batteries. Replace the batteries when the low-battery indicator shows.

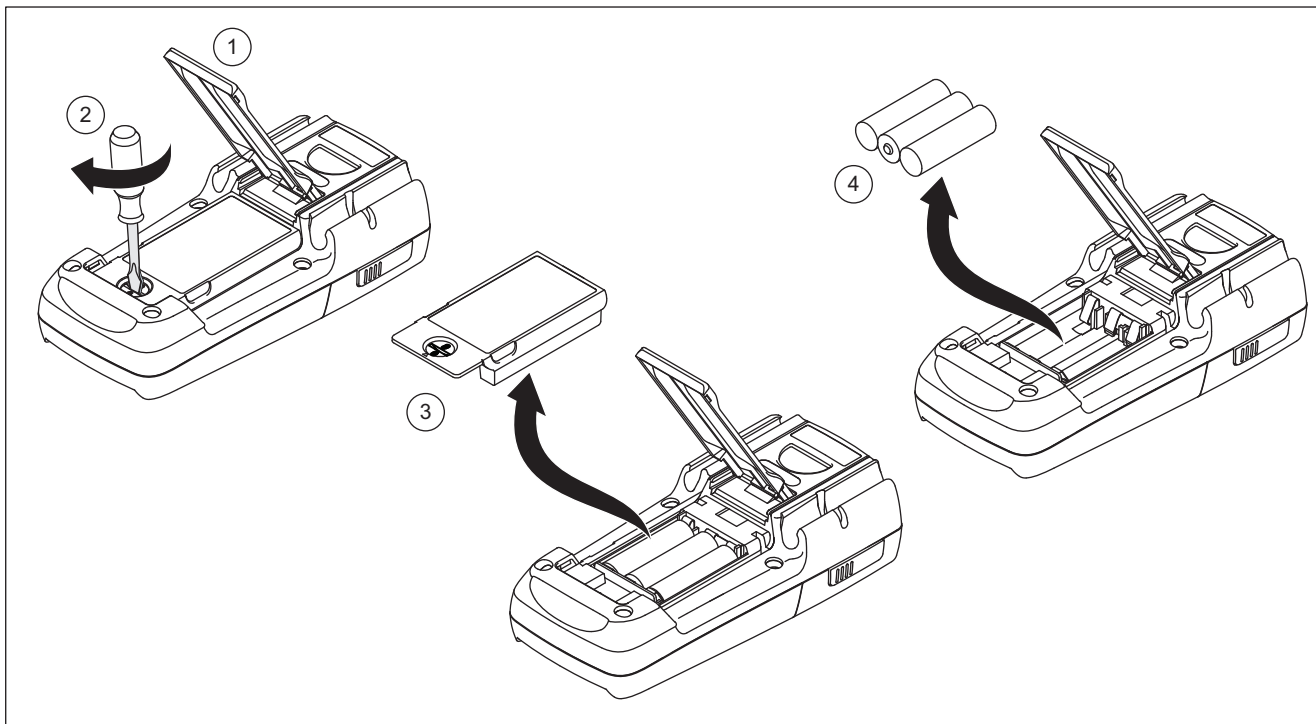

gcc112.eps

Figure 9. Meter Base Battery Replacement

To replace the batteries in the Meter base:

1. Turn the Meter off and remove all test leads.
2. Lift the tilt stand up as shown in Figure 9.
3. Turn the battery-door latch with a standard screwdriver until the unlocked symbol (🔓) aligns with the arrow.
4. Lift off the battery door.
5. Remove the three AA batteries and replace them with new ones. Use the correct battery orientation.
6. Install the battery door.

Turn the battery-door latch until the locked symbol (🔒) aligns with the arrow. When the Meter does not power on, the Meter base batteries or display-module batteries can be dead. To find which of the batteries to replace:

1. Dock the display module with the Meter base.
2. Turn the function switch to off and then on.

If the red high-voltage LED on the Meter base flashes, the Meter base batteries are good. Replace the display-module batteries and turn the Meter on.

To replace the batteries in the display module:

1. Remove the display module from the Meter base. See the “Remove the Display” section.
2. Remove the battery door of the display module as shown in Figure 10.
3. Remove the two AA batteries and replace them with new ones. Use the correct battery orientation.
4. Replace the battery door on the display module.

Dock the display module with the Meter base and turn the Meter on.

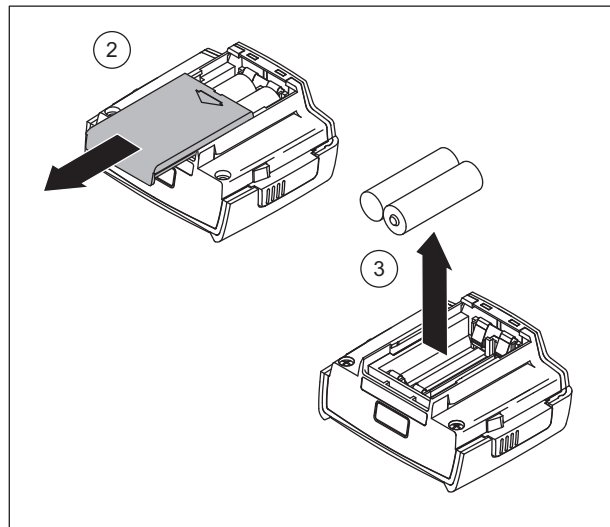

gcc111.eps

Figure 10. Display-Module Battery Removal

Fuse Test

To do a fuse test:

1. Set the function switch to Ω .
2. Connect a test lead to the $\frac{\Omega}{V\Omega}$ jack as shown in Figure 11.
3. Touch the other end of the test lead to the A jack.

A good fuse will show a resistance of 0.5Ω or less. Replace the fuse if the resistance is higher or OL is shown.

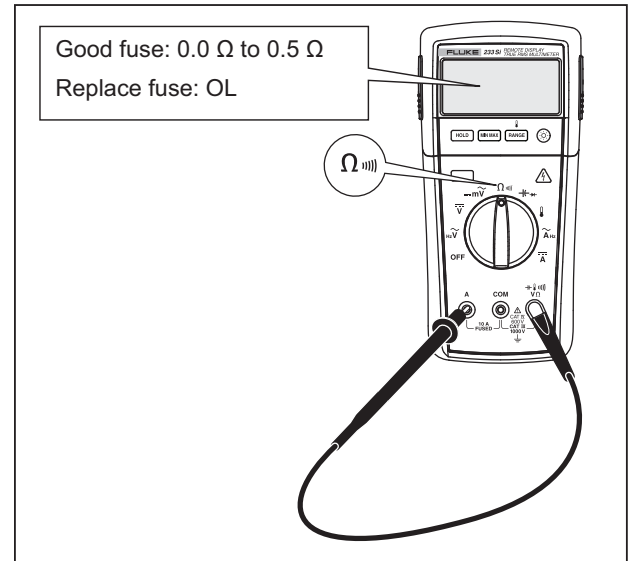

gcc105.eps

Figure 11. Fuse Test

Fuse Replacement

To replace the fuse:

1. Remove the test leads from the Meter.
2. Remove the display module from the Meter base. See the "Remove the Display Module" section.
3. As shown in Figure 12, remove four screws from the case bottom.
4. Pull the case bottom from the case top.
5. Remove the fuse from its holder and replace it with an 11 A, 1000 V, FAST fuse with a minimum interrupt rating of 17,000 A. Use only Fluke PN 803293.

To re-assemble the Meter, do the steps above in the opposite sequence.

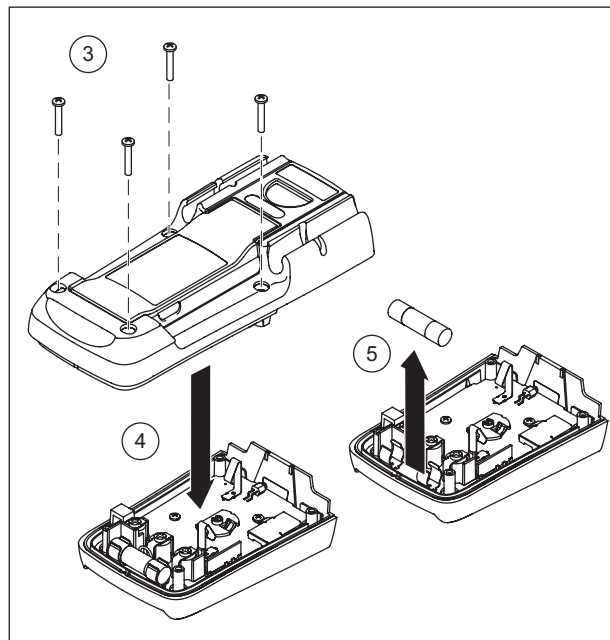

gcc113.eps

Figure 12. Fuse Replacement

Service and Parts

If the Meter fails, replace the battery and do a fuse test. Read this manual to make sure the Meter is applied correctly.

Replacement parts and accessories are shown in Table 7 and Figure 13.

To get parts and accessories, refer to “How to Contact Fluke”.

Table 7. Replacement Parts

Description	Qty.	Fluke Part or Model Number
Battery, AA 1.5 V	5	376756
⚠ Fuse, 11 A, 1000 V, FAST	1	803293
Battery Door – Display Module	1	3383770
Battery Door – Meter Base	1	3383762
233 Display	1	Contact Fluke ^[1]
Alligator Clip, Black	1	AC72
Alligator Clip, Red	1	
Test Lead Set	1	TL75
Integrated DMM Temperature Probe	1	80BK-A
233 Users Manual CD	1	3465353
233 Getting Started Manual	1	3465366
⚠ To ensure safety, use exact replacement only. [1] Contact your local Fluke service center for display replacement.		

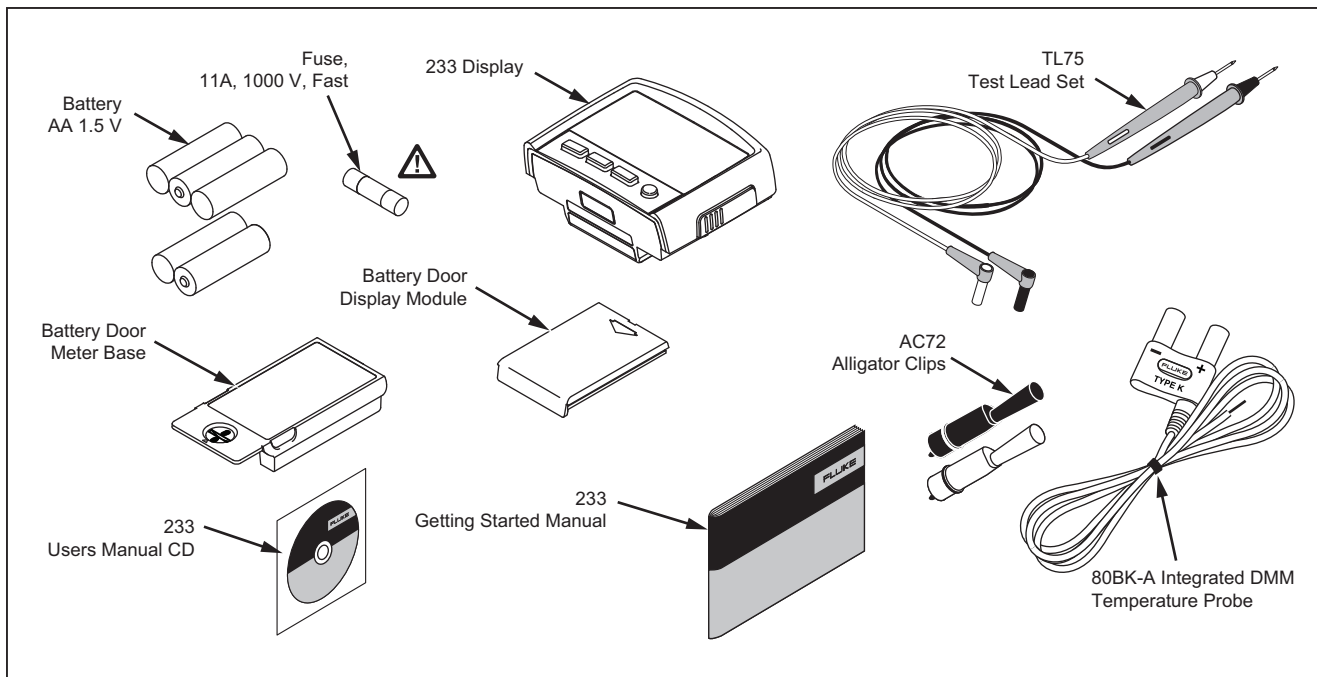

gcc116.eps

Figure 13. Replacement Parts

Table 8. Accessories

Item	Description
TPAK	ToolPak Magnetic Hanger
TL223	SureGrip™ Electrical Test Lead Set
TL220	Industrial Test Lead Set
AC285	SureGrip™ Alligator Clips
AC87	Heavy Duty Bus Bar Clip Set
i400s	AC Current Clamp (requires PM9081 adapter)
PM9081	Dual Banana Plug (male) to Female BNC Adapter
Fluke accessories are available from an approved Fluke distributor.	

General Specifications

Maximum voltage between any

terminal and earth ground 1000 V rms

⚠ Fuse for A inputs 11 A, 1000 V 17000A interrupt rating Fuse

Display 6000 counts, updates 4/sec (Frequency: 9,999 counts, Capacitance: 1,000 counts)

Altitude

Operating 2,000 meters

Storage 12,000 meters

Temperature

Operating -10 °C to +50 °C

Storage -40 °C to +60 °C

Temperature coefficient 0.1 X (specified accuracy) / °C (< 18 °C or > 28 °C)

Electromagnetic Compatibility (EN 61326-1:2006) In an RF field of 3 V/m, accuracy = specified accuracy except in temperature:
specified accuracy ± 5 °C (9 °F)

Wireless Frequency 2.4 GHz ISM Band 10 meter range

Relative Humidity Maximum noncondensing
90 % at 35 °C
75 % at 40 °C
45 % at 50 °C
0 % to 70 % for 40 M Ω range

Battery Type

Meter base Three AA Alkaline batteries, NEDA 15A IEC LR6

Display module Two AA Alkaline batteries, NEDA 15A IEC LR6

Battery Life 400 hrs typical (Alkaline)

Shock 1 Meter drop 6 sides per IEC 61010

Size (H x W x L) 5.3 cm x 9.3 cm x 19.3 cm

Weight 604 g (1.3 lbs)
Safety Compliance Complies with ANSI/ISA S82.01-2004, CSA 22.2 No. 61010-1-04 to 1000 V Measurement Category III and 600 V Measurement Category IV.
Certifications CSA, TÜV (EN61010), CE,  (N10140), VDE, GOST

Detailed Specifications

For all detailed specifications:

Accuracy is specified for 1 yr after calibration, at operating temperatures of 18 °C to 28 °C, with relative humidity at 0 % to 90 %. Accuracy specifications take the form of $\pm([\% \text{ of Reading}] + [\text{Number of least significant digits}])$.

AC Voltage

AC conversions are ac-coupled and valid from 1 % to 100 % of range.

Range ^[1]	Resolution	Accuracy	
		45 – 500 Hz	500 Hz – 1 kHz
600.0 mV	0.1 mV	$\pm(1.0 \% + 3)$	$\pm(2.0 \% + 3)$
6.000 V	0.001 V		
60.00 V	0.01 V		
600.0 V	0.1 V		
1000 V	1 V		
[1] Crest factor of ≤ 3 at 4000 counts, decreasing linearly to 1.5 at full scale.			

DC Voltage, Conductance, and Resistance

Function	Range	Resolution	Accuracy
mV dc	600.0 mV	0.1 mV	±(0.25 % + 2)
V dc	6.000 V	0.001 V	
	60.00 V	0.01 V	
	600.0 V	0.1 V	
	1000 V	1 V	
Ω	600.0 Ω	0.1 Ω	±(0.9 % + 2)
	6.000 kΩ	0.001 kΩ	±(0.9 % + 1)
	60.00 kΩ	0.01 kΩ	
	600.0 kΩ	0.1 kΩ	
	6.000 MΩ	0.001 MΩ	
	40.00 MΩ	0.01 MΩ	±(1.5 % + 2)

Continuity

The beeper is guaranteed on <20 Ω, and guaranteed off >250 Ω, and detects opens or shorts of 500 μs or longer.

Temperature

Range	Resolution	Accuracy ^[1]
-40 °C to +400 °C	0.1 °C	±(1.0 % + 10)
-40 °F to +752 °F	0.1 °F	±(1.0 % + 18)

[1] Temperature uncertainty (accuracy) does not include error of the thermocouple probe.

AC Current

Function	Range	Resolution	Accuracy (45 – 500 Hz)
A ac ^[1,2,3]	6.000 A	0.001 A	±(1.5 % + 3)
	10.00 A	0.01 A	
<p>[1] All ranges are specified from 5 % of range to 100 % of range.</p> <p>[2] Crest factor of ≤3 at 4000 counts, decreasing linearly to 1.5 at full scale.</p> <p>[3] AC current >10 A is unspecified. 20 A continuous overload for 30 seconds maximum.</p>			

DC Current

Function	Range	Resolution	Accuracy
A dc ^[1]	6.000 A	0.001 A	±(1.0 % + 3)
	10.00 A	0.01 A	
<p>[1] DC current >10 A is unspecified. 20 A continuous overload for 30 seconds maximum.</p>			

Capacitance

Range	Resolution	Accuracy
1000 nF	1 nF	$\pm(1.9 \% + 2)$ ^[1]
10.00 μ F	0.01 μ F	
100.0 μ F	0.1 μ F	
9999 μ F	1 μ F	
[1] >1000 μ F: 5 % + 20		

Diode

Range	Resolution	Accuracy
2.000 V	0.001 V	$\pm(0.9 \% + 2)$

Frequency

AC coupled, 5 Hz to 50 kHz, for V ac; dc coupled, 45 Hz to 5 kHz for A ac switch position.

Range	Resolution	Accuracy
99.99 Hz	0.01 Hz	$\pm(0.1\% + 2)$
999.9 Hz	0.1 Hz	
9.999 kHz	0.001 kHz	
50.00 kHz	0.01 kHz	

MIN MAX Recording

Nominal Response	Accuracy
100 ms to 80 %	Specified accuracy ± 12 counts for changes > 200 ms in duration (± 40 counts in ac)

Input Characteristics

Function	Overload Protection	Input Impedance (nominal)	Common Mode Rejection Ratio (1 k Ω unbalance)		Normal Mode Rejection
\bar{V}	1100 V rms	>10 M Ω <100 pF	> 100 dB at dc, 50 Hz or 60 Hz		> 60 dB at 50 Hz or 60 Hz
\tilde{V}	1100 V rms	>5 M Ω < 100 pF	> 60 dB, dc to 60 Hz		
		Open Circuit Test Voltage	Full Scale Voltage		Typical Short Circuit Current
			To 6 M Ω	40 M Ω	
Ω	1100 V rms	<2.7 V dc	<0.7 V dc	<0.9 V dc	<350 μ A
 	1100 V rms	<2.7 V dc	<300 mV dc		<350 μ A
— —	1100 V rms	<2.7 V dc	<700 mV dc		<350 μ A
—> —	1100 V rms	<2.7 V dc	Up to 2.000 V dc		1.2 mA