

**FLUKE**®

# **414D/419D/424D**

Laser Distance Meter

Users Manual

June 2012

© 2012 Fluke Corporation. All rights reserved. Specifications are subject to change without notice.  
All product names are trademarks of their respective companies.

## **LIMITED WARRANTY AND LIMITATION OF LIABILITY**

Each Fluke product is warranted to be free from defects in material and workmanship under normal use and service. The warranty period is three years and begins on the date of shipment. Parts, product repairs, and services are warranted for 90 days. This warranty extends only to the original buyer or end-user customer of a Fluke authorized reseller, and does not apply to fuses, disposable batteries, or to any product which, in Fluke's opinion, has been misused, altered, neglected, contaminated, or damaged by accident or abnormal conditions of operation or handling. Fluke warrants that software will operate substantially in accordance with its functional specifications for 90 days and that it has been properly recorded on non-defective media. Fluke does not warrant that software will be error free or operate without interruption.

Fluke authorized resellers shall extend this warranty on new and unused products to end-user customers only but have no authority to extend a greater or different warranty on behalf of Fluke. Warranty support is available only if product is purchased through a Fluke authorized sales outlet or Buyer has paid the applicable international price. Fluke reserves the right to invoice Buyer for importation costs of repair/replacement parts when product purchased in one country is submitted for repair in another country.

Fluke's warranty obligation is limited, at Fluke's option, to refund of the purchase price, free of charge repair, or replacement of a defective product which is returned to a Fluke authorized service center within the warranty period.

To obtain warranty service, contact your nearest Fluke authorized service center to obtain return authorization information, then send the product to that service center, with a description of the difficulty, postage and insurance prepaid (FOB Destination). Fluke assumes no risk for damage in transit. Following warranty repair, the product will be returned to Buyer, transportation prepaid (FOB Destination). If Fluke determines that failure was caused by neglect, misuse, contamination, alteration, accident, or abnormal condition of operation or handling, including overvoltage failures caused by use outside the product's specified rating, or normal wear and tear of mechanical components, Fluke will provide an estimate of repair costs and obtain authorization before commencing the work. Following repair, the product will be returned to the Buyer transportation prepaid and the Buyer will be billed for the repair and return transportation charges (FOB Shipping Point).

**THIS WARRANTY IS BUYER'S SOLE AND EXCLUSIVE REMEDY AND IS IN LIEU OF ALL OTHER WARRANTIES, EXPRESS OR IMPLIED, INCLUDING BUT NOT LIMITED TO ANY IMPLIED WARRANTY OF MERCHANTABILITY OR FITNESS FOR A PARTICULAR PURPOSE. FLUKE SHALL NOT BE LIABLE FOR ANY SPECIAL, INDIRECT, INCIDENTAL OR CONSEQUENTIAL DAMAGES OR LOSSES, INCLUDING LOSS OF DATA, ARISING FROM ANY CAUSE OR THEORY.**

Since some countries or states do not allow limitation of the term of an implied warranty, or exclusion or limitation of incidental or consequential damages, the limitations and exclusions of this warranty may not apply to every buyer. If any provision of this Warranty is held invalid or unenforceable by a court or other decision-maker of competent jurisdiction, such holding will not affect the validity or enforceability of any other provision.

Fluke Corporation  
P.O. Box 9090  
Everett, WA 98206-9090  
U.S.A.

Fluke Europe B.V.  
P.O. Box 1186  
5602 BD Eindhoven  
The Netherlands

# Table of Contents

Title	Page
Introduction .....	1
How to Contact Fluke .....	1
Safety Information .....	2
Electromagnetic Compatibility (EMC) .....	3
FCC Statement (U.S.A Only).....	3
Laser Classification .....	4
Integrated Distance Meter .....	4
Laser Class 2 Products.....	4
Features .....	5
Before You Start.....	6
Batteries .....	6
Multifunctional Endpiece.....	7
Keypad .....	8
Display.....	9
Button Functions .....	10
On/Off.....	10
Basics .....	10
Units of Measurement .....	11
Timer (419D/424D).....	12
Beeper (419D/424D) .....	12

Backlight (419D/424D).....	12
Keypad Lock (419D/424D).....	12
Compass (424D).....	13
Compass Calibration.....	13
Automatic Calibration.....	13
Manual Calibration.....	13
Magnetic Declination.....	14
Clear.....	16
Measurements with a Tripod.....	16
Reference Point.....	16
Measurements.....	17
Single Distance Measurement.....	17
Minimum/Maximum Tracking.....	17
Addition/Subtraction.....	18
Area.....	18
Volume.....	19
Tilt (424D only).....	20
Smart Horizontal Mode (424D only).....	20
Height Tracking (424D only).....	20
Leveling.....	21
Tilt Sensor Calibration.....	22
Stake Out Measurement (419D/424D).....	23
Corner Angle Measurement (424D only).....	25
Indirect Measurement.....	26
Memory (419D/424D).....	29
Maintenance.....	29
Disable the Meter.....	29
Message codes.....	30
Specifications.....	31

# ***List of Tables***

<b>Table</b>	<b>Title</b>	<b>Page</b>
1.	Symbols.....	2
2.	Model Feature Comparison .....	5
3.	Units of Measurement .....	11
4.	Estimated Values of Magnetic Field .....	15
5.	Message Codes .....	30



# Laser Distance Meter

## Introduction

The Fluke 414D/419D/424D Laser Distance Meters (Meter or Product) are professional-grade laser distance meters. Use these Meters to quickly and accurately get the distance to a target, the area, and the volume measurements.

This Meter is better than an ultrasonic device because it uses laser light waves and measures their reflection. The Meter includes:

- Most advanced technology for distance measurements
- More accurate measurement
- Longer measurement distance – *model dependent*

This manual identifies when a feature is model-dependent. If not identified, all models include the feature.

## How to Contact Fluke

To contact Fluke, call one of the following telephone numbers:

- Technical Support USA: 1-800-44-FLUKE (1-800-443-5853)
- Calibration/Repair USA: 1-888-99-FLUKE (1-888-993-5853)
- Canada: 1-800-36-FLUKE (1-800-363-5853)
- Europe: +31 402-675-200
- Japan: +81-3-3434-0181
- Singapore: +65-6799-5566
- Anywhere in the world: +1-425-446-5500

Or, visit Fluke's website at [www.fluke.com](http://www.fluke.com).

To register your product, visit <http://register.fluke.com>.

To view, print, or download the latest manual supplement, visit <http://us.fluke.com/usen/support/manuals>.

## Safety Information

A **Warning** identifies hazardous conditions and procedures that are dangerous to the user. A **Caution** identifies the conditions and procedures that can cause damage to the Product or cause permanent loss of data.

### Warning

To prevent eye damage and personal injury, do not look into the laser. Do not point the laser directly at persons or animals or indirectly off reflective surfaces.







### Warning

To prevent personal injury:

- Read all safety information before you use the Product.
- Carefully read all instructions.
- Use the Product only as specified, or the protection supplied by the Product can be compromised.
- Replace the batteries when the low battery indicator shows to prevent incorrect measurements.
- Do not use the Product around explosive gas.
- Do not use the Product if it operates incorrectly.
- Do not use and disable the Product if it is damaged.

Table 1 is a list of symbols used on the Product and in this manual.

**Table 1. Symbols**

Symbol	Description
	Battery status.
	Battery or battery compartment.
	Important information. See manual.
	Warning. Laser.
	Conforms to relevant Australian standards.
	Conforms to requirements of European Union and European Free Trade Association.
	Do not dispose of this product as unsorted municipal waste. Go to Fluke's website for recycling information.



### **Electromagnetic Compatibility (EMC)**

The term "electromagnetic compatibility" identifies that the Product operates smoothly in an environment where electromagnetic radiation and electrostatic discharges are present and does not cause electromagnetic interference to other equipment.

#### **⚠ Warning**

**The Product conforms to the most stringent requirements of the relevant standards and regulations. Yet, the possibility that it causes interference in other devices cannot be totally excluded.**

#### **⚠ Caution**

**Never repair the Product yourself. In case of damage, contact Fluke ([www.fluke.com](http://www.fluke.com)).**

### **FCC Statement (U.S.A Only)**

This equipment has been tested and found to comply with the limits for a Class B digital device, pursuant to part 15 of the FCC Rules. These limits are designed to provide reasonable protection against harmful interference in a residential installation.

This equipment generates, uses, and can radiate radio frequency energy and, if not installed and used in accordance with the instructions, may cause harmful interference to radio communications.

However, there is no guarantee that interference will not occur in a particular installation.

If this equipment does cause harmful interference to radio or television reception, which can be determined by turning the equipment off and on, the user is encouraged to try to correct the interference with one or more of these measures:

- Reorient or relocate the receiving antenna.
- Increase the separation between the equipment and receiver.
- Connect the equipment into an outlet on a circuit different from that to which the receiver is connected.
- Consult the dealer or an experienced radio/TV technician for help.

#### **⚠ Warning**

**Changes or modifications not expressly approved by Fluke for compliance could void the user's authority to operate the equipment.**

### Laser Classification

#### Integrated Distance Meter

The Meter produces a visible laser beam from the front of the Meter. Figure 1 shows the warning that is on the back of the Meter.

It is a Class 2 laser product in accordance with IEC60825-1 : 2007 “Radiation safety of laser products.”

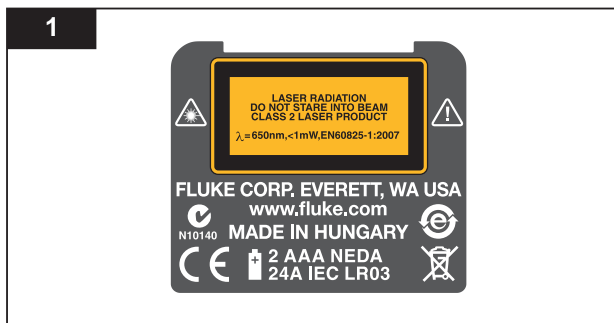

gwo20.gif

### Laser Class 2 Products

Do not stare into the laser beam or direct it towards other people unnecessarily. Eye protection is normally afforded by aversion responses including the blink reflex.

#### Warning

**Do not look directly into the beam with optical aids. Looking directly into the beam with optical aids (for example, binoculars and telescopes) can be hazardous.**

#### Caution

**Looking into the laser beam may be hazardous to the eyes.**

Do not look into the laser beam. Make sure the laser is pointed above or below eye level, particularly with fixed installations in machines and similar setups.

## Features

Table 2 is a list of features for the Meter by model.

**Table 2. Model Feature Comparison**

Feature	414D	419D	424D	Feature	414D	419D	424D
Display Lines	2	3	4	Timer		●	●
Memory <sup>[1]</sup>		20	20	Display/Keypad Illumination		●	●
Add/Subtract	●	●	●	Keypad Lock		●	●
Area	●	●	●	Tripod Measurement		●	●
Volume	●	●	●	Compass			●
Continuous Measurement		●	●	Triangular Area			●
Pythagoras Calculations	1+2	Full	Full	Smart Horizontal Mode (Tilt)			●
Stake Out <sup>[2]</sup>		●	●	Height Tracking			●
Multifunction Endpiece		●	●	Room Corner Angle			●
Beeper		●	●	Handstrap	●	●	●

[1] 419D and 424D store a maximum of 20 complete display readouts.

[2] 419D uses 1 value. 424D uses 2 values.

## Before You Start

This section has basic information about the batteries and measurement reference point. It also describes the Meter keypad and display.

### Batteries

Replace the batteries when  blinks in the display.

To install or replace the batteries:

1. Remove battery compartment lid. See Figure 2.
2. Attach the handstrap.
3. Install two AAA (LR03) batteries with the correct polarity.

#### Note

*Do not use zinc-carbon batteries.*

4. Close the battery compartment.

#### Caution

**To prevent corrosion, remove the batteries before a long period of nonuse.**

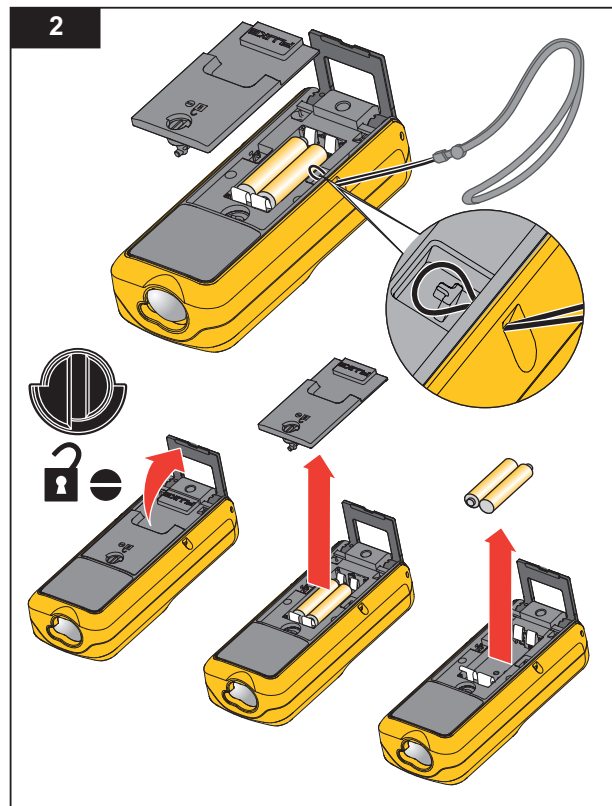

### **Multifunctional Endpiece**

The 419D and 424D Meters adapt to multiple measurement situations with the multifunctional endpiece, see Figure 3:

- For measurements from an edge, fold out the endpiece (90 °) until it locks into place. See Figure 4.
- For measurements from a corner, fold out the endpiece (90 °) until it locks into place. Push the endpiece lightly to the right side to fold it out fully. See Figures 3 and 5.
- A built-in sensor automatically senses the orientation of the endpiece and adjusts the zero point.

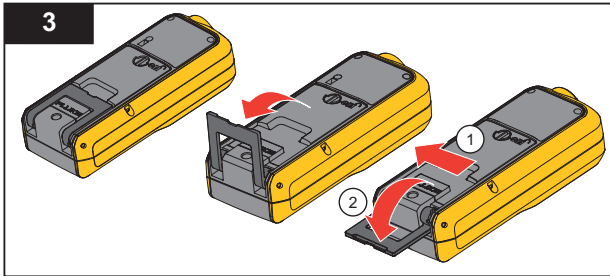

gwo02.eps

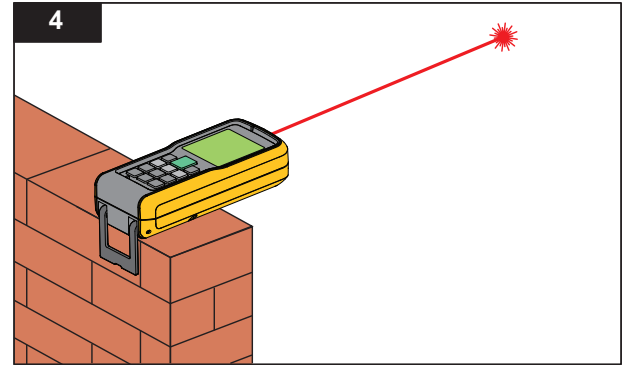

gwo03.eps

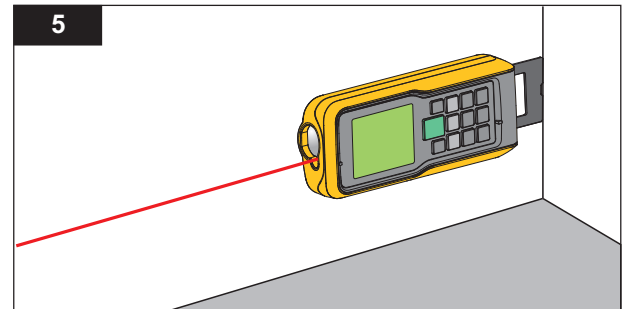

gwo04.eps

**Keypad**

Figure 6 shows the location of each function button on the keypad.

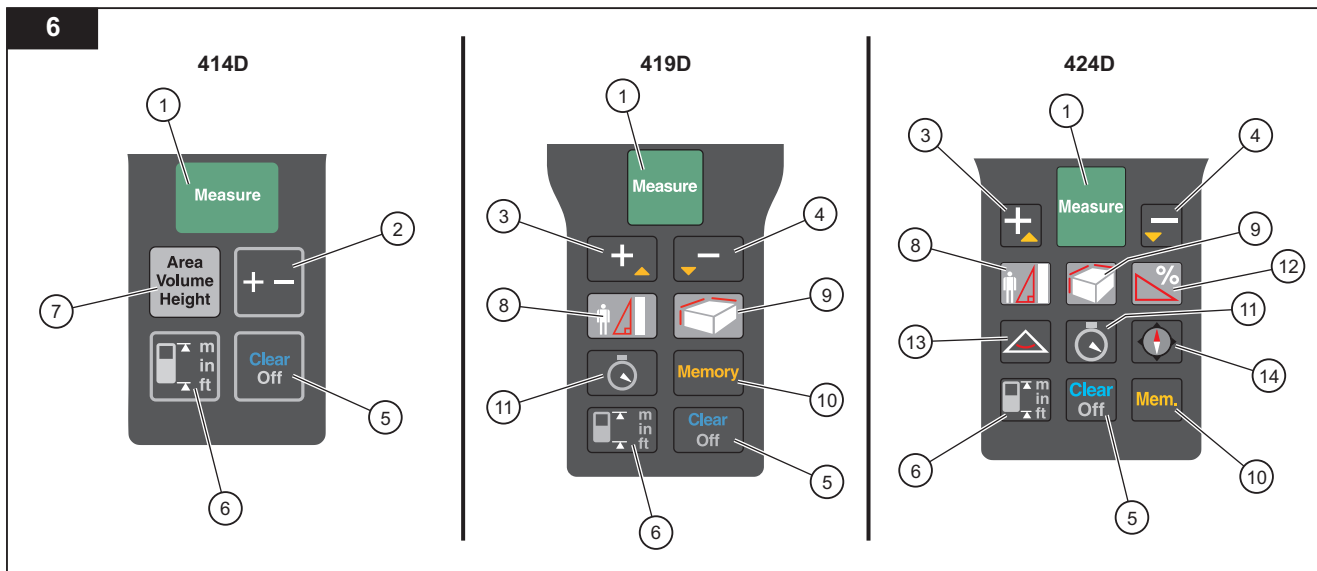

gwo05.eps

- |                         |   |               |            |
|-------------------------|---|---------------|------------|
| ① Measure/Power On      | ⑤ Clear/Off                                       | ⑨ Area/Volume | ⑬ Triangle |
| ② Plus (+)/Minus (-)    | ⑥ Reference/Change Units                          | ⑩ Memory      | ⑭ Compass  |
| ③ Plus (+)/Scroll Up    | ⑦ Area/Volume/Indirect Measurement (Pythagoras)   | ⑪ Timer       |            |
| ④ Minus (-)/Scroll Down | ⑧ Indirect Measurement (Pythagoras and Stake Out) | ⑫ Tilt        |            |

**Display**

Figure 7 shows the readout location on the display for each function.

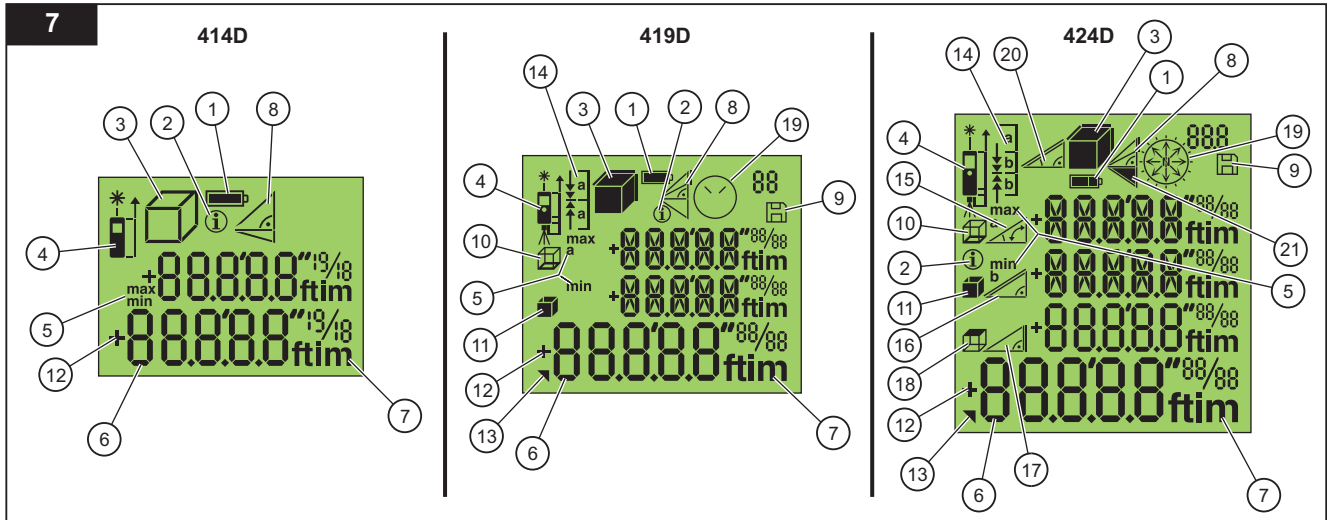

gwo06.eps

- |                                       |                        |                                    |                             |
|---------------------------------------|------------------------|------------------------------------|-----------------------------|
| ① Battery Status                      | ⑦ Units of Measurement | ⑬ 2 <sup>nd</sup> Result Available | ⑲ Timer/Compass (424D only) |
| ② Info                                | ⑧ Pythagoras           | ⑭ Stake Out                        | ⑳ Leveling                  |
| ③ Area/Volume                         | ⑨ Memory               | ⑮ Tilt Angle                       | ㉑ Triangle Area             |
| ④ Measurement Reference               | ⑩ Circumference        | ⑯ Slope Distance                   |                             |
| ⑤ Min/Max Measurement (Tracking Mode) | ⑪ Wall Area            | ⑰ Indirect Height                  |                             |
| ⑥ Measurement Readout                 | ⑫ Addition/Subtraction | ⑱ Ceiling Area                     |                             |

## **Button Functions**

This section is about how to use the buttons and identifies when a function is model-dependent. When not identified, all models include the function.

### **On/Off**

Push  to turn on the Meter and laser. The display shows the battery symbol until you push a different button.

Push  for 2 seconds to turn off the meter.

#### *Note*

*The Meter turns off automatically if not used in 180 seconds.*

## **Basics**

### **414D**

#### **Measure Button**

Push :

- 1x = Laser on
- 2x = Measure

In Pythagoras calculation mode:

- 2 seconds = Tracking (min/max measurement)

#### **Function Buttons**

Push :

- 1x = Area
- 2x = Volume
- 3x = Pythagoras 1
- 4x = Pythagoras 2

### **419D/424D**

#### **Measure Button**

When off, push  for 2 seconds = Continuous Laser On

Push :

- 1x = Laser On
- 2x = Measure
- 2 seconds = Tracking (min/max measurement)

#### **Function Buttons**

Push :

- 1x = Pythagoras 1
- 2x = Pythagoras 2
- 3x = Pythagoras 3
- 4x = Stake Out (419D: 1 value / 424D: 2 values)



Push :

- 1x = Area
- 2x = Volume
- 2 seconds = 2<sup>nd</sup> Results

**424D Only**



Push :

- 1x = Smart Horizontal Mode
- 2x = Height Tracking
- 3x = Leveling



Push :

- 1x = Room Corner Angle (Triangular Area)
- 2 seconds = 2<sup>nd</sup> Results

**Units of Measurement**

Push and hold  (414D) or  (419D/424D) for 2 seconds to toggle between the units for distance measurements, see Table 3.

**Table 3. Units of Measurement**





414D 	419D/424D 
0.000 m	0.000 m
0 00" 1/16*	0.000 <sup>0</sup> m
0 in 1/16	0.00 m
* Default	0.00 ft
	0'00" 1/32*
	0.000 in
	0 in 1/32

\* Default

#### Timer (419D/424D)

Fluke recommends that you use a time-delay for the most accurate measurements at long distances. This prevents Meter movement when you push .

To turn on the timer:



1. Push  1x to turn on the 5-second timer. This is the default time interval to release the laser for a measurement.
2. Push  to increase up to 60 seconds.
3. Push  to decrease the seconds.
4. Push  to begin the timer.

The seconds until measurement (for example, 59, 58, 57...) show as a countdown. The last 5 seconds count down with a beep. After the last beep, the Meter makes the measurement and the value shows on the display.



#### Note

*The timer is useful for all measurements.*

#### Beeper (419D/424D)

Push   at the same time for 2 seconds to turn on and turn off the beeper. The display shows the status as BEEP On or BEEP OFF.

#### Backlight (419D/424D)



Push   at the same time for 2 seconds to turn on and turn off the backlight. The display shows the status as ILLU On or ILLU OFF.

#### Keypad Lock (419D/424D)

To lock:

1. Push   at the same time to lock the keypad.

To unlock:

1. Push .
2. Push  within 2 seconds to unlock the keypad.

### **Compass (424D)**

The compass feature lets you know the view or direction as you make measurements. This is useful indoors to set the building plans in the correct direction. It is also useful to know the correct direction when you calculate the efficiency for a solar panel.

Tips:

- Make sure that the endpiece is folded in.
- When you use the compass feature, the Meter shows the calibration message. See *Compass Calibration* for more information.
- Compass arrows blink on the display if the Meter is tilted  $>20^\circ$  end to end or  $>10^\circ$  side to side.
- When you turn on the compass, the Meter shows the calibration message. See *Manual Calibration* for more information.

Push :

- 1x = Arrow points in north direction
- 2 seconds = Arrow points in direction of Laser beam and display shows the direction in degrees and an alpha symbol.

#### **Caution**

**To prevent incorrect direction readouts, do not use near magnets and magnetic devices.**



### **Compass Calibration**

#### **Automatic Calibration**

The compass sensor continuously collects and saves new calibration values in 60-second intervals.

#### **Manual Calibration**

When you turn on the compass, the Meter shows the calibration message:

1. For no, push . The compass uses old data that can be inaccurate.
2. For yes, push .

To continue with the calibration:

3. Rotate the Meter  $180^\circ$  around the Z-axis. See Figure 8.
4. Rotate the Meter  $180^\circ$  around the X-axis.
5. Rotate the Meter  $180^\circ$  around the Y-axis.

The Meter counts from 1 to 12 during calibration. COMPA OK shows on the display when the calibration is complete.

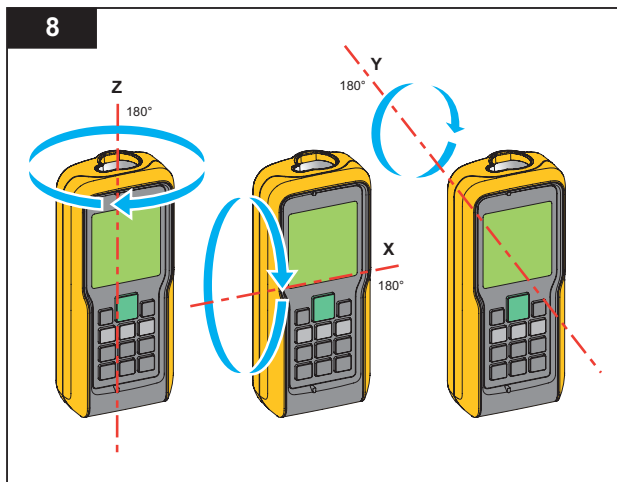

### *Magnetic Declination*

The difference between the north geographic pole and the north magnetic pole is known as magnetic declination, or more plainly, declination. The angle of declination is different at different locations on the earth. The geographic and magnetic poles are aligned so declination is minimal. From some locations, the angle between the two poles can be fairly large.

Table 4 is a list of the current angles of declination by location. For other declination values, contact your local Geomagnetic Institute.

To set the Meter with the correct compensation for your location:

1. Push **Mem.** **+** at the same time.

The display shows **dDECLI** and the current setting. The default value is  $0^\circ$ .

2. Push **+** and **-** to change the value.
3. Push **Measure** to accept the new value.

**Table 4. Estimated Values of Magnetic Field**

<b>Country</b>	<b>City</b>	<b>Declination in Degrees (+E   -W)</b>	<b>Country</b>	<b>City</b>	<b>Declination in Degrees (+E   -W)</b>	<b>Country</b>	<b>City</b>	<b>Declination in Degrees (+E   -W)</b>
Argentina	Buenos Aires	-7	Greenland	Godthab	-29	Spain	Madrid	-1
Australia	Darwin	3	Iceland	Reykjavik	-15	Switzerland	Zurich	1
Australia	Perth	-1	Italy	Rome	2	Thailand	Bangkok	0
Australia	Sidney	12	India	Mumbai	0	Ukraine	Donetsk	7
Austria	Vienna	3	Japan	Tokyo	-7	UAE	Dubai	1
Brazil	Brasilia	-20	Kenya	Nairobi	0	United Kingdom	London	-1
Brazil	Rio de Janeiro	-22	Norway	Oslo	2	USA	Anchorage	18
Canada, BC	Vancouver	17	Panama	Panama	-3	USA	Dallas	3
Chili	Santiago de Chile	2	Russia	Irkutsk	-3	USA	Denver	8
China	Beijing	-6	Russia	Moscow	10	USA	Honolulu	9
Egypt	Cairo	3	Russia	Omsk	11	USA	Los Angeles	12
France	Paris	0	Senegal	Dakar	-8	USA	Miami	-6
Germany	Berlin	2	Singapore	Singapore	0	USA	New York	-13
Greece	Athens	3	South Africa	Cape Town	-24	Venezuela	Caracas	-11

### Clear

Push  :

- 1x = Clear last value
- 2x = Clear all
- 2 seconds = Turn off Meter



### Measurements with a Tripod

Measurements with the 419D and 424D that use a tripod must have the tripod reference set. When set,  shows on the display.

### Reference Point

The display shows the reference point for a measurement. The default reference point is from the end of the Meter. If the beeper is on, the Meter beeps as you change the reference point. See Figure 9 for more information.



#### 414D

Push  1x to change the reference point between the front and the end of the Meter. The display shows  or .

#### 419D/424D

The Meter automatically adjusts the reference point when you use the endpiece and  shows on the display.

Push  :

- 1x = Measure from front 
- 2x = Measure from tripod screw 
- 3x = Measure from end 

#### Note

*The tripod mode overrides other reference points. The Meter stays in the tripod mode until you change to a different reference point.*

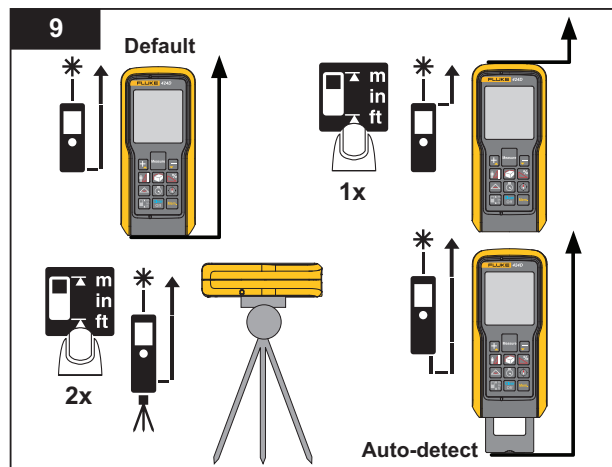



gwo07.eps

## Measurements

The Meter measures the distance to a target, the area bounded by two distances, or the volume in three measurements. This manual identifies when a feature is model-dependent. When not identified, all models include the feature.

### Single Distance Measurement

To measure distance:

1. Push  to turn on the laser.
2. Push  again to make the distance measurement.

The measurement shows on the display.

#### Note

*Measurement errors can occur if you point the laser at colorless liquids, glass, Styrofoam, semi-permeable surfaces, and high-gloss surfaces. The measurement time increases when you point the laser at dark surfaces.*

A target plate is useful for long distance measurements if the target reflectivity and illumination is a problem.

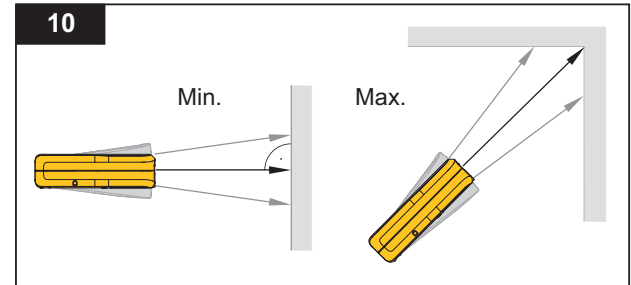

### Minimum/Maximum Tracking

The tracking function measures the room diagonal (maximum value) and the horizontal distance (minimum value) from a stable measurement point. It also can find the distance between objects. See Figure 10.



gwo08.eps

To measure:

1. Push and hold  for 2 seconds.  
→\* shows on the display to confirm that the Meter is in tracking mode.
2. Move the laser side to side, up and down on the target area (for example, into the corner of a room).
3. Push  to stop tracking mode.

The last measured value shows in the summary line.

#### Note

*419D/424D Only: The values for maximum and minimum distances show in the display. The last measured value shows in the summary line.*

### Addition/Subtraction

The Meter adds and subtracts a value to a single distance, area, and volume measurements.

#### 414D



To add or subtract:

Push :

- 1x = Add the next measurement
- 2x = Subtract the next measurement

#### 419D/424D





To add or subtract:

1. Push  to add the next measurement to the previous measurement.
2. Push  to subtract the next measurement from the previous measurement.
3. Do these steps again for each measurement.  
The total measurement result is always shown in the summary line with the value before in the second line.
4. Push  to cancel the last step.

### Area

To measure area:





#### 414D

1. Push  1x. The  symbol appears in the display.
2. Push  to make the first measurement (for example, length).
3. Push  again to make the second measurement (for example, width).

The result shows in the summary line.

#### 419D/424D

To measure area:

1. Push  1x. The  symbol shows in the display.
2. Push  to make the first measurement (for example, length).
3. Push  again to make the second measurement (for example, width).

The result shows in the summary line.





4. Push  and hold for 2 seconds to get the 2<sup>nd</sup> result as a circumference.



## Volume

### 414D





To measure volume:

1. Push  2x. The  symbol shows in the display.
2. Push  to make the first length measurement (for example, length).
3. Push  again to make the second length measurement (for example, width).
4. Push  again to make the third length measurement (for example, depth).

The result displays in the summary line.

### 419D/424D

To measure volume:

1. Push  2x. The  symbol appears in the display.
2. Push  to make the first measurement (for example, length).
3. Push  again to make the second measurement (for example, height).
4. Push  again to make the third length measurement (for example, depth).

The result shows in the summary line.

5. Push  x 2 seconds to show additional room information such as ceiling/floor area, surface area of the walls, circumference.

 Ceiling/floor area (424D)

 Wall area (419/424)

 Circumference (419D/424D)

**Tilt (424D only)****Note**





The inclinometer senses tilts at  $360^\circ$ . For tilt measurements, hold the Meter without a transverse tilt ( $\pm 10^\circ$ ).

**Smart Horizontal Mode (424D only)**

The Smart Horizontal mode (indirect horizontal distance) function lets you find a horizontal distance when the line-of-sight is blocked by an object or obstacle. See Figure 11 for more information.

The tilt is continuously shown as  $^\circ$  or  $\%$ . To change the units, push and hold **Mem.** **%** at the same time for 2 seconds. The default unit is  $^\circ$ .

To measure:

1. Push **%** 1x = Smart Horizontal Mode.  shows in the display.
2. Point laser at target.
3. Push **Measure**. The display shows all results as  $\alpha$  (angle ) , x (diagonal distance ) , and y (vertical distance ). The z (horizontal distance) shows in the summary line.
4. Push **%** to turn off Smart Horizontal Mode.

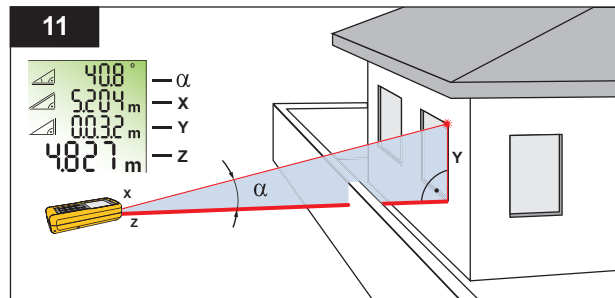



gwo09.eps

**Height Tracking (424D only)**

Height tracking shows continuously on the display as the Meter turns on a tripod. The tilt is continuously shown in the selected unit of measure as  $^\circ$  or  $\%$ .

To measure:

1. Push **%** 2x = Height tracking.  shows in the display.
2. Point the laser at lower target.
3. Push **Measure**.  shows in the display with the distance and angle to the lower target.
4. Move the laser upwards to the top target. Height Tracking starts automatically. The display shows the angle to the actual target and the vertical distance from the lower target.

5. Push  at the top target. Height Tracking stops and the display shows the vertical distance between the two measured targets. See Figure 12 for more information.

*Note*

*The minimum/maximum tracking is very helpful for 90 ° angle measurements. See page 17 for more information.*

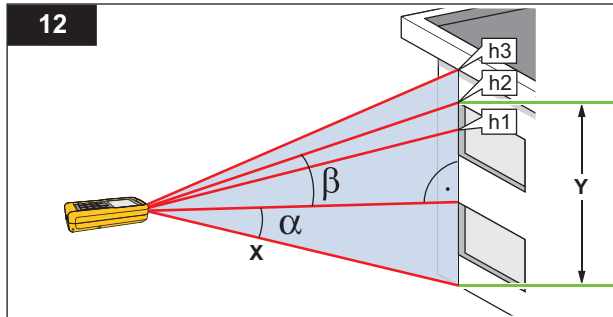

gwo10.eps

**Leveling**

The Leveling function continuously shows the angle of the Meter. From an angle of  $\pm 5^\circ$ , the Meter starts to beep. As it gets near  $\pm 1^\circ$ , the Meter beeps faster. At  $\pm 0.3^\circ$ , the Meter beeps constantly.

To level:

1. Push  3x = Leveling.  $\sphericalangle$  shows in the display.
2. Put the Meter on object to do a test for level.

The angle continuously shows on the display as the object moves.

**Tilt Sensor Calibration**

To calibrate the tilt sensor:

1. Push **Clear Off** **%** at the same time for 2 seconds.

The display shows **CAL** message and the instructions for the first measurement. See Figure 13.

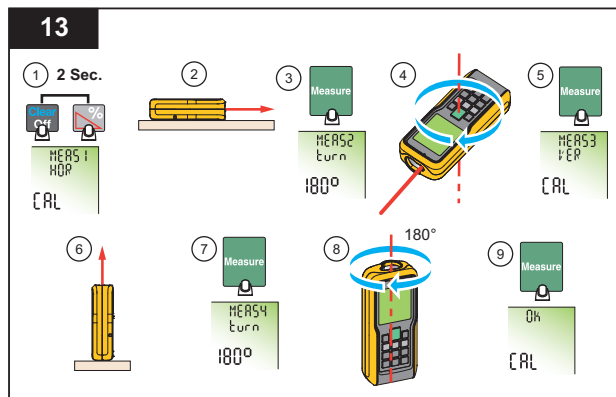

gwo23.eps

2. Put the Meter on a flat horizontal surface.
3. Push **Measure**.

The display shows the instructions for the subsequent measurement.

4. Turn the Meter horizontally 180 ° on the same flat horizontal surface.

5. Push **Measure**.

The display shows the instructions for the subsequent measurement.

6. Put the Meter upright on a flat horizontal surface.

7. Push **Measure**.

The display shows the instructions for the subsequent measurement.

8. Turn the upright Meter 180 ° on the same flat surface.

9. Push **Measure**.

The display shows the calibration results as **OK CAL**.

### Stake Out Measurement (419D/424D)

A specific distance can be set in the Meter and used to mark off defined measured lengths. An example of this application is in the construction of wooden frames. See Figure 14 for more information.

#### Note

*For best results, it is recommended to use the end reference point for a stake out measurement. See page 16 for more information.*

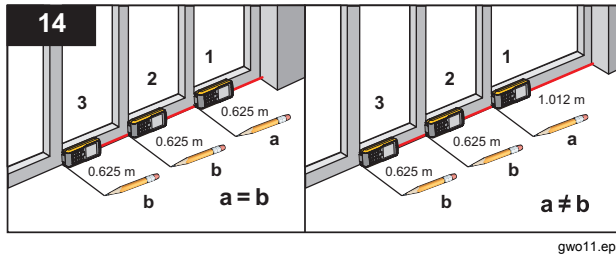

### 419D (1 Value)

To find stake out distances with 1 value:

1. Push 4x. shows on the display.
2. Push and to increase and decrease the value that shows in the summary line.

#### Note

*Hold the buttons down to increase the rate of change for the values.*

3. Push to accept the value.

The display shows the stake out distance in the summary line between the stake out point and the Meter (rear reference).

4. Move the Meter slowly along the stake out line and the distance decreases on the display.

The arrows in the display indicate in which direction the Meter needs to be moved in order to achieve the defined distance.

#### Note



*If the beeper feature is on, the Meter starts to beep at a distance of 0.1 m (4 in) from the next stake out point. As the Meter moves near to the stake out point, the beep changes and the arrows do not show on the display.*

5. Push to stop the stake out function.

**424D (2 Values)**

You can enter two different distances (a and b) into the Meter and use them to mark off measured lengths, for example, in the construction of wooden frames.

To find stake out distances with 2 values:





1. Push  4x.  $\frac{T}{S}$  shows in the display.
2. Push  and  to increase and decrease the values that shows on the display.

The value (a), and the intermediate line that corresponds, blink on the display.

3. Push  and  to adjust the (a) value.

*Note*

*Hold the buttons down to increase the rate of change for the values.*

4. Push  to accept the (a) value.
5. Push  and  to adjust the (b) value.
6. Push  to accept the (b) value.

The display shows the stake out distance in the summary line between the stake out point (a and then b) and the Meter (rear reference).

7. Move the Meter slowly along the stake out line the displayed distance decreases.

The arrows in the display  $\frac{T}{S}$  indicate in which direction the Meter needs to be moved in order to achieve the defined distance (either a, or b).

*Note*





*If the beeper feature is on, the Meter starts to beep at a distance of 0.1 m (4 in) from the next stake out point. As the Meter moves near to the stake out point, the beep changes and the arrows do not show on the display.*

8. Push  to stop the stake out function.

**Corner Angle Measurement (424D only)**

The Meter calculates the angles in a triangle with measurements from the three sides. As an example, use this function with a right-angle room corner. See Figure 15 for more information.

To make corner angle measurements:

1. Push  1x.  (room corner) shows in the display.
2. Put marks for the reference points to the right and left (d1/d2) of the angle for measurement.
3. Push  to make a measurement of the first side of the triangle (d1 or d2).
4. Push  to make a measurement of the second side of the triangle (d1 or d2).
5. Push  to make a measurement of the third side of the triangle (d3).
6. The result shows in the summary line as the room triangle area.

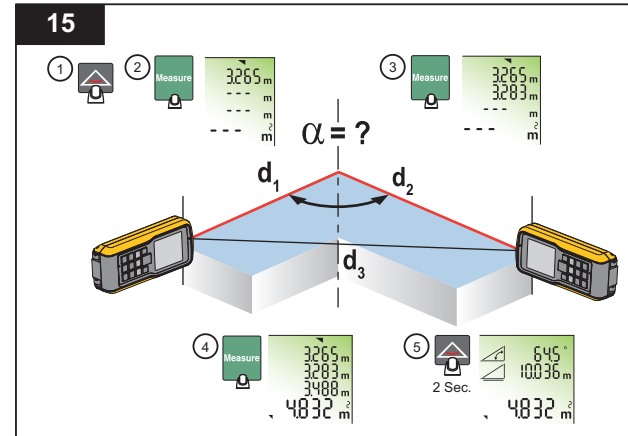

gwo12.eps

7. Push  for 2 seconds to get the second results as the angle between  $d_1$  and  $d_2$ , the triangle circumference, and the area.

### Indirect Measurement

The Meter can calculate distances with Pythagoras' theorem. With this function, you can find a distance with two auxiliary measurements, such as building height or width measurements. It is helpful to use a tripod for a height measurement that uses two or three measurements.



#### Note

*Make sure that you use the correct sequence of measurement:*

- *All target points must be in a horizontal or vertical plane.*
- *For the best results, turn the Meter about a set point. An example of this is with the endpiece fully open and the Meter on a wall.*
- *Make sure that the first measurement and the measurement distance are at  $90^\circ$  angles.*
- *The minimum/maximum tracking is very helpful for  $90^\circ$  angle measurements. See page 17 for more information.*

### 414D

To find a vertical distance with two measurements (Pythagoras 1):

1. Push  3x.  shows on the display.
2. Point the laser at the first target (1). See Figure 16.
3. Push  for the first distance (diagonal) measurement.
4. Point the laser at the second target (2).

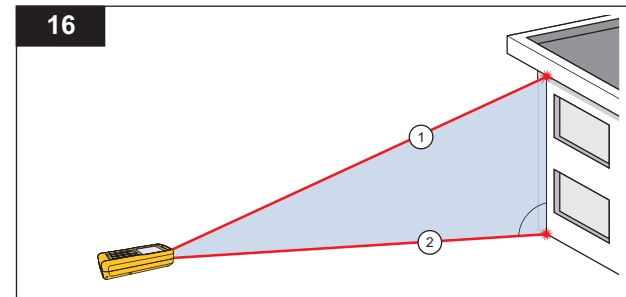





gwo13.eps

5. Make sure that the Meter is perpendicular to the wall.
6. Push  for the second distance measurement.

The Meter shows the height in the summary line. The distance of the second measurement shows in the secondary line.



To find a total distance with three measurements (Pythagoras 2):

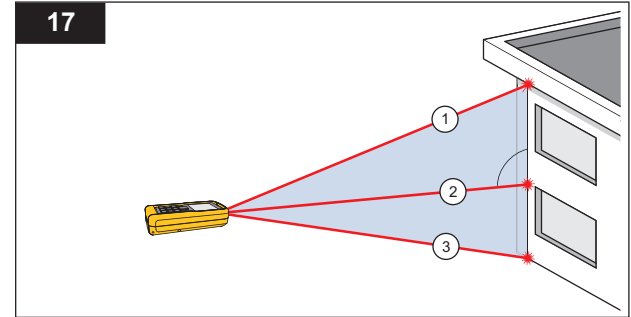

1. Push  4x.  shows on the display.
2. Point the laser at the first target (1). See Figure 17.
3. Push  for the first distance (diagonal) measurement.
4. Point the laser at the second target (2).
5. Make sure that the Meter is perpendicular to the wall.
6. Push  for the second distance.
7. Point the laser at the third (3) target.
8. Push  for the third distance measurement.

The Meter shows the height in the summary line. The distance is the total vertical height from the first to last targets. The third measurement shows in the secondary line.







gwo14.eps

As an option, use the tracking mode on one or more targets. To use tracking mode:

1. Push and hold  for 2 seconds to start tracking mode.
2. Move the laser side to side and up and down on the ideal horizontal target point.
3. Push  to stop the tracking mode.





**419D/424D**

To find a distance with two measurements (Pythagoras 1):

1. Push  1x.  shows on the display.
2. Point the laser at the top point (1). See Figure 16.
3. Push .
4. Point the laser at the second target (2).
5. Make sure that the Meter is perpendicular to the wall.
6. Push .

The Meter shows the height in the summary line. The distance of the second measurement shows in the secondary line.



To find a total distance with three measurements (Pythagoras 2):

1. Push  2x.  shows on the display.
2. Point the laser at the first target. See Figure 17.
3. Push  for the first distance (diagonal) measurement.
4. Point the laser at the second target (2).
5. Make sure that the Meter is perpendicular to the wall.
6. Push .

7. Point the laser at the third (3) target.
8. Push .



The Meter shows the result in the summary line. The measured distance to the subsequent measurement shows in the second line.

To find a partial distance, see Figure 18, with three measurements (Pythagoras 3):

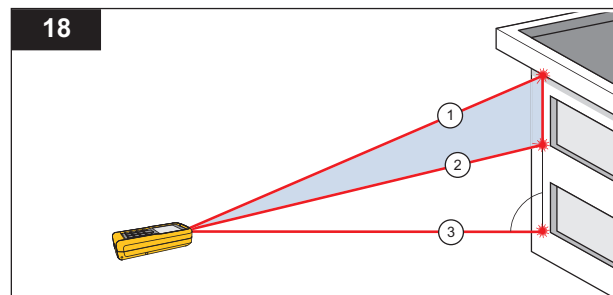
1. Push  3x. The laser turns on and  shows on the display.
2. Point at the top target (1).





gwo15.eps

3. Push . The Meter stores this measurement value.
4. Point the laser at the second diagonal target (2).
5. Push .

6. Make sure that the Meter is perpendicular to the wall.
7. Push  to trigger the bottom target (3) measurement.

The result is the partial vertical distance between target 1 and target 2. The third measurement shows in the secondary line.

As an option, use the tracking mode on one or more targets. To use tracking mode:

1. Push and hold  for 2 seconds to start tracking mode.
2. Move the laser side to side and up and down on the ideal horizontal target point.
3. Push  to stop the tracking mode.

### **Memory (419D/424D)**

You can recall a previous measurement from memory, for example, the height of a room. The Meter stores a maximum of 20 displays.

To recall:

1. Push  1x.
2. Push  and  to move through the stored displays.

 and the memory ID show on the display.

3. Push  for 2 seconds to use the value shown in the Summary line for further calculations.

To delete:

1. Push  and  at the same time.

The Meter deletes all the stored values in memory.

### **Maintenance**

Maintenance and calibration is not necessary for the Meter. To keep the Meter in good condition:

- Remove dirt with a moist, soft cloth.
- Do not put in water.
- Do not use aggressive detergents or solutions.

### **Disable the Meter**

If damaged, do not use and disable the Meter. To disable, remove the batteries. See page 6 for more information.

## Message codes

Table 5 is a list of all message codes that show on the display with **InFo** or **Error**.

**Table 5. Message Codes**

<b>Code</b>	<b>Cause</b>	<b>Remedy</b>
<b>156</b>	Transverse tilt greater than 10 °	Hold the Meter without a transverse tilt.
<b>162</b>	Calibration mistake	Make sure that the device is on a horizontal and flat surface. Do the calibration procedure again. If the code continues, contact Fluke.
<b>204</b>	Calculation error	Do the measurement again.
<b>252</b>	Temperature too high	Let the Meter cool down.
<b>253</b>	Temperature too low	Let the Meter warm up.
<b>255</b>	Received signal too low, measurement time too long	Change target surface (for example, white paper).
<b>256</b>	Received signal too high	Change target surface (for example, white paper)
<b>257</b>	Too much background light	Darken target surface.
<b>258</b>	Measurement outside of measurement range	Correct the range.
<b>260</b>	Laser beam interrupted	Do the measurement again.
<b>Error</b>	Hardware error	Turn on and turn off the device 2 to 3 times. If the symbol stays on the display, then your Meter is defective, contact Fluke.

## Specifications

	414D	419D	424D
<b>Distance Measurement</b>			
Typical Measurement Tolerance <sup>[1]</sup>	± 2.0 mm (± 0.08 in) <sup>[3]</sup>	± 1.0 mm (± 0.04 in) <sup>[3]</sup>	
Maximum Measurement Tolerance <sup>[2]</sup>	± 3.0 mm (± 0.12 in) <sup>[3]</sup>	± 2.0 mm (± 0.08 in) <sup>[3]</sup>	
Range at target plate	50 m / 165 ft	80 m / 260 ft	100 m / 330 ft
Typical Range <sup>[1]</sup>	40 m / 130 ft	80 m / 260 ft	
Range at unfavorable condition <sup>[4]</sup>	35 m / 115 ft	60 m / 200 ft	
Smallest unit displayed	1 mm / 1/16 in	1 mm / 1/32 in	
∅ laser point at distances	6 mm @ 10 m / 30 mm @ 50 m / 60 mm @ 100 m 0.24 in @ 33 ft / 1.2 in @ 164 ft / 2.4 in @ 328 ft		
<b>Tilt measurement</b>			
Measurement tolerance to laser beam <sup>[5]</sup>	no	no	± 0.2 °
Measurement tolerance to case <sup>[5]</sup>	no	no	± 0.2 °
Range	no	no	360 °
Compass accuracy	no	no	8 points (± 22.5 °) <sup>[6]</sup>

	<b>414D</b>	<b>419D</b>	<b>424D</b>
<b>General</b>			
Laser class	2		
Laser type	635 nm, <1 mW		
Protection class	IP40	IP54	
Automatic laser off	90 seconds		
Automatic power off	180 seconds		
Battery life (2 x AAA) 1.5 V NEDA 24A/IEC LR03	up to 3,000 measurements	up to 5,000 measurements	
Dimensions (H x W x L)	11.6 cm x 5.3 cm x 3.3 cm (4.6 in x 2.1 in x 1.3 in)	12.7 x 5.6 x 3.3 cm (5.0 in x 2.2 in x 1.3 in)	
Weight (with batteries)	113 g (4 oz)	153 g (5 oz)	158 g (6 oz)
Temperature range: Storage	-25 °C to +70 °C (-13 °F to +158 °F) 0 °C to +40 °C (32 °F to +104 °F)	-25 °C to +70 °C (-13 °F to +158 °F) -10 °C to +50 °C (14 °F to +122 °F)	
Operation			
Calibration cycle	Not applicable	Not applicable	Tilt and Compass
Maximum altitude	3500 m		

	<b>414D</b>	<b>419D</b>	<b>424D</b>
Maximum relative humidity	85 % at 20 °F to 120 °F (-7 °C to 50 °C)		
Safety	IEC/EN 61010-1:2001 IEC/EN 60825-1:2007 (Class 2)		
EMC	EN 55022:2010 EN 61000-4-3:2010 EN 61000-4-8:2010		
<p>[1] Applies for 100 % target reflectivity (white painted wall), low background illumination, 25 °C.            [2] Applies for 10 to 500 % target reflectivity, high background illumination, -10 °C to +50 °C.            [3] Tolerances apply from 0.05 m to 10 m with a confidence level of 95 %. The maximum tolerance may deteriorate to 0.15 mm/m between 10 m to 30 m and to 0.2 mm/m for distances above 30 m.            [4] Applies for 100 % target reflectivity, background illumination ~ 30,000 lux.            [5] After user calibration. Additional angle related deviation of <math>\pm 0.01^\circ</math> per degree up to <math>\pm 45^\circ</math> in each quadrant. Applies at room temperature. For the whole operating temperature range the maximum deviation increases by <math>\pm 0.1^\circ</math>.            [6] After calibration. Do not use the compass for navigation.</p>			

