



**SMART EC**  
**Earth / Clamp**  
**MI 3123**  
**Instruction manual**  
*Version 1.2, Code no. 20 751 244*

Distributor:

Manufacturer:

METREL d.d.  
Ljubljanska cesta 77  
1354 Horjul  
Slovenia  
web site: <http://www.metrel.si>  
e-mail: [metrel@metrel.si](mailto:metrel@metrel.si)



Mark on your equipment certifies that this equipment meets the requirements of the EU (European Union) concerning safety and electromagnetic compatibility regulations

© 2008 METREL

*The trade names Metrel, Smartec, Eurotest, Autosequence are trademarks registered or pending in Europe and other countries.*

No part of this publication may be reproduced or utilized in any form or by any means without permission in writing from METREL.

<b>1</b>	<b>Preface</b> .....	<b>5</b>
<b>2</b>	<b>Safety and operational considerations</b> .....	<b>6</b>
2.1	Warnings and notes.....	6
2.2	Battery and charging .....	7
2.2.1	New battery cells or cells unused for a longer period.....	8
2.3	Standards applied.....	9
<b>3</b>	<b>Instrument description</b> .....	<b>10</b>
3.1	Front panel .....	10
3.2	Connector panel .....	11
3.3	Back site.....	12
3.4	Display organization .....	13
3.4.1	Battery indication.....	13
3.4.2	Message field .....	13
3.4.3	Result field.....	14
3.4.4	Other messages .....	14
3.4.5	Help screens.....	14
3.4.6	Backlight and contrast adjustments.....	15
3.5	Instrument set and accessories .....	16
3.5.1	Standard set.....	16
3.5.2	Optional accessories .....	16
<b>4</b>	<b>Instrument operation</b> .....	<b>17</b>
4.1	Function selection.....	17
4.2	Settings .....	18
4.2.1	Language.....	18
4.2.2	Initial settings.....	18
4.2.3	Memory.....	19
4.2.4	Date and time .....	20
4.2.5	Length units.....	20
<b>5</b>	<b>Measurements</b> .....	<b>21</b>
5.1	Earth resistance.....	21
5.1.1	(Standard) earth resistance measurement (EARTH 4W).....	22
5.1.2	(Selective) earth resistance measurement with one current clamp.....	23
5.1.3	Contactless earthing resistance measurement (with two current clamps) .....	24
5.1.4	Specific earth resistance measurement .....	25
5.2	Current .....	27
<b>6</b>	<b>Data handling</b> .....	<b>29</b>
6.1	Memory organization .....	29
6.2	Data structure .....	29
6.3	Storing test results.....	30
6.4	Recalling test results .....	30
6.5	Clearing stored data .....	32
6.5.1	Clearing complete memory content.....	32
6.5.2	Clearing measurement(s) in selected location .....	32
6.5.3	Clearing individual measurements .....	33
6.6	Communication.....	34
<b>7</b>	<b>Maintenance</b> .....	<b>35</b>
7.1	Cleaning .....	35
7.2	Periodic calibration .....	35

---

7.3	Service .....	35
<b>8</b>	<b>Technical specifications .....</b>	<b>36</b>
8.1	Earth resistance.....	36
8.2	TRMS Clamp current.....	38
8.3	General data.....	38

# 1 Preface

Congratulations on your purchase of the instrument and its accessories from METREL. The instrument Smartec Earth / Clamp was designed on basis of rich experience, acquired through many years of dealing with earth resistance test equipment.

The hand-held installation tester Smartec Earth / Clamp is intended in general for the following tests and measurements:

- ❑ Earth resistance,
- ❑ Specific earth resistance,
- ❑ Selective earth resistance measurement,
- ❑ Contactless earth resistance measurement,
- ❑ Leakage / TRMS current.

The graphic display with backlight offers easy reading of results, indications, measurement parameters and messages. The operation of the unit is clear and simple – the operator does not need any special training (except reading this instruction manual) to operate the instrument.

In order for operator to be familiar enough with performing measurements in general and their typical applications it is advisable to read Metrel handbook *Guide for testing and verification of low voltage installations*.

The instrument is equipped with all the necessary accessory for comfortable testing.

## 2 Safety and operational considerations

### 2.1 Warnings and notes

In order to reach high level of operator's safety while carrying out various tests and measurements using Smartec Earth / Clamp, as well as to keep the equipment undamaged, it is necessary to consider the following general warnings:

- ❑  **Warning on the instrument means »Read the Instruction manual with special care to safety operation«. The symbol requires an action!**
- ❑ **If the test equipment is used in a manner not specified in this user manual the protection provided by the equipment might be impaired!**
- ❑ **Read this user manual carefully, otherwise use of the instrument may be dangerous for the operator, for the instrument or for the equipment under test!**
- ❑ **Do not use the instrument and accessories if any damage is noticed!**
- ❑ **Service intervention or adjustment and calibration procedure is allowed to be carried out only by a competent authorized person!**
- ❑ **Use only standard or optional test accessories supplied by your distributor!**
- ❑ **Instrument contains rechargeable NiCd or NiMh battery cells. The cells should only be replaced with the same type as defined on the battery placement label or in this manual. Do not use standard alkaline battery cells while power supply adapter is connected, otherwise they may explode!**
- ❑ **Disconnect all test leads, remove the power supply cable and switch off the instrument before removing battery compartment cover.**
- ❑ **All normal safety precautions have to be taken in order to avoid risk of electric shock when working on electrical installations!**
- ❑ **The instrument is intended for using in systems with disconnected mains supply and discharged!**

**General notes related to measurement functions:**

#### General

- ❑ Indicator  means that the selected measurement can't be performed because of irregular conditions on input terminals.
- ❑ PASS / FAIL indication is enabled when parameters are set. Apply appropriate limit value for evaluation of measurement results.
- ❑ Earth resistance measurements shall be performed only on de-energized objects, i.e. voltage between test terminals should be lower than 10 V!

## 2.2 Battery and charging

The instrument uses six AA size alkaline or rechargeable Ni-Cd or Ni-MH battery cells. Nominal operating time is declared for cells with nominal capacity of 2100 mAh.

Battery condition is always displayed in the lower right display part.

In case the battery is too weak the instrument indicates this as shown in figure 2.1. This indication appears for a few seconds and then the instrument turns itself off.

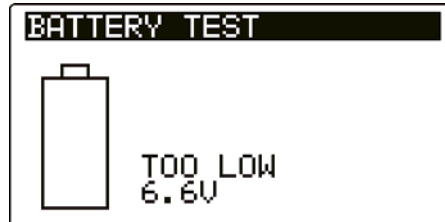

Figure 2.1: Discharged battery indication

The battery is charged whenever the power supply adapter is connected to the instrument. Internal circuit controls charging assuring maximum battery lifetime. The power supply socket polarity is shown in figure 2.2.



Figure 2.2: Power supply socket polarity

The instrument automatically recognizes the connected power supply adapter and begins charging.

Symbols:

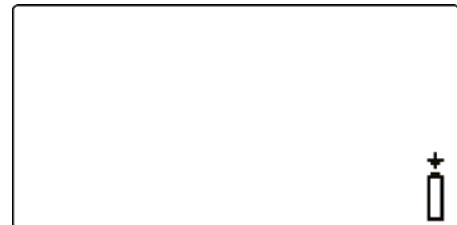
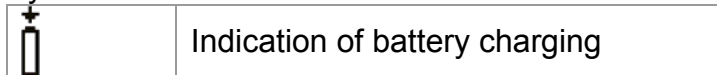

Figure 2.3: Charging indication

- ❑ **⚠ Before opening battery compartment cover disconnect all measuring accessories connected to the instrument and switch off the instrument.**
- ❑ Insert cells correctly, otherwise the instrument will not operate and the batteries could be damaged.
- ❑ Remove all battery cells from the battery compartment if the instrument is not used for a long period of time.
- ❑ **Do not charge alkaline battery cells!**
- ❑ Take into account handling, maintenance and recycling requirements that are defined by related regulations and manufacturers of alkaline or rechargeable batteries!
- ❑ Use only power supply adapter delivered from the manufacturer or distributor of the test equipment to avoid possible fire or electric shock!

## 2.2.1 New battery cells or cells unused for a longer period

Unpredictable chemical processes can occur during charging of new battery cells or cells that were unused for a longer period (more than 3 months). Ni-MH and Ni-Cd battery cells are affected to capacity degradation (sometimes called as memory effect). As a result the instrument operation time can be significantly reduced.

Recommended procedure for recovering battery cells:

Procedure	Notes
➤ Completely <b>charge</b> the battery.	<i>At least 14h with in-built charger.</i>
➤ Completely <b>discharge</b> the battery.	<i>Use the instrument for normal testing until the unit displays the "Bat" symbol on screen.</i>
➤ <b>Repeat</b> the charge / discharge cycle for at least <b>twice</b> .	<i>Four cycles are recommended.</i>

Complete discharge / charge cycle can be performed automatically for each cell using external intelligent battery charger.

### Notes:

- ❑ The charger in the instrument is a pack cell charger. This means that the battery cells are connected in series during the charging. The battery cells have to be equivalent (same charge condition, same type and age).
- ❑ One different battery cell can cause an improper charging and incorrect discharging during normal usage of the entire battery pack (it results in heating of the battery pack, significantly decreased operation time, reversed polarity of defective cell,...).
- ❑ If no improvement is achieved after several charge / discharge cycles, then each battery cell should be checked (by comparing battery voltages, testing them in a cell charger, etc). It is very likely that only some of the battery cells are deteriorated.
- ❑ The effects described above should not be confused with the normal decrease of battery capacity over time. Battery also loses some capacity when it is repeatedly charged / discharged. This information is provided in the technical specification from battery manufacturer.



## 2.3 Standards applied

The MI 3123 Smartec Earth / Clamp instrument is manufactured and tested according to the following regulations, listed below.

### *Electromagnetic compatibility (EMC)*

IEC/ EN 61326-1	Electrical equipment for measurement, control and laboratory use - EMC requirements - Part 1: General requirements Class B (Hand held equipment used in controlled EM environments)
IEC/EN 61326-2-2	Electrical equipment for measurement, control and laboratory use - EMC requirements - Part 2-2: Particular requirements - Test configurations, operational conditions and performance criteria for portable test, measuring and monitoring equipment used in low-voltage distribution systems

### *Safety (LVD)*

IEC/ EN 61010 - 1	Safety requirements for electrical equipment for measurement, control, and laboratory use – Part 1: General requirements
IEC/ EN 61010 - 031	Safety requirements for hand-held probe assemblies for electrical measurement and test

### *Functionality*

IEC/ EN 61557	Electrical safety in low voltage distribution systems up to 1000 V a.c. and 1500 V d.c. - Equipment for testing, measuring or monitoring of protective measures
	Part 1    General requirements
	Part 5    Resistance to earth
	Part 10   Combined measuring equipment

## 3 Instrument description

### 3.1 Front panel

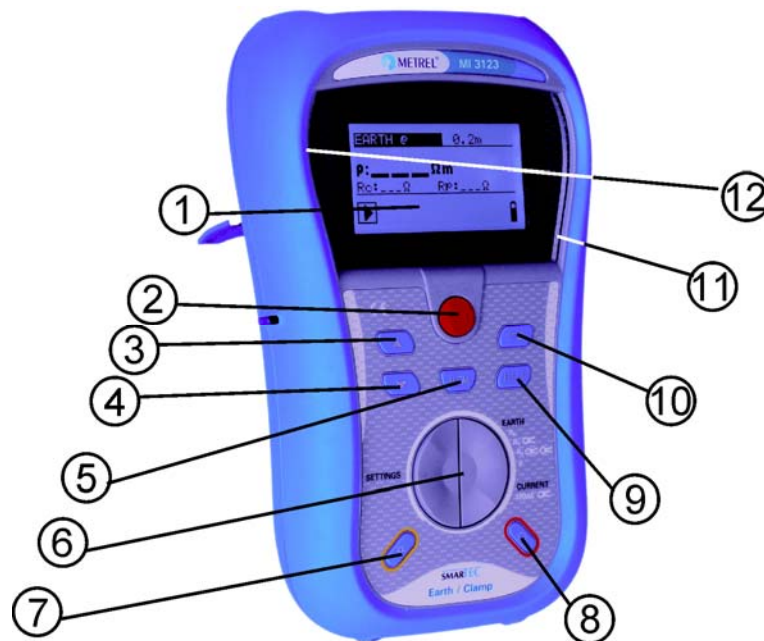

Figure 3.1: Front panel

Legend:

1	LCD	128 x 64 dots matrix display with backlight.
2	TEST	TEST Starts / stops measurements. Accepts selections.
3	UP	Modifies selected parameter.
4	DOWN	
5	MEM	Store / recall / clear tests in memory of instrument.
6	Function selectors	Selects test function.
7	Backlight, Contrast	Changes backlight level and contrast.
8	ON / OFF	Switches the instrument power on or off. <i>The instrument automatically turns off 15 minutes after the last key was pressed.</i>
9	HELP	Accesses help menus.
10	TAB	Selects the parameters in selected function.
11	PASS	Indicate acceptance of result.
12	FAIL	

## 3.2 Connector panel

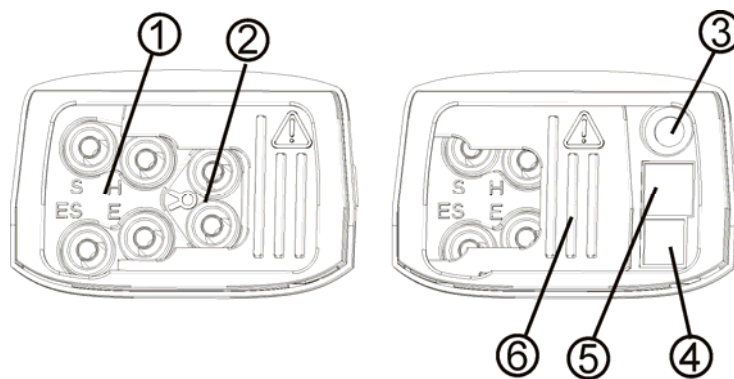

Figure 3.2: Connector panel

Legend:

1	Earth test sockets	Measuring inputs / outputs E, H, S, ES
2	Current clamp sockets	Measuring inputs for current clamp.
3	Charger socket	Connection of power supply adapter.
4	USB connector	Communication with PC USB (1.1) port.
5	PS/2 connector	Communication with PC serial port and connection to optional measuring adapters.
6	Protection cover	Protects from simultaneous access to test connector and power supply adapter socket / communication connectors.

### Warnings!

- ❑ **Maximum allowed voltage between any two test terminals of Earth test sockets is 50 V!**
- ❑ **Do not connect any voltage source on clamp connector sockets! It is intended for connection of current clamp with current output only.**
- ❑ **Maximum short-term voltage of external power supply adapter is 14 V!**
- ❑ **Maximum continuous current in current clamp input is 30 mA!**

### 3.3 Back site

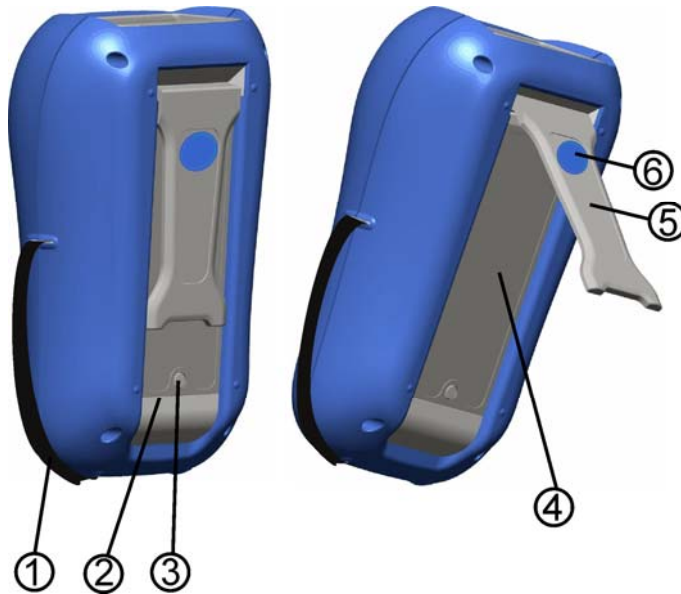

Figure 3.3: Back site

Legend:

- |   |  |
|---|--|
| 1 | Side belt  |
| 2 | Battery compartment cover                                    |
| 3 | Fixing screw for battery compartment cover                   |
| 4 | Back panel information label                                 |
| 5 | Holder for inclined position of the instrument               |
| 6 | Magnet for fixing instrument close to tested item (optional) |

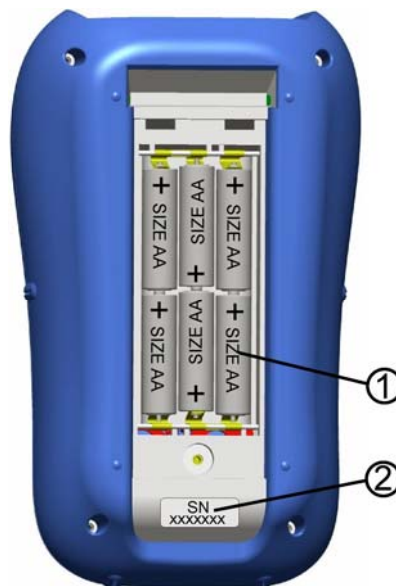

Figure 3.4: Battery compartment

Legend:

- |   |                     |   |
|---|---------------------|---|
| 1 | Battery cells       | Size AA, alkaline or rechargeable NiMH / NiCd |
| 2 | Serial number label |   |

### 3.4 Display organization



Figure 3.5: Typical function display

EARTH RE	Function/ subfunction name
R: 13.82Ω ✓ Rc: 1.9kΩ Rp: 0.0kΩ	Result field
18Ω	Test parameter field
▶	Message field
🔋	Battery indication

#### 3.4.1 Battery indication

The indication indicates the charge condition of battery and connection of external charger.

	Battery capacity indication.
	Low battery. Battery is too weak to guarantee correct result. Replace or recharge the battery cells.
	Recharging in progress (if power supply adapter is connected).

#### 3.4.2 Message field

In the message field warnings and messages are displayed.

	Measurement is running; consider displayed warnings.
	Conditions on the input terminals allow starting the measurement, consider other displayed warnings and messages.
	Result(s) can be stored.
	High electrical noise was detected during measurement. Results may be impaired.
	High resistance to earth of test probes. Results may be impaired.
	Low test current through current clamp in earth resistance measurement. Results may be impaired.

### 3.4.3 Result field



Measurement result is inside pre-set limits (PASS).



Measurement result is out of pre-set limits (FAIL).



Measurement is aborted. Consider displayed warnings and messages.

### 3.4.4 Other messages

**Initial settings**

Instrument settings and measurement parameters/limits are set to initial (factory) values.

### 3.4.5 Help screens

Key:

<b>HELP</b>	Opens help screen.
-------------	--------------------

The help menus contain some basic schematic / connection diagrams to illustrate recommended connection of the instrument to the electrical installation and information about the instrument.

Pressing the **HELP** key in main function menu generates help screen for selected function.

Keys in help menu:

<b>UP / DOWN</b>	Selects next/ previous help screen.
<b>HELP</b>	Scrolls through help screens.
<b>Function selectors / TEST</b>	Exits help menu.

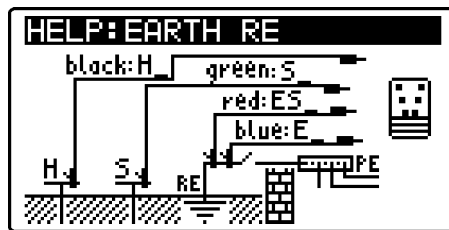

Figure 3.6: Example of help screen

### 3.4.6 Backlight and contrast adjustments

With the **BACKLIGHT** key backlight and contrast can be adjusted.

<b>Click</b>	Toggle backlight intensity level.
Keep pressed for <b>1 s</b>	Lock high intensity backlight level until power is turned off or the key is pressed again.
Keep pressed for <b>2 s</b>	Bargraph for LCD contrast adjustment is displayed.



Figure 3.7: Contrast adjustment menu

Keys for contrast adjustment:

<b>DOWN</b>	Reduces contrast.
<b>UP</b>	Increases contrast.
<b>TEST</b>	Accepts new contrast.
<b>Function selectors</b>	Exits without changes.

## 3.5 Instrument set and accessories

### 3.5.1 Standard set

- Instrument
- Short instruction manual
- Product verification data
- Warranty declaration
- Declaration of conformity
- Test lead 4.5m (blue)
- Test lead 4.5m (red)
- Test lead 20 m (green)
- Test lead 20 m (black)
- Earth rod, 4pcs
- Set of NiMH battery cells
- Power supply adapter
- CD with instruction manual, and *“Guide for testing and verification of low voltage installations”* handbook
- Soft hand strap

### 3.5.2 Optional accessories

See the attached sheet for a list of optional accessories that are available on request from your distributor.



## 4 Instrument operation

### 4.1 Function selection

For selecting test function the **FUNCTION SELECTOR** shall be used.

Keys:

<b>Function selector</b>	Selects test / measurement function: <ul style="list-style-type: none"> <li>□ &lt;<b>EARTH RE, 1 clamp, 2 clamps, <math>\rho</math></b>&gt; measurements of resistance to earth.</li> <li>□ &lt;<b>CURRENT TRMS</b>&gt; TRMS current measurement.</li> <li>□ &lt;<b>SETTINGS</b>&gt; General settings.</li> </ul>
<b>UP/DOWN</b>	Selects sub-function in selected measurement function.
<b>TAB</b>	Selects the test parameter to be set or modified.
<b>TEST</b>	Runs selected test / measurement function.
<b>MEM</b>	Stores measured results / recalls stored results.

Keys in **test parameter** field:

<b>UP/DOWN</b>	Changes the selected parameter.
<b>TAB</b>	Selects the next measuring parameter.
<b>FUNCTION SELECTOR</b>	Toggles between the main functions.
<b>MEM</b>	Stores measured results / recalls stored results.

General rule regarding enabling **parameters** for evaluation of measurement / test result:

Parameter	<b>OFF</b>	No limit values.
	<b>ON</b>	<b>Value(s)</b> – results will be marked as PASS or FAIL in accordance with selected limit.

See *Chapter 5* for more information about the operation of the instrument test functions.

## 4.2 Settings

Different instrument options can be set in the **SETTINGS** menu.

Options are:

- ❑ Selection of language,
- ❑ Setting the instrument to initial values,
- ❑ Recalling and clearing stored results,
- ❑ Setting the date and time,
- ❑ Selection of the length unit.



Figure 4.1: Options in Settings menu

Keys:

<b>UP / DOWN</b>	Selects appropriate option.
<b>TEST</b>	Enters selected option.
<b>Function selectors</b>	Exits back to main function menu.

### 4.2.1 Language

Selecting this option will allow the user to select the instrument language.

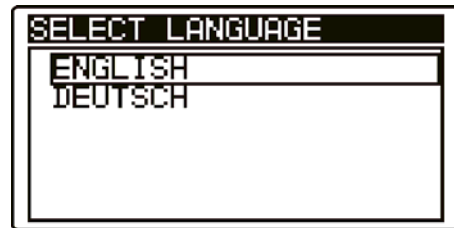

Figure 4.2: Language selection

Keys:

<b>UP / DOWN</b>	Selects language.
<b>TEST</b>	Confirms selected language and exits to settings menu.
<b>Function selectors</b>	Exits back to main function menu.

### 4.2.2 Initial settings

Selecting this option will allow the user to reset the instrument settings and measurement parameters and limits to the manufacturers standard values.

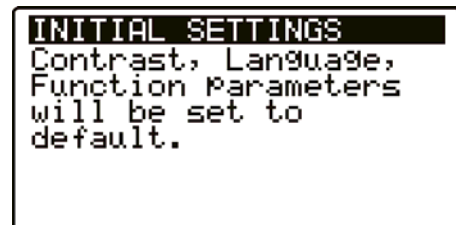

Figure 4.3: Initial settings dialogue

Keys:

<b>TEST</b>	Restores default settings.
<b>Function selectors</b>	Exits back to main function menu without changes.

**Warning:**

- If the batteries are removed for more than 1 minute the custom made settings will be lost.

The default setup is listed below:

Instrument setting	Default value
Contrast	As defined and stored by adjustment procedure
Language	English
Length unit	m

Function Sub-function	Parameters / limit value
EARTH RE	Maximum earth resistance: none selected
EARTH one clamp	Maximum earth resistance: none selected
EARTH two clamps	Maximum earth resistance: none selected
EARTH specific resistance	Distance between test probes: 2 m
CURRENT TRMS	Maximum leakage current: 1 mA

**Note:**

- Initial settings (reset of the instrument) can be recalled also if the TAB key is pressed while the instrument is switched on.

**4.2.3 Memory**

Selecting this option will allow the user to recall, view and delete the stored data. See chapter 6 *Data handling* for more information.



Figure 4.4: Memory options

Keys:

<b>UP / DOWN</b>	Selects option.
<b>TEST</b>	Enters selected option.
<b>Function selectors</b>	Exits back to main function menu.

## 4.2.4 Date and time

Selecting this option will allow the user to set the date and time of the unit.



Figure 4.5: Setting date and time

Keys:

<b>TAB</b>	Selects the field to be changed.
<b>UP / DOWN</b>	Modifies selected field.
<b>TEST</b>	Confirms new setup and exits.
<b>Function selectors</b>	Exits back to main function menu.

**Warning:**

- If the batteries are removed for more than 1 minute the set time and date will be lost.

## 4.2.5 Length units

Selecting this option will allow the user to select the length unit used for the specific earth resistance readings ( $\Omega$ m or  $\Omega$ ft).

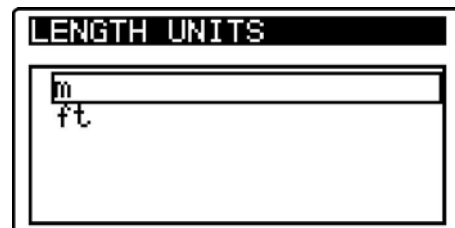

Figure 4.6: Setting length unit

Keys:

<b>UP / DOWN</b>	Selects meters or feet.
<b>TEST</b>	Confirms selected unit.
<b>Function selectors</b>	Exits back to main function menu.

## 5 Measurements

### 5.1 Earth resistance

Earth resistance is one of the most important parameters for protection against electric shock. Main installation earthing arrangements, lightning systems, local earthings, soil resistivity etc can be verified with the Earth tester. All measurements conform to the EN 61557-5 standard.

The Earth resistance main function is divided into four subfunctions:

- **4-wire earth resistance test RE** for standard earth resistance tests with two earthing rods.
- **Selective earth resistance test with one current clamp**, for measuring earth resistance of individual earthing rods.
- **Contactless earth resistance test with two current clamps** (also recommended in IEC 60364-6 for urban areas), for measuring resistance to earth of individual earthing rods.
- **Specific earth resistance**.

See chapter 4.1 *Function selection* for instructions on key functionality.



Figure 5.1: Earth resistance

#### Test parameters for earth resistance measurement

TEST	<b>Test configuration</b> [4-wire RE, one clamp, two clamps, $\rho$ ]
Limit	<b>Maximum resistance</b> [OFF, 1 $\Omega$ ÷ 5 k $\Omega$ , (2 clamps: 1 $\Omega$ ÷ 20 $\Omega$ )]
In $\rho$ subfunction:	
Distance	<b>Distance between probes</b> [0.1 m ÷ 30.0 m] or [1 ft ÷ 100 ft]

#### Earth resistance measurements, common measurement procedure

- Select **EARTH** function using the function selector switch.
- Select **EARTH** subfunction.
- Enable and set **limit** value(optional).
- **Connect** test leads / clamps to the top of the instrument.
- **Connect** the test accessory to the item to be tested (see figures 5.2, 5.3, 5.5, and 5.7).
- Press the **TEST** key to perform the measurement..
- **Store** the result by pressing the MEM key (optional).

5.1.1 (Standard) earth resistance measurement (EARTH RE)

Connections for standard earth resistance measurement

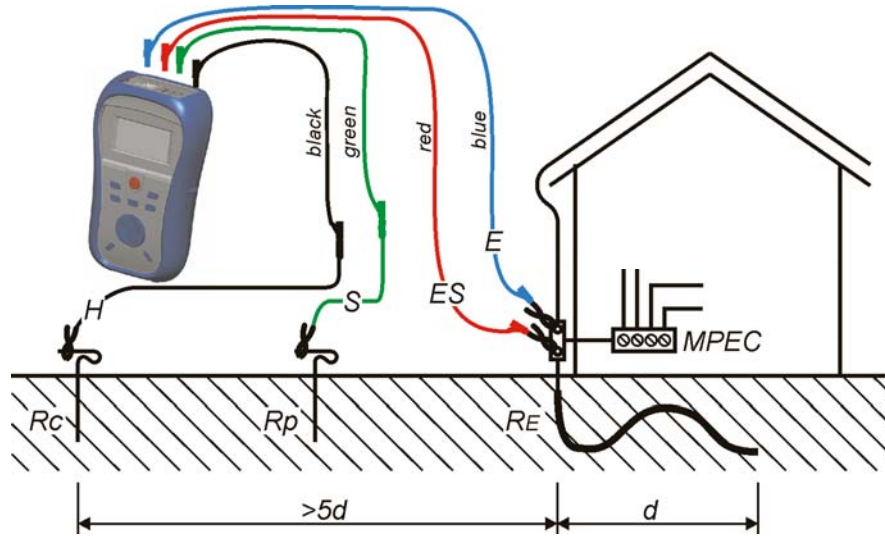

Figure 5.2: Resistance to earth, 4-wire measurement of main installation earthing

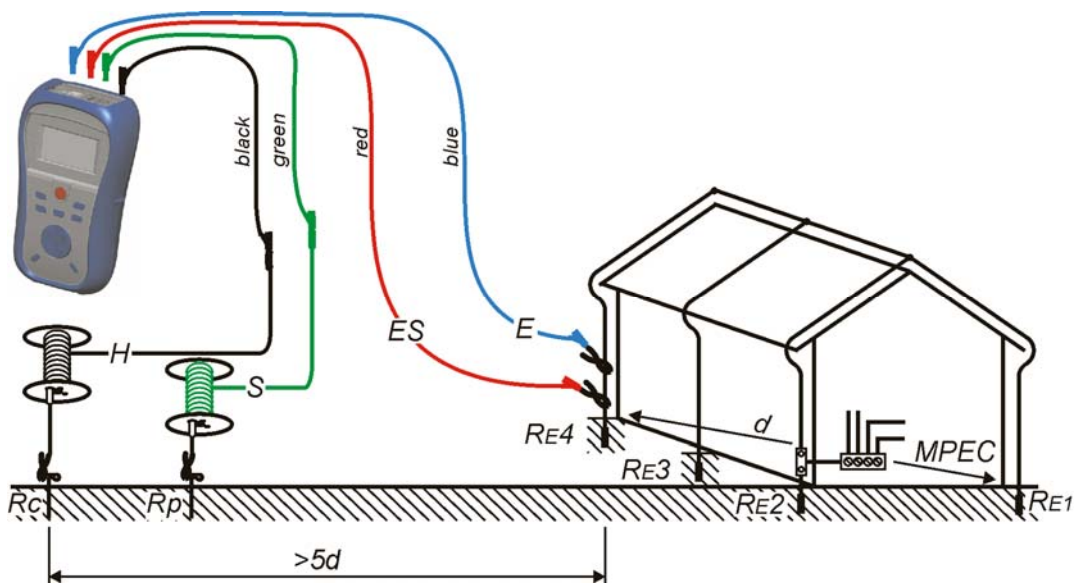

Figure 5.3: Resistance to earth, 4-wire measurement of a lighting protection system



Figure 5.4: Example of earth resistance measurement result

Displayed results for earth resistance measurement:

- R.....Earth resistance,
- Rp.....Resistance of S (potential) probe,
- Rc.....Resistance of H (current) probe.

**Notes:**

- ❑ High resistance of S and H probes could influence the measurement results. In this case, “Rp” and “Rc” warnings are displayed. There is no pass / fail indication in this case.
- ❑ High noise currents and voltages in earth could influence the measurement results. The tester displays the “noise” warning in this case.
- ❑ Probes must be placed at sufficient distance from the measured object.

**5.1.2 (Selective) earth resistance measurement with one current clamp**

This measurement enables testing (selective) earth resistance of individual earthing rods in earthing systems.

**Connection for selective earth resistance measurement**

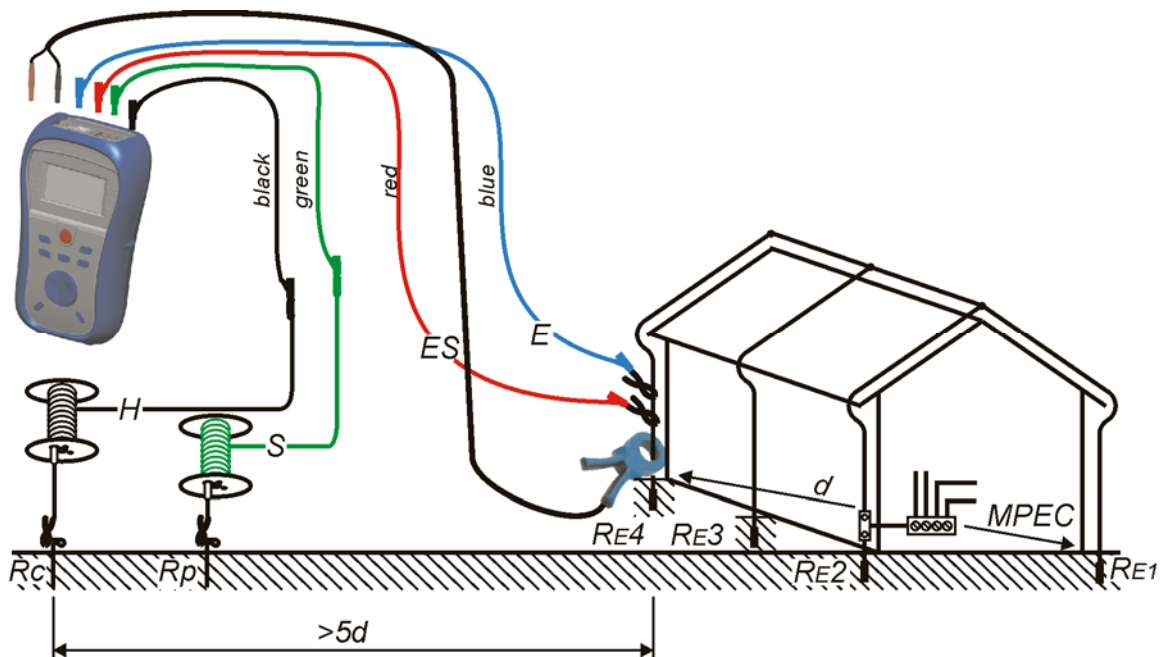

Figure 5.5: Selective earth resistance measurement



Figure 5.6: Example of selective earth resistance measurement results

Displayed results for selective earth resistance measurement:

- R.....Earth resistance of measured earthing rod,
- Rp.....Sum of resistances of potential measuring probes (S plus ES),
- Rc.....Sum of resistances of current carrying probes (H plus E).

**Notes:**

- ❑ Connect test clamp between E test terminal and ground, otherwise the parallel resistance of all electrodes (RE1 up to RE3) will be measured.

- ❑ High quality leakage current clamp (eg. METREL A1018) shall be used.
- ❑ In large systems the measured partial current is only a small portion of the test current through the current clamp. The measuring accuracy for small currents of and immunity against noise currents must be considered. The tester displays the “low current” warning in this case.
- ❑ High resistance of S and H probes could influence the measurement results. In this case, “Rp” and “Rc” warnings are displayed. There is no pass / fail indication in this case.
- ❑ High noise currents and voltages in earth could influence the measurement results. The tester displays the “noise” warning in this case.
- ❑ Probes must be placed at sufficient distance from the measured object.

### 5.1.3 Contactless earthing resistance measurement (with two current clamps)

The measurement enables simple testing of individual earthing rods in large earthing system. It is especially suitable for use in urban areas because there is usually no possibility to place the test probes.

#### Connection for contactless earthing resistance measurement

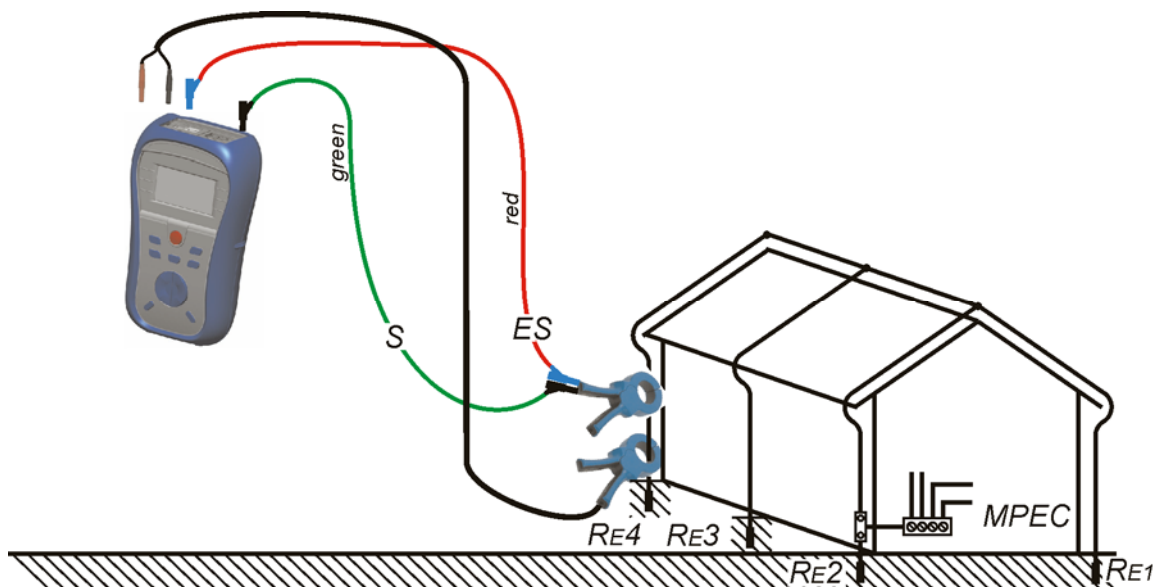

Figure 5.7: Contactless earthing resistance measurement



Figure 5.8: Example of contactless earthing resistance measurement result

Displayed results for contactless earthing resistance measurement:  
R.....Earthing resistance.

#### Notes:

- ❑ The distance between clamps should be at least 30 cm.



- ❑ High noise currents and voltages in earth could influence the measurement results. The tester displays the “noise” warning in this case.
- ❑ The measurement results are very accurate for resistances below  $10\ \Omega$ . At higher values (several  $10\ \Omega$ ) the test current drops to few mA. The measuring accuracy for small currents and immunity against noise currents must be considered! The tester displays the “low current” warning in this case.

### 5.1.4 Specific earth resistance measurement

The specific earth resistance (soil resistivity) is measured to determine the characteristic of the soil. The results are used to properly dimension earthing systems (size, depth, number and position of earthing rods).

#### Circuit for specific earth resistance measurement

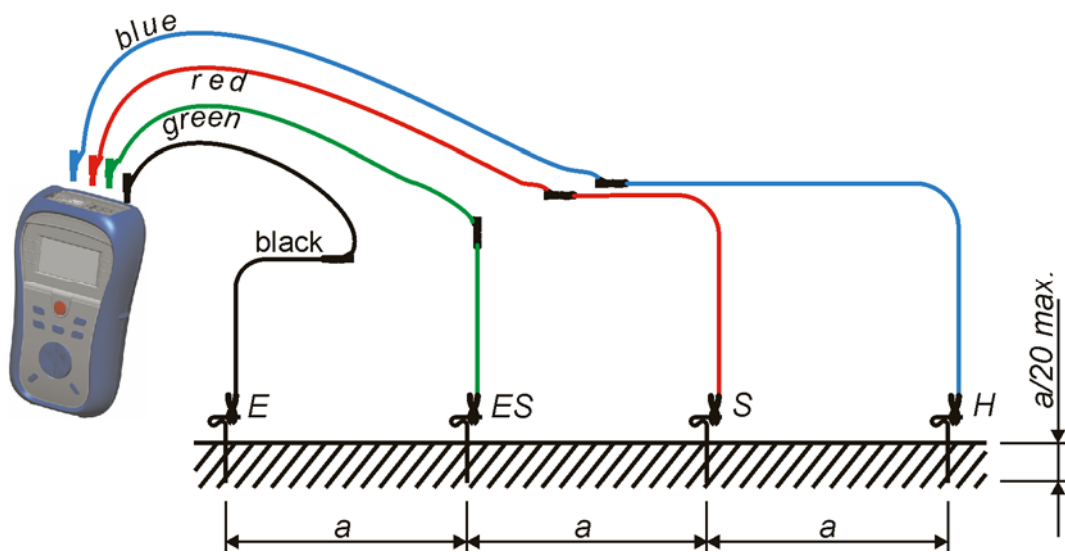

Figure 5.9: Specific earth resistance measurement

#### Specific earth resistance measurement procedure

- ❑ Select **EARTH** function using the function selector switch.
- ❑ Select  **$\rho$**  subfunction.
- ❑ Select the **distance** (a) between test probes.
- ❑ **Connect** test leads to the top of the instrument.
- ❑ **Connect** the test accessory to the item to be tested (see figure 5.9).
- ❑ Press the **TEST** key to perform the measurement.
- ❑ **Store** the result by pressing the MEM key (optional).



Figure 5.10: Example of specific earth resistance measurement result

Displayed results for earth resistance measurement:

- ρ.....Specific earth resistance.
- Rc.....Resistance of H,E (current) probes,
- Rp.....Resistance of S;ES (potential probe).

- High resistance of S, H, ES, E probes could influence the measurement results. In this case, “Rp” and “Rc” warnings are displayed. There is no pass / fail indication in this case.
- High noise currents and voltages in earthing could influence the measurement results. The tester displays the “noise” warning in this case.

## 5.2 Current

This function is intended for measurement of AC currents with current clamp (leakage currents, loads currents, noise currents).

See chapter 4.1 *Function selection* for instructions on key functionality.

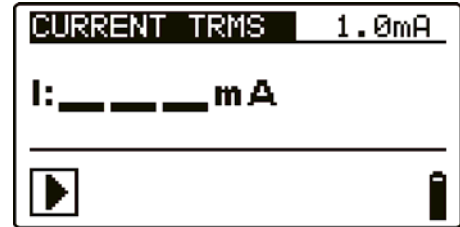

Figure 5.11: Current

### Test parameter for current measurement with clamp

Limit	Maximum current [OFF, 0.1 mA ÷ 100 mA]
-------	--

### Connections for current measurements

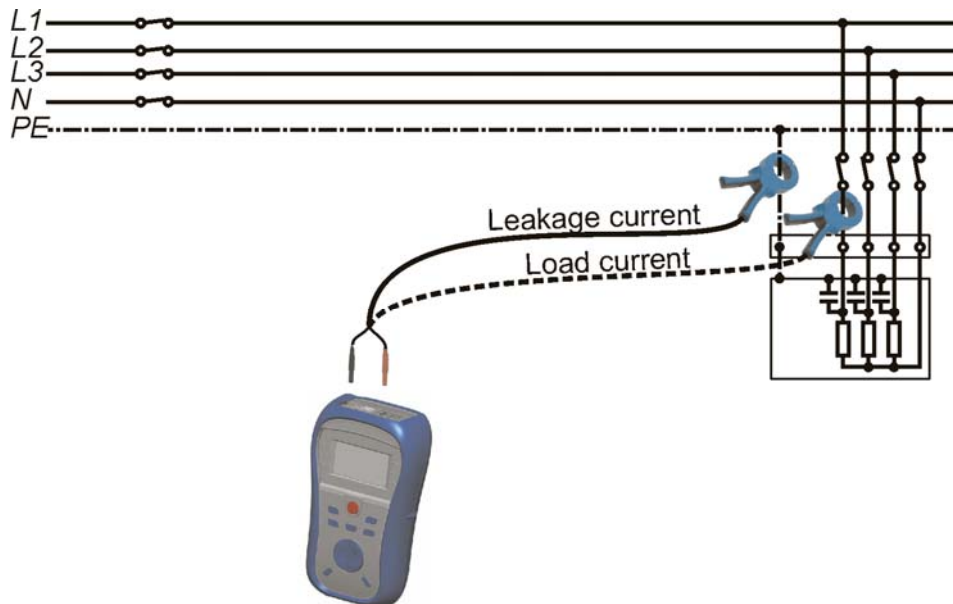

Figure 5.12: Leakage and load current measurements

**Current measuring procedure**

- ❑ Select the **CURRENT** function using the function selector switch.
- ❑ Enable and set **limit** value (optional).
- ❑ **Connect** current clamp to the top of the instrument.
- ❑ Embrace the tested conductor with current clamp (see figure 5.12).
- ❑ Press the **TEST** key to start the measurement.
- ❑ Press the **TEST** key again to finish the measurement.
- ❑ **Store** the result by pressing the MEM key (optional).

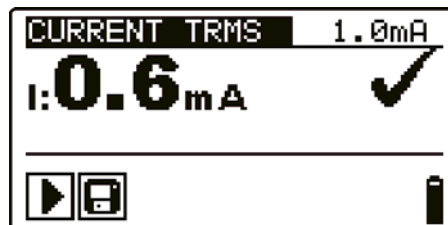

Figure 5.13: Example of clamp current measurement result

Displayed result:  
I.....Current.

**Note:**

- ❑ To obtain correct readings the current clamp ration should be 1000:1.
- ❑ The METREL current clamps A1018 are best suited for use with the instrument (current output, ratio 1000:1, appropriate accuracy for leakage and load currents).

## 6 Data handling

### 6.1 Memory organization

Measurement results together with all relevant parameters can be stored in the instrument's memory.

### 6.2 Data structure

The instrument's memory place is divided into 3 levels each containing 199 locations each. The number of measurements that can be stored into one location is not limited.

The **data structure field** describes the identity of the measurement (which object, earthing system, earthing element).

The **measurement field** contains information about type and number of measurements that belong to the selected structure element (object and system and element).

This organization helps to handle with data in a simple and effective manner.

The main advantages of this system are:

- ❑ Test results can be organized and grouped in a structured manner that reflects the structure of typical earthing systems.
- ❑ Simple browsing through structures and results.
- ❑ Test reports can be created with no or little modifications after downloading results to a PC.

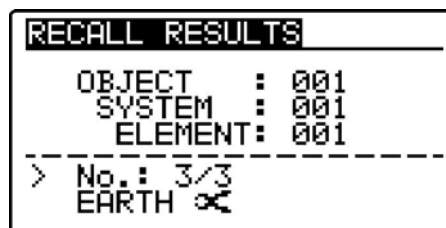

Figure 6.1: Data structure and measurement fields

#### Data structure field

<b>RECALL RESULTS</b>	Memory operation menu
OBJECT : 001 SYSTEM : 001 ELEMENT: 001	Data structure field
OBJECT: 001	Root level in the structure: <ul style="list-style-type: none"> <li>❑ <b>OBJECT</b>: 1<sup>st</sup> level location name.</li> <li>❑ <b>001</b>: No. of selected object.</li> </ul>
SYSTEM : 001	Sub-level (level 2) in the structure: <ul style="list-style-type: none"> <li>❑ <b>SYSTEM</b>: 2<sup>nd</sup> level location name.</li> <li>❑ <b>001</b>: No. of selected system.</li> </ul>
ELEMENT: 001	Sub-level (level 3) in the structure: <ul style="list-style-type: none"> <li>❑ <b>ELEMENT</b>: 3<sup>rd</sup> level location name.</li> <li>❑ <b>001</b>: No. of selected element.</li> </ul>

#### Measurement field

EARTH ⌘	Type of stored measurement in the selected location.
No. : 3/3	No. of selected test result / No. of all stored test results in selected location.

### 6.3 Storing test results

After the completion of a test the results and parameters are ready for storing (💾 icon is displayed in the information field). By pressing the **MEM** key, the user can store the results.

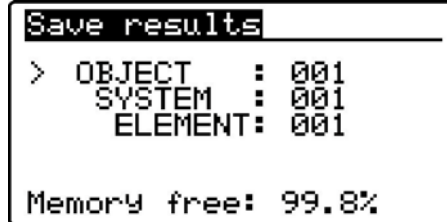

Figure 6.2: Save test menu

Memory free: 99.6% Memory available for storing results.

Keys in save test menu - data structure field:

<b>TAB</b>	Selects the location element (Object / System / Element).
<b>UP / DOWN</b>	Selects number of selected location element (1 to 199).
<b>MEM</b>	Saves test results to the selected location and returns to the measuring menu.
<b>Function selectors / TEST</b>	Exits back to main function menu.

**Notes:**

- ❑ The instrument offers to store the result to the last selected location by default.
- ❑ If the measurement is to be stored to the same location as the previous one just press the **MEM** key twice.

### 6.4 Recalling test results

Press the **MEM** key in a main function menu when there is no result available for storing or select **MEMORY** in the **SETTINGS** menu.

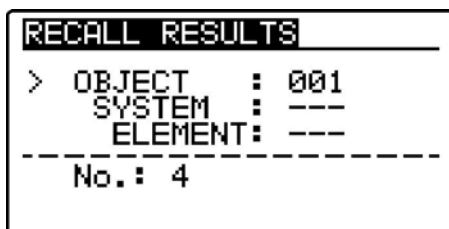

Figure 6.3: Recall menu - data structure field selected

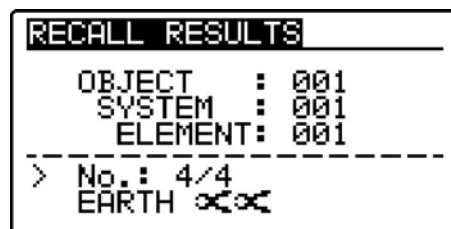

Figure 6.4: Recall menu - measurements field selected

Keys in recall memory menu (data structure field selected):

<b>TAB</b>	Selects the location element (Object / System / Element) Enters measurements field.
<b>UP / DOWN</b>	Selects number of selected location element (1 to 199).
<b>Function selectors / TEST</b>	Exits back to main function menu.

Keys in recall memory menu (measurements field selected):

<b>UP / DOWN</b>	Selects the stored measurement.
<b>MEM</b>	Displays measurement results.
<b>Function selectors / TEST</b>	Exits back to main function menu.

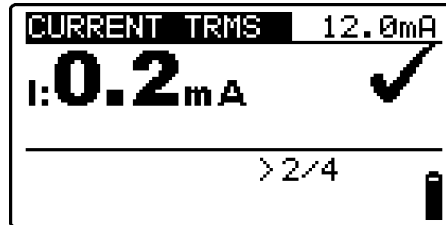

Figure 6.5: Example of recalled measurement result

Keys in recall memory menu (measurement results are displayed)

<b>UP / DOWN</b>	Displays measurement results stored in selected location
<b>MEM, TEST</b>	Returns to main MEM menu.
<b>Function selectors /</b>	Exits back to main function menu.

## 6.5 Clearing stored data

### 6.5.1 Clearing complete memory content

Select **CLEAR ALL MEMORY** in **MEMORY** menu. A warning (see fig. 6.6) will be displayed.

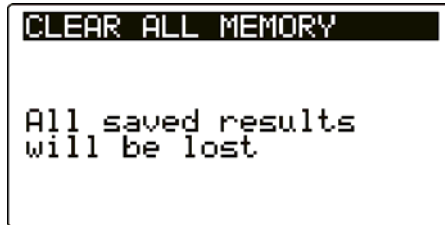

Figure 6.6: Clear all memory

Keys in clear all memory menu

<b>TEST</b>	Confirms clearing of complete memory content.
<b>Function selectors</b>	Exits back to main function menu without changes.

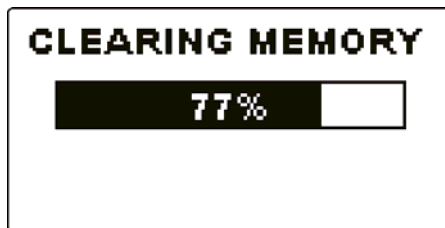

Figure 6.7: Clearing memory in progress

### 6.5.2 Clearing measurement(s) in selected location

Select **DELETE RESULTS** in **MEMORY** menu.

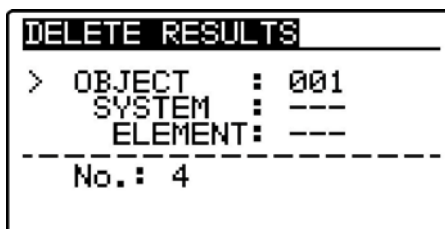

Figure 6.8: Clear measurements menu (data structure field selected)

Keys in delete results menu (data structure field selected):

<b>TAB</b>	Selects location element (Object / System / Element). Enters measurements field.
<b>UP / DOWN</b>	Selects number of selected location element (1 to 199).
<b>Function selectors / MEM</b>	Exits back to main function menu.
<b>TEST</b>	Opens dialog for confirmation to clear result in selected location.



Keys in dialog for confirmation to clear results in selected location:

<b>TEST</b>	Deletes all results in selected location.
<b>MEM</b>	Exits back to delete results menu without changes.
<b>Function selectors</b>	Exits back to main function menu without changes.

### 6.5.3 Clearing individual measurements

Select **DELETE RESULTS** in **MEMORY** menu.

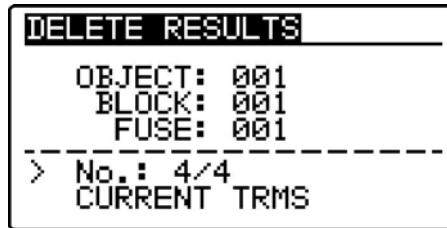

Figure 6.9: Clear measurements menu (data structure field selected)

Keys in delete results menu (measurements field selected)

<b>TAB</b>	Returns to data structure field.
<b>UP / DOWN</b>	Selects measurement.
<b>TEST</b>	Opens dialog for confirmation to clear selected measurement.
<b>Function selectors / MEM</b>	Exits back to main function menu without changes.

Keys in dialog for confirmation to clear selected result(s):

<b>TEST</b>	Deletes selected measurement result.
<b>MEM</b>	Exits back to delete results menu – measurements field without changes.
<b>Function selectors</b>	Exits back to main function menu.

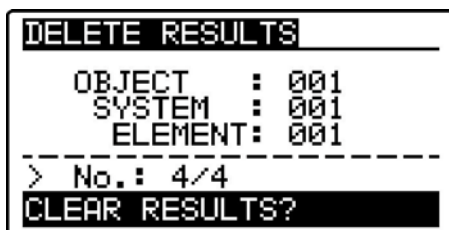

Figure 6.10: Dialog for confirmation

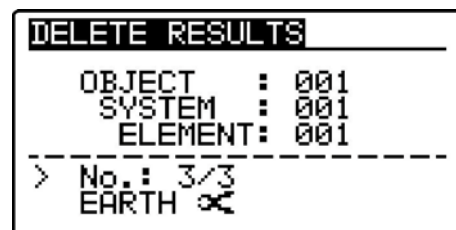

Figure 6.11: Display after measurement was cleared

## 6.6 Communication

Stored results can be transferred to a PC. A special communication program on the PC automatically identifies the instrument and enables data transfer between the instrument and the PC.

There are two communication interfaces available on the instrument: USB or RS 232.

The instrument automatically selects the communication mode according to detected interface. USB interface has priority.

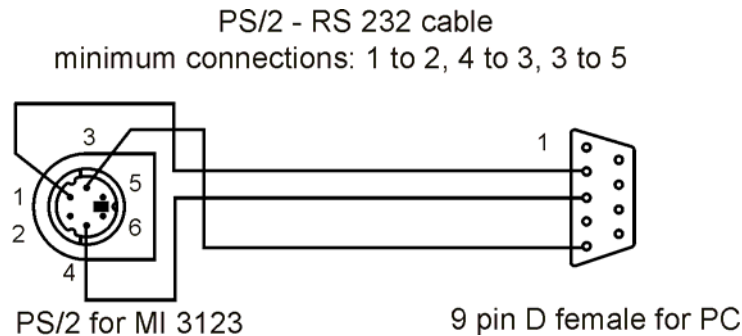

Figure 6.12: Interface connection for data transfer over PC COM port

How to transfer stored data:

- ❑ RS 232 communication: connect a PC COM port to the instrument PS/2 connector using the PS/2 - RS232 serial communication cable;
- ❑ USB communication selected: connect a PC USB port to the instrument USB connector using the USB interface cable.
- ❑ Switch **on** the PC and the instrument.
- ❑ **Run** the *EuroLink* program.
- ❑ The PC and the instrument will automatically recognize each other.
- ❑ The instrument is prepared to download data to the PC.

The program *EuroLink* is a PC software running on Windows 95/98, Windows NT, Windows 2000, Windows XP, Windows Vista. Read the file README\_EuroLink.txt on CD for instructions about installing and running the program.

**Note:**

- ❑ USB drivers should be installed on PC before using the USB interface. Refer to USB installation instructions available on installation CD.

## **7 Maintenance**

Unauthorized persons are not allowed to open the Smartec Earth / Clamp instrument. There are no user replaceable components inside the instrument, except the battery under rear cover.

### **7.1 Cleaning**

No special maintenance is required for the housing. To clean the surface of the instrument use a soft cloth slightly moistened with soapy water or alcohol. Then leave the instrument to dry totally before use.

#### **Warnings:**

- ❑ Do not use liquids based on petrol or hydrocarbons!
- ❑ Do not spill cleaning liquid over the instrument!

### **7.2 Periodic calibration**

It is essential that the test instrument is regularly calibrated in order that the technical specification listed in this manual is guaranteed. We recommend an annual calibration. Only an authorized technical person can do the calibration. Please contact your dealer for further information.

### **7.3 Service**

For repairs under warranty, or at any other time, please contact your distributor.

## 8 Technical specifications

### 8.1 Earth resistance

#### Earth resistance 4-wire method (EARTH RE)

Measuring range according to EN61557 is  $0.67 \Omega \div 9999 \Omega$

Measuring range R ( $\Omega$ )	Resolution ( $\Omega$ )	Accuracy
0.00 $\div$ 19.99	0.01	$\pm(3 \% \text{ of reading} + 3 \text{ digits})$
20.0 $\div$ 199.9	0.1	
200 $\div$ 1999	1	$\pm 5 \% \text{ of reading}$
2000 $\div$ 9999	1	$\pm 10 \% \text{ of reading}$

Additional spike resistance error if

Rc max. or Rp max. is exceeded .....  $\pm(5 \% \text{ of reading} + 10 \text{ digits})$

Rc max. .... (4 k $\Omega$  + 100 R) or 50 k $\Omega$  (whichever is lower)

Rp max. .... (4 k $\Omega$  + 100 R) or 50 k $\Omega$  (whichever is lower)

Automatic test of probe resistance..... yes

Additional error

at 3 V noise (50 Hz) .....  $\pm(5 \% \text{ of reading} + 10 \text{ digits})$

Automatic test of voltage noise ..... yes

Open-terminal test voltage..... 40 V<sub>AC</sub>

Test voltage frequency..... 125 Hz

Short-circuit test current..... < 20 mA

#### Earth resistance one clamp method

Measuring range R ( $\Omega$ )	Resolution ( $\Omega$ )	Accuracy
0.00 $\div$ 19.99	0.01	$\pm(3 \% \text{ of reading} + 3 \text{ digits})$
20.0 $\div$ 199.9	0.1	
200 $\div$ 1999	1	$\pm 5 \% \text{ of reading}$
2000 $\div$ 9999	1	$\pm 10 \% \text{ of reading}$

Additional spike resistance error if

Rc max. or Rp max. is exceeded .....  $\pm(5 \% \text{ of reading} + 10 \text{ digits})$

Rc max. .... (4 k $\Omega$  + 100 R) or 50 k $\Omega$  (whichever is lower)

Rp max. .... (4 k $\Omega$  + 100 R) or 50 k $\Omega$  (whichever is lower)

Automatic test of probe resistance..... yes

Resistance ratio induced error ..... 2 % x R/Re\*

Additional error

At 3 V noise (50 Hz) .....  $\pm(5 \% \text{ of reading} + 10 \text{ digits})$

$\leq 2$  A noise (50 Hz) .....  $\pm(10 \% \text{ of reading} + 10 \text{ digits})$

Automatic test of voltage noise ..... yes

Noise voltage indication threshold .... 1 V (<50  $\Omega$ , worst case)

Open-terminal test voltage..... 40 V<sub>AC</sub>

Test voltage frequency..... 125 Hz

Short-circuit test current..... <20 mA

Low clamp current indication ..... yes

Noise current indication ..... yes

Additional clamp error has to be considered.

\* Re is resistance to earth of complete grounding system

### Earth resistance two clamps method

Measuring range ( $\Omega$ )	Resolution ( $\Omega$ )	Accuracy*
0.00 ÷ 19.9	0.01	± (10 % of reading + 10 digits)
20.0 ÷ 30.0	0.1	± (20 % of reading )
30.1 ÷ 99.9	0.1	±( 30 % of reading )

\* Distance between test clamps >30 cm.

Additional error

at 3 A / 50 Hz noise into 1  $\Omega$  ..... ±(10 % of reading)

Test voltage frequency..... 125 Hz

Noise current indication ..... yes

Low clamp current indication ..... yes

Additional clamp error has to be considered.

### Specific earth resistance

Measuring range ( $\Omega$ m)	Resolution ( $\Omega$ m)	Accuracy
0.0 ÷ 99.9	0.1	Calculated value, consider earth resistance 4-wire method
100 ÷ 999	1	
1.00k ÷ 9.99k	0.01k	
10.0k ÷ 99.9k	0.1k	
>100k	1k	

Measuring range ( $\Omega$ ft)	Resolution ( $\Omega$ ft)	Accuracy
0.0 ÷ 99.9	0.1	Calculated value, consider earth resistance 4-wire method
100 ÷ 999	1	
1.00k ÷ 9.99k	0.01k	
10.0k ÷ 99.9k	0.1k	
>100k	1k	

Wenner method principle with equal distances between test probes:

$$\rho = 2 \cdot \pi \cdot \text{distance} \cdot R,$$

with R as measured resistance in 4-wire method.

Additional error

See Earth resistance 4-wire method.

## 8.2 TRMS Clamp current

Measuring range	Resolution	Accuracy
0.0 mA ÷ 99.9 mA	0.1 mA	±(3 % of reading + 3 digits)
100 mA ÷ 999 mA	1 mA	
1.00 A ÷ 19.99 A	0.01 A	

Input resistance ..... 100 Ω  
 Maximum input current ..... 30 mA (=30 A @ current clamp with ratio 1000:1)  
 Measurement principle..... current clamp, ratio 1000:1  
 Nominal frequency..... 40 Hz ÷ 500 Hz  
 Additional clamp error has to be considered.

## 8.3 General data

Power supply voltage..... 9 V<sub>DC</sub> (6×1.5 V battery or accumulator, size AA)  
 Operation..... typical 20 h  
 Charger socket input voltage ..... 12 V ± 10 %  
 Charger socket input current..... 400 mA max.  
 Battery charging current..... 250 mA (internally regulated)  
 Overvoltage category..... 50 V CAT IV  
 Protection classification ..... double insulation  
 Pollution degree..... 2  
 Protection degree ..... IP 40

Display ..... 128x64 dots matrix display with backlight

Dimensions (w × h × d) ..... 14 cm × 8 cm × 23 cm  
 Weight ..... xx kg, without battery cells

### Reference conditions

Reference temperature range..... 10 °C ÷ 30 °C  
 Reference humidity range..... 40 %RH ÷ 70 %RH

### Operation conditions

Working temperature range ..... 0 °C ÷ 40 °C  
 Maximum relative humidity ..... 95 %RH (0 °C ÷ 40 °C), non-condensing

### Storage conditions

Temperature range..... -10 °C ÷ +70 °C  
 Maximum relative humidity ..... 90 %RH (-10 °C ÷ +40 °C)  
 80 %RH (40 °C ÷ 60 °C)

### Communication transfer speed

RS 232..... 115200 baud  
 USB ..... 256000 baud

The error in operating conditions could be at most the error for reference conditions (specified in the manual for each function) +1 % of measured value + 1 digit, unless otherwise specified in the manual for particular function.

## A Appendix A - Accessories for specific measurements

The table below presents standard and optional accessories required for specific measurement. The accessories marked as optional may also be standard ones in some sets. Please see attached list of standard accessories for your set or contact your distributor for further information.

Function	Suitable accessories (Optional with ordering code A...., S....)
Earth resistance, RE	<input type="checkbox"/> Earth set 20 m, 4-wire <input type="checkbox"/> Earth set 50 m, 4-wire (S 2041)
Earth resistance, 1 clamp	<input type="checkbox"/> Earth set 20 m, 4-wire <input type="checkbox"/> Earth set 50 m, 4-wire (S 2041) <input type="checkbox"/> Low range current clamp (A1018)
Earth resistance, 2 clamps	<input type="checkbox"/> Test lead set 2 m (S2009) <input type="checkbox"/> Low range current clamp (A1018) <input type="checkbox"/> Standard current clamp (A1019)
Specific earth resistance	<input type="checkbox"/> Earth set 20 m, 4-wire <input type="checkbox"/> Earth set 50 m, 4-wire (S 2041)
Current	<input type="checkbox"/> Test lead set 2 m (A1278) <input type="checkbox"/> Low range current clamp (A1018) <input type="checkbox"/> Standard current clamp (A1019)

