

**FLUKE**

# i2000flex

## 2000A Flexible AC Current Probe

### Instruction Sheet

#### Introducing the i2000flex

The i2000flex is a flexible AC current probe for use with oscilloscopes and multimeters. The supplied Dual Banana to BNC Adapter can be used for connection to instruments with banana inputs. The i2000flex is optimized for current measurement on thick and hard to reach conductors.

#### Unpacking

The following items should be included in the package:

- i2000flex Current Probe
- Dual Banana to BNC Adapter (model PM9081/001)
- Instruction Sheet (this paper)

Check the contents of the shipping box for completeness. If something in the box has been damaged or missing, contact your distributor or the nearest FLUKE sales or service office immediately.

#### Safety Information



**Read First: Safety Information**

To ensure safe operation and service of the current clamp, follow these instructions:

- Read the operating instructions before use and follow all safety instructions.
- Use the Current Probe only as specified in the operating instructions; otherwise the probe's safety features may not protect you.
- Adhere to local and national safety codes. Individual protective equipment must be used to prevent shock and arc blast injury where hazardous live conductors are exposed.
- Before each use, inspect the Current Probe and its latching system for any damage. Pay particular attention to the insulation surrounding the flexible measuring head. Look for cracks or missing portions of the probe housing or output cable insulation. Also look for loose or weakened components.
- Do not use a probe that is cracked, damaged, or has a defective cable.
- Never use the probe on a circuit with voltages higher than 600 V CAT III.
  - CAT III equipment is designed to protect against transients in equipment in fixed equipment installations, such as distribution panels, feeders and short branch circuits, and lighting systems in large buildings.
- De-energize the installation on which current will be measured or adopt safe operating procedures during application and removal of the current probe.
- Use extreme caution when working around bare conductors or bus bars.

- Do not use the Current Probe to measure bare conductors carrying a voltage from 30V up to 600V unless you are wearing protective clothing suitable for high-voltage work. Contact with the conductor could result in electric shock. Always use appropriate equipment for personal protection.
- Use caution when working with voltages above 60 V dc, 30 V ac rms or 42 V ac peak. Such voltages pose a shock hazard.
- Do not expose the i2000flex unit to water.

#### Symbols

	Do not apply around or remove from HAZARDOUS LIVE conductors.
	Product is protected by double insulation.
	Risk of Danger. Important information. See Instruction Sheet.
	Risk of Electric Shock.
	Conforms to relevant European standards.
	Earth ground.

#### Specifications

##### SAFETY



i2000flex (INPUT and OUTPUT)

Complies with American industry standards UL61010B-1 & UL61010B-2-032 & European standards EN/IEC 61010-1 2nd Edition & EN/IEC 61010-02-032.

##### EMC

Complies with: EN/IEC 50081-1 EN/IEC 50082-2

##### ELECTRICAL SPECIFICATIONS

All Electrical Specifications are valid at the following reference conditions:

- Ambient temperature 23±3°C (73±5.4°F)
- Relative Humidity 0 to 85%
- Frequency 48 to 65 Hz
- Continuous external field < 40 A/m
- Load impedance on BNC output > 1 kΩ // < 100 pF
- The current may not contain any DC component
- No influence from adjacent currents
- Conductor centered within the probe aperture
- "POWER ON" indicator flashing (green LED)
- "BATTERY LOW" indicator not flashing (red LED) (see Figure 1)

	Current Ranges	
	200A	2000A
Measuring range	2 to 200A ac	20 to 2000 A ac
Crest factor *	up to 1.6	up to 1.6
Maximum non-destructive current:	100 kA	100 kA
Output signal	10 mV/A	1 mV/A
Basic accuracy	±1% of full scale	±1% of full scale
Noise	< 2 mV rms (200 mA rms)	< 2 mV rms (2A rms)
Additional errors:		
• with temperature (0 to +70 °C, 32 to 158 °F)	0.02% of reading /°C, 0.036% of reading /°F	0.02% of reading /°C, 0.036% of reading /°F
• with position of conductor in the probe window	±2% of full scale (bus ≥ 2.5 cm or 1 inch from coupling)	±2% of full scale (bus ≥ 2.5 cm or 1 inch from coupling)
• with external fields (<40 A/m)	±1% of full scale (adjacent conductor ≥ 20 cm or 8 inch from head.)	±1% of full scale (adjacent conductor ≥ 20 cm or 8 inch from head.)
Phase shift 50 to 60 Hz	See Figure 2 < ±0.5°	See Figure 3 < ±0.5°

\* This is the maximum permissible ratio between the peak value of a superimposed transient and the ac rms value.

Bandwidth (-3dB)	1 Hz to 20 kHz
Battery	9V alkaline IEC 6LR61, 550 mAh
Battery life	> 100 hr
Battery Indicators (see Figure 1)	
Power On	Green LED flashing
Battery Low	Red LED flashing

##### GENERAL

Coupling diameter	∅ 22.2 mm (0.874 in)
Weight	420 g (14.8 oz)
Transducer length	60 cm (31.5 in)
Transducer diameter	14.3 mm (0.563 in)
Minimum bending radius	38 mm (1.5 in)
Cable length from transducer to box	1.8 m (71 in)
Cable length from box to BNC output	0.5 m (19.7 in)
Maximum extension cable length	15 m (50 ft)
Weight (without battery)	420 gr (14.8 oz)
Temperature operating:	
Transducer	-20 to +90°C (-4 to +194°F)
i2000flex unit	0 to +70°C (32 to +158°F)
Temperature non-operating:	
Transducer and i2000flex unit	-40 to +105°C (-40 to +221°F)
Relative Humidity	
Operating	0 to 85%, < +35°C (+95°F)
Non-operating	0 to 75%, < +90°C (+194°F)
	0 to 85%, < -10°C (+14°F)
	0 to 75%, < +105°C (+221°F)
Altitude	
Operating	to 3000 m (10000 ft)
Non-operating	to 12000 m (40000 ft)

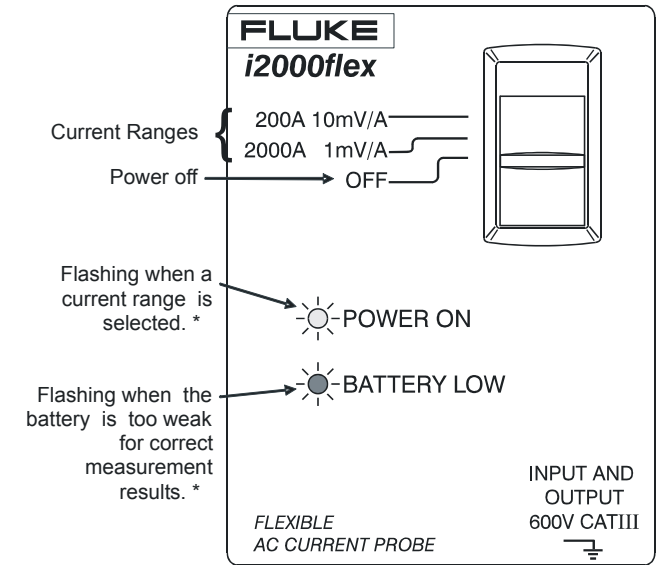

Figure 1. Text on the i2000flex unit

\* Note: When the battery is almost empty, none of the LEDs will flash.

#### PHASE SHIFT

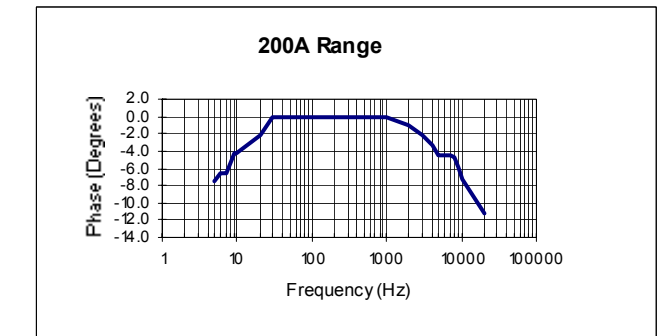

Figure 2. Phase Shift versus Frequency (200A range)

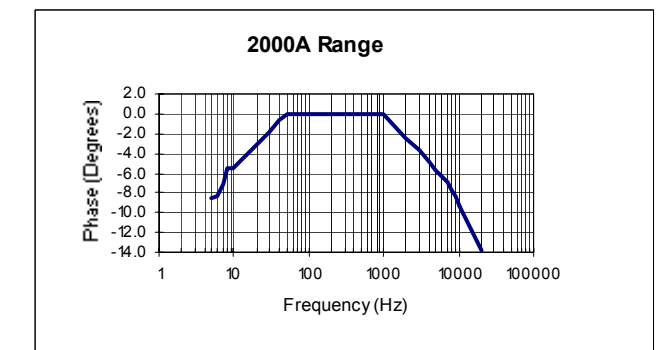

Figure 3. Phase Shift versus Frequency (2000A range)



## Instrument Compatibility

The i2000flex can be used with any Fluke ScopeMeter test tool, Power Quality Analyzer, Oscilloscope, or Multimeter that has the following features:

- BNC input connector. The Dual Banana to BNC Adapter included in the package, can be used to connect to standard inputs on multimeters. For the 120 series ScopeMeters and the Fluke 43 Power Quality Analyzer, use the BB120 Shielded Banana to BNC Adapter (optional accessory).
- Input accuracy of 1% or better to take full advantage of the accuracy of the Current Probe.
- Input impedance of greater than or equal to 1 kΩ, and for full bandwidth and accuracy, a maximum input capacity of 100 pF.
- A passband of more than four times the frequency of the waveform to be measured.

## Using the i2000flex

To use the i2000flex, follow these instructions:

1. Connect the BNC connector of the i2000flex to the desired input on the measuring instrument. When you are using a multimeter, use the Dual Banana to BNC Adapter (PM9081/001) to connect the i2000flex to the input. (See Figure 5.)
2. On the i2000flex unit, select the least sensitive range (set the slide switch to position '1 mV/A').
3. Select the corresponding sensitivity (. . mV/A) on your ScopeMeter test tool or oscilloscope. If you are using a multimeter, select an appropriate AC voltage range.

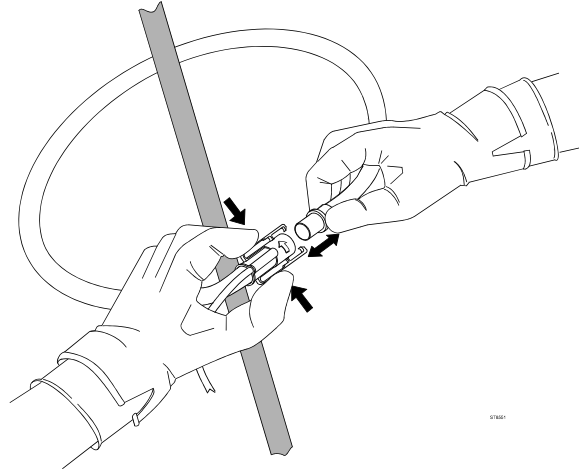

Figure 4. Connecting the flexible probe around the conductor.

4. Connect the flexible probe around the conductor (See Figure 4.)
5. Make sure that the arrow marked on the probe coupling points toward the correct orientation for correct phase display on the oscilloscope. (See Figure 6.)
6. Keep the probe coupling more than 2.5 cm (1 inch) away from the conductor.
7. Observe the current value and waveform on the instrument's display.
8. If desired, select the lower range on the i2000flex unit and set the corresponding sensitivity on the measurement instrument.

If the i2000flex is used with a multimeter, the actual current value can be calculated from the displayed AC voltage value.

**Example 1 :** Current Probe set to 1 mV/A (2000A range). Multimeter displays 1.85Vac rms.

$$\text{Actual current} = \frac{\text{display value}}{\text{sensitivity CurrentProbe}} = \frac{1.85\text{V}}{1\text{ mV / A}} = \frac{1850\text{ mV}}{1\text{ mV / A}} = 1850\text{A ac rms}$$

**Example 2:** Current Probe set to 10 mV/A (200A range). Multimeter displays 750 mVac rms.

$$\text{Actual current} = \frac{\text{display value}}{\text{sensitivity CurrentProbe}} = \frac{750\text{ mV}}{10\text{ mV / A}} = 75\text{A ac rms}$$

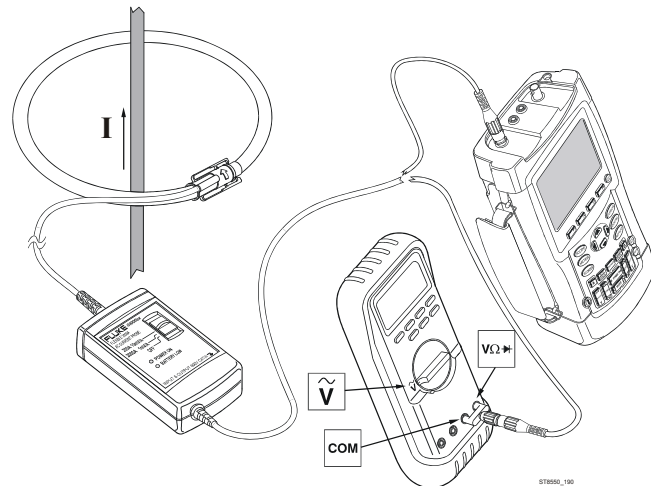

Figure 5. Measurement Setup

## Warning

**If the sensitivity setting (mV/A) of the ScopeMeter test tool or oscilloscope does not correspond with the setting of the Current Probe, the ScopeMeter test tool or oscilloscope may display a much lower current than the actual value. This may result in a false and misleading reading.**

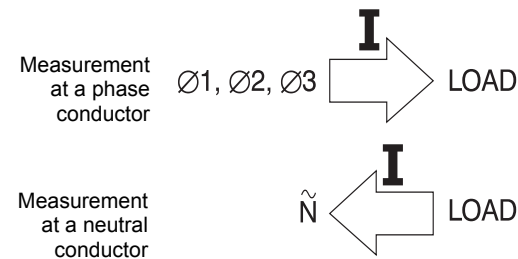

Figure 6. Orientation of the flexible probe

## Measurement Considerations

Though the i2000flex is intended for measurements on hard to reach conductors, observe the following guidelines to approach the maximum measurement accuracy of ±1% of full scale as far as possible:

- Center the conductor perpendicularly inside the flexible probe area. If this is not possible, an additional measurement error of ±2% of full scale can occur.
- Avoid taking measurements close to other current-carrying conductors if possible. An external field of maximum 40 A/m can cause an additional measurement error of 1% of full scale.

The probe coupling must be at least 2.5 cm (1 inch) away from the conductor to which the probe is attached, to meet specified measurement accuracies.

Also see under "Additional errors" in the section "Specifications".

## Maintenance

- Before each use, assure continued safety by inspecting the flexible probe and its latching system for any damage. Pay particular attention to the insulation surrounding the flexible probe. An i2000flex under warranty will be promptly repaired or replaced (at Fluke's discretion) and returned at no charge.

## Cleaning and Storage

- The flexible probe and its latching system require no special care. Ensure that no foreign body obstructs the latching mechanism.
- Clean the i2000flex unit with a damp cloth and a mild detergent. Do not use abrasives, solvents, or alcohol.
- Remove the battery when storing the i2000flex for a long period of time.

## Replacing the Battery

Replace the 9V battery when the 'BATTERY LOW' LED on the i2000flex unit flashes when the power is switched on (a range is selected.)



- To avoid false readings which could cause injury, replace battery as soon as the red Low Battery Indicator flashes.
- Remove the flexible current probe, from any circuit to be measured.
- Set the unit switch to OFF.
- Disconnect the unit from the measurement instrument.

Note:



The i2000flex unit contains an alkaline battery. Do not dispose of this battery with other solid waste. Used batteries should be disposed of by a qualified recycler or hazardous materials handler. Contact your authorized FLUKE Service Center for recycling information.

Follow the steps 1 to 5 depicted in the following figure to replace the battery.

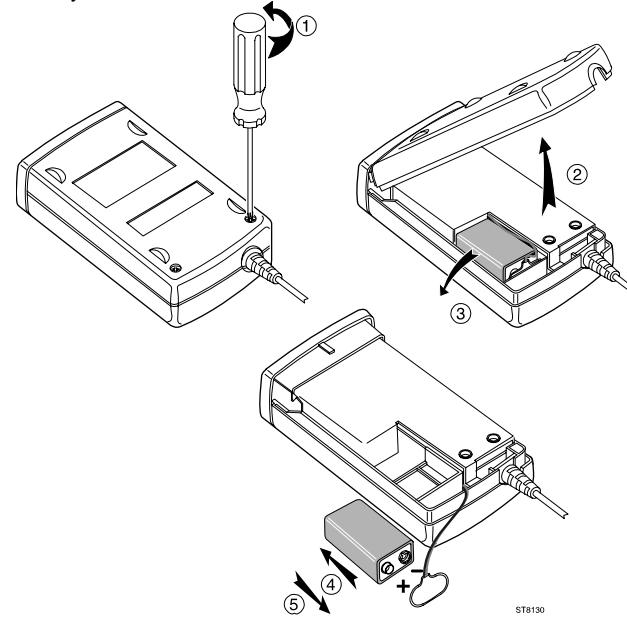

Figure 7. Replacing the battery

## If your i2000flex does not work

If the i2000flex does not perform properly, use the following steps to help isolate the problem:

- Inspect the coupling system for any damage. If any foreign material is present, the coupling system will not close properly and errors will result.
- Inspect the cables between the flexible probe and the unit and between the unit and the measurement instrument for any damage.
- Check if the slide switch on the unit is set to the appropriate current range, matching with the range (or sensitivity) of the measurement instrument.
- Check if the "POWER ON" LED on the unit is flashing, and the "BATTERY LOW" LED is not flashing. Otherwise replace the battery. Also replace the battery if both LEDs stay off.
- Verify that the function selection on the measurement instrument is correct.
- If your measurement instrument has a sensitivity setting for a current probe, select the correct setting (1 mV/A or 10 mV/A).
- If you use a multimeter, preferably select the 2V ac range for full range measurements with best accuracy results.

## LIMITED WARRANTY & LIMITATION OF LIABILITY

This Fluke product will be free from defects in material and workmanship for one year from the date of purchase. This warranty does not cover fuses, disposable batteries or damage from accident, neglect, misuse or abnormal conditions of operation or handling. Resellers are not authorized to extend any other warranty on Fluke's behalf. To obtain service during the warranty period, send your defective product to the nearest Fluke Authorized Service Center with a description of the problem.

THIS WARRANTY IS YOUR ONLY REMEDY. NO OTHER WARRANTIES, SUCH AS FITNESS FOR A PARTICULAR PURPOSE, ARE EXPRESSED OR IMPLIED. FLUKE IS NOT LIABLE FOR ANY SPECIAL, INDIRECT, INCIDENTAL OR CONSEQUENTIAL DAMAGES OR LOSSES, ARISING FROM ANY CAUSE OR THEORY.

Since some states or countries do not allow the exclusion or limitation of an implied warranty or of incidental or consequential damages, this limitation of liability may not apply to you.

Fluke Corporation  
P.O. Box 9090  
Everett WA  
98206-9090, USA

Fluke Industrial B.V.  
P.O. Box 90  
7600 AB Almelo  
The Netherlands

## SERVICE CENTERS

To locate an authorized service center, visit us on the World Wide Web:

<http://www.fluke.com>

or call Fluke using any of the phone numbers listed below:

+1-888-993-5853 in U.S.A. and Canada

+31-40-267-5200 in Europe

+1-425-446-5500 from other countries