

365

Detachable Jaw
True-rms
Clamp Meter

PN 3622684

August 2010

© 2010 Fluke Corporation. All rights reserved. Printed in China. Specifications are subject to change without notice. All product names are trademarks of their respective companies.

LIMITED WARRANTY AND LIMITATION OF LIABILITY

This Fluke product will be free from defects in material and workmanship for three years from the date of purchase. This warranty does not cover fuses, disposable batteries, or damage from accident, neglect, misuse, alteration, contamination, or abnormal conditions of operation or handling. Resellers are not authorized to extend any other warranty on Fluke's behalf. To obtain service during the warranty period, contact your nearest Fluke authorized service center to obtain return authorization information, then send the product to that Service Center with a description of the problem.

THIS WARRANTY IS YOUR ONLY REMEDY. NO OTHER WARRANTIES, SUCH AS FITNESS FOR A PARTICULAR PURPOSE, ARE EXPRESSED OR IMPLIED. FLUKE IS NOT LIABLE FOR ANY SPECIAL, INDIRECT, INCIDENTAL OR CONSEQUENTIAL DAMAGES OR LOSSES, ARISING FROM ANY CAUSE OR THEORY. Since some states or countries do not allow the exclusion or limitation of an implied warranty or of incidental or consequential damages, this limitation of liability may not apply to you.

Fluke Corporation
P.O. Box 9090
Everett, WA 98206-9090
U.S.A.

Fluke Europe B.V.
P.O. Box 1186
5602 BD Eindhoven
The Netherlands

Table of Contents

Title	Page
Introduction.....	1
Contact Fluke	2
Safety Information	2
The Meter	7
Specifications	14
Electrical Specifications.....	14
Mechanical Specifications	15
Environmental Specifications	16

Introduction

⚠️⚠️ Warning

Read "Safety Information" before you use the Meter.

The Fluke 365 is a true-rms hand-held, battery-operated clamp meter (the Meter) that features a detachable Jaw. The Meter measures:

- ac and dc current
- ac and dc voltage
- resistance
- continuity

The Meter ships with:

- TL75 or TL175 test leads
- carrying case
- two AA batteries (installed)
- magnetic hanger
- *365 User Manual*

Contact Fluke

To contact Fluke, call one of the following telephone numbers:

- Technical Support USA: 1-800-44-FLUKE (1-800-443-5853)
- Calibration/Repair USA: 1-888-99-FLUKE (1-888-993-5853)
- Canada: 1-800-36-FLUKE (1-800-363-5853)
- Europe: +31 402-675-200
- Japan: +81-3-3434-0181
- Singapore: +65-738-5655
- China: +86-400-810-3435
- Anywhere in the world: +1-425-446-5500

Or, visit Fluke's website at www.fluke.com.

To register your product, visit <http://register.fluke.com>.

To see, print, or download the latest manual supplement, visit <http://us.fluke.com/user/support/manuals>.

Safety Information

A **Warning** identifies conditions and actions that pose hazard(s) to the user. A **Caution** identifies conditions and procedures that could cause Meter damage, equipment under test damage, or permanent loss of data.

Symbols used on the Meter and in this manual are explained in Table 1.

⚠ ⚠ Warning

To prevent possible electrical shock or personal injury, follow these guidelines:

- Use the Meter only as specified in this manual or the protection provided by the Meter can be compromised.
- Examine the case before you use the Meter. Look for cracks or missing plastic. Carefully look at the insulation around the connectors.
- Never measure current while the test leads are inserted into the input jacks.
- Make sure the battery door is closed and latched before operating the Meter.
- Remove the test leads from the Meter before the battery door is opened.
- Examine the test leads for damaged insulation or exposed metal. Check test lead continuity. Replace damaged test leads before using the Meter.
- Do not use the Meter if it operates incorrectly. Protection can be compromised. When in doubt, have the Meter serviced.
- Do not use the Meter around explosive gas, vapor or in damp or wet environments.
- Use only type AA batteries, properly installed in the Meter case, to power the Meter.
- When measuring, keep fingers behind the Tactile Barrier. See "The Meter" ①.
- To avoid false readings that can lead to electrical shock and injury, replace the batteries as soon as the low battery indicator (⚡) appears.
- When servicing the Meter, use only specified replacement parts.

- **Have the Meter serviced only by qualified service personnel.**
- **Be careful around voltages >30 V ac rms, 42 V ac peak, or 60 V dc. Such voltages pose a shock hazard.**
- **Do not apply more than the rated voltage, as marked on the Meter, between the terminals or between any terminal and earth ground.**
- **When using the probes, keep fingers behind the finger guards on the probes.**
- **Connect the common test lead before connecting the live test lead. When disconnecting test leads, disconnect the live test lead first.**
- **Do not work alone so assistance can be rendered in an emergency.**
- **Use extreme caution when working around bare conductors or bus bars. Contact with the conductor could result in electric shock.**
- **Adhere to local and national safety codes. Individual protective equipment must be used to prevent shock and arc blast injury where hazardous live conductors are exposed.**
- **Disconnect circuit power and discharge all high-voltage capacitors before you do diode tests or measure resistance or continuity.**
- **Do not measure ac/dc current in circuits carrying more than 600 V or 200 A with the Meter Jaw.**
- **Never operate the Meter with the back cover removed or the case open.**

Detachable Jaw True-rms Clamp Meter











Safety Information





Caution

To avoid possible damage to the Meter or to equipment under test:

- Use the proper jacks, function, and range for the measurement application.
- Clean the case and accessories with a damp cloth and mild detergent only. Do not use abrasives or solvents.

Table 1. Symbols

Symbol	Meaning	Symbol	Meaning
	AC (Alternating Current)		Earth ground
	DC (Direct Current)		AC and dc current.
	Hazardous voltage		Risk of Danger. Important information. See Manual.
	Battery. Low battery when shown. The Meter shuts down when the battery reaches 2.0 V.		Double insulated
	Do not dispose of this product as unsorted municipal waste. Go to Fluke's website for recycling information.		Conforms to relevant North American Safety Standards.

Symbol	Meaning	Symbol	Meaning
CAT III	IEC Measurement Category III CAT III equipment has protection against transients in equipment in fixed-equipment installations, such as distribution panels, feeders and short branch circuits, and lighting systems in large buildings.		Application around and removal from HAZARDOUS LIVE conductors is permitted.
	Conforms to European Union directives.		Examined and licensed by TÜV Product Services.
	Conforms to relevant Australian standards.		

Note

The Measurement Category (CAT) and voltage rating of any combination of test probe, test probe accessory, current clamp accessory, and the Meter is the LOWEST rating of any individual component.

Detachable Jaw True-rms Clamp Meter The Meter

The Meter

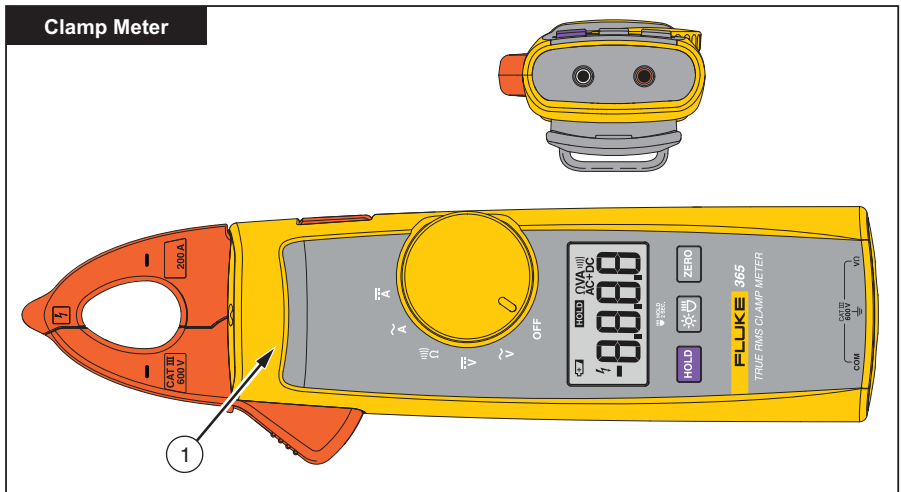

fig01.eps

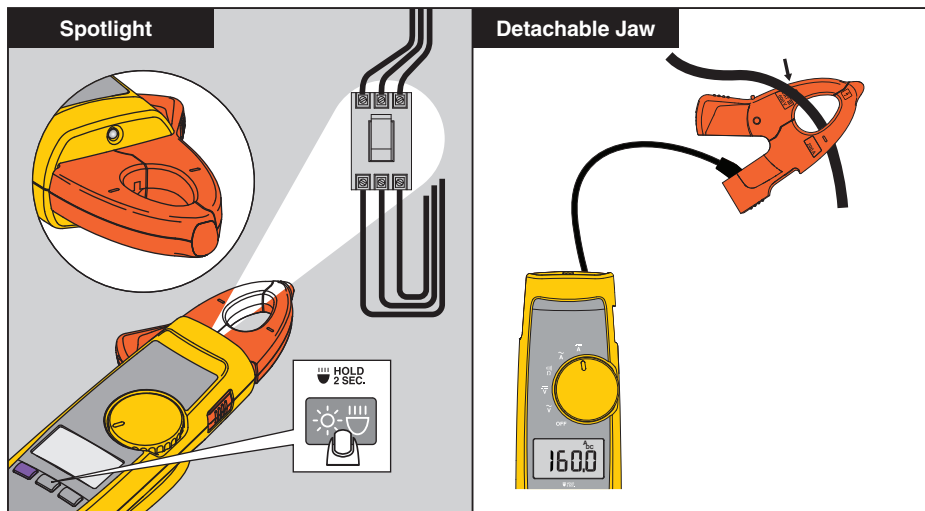

fig12_13_365.eps

Detachable Jaw True-rms Clamp Meter

The Meter

Auto Power Off

88.88

15

HOLD + ON + ZERO =

Backlight

399.9 + =

+ = 399.9

HOLD + ON + =

fig02_3.eps

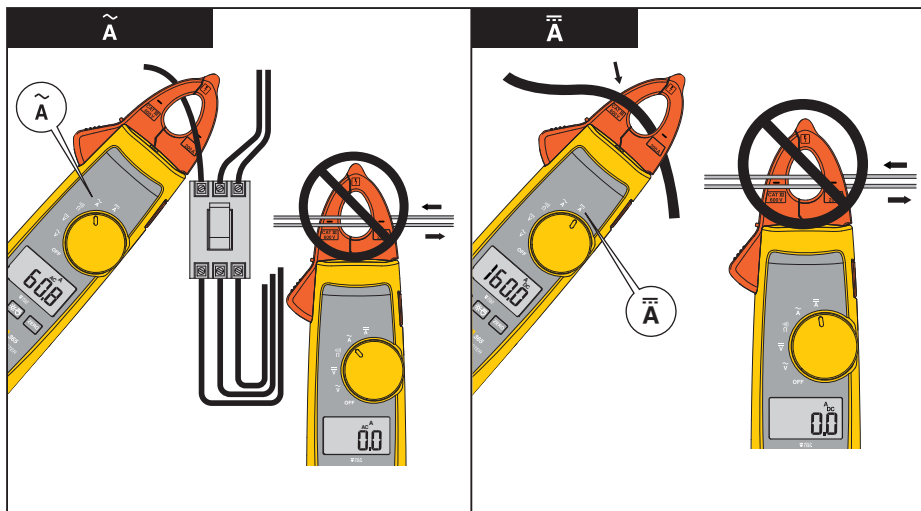

Fig04_05_365.eps

Detachable Jaw True-rms Clamp Meter The Meter

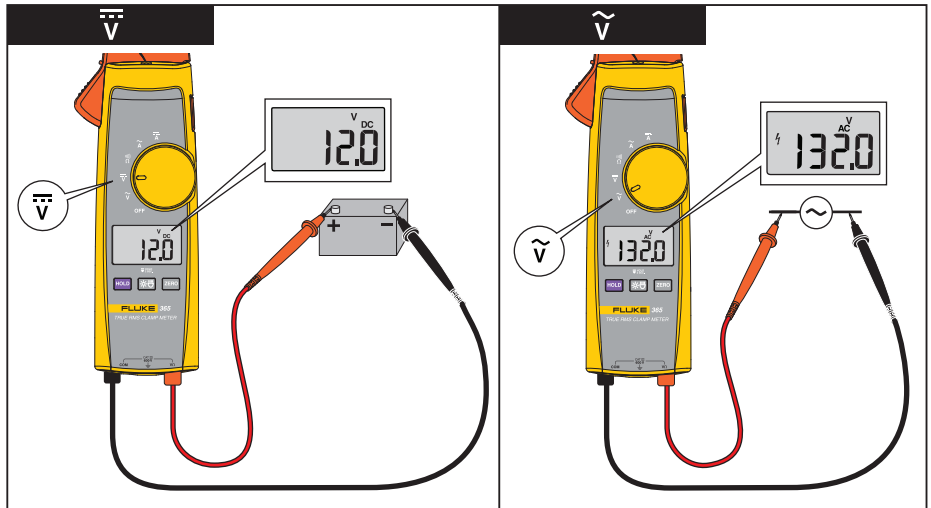

Fig06_07_365.eps

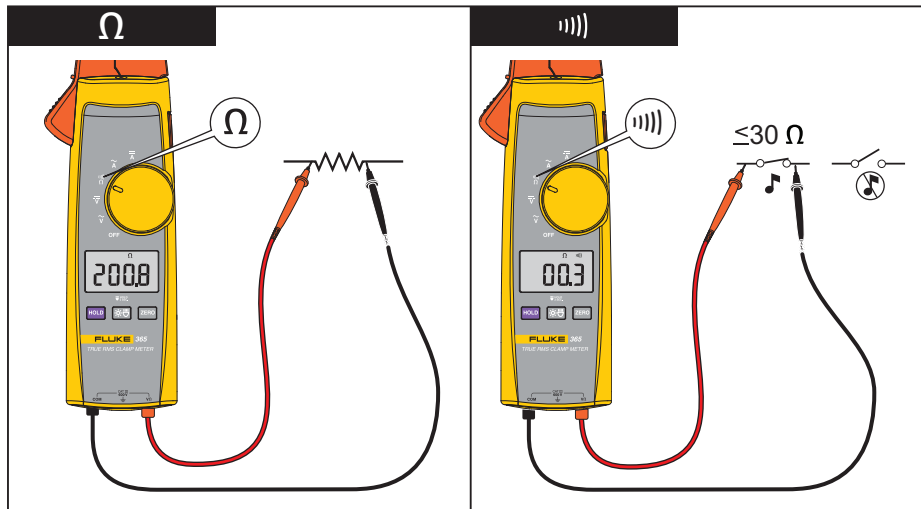

Fig08_09_365.eps

Detachable Jaw True-rms Clamp Meter The Meter

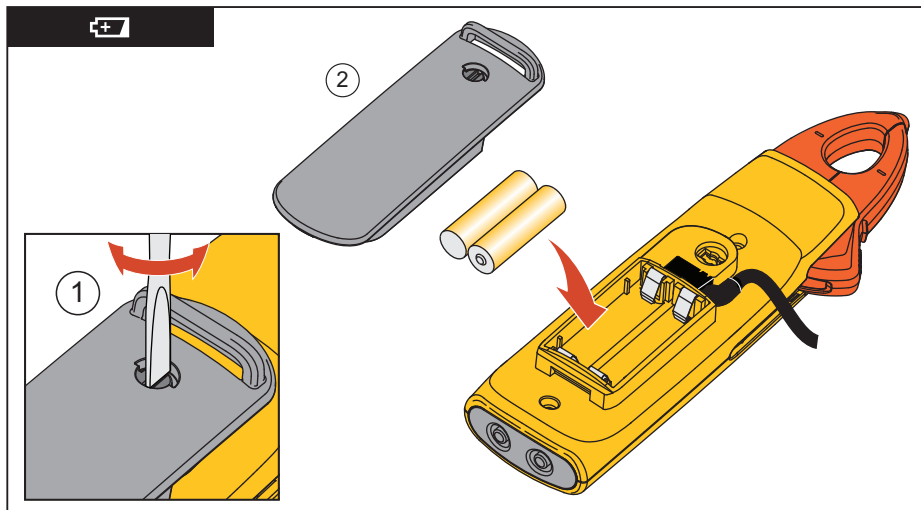

Fig11_365.eps

Specifications

Electrical Specifications

AC Current

Range	200.0 A
Resolution	0.1 A
Accuracy	2 % \pm 5 digits (45 – 65 Hz) 2.5 % \pm 5 digits (65 – 400 Hz)
Crest Factor	2.5 @ 125 A 1.55 @ 200 A Add 2 % for C.F. >2

DC Current

Range	200.0 A
Resolution	0.1 A
Accuracy	2 % \pm 5 digits

AC Voltage

Range	600.0 V
-------------	---------

Detachable Jaw True-rms Clamp Meter Specifications

Resolution	0.1 V
Accuracy	1.5 % \pm 5 digits (45 – 400 Hz)

DC Voltage

Range	600.0 V
Resolution	0.1 V
Accuracy	1 % \pm 5 digits

Resistance

Range	600.0 Ω /6000 Ω
Resolution	0.1 Ω /1 Ω
Accuracy	1 % \pm 5 digits



Mechanical Specifications

Size (L x W x H)	225 x 65 x 46 mm
Weight.....	275 g (including batteries)
Jaw Opening	18 mm
Detachable Jaw Cable Length	900 mm

Environmental Specifications

Operating Temperature.....	-10 °C to +50 °C
Storage Temp	-40 °C to +60 °C
Operating Humidity	Non condensing (<10 °C) ≤90 % RH (at 10 °C to 30 °C) ≤75 % RH (at 30 °C to 40 °C) ≤45 % RH (at 40 °C to 50 °C) (Without Condensation)
Operating Altitude	2000 meters
Storage Altitude	12,000 meters
Temperature Coefficients.....	0.1 x(specified accuracy)/ °C (<18 °C or > 28 °C)

Detachable Jaw True-rms Clamp Meter Specifications

Safety Compliance.....	ANSI/ISA S82.02.01:2004 CAN/CSA-C22.2 No. 61010-1-04 UL 61010-1:2004 EN/IEC 61010-1:2001 to 600V CAT III Pollution Degree 2 CE
Agency Approvals.....	  
Batteries.....	2 AA, NEDA 15A, IEC LR6

