

SP60H Handheld Thermal Camera



The HIKMICRO SP60H high-performance handheld thermal camera is ideal for industrial, predictive, oil and gas, and utility maintenance inspections.

HIKMICRO SP60H has a high sensitivity (NETD < 30 mK) and high resolution (640 × 480) HIKMICRO VOx detector, and the temperature calibration is up to 2200°C. This flexible and ergonomic thermal imager provides an electronic viewfinder and a 180° rotating lens, making long-day outdoor inspections easier. Advanced features help thermal imaging professionals to easily survey equipment and find signs of malfunction, such as GPS and compass annotations, continuous digital zoom, and 1-Tap level and span.

Connect HIKMICRO Viewer App or HIKMICRO Analyzer software to transfer, analyze, and share pictures, and generate reports for free.

▪ Key Features

- Thermal resolution: 640 x 480 (307 200 pixels),NETD : < 30 mK (@ 25 °C,F#=1.0)
- Temperature measurement range : -40°C to 2200°C (-40°F to 3992°F)
- Accuracy: Max. (±1°C (±1.8°F): 0 to 100°C (32 to 212°F); ±1%: 100 to 150°C (212 to 302°F))
- The 90° rotating screen and the 180° rotating lens design
- 1024 x 768 OLED electronic viewfinder and auto-brightness 5-inch color LCD display
- 1.x to 12.x continuous digital zoom
- Manual, automatic, and 1-Tap Level and Span
- GPS & compass annotation functions
- 30 Hz image frequency
- Up to 4 hours continuous running

▪ Specification

Infrared Image	
IR Resolution	640 × 480 (307,200 pixels)
SuperIR	1280 × 960 (1,228,800 pixels)
NETD	< 30 mK (@ 25 °C, F#=1.0)
Image Frequency	30 Hz
Detector Pitch	17 μm
Spectral Range	7.5 to 14 μm
Focal Length	L8: 77.4 mm; L12: 51.4 mm; L25: 25.6 mm; L50: 12.6 mm
F-number	L8: F1.2; L12: F1.1; L25: F1.0; L50: F1.0
Field of View (FOV)	L8: 8° × 6°; L12: 12° × 9°; L25: 24.5° × 18.4°; L50: 50° × 37.3°
Spatial Resolution (IFOV)	L8: 0.22 mrad; L12: 0.33 mrad; L25: 0.66 mrad; L50: 1.35 mrad
Min. Focus Distance	L8: 2 m (6.56 ft); L12: 1 m (3.3 ft); L25: 0.15 m (0.49 ft); L50: 0.15 m (0.49 ft)
Focus Mode	Laser Assisted AF/Continuous AF/AF/Manual Focus/Touch AF
Focus Speed	Approx. 1 second
Image Display	
Visual Camera	3264 × 2448 (8 MP)
Display	1280 × 720 Resolution, 5" LCD Touch Screen
Screen Brightness	Manual/Auto
Viewfinder	1024 × 768 pixels OLED
Digital Zoom	1.x to 12.x continuous
Color Palettes	White Hot, Black Hot, Rainbow, Ironbow, Red Hot, Fusion, Rain, Blue Red
Focus Mode Palette	Above/Below/Interval
Color Alarm	Above/Below/Interval/Insulation
Image Modes	Thermal/Visual/Fusion/PIP/Blending
Measurement and Analysis	
Object Temperature Range	-40°C to 2200°C (-40°F to 3992°F)
Accuracy	±1°C (±1.8°F): 0 to 100°C (32 to 212°F); ±1%: 100 to 150°C (212 to 302°F); ±2°C (±3.6°F): -40 to 0°C (-40 to 32°F); ±2%: 150 to 2200°C (302 to 3992°F)
Measurement Tools	Center Spot, Hot Spot, Cold Spot User-definable: Delta T, 10 spots, 1 line, 5 rectangles, and 5 circles
Level and Span Mode	Auto/Manual/1-Tap Touch-Screen
Inspection Route	Yes
Data Storage and Communication	
Storage Media	Removable 128 GB SD Card
Image Storage Capacity	Approx. 120,000 Images
Annotations	Voice note: max. 60 seconds; Text note: max. 200 characters
Video Storage Capacity	Approx. 500 hours

Video File Format	MP4 video and radiometric video
Image Format	Radiometric JPEG
Radiometric Infrared-Video Streaming (Compressed)	Over UVC, Wi-Fi
General	
Wi-Fi	802.11 b/g/n (2.4 GHz and 5 GHz)
Bluetooth	Bluetooth 4.2
USB Interface	USB Type-C
HDMI Interface	HDMI-D
Laser Pointer	Yes
LED Light	Yes
Laser Distance Meter	Indoor distance: 50 m (164 ft); Outdoor distance: 10 m (33 ft).
Laser	Yes, Class II, Wavelength: 635 nm; Power: < 1 mW
Battery Type	Interchangeable and rechargeable Li-ion battery
GPS & Compass	Yes
Battery Operating Time	Approx. 4 hours
Battery Charging Time	Approx. 2.5 hours fully charged
Power Saving Mode	Yes
Programmable Buttons	2
Protection Level	IP54, IEC 60529
Drop Test Height	1 m (3.28 ft), IEC 60068-2-31
Safety	IEC 61010-1
EMC	EN 301 489-1, EN 301 489-17, EN IEC 61000-6-2, EN IEC 61000-6-4, EN 61326-1
Vibration	2 g, IEC 60068-2-6
Shock	25 g, IEC 60068-2-27
Working Temperature Range	-20°C to 50°C (-4°F to 122 °F)
Storage Temperature Range	-20°C to 60°C (-4°F to 140°F)
Relative Humidity	< 95% non-condensing
Weight	Approx. 1481 g (3.27 lb)
Dimension	210.1 × 151.9 × 87.8 mm (8.27 × 5.98 × 3.45 in)
Tripod Mounting	UNC ¼" -20
Warranty	3 years for the full product, 10 years for the detector, and 2 years for the battery.

▪ Available Model

HM-TP96H-Q/W-SP60H-L8

HM-TP96H-Q/W-SP60H-L12

HM-TP96H-Q/W-SP60H-L50

HM-TP96H-Q/W-SP60H-L25

▪Dimension

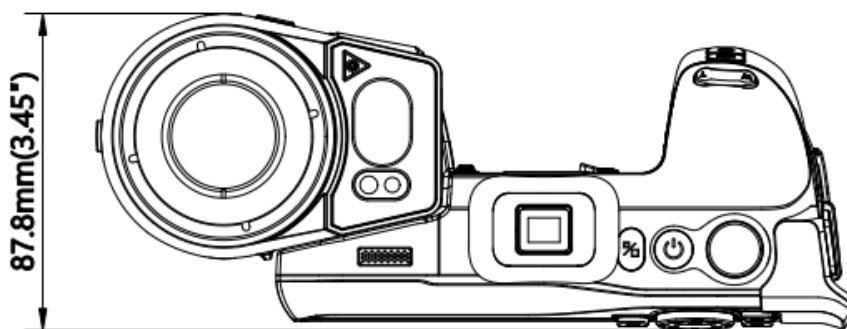
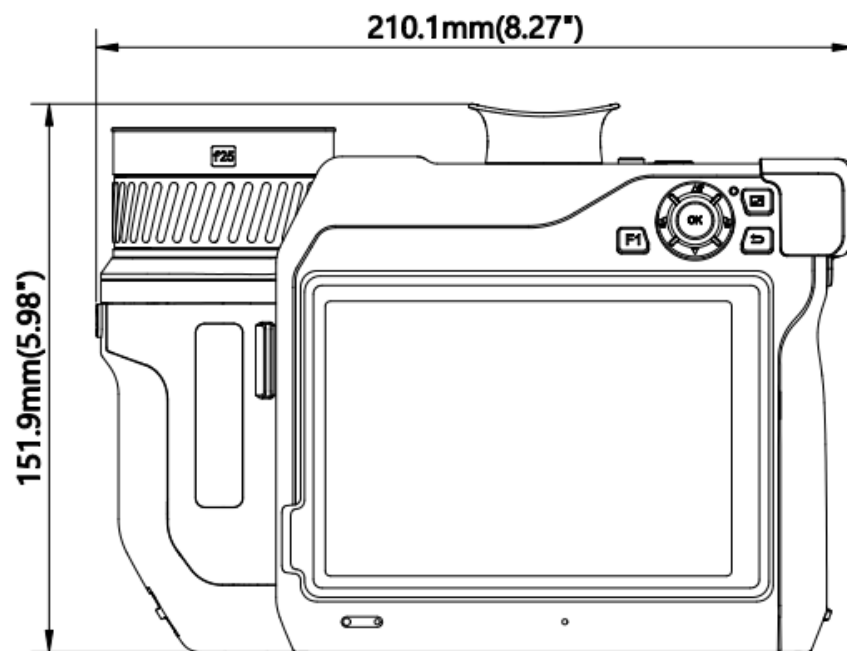

▪ Packaging

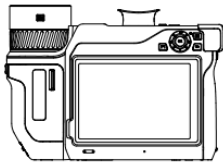

Camera(x1)

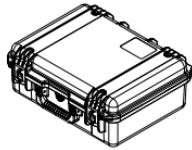

Hard Carrying Case(x1)



QSG(x1)

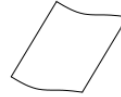

Non-Dust Cloth(x1)



Lens Caps(x1)

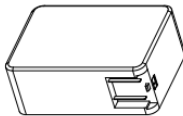

Adapter(x1)

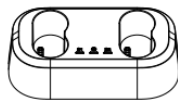

Charging Base(x1)



USB Cable(x2)



Wrist Strap(x1)



Adapter Plug(x4)



Battery(x2)



HDMI Cable(x1)



Neck Strap(x1)

▪ Accessory

▪ Optional

HM-20322ZC
SP Series Battery
Charger



HM-7250DC
SP Series Battery



HM-SP620-MACRO
SP Series Macro Lens



HM-SP605-LENS
SP Series 0.5X Wide
Angle Lens



HM-SP610-LENS
SP Series 1X
Telephoto Lens



HM-SP620-LENS
SP Series 2X
Telephoto Lens



HM-SP630-LENS
SP Series 3.3X
Telephoto Lens



HM-SP01-POUCH
M/G/SP Series Pouch



HM-SP650-MACRO
SP Series Macro Lens
50 μ m



HM-AHBR01
SP Series Desktop
Stand Bracket





COMPLIANCE NOTICE: The thermal series products might be subject to export controls in various countries or regions, including without limitation, the United States, European Union, United Kingdom and/or other member countries of the Wassenaar Arrangement. Please consult your professional legal or compliance expert or local government authorities for any necessary export license requirements if you intend to transfer, export, re-export the thermal series products between different countries.



 HIKMICRO Thermography  hikmicro_thermography  HIKMICRO Thermography  HIKMICRO  info@hikmicrotech.com  <http://hikmicrotech.com/en>

© Hangzhou Microimage Software Co., Ltd. All Rights Reserved.

*Note: Specifications are subject to change without notice. For the current specs,
please go to www.hikmicrotech.com