

WÖHLER

Operation Manual Suspended Particulate Analyser



Wöhler SM 500

Order No.: 22885 – 2022-08-09

The measure of technology

Contents

1	General Information.....	5
1.1	Operation Manual Information.....	5
1.2	Notes.....	5
1.3	Proper Use.....	5
1.4	Components.....	6
1.5	Transport.....	6
1.6	Information on disposal.....	7
1.7	Manufacturer.....	7
2	Technical Data.....	8
2.1	Measurement readings.....	8
2.1.1	Suspended Particulate Matter Concentration	8
2.1.2	Measurement readings Flue gas analysis.....	9
2.2	Calculated Values.....	10
2.3	Technical Data.....	11
2.3.1	Technical Data.....	11
2.3.2	Technical Data of peripheral devices.....	11
3	Design and function.....	12
3.1	Components.....	12
3.2	Control unit.....	14
4	Setting up and dismantling the analyser.....	18
4.1	Setting up the analyser.....	18
4.2	Dismantling the analyser (please refer also to Fig. 1).....	20
4.3	Probe connections.....	22
4.3.1	Probe and cable-hose assembly for core flow search and draft measurement.....	22
4.3.2	Probe and cable-hose assembly for flue gas analysis.....	23
4.3.3	Particulate-matter sampling probe for TSPM mass concentration measurements.....	23
4.4	Handling the heated intake hose.....	24
4.4.1	Hose bend radius.....	24

4.4.2	Attaching the intake hose to the control unit	24
4.4.3	Movements when measuring	25
5	TSPM mass concentration measurements	26
5.1	Planning measurements	26
5.1.1	Measurement orifice	26
5.1.2	Measurement phases	26
5.2	Switching on	27
5.3	Leak tightness test	28
5.4	Selecting a threshold value	29
5.5	Stabilizing phase	30
5.6	Screens displayed during measurement	33
5.7	Results display	35
5.8	Following every analysis	36
6	Menu	37
6.1	Submenu "TSP mass meas."	39
6.2	Submenu "Flue gas analysis"	39
6.3	Submenu "Print result"	41
6.4	Submenu "Data"	43
6.4.1	Customer	43
6.4.2	New record	44
6.4.3	Print records	45
6.4.4	Delete	45
6.5	Submenu "Save"	46
6.6	Submenu "Test"	47
6.6.1	Mass	48
6.6.2	VolF: 4.5 NL/min and volF: 3.0 NL/min	51
6.6.3	Flue gas analysis	51
6.7	Submenu "Settings"	54
6.8	Submenu "Calibration"	55
7	Maintenance	56
7.1	Inspection and maintenance list	57
7.2	Emptying condensate and replacing the fleece filter	58

7.3	Replacing the cotton filter in the case.....	60
7.4	Cleaning the heated intake hose.....	60
7.5	Cleaning the digital mass scale unit.....	65
7.6	Checking the hose temperature sensor, clean if necessary.....	66
7.7	Sensor Replacement.....	73
8	Control functions / faults	75
8.1	Self-test.....	75
8.2	Control functions	75
9	Warranty and Service	78
9.1	Warranty.....	78
9.2	Service	78
10	EC Conformity.....	79
11	Accessories.....	80

1 General Information

1.1 Operation Manual Information

This operation manual allows you to work safely with the Wöhler SM 500 Suspended Particulate Analyzer. Please keep this manual for your information.

The Wöhler SM 500 suspended particulate analyzer should be employed by professionals for its intended use only. Liability is void for any damages caused by not following this manual.

1.2 Notes



WARNING!

Not following this warning can cause injury or death.



ATTENTION!

Not following this note can cause permanent damage to the device.



NOTE!

Useful information

1.3 Proper Use

The Wöhler SM 500 Suspended Particulate Analyser is approved for online mass concentration measurements of total suspended particulate matter (TSPM) at small solid fuel firing installations in accordance with the 1st. BImSchV (German Federal Immission Control Act) of 26th January 2010. The Wöhler SM 500 Suspended Particulate Analyser is not suitable for continuous operation. A complete analysis takes 15 minutes. The analyser is designed for indoor use only. It corresponds to instrument categories A₁₅₀/B₁₅₀, C₁₅₀ to A₂₀/B₂₀/C₂₀. in accordance with VDI 4206 Part 2 (VDI = Association of German Engineers). In accordance with § 3 of 1st BImSchV it is suitable for use with the following fuels:

Class A: Natural wood (4, 5 and 5a)

Class B: Wood materials, straw and grain
(6, 7 and 8)

Class C: Coal (1,2 and 3)

1.4 Components

Device	Components
Wöhler SM 500 Suspended Particulate Analyser	High precision digital mass scale unit
	Flue gas condenser
	Heated probe and hose assembly
	Control cable 1,10 m
	Probe and hose assembly, 2950 mm, for flue gas analysis SM 500
	Mains cord 2,5 m
	Flue gas hose 2,5 m
	2 x hose assembly at the condensate trap
	Heavy duty carrying case Wöhler SM 500
	Mini scraper
	Pack with filter cartridges

1.5 Transport



ATTENTION!

Remove the filter cartridge before transporting the device .

Always transport the meter in the provided carrying case in order to prevent damage. Store all parts in the heavy duty case as described in chapter 4 and close the case carefully. For transportation, put the foam ring on the filter cartridge in the mass scale unit. In chapter 4.4 you will find notes for handling the heated hose assembly.

1.6 Information on disposal



Electronic equipment does not belong into domestic waste, but must be disposed in accordance with the applicable statutory provisions.

1.7 Manufacturer



Wöhler Technik GmbH

Wöhler-Platz 1

D-33181 Bad Wünnenberg

Tel.: +49 2953 73-100

Fax: +49 2953 7396-100

E-Mail: international@woehler.de

2 Technical Data

2.1 Measurement readings

2.1.1 Suspended Particulate Matter Concentration

Filter load (m_{STF}) in 15 min	
Reading	Filter load in mg at a deposition temperature of 75°C
Sensor technology	Gravimetric online weighting procedure
Range	0,0 - 45,0 mg (corresponds to 0,0 mg/m ³ - 1000,0 mg/m ³ in the flue gas where O ₂ = O _{2ref})
	10 to 300 mg/m ³ approved according to VDI 4206-2
Accuracy	Better than ± 0,3 mg
Sample rate (Vols)	
Reading	Standard litres per minute
Sensor technology	Differential pressure
Range	4,5 L _{i.N.} /min and 3,0 L _{i.N.} /min
Accuracy	Better than ± 5%
Oxygen (O₂) concentration in flue gas	
Reading	Volume % referred to dry flue gas
Sensor technology	electrochemical
Range	0,0 to 21,0 Vol.-%
Accuracy	± 0,3 Vol.-% according to VDI 4206 sheet 1

Carbon monoxide (CO_v) in flue gas	
Reading	Volume ppm referred to dry flue gas
Sensor technology	electrochemical
Range	0 to 100.000 Vol.-ppm, resolution 1 Vol.-ppm (< 32.000 ppm), else 10 ppm
Accuracy	± 100 Vol.ppm (< 1000 ppm), else 10% of reading, according to VDI 4206 sheet 1
Draft (PD)	
Reading	Pascal
Sensor technology	Semiconductor
Range	0,00 to ± 10,00 hPa, resolution 1 Pa
Accuracy	3 Pa (<100Pa), else 3% of reading
Flue gas temperature (TA)	
Reading	°C
Sensor technology	Thermocouple (NiCr-Ni)
Range	-20,0 °C to 800,0 °C resolution 0,5 °C
Accuracy	±2°C up to 133°C, else 1,5 % of reading

**2.1.2 Measurement readings
Flue gas analysis**

2.2 Calculated Values

Reading	Explanation
m _{St}	Total suspended particulate matter mass concentration in flue gas referred to the adjustable oxygen reference value in mg/m ³ . BImSchV vom 26. Januar 2011, darüber hinaus bis 1000 mg/m ³ in TÜV-Prüfung nachgewiesen.
Vol	Sample volume in SL
O ₂	O ₂ concentration in % given as 15 min average value
CO _V	CO concentration in ppm given as 15 min average value
CO _N	CO air free concentration in ppm referred to the adjustable oxygen reference value

2.3 Technical Data

2.3.1 Technical Data

Description	Data
Power supply	Mains operation
Efficiency	1200 W max.
Voltage	230V, 50Hz
Storage Temperature	-20 °C to 50 °C
Work temperature	+5 °C to 40 °C
Relative humidity	10% - 70 %
Weight	approx. 14 kg
Dimensions	480 x 240 x 550 mm
Operating life of the O ₂ cell and the CO cell	approx. 2 years

2.3.2 Technical Data of peripheral devices

Description	Data
Suspended particulate probe	VA pipe 4 mm Aperture 9,74 mm conical Length: 350 mm
Heated hose	Length 2000 mm
Wöhler filter cartridge	19,8 mm Ø Size: 12 mm, T _{max} : 100°C
Probe and hose assembly for flue gas analysis	Length of the hose 1700 mm

3 Design and function

3.1 Components

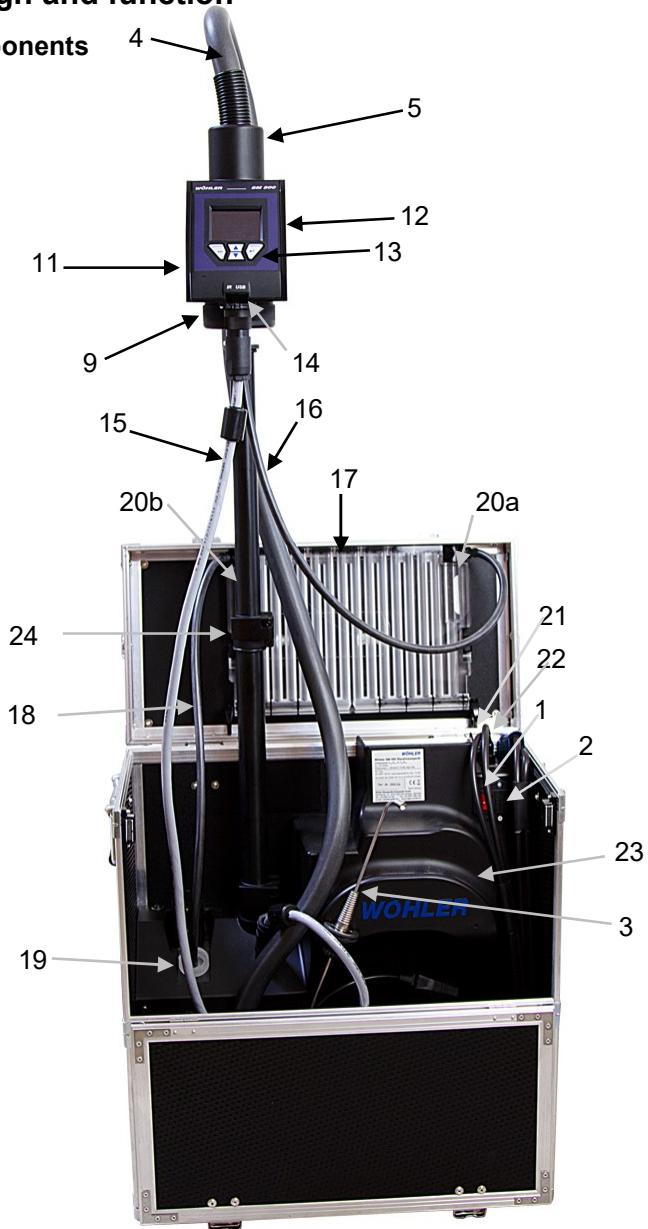

Fig. 1: Analyser components

Diagram key

** The components listed below are hidden from view inside the analyser in the photo (Fig. 1); however, they are depicted in the drawing in Fig. 3. The components 6, 7, 8 and 10 are located in or behind the control unit.*

The components 25-29 are located in the bottom compartment of the case.

- 1 On/Off switch
- 2 Power supply connection (hidden from view in the photo by a hose)
- 3 Particulate-matter sampling probe
- 4 Heated sample intake hose
- 5 Hose temperature sensor (located below the cover)
- 6 Digital mass scale unit*
- 7 Feed tube to filter holder*
- 8 Filter cartridge*
- 9 Screw cap
- 10 Power supply connection for hose heater*
- 11 Hose clamp for heated intake hose (hidden from view in the photo by control unit)
- 12 Control unit housing the high precision digital mass scale unit
- 13 4 key operator control panel
- 14 USB connection and infrared port for printouts
- 15 Control cable
- 16 Connecting hose
"digital mass scale unit – flue gas condenser"
- 17 Flue gas condenser
- 18 Connecting hose
"flue gas condenser - case"
- 19 Hose connection with cotton filter
- 20 Fleece filter
- 21 Connection for probe and cable-hose assembly to measure flue gas temperature
- 22 Connection for probe and cable-hose assembly to measure differential pressure in the stack
- 23 Reel to store heated intake hose
- 24 Telescopic stand with clamps
- 25 Standard volume flow rate measurement*
- 26 Controlled pump*
- 27 Diaphragm pump for gas sensors
- 28 O₂ and CO gas sensors
- 29 Flue gas exhaust hose to exhaust flue gas out of analyser

3.2 Control unit



Fig. 2: Front view of control unit

The digital mass scale unit of the SM 500 is located at working height on top of the extended telescopic stand. It is equipped with a control unit and integrated display to facilitate full visual control of the analysis process.

The Wöhler SM 500 is operated using four multiple function keys. Each key function is context sensitive; the function is indicated in the lower part of the display. Both middle keys are active for scrolling; in all other cases, the upper middle key only is active.

Schematic overview of gas and signal paths

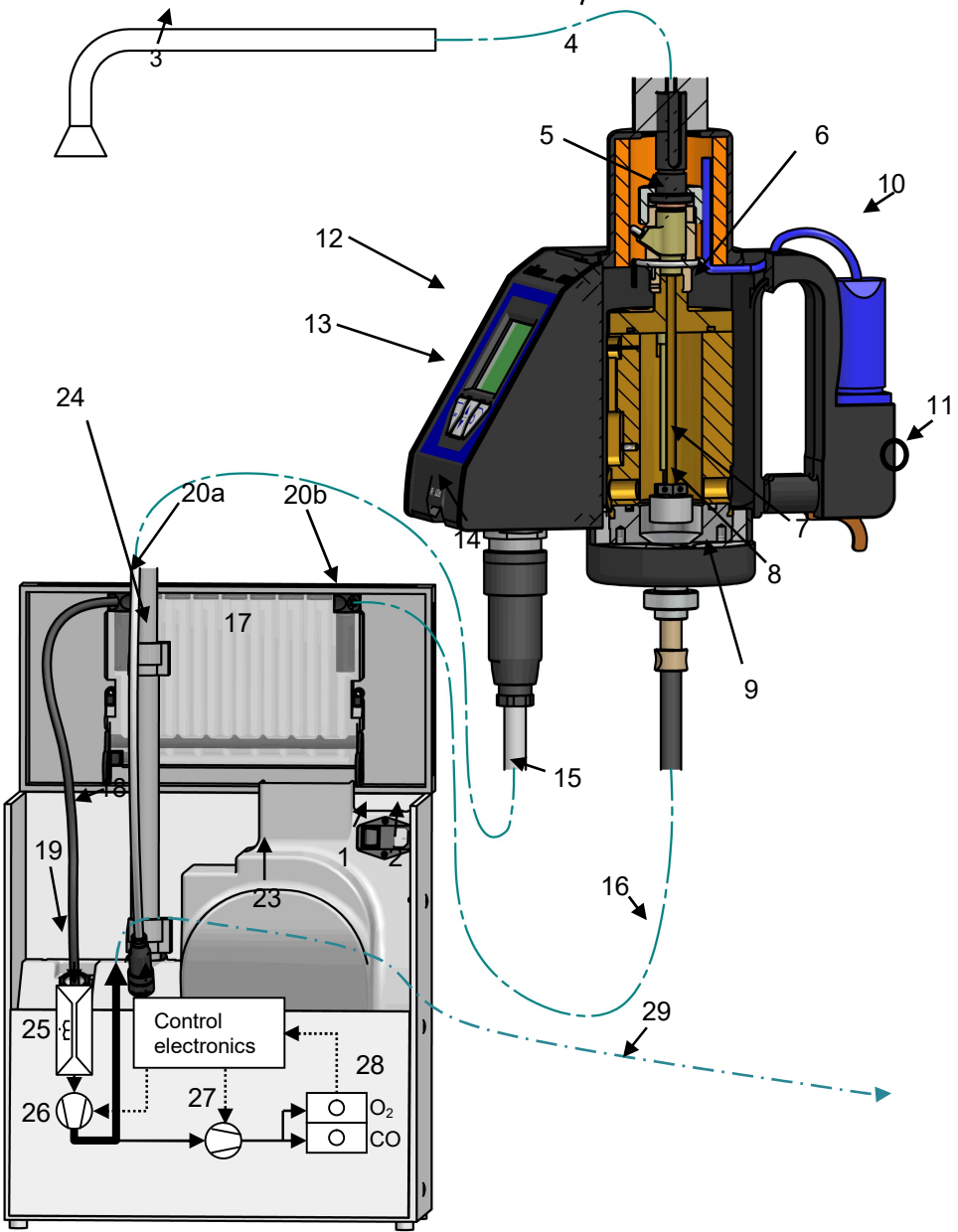

Fig. 3: Schematic overview of gas and signal paths

Diagram key

Components 21 and 22 are visible in Fig. 1, but they are not included in this drawing (Fig. 3).

- 1 On/Off switch
- 2 Power supply connection
- 3 Particulate-matter sampling probe
- 4 Heated sample intake hose
- 5 Hose temperature sensor
- 6 Digital mass scale unit
- 7 Feed tube to filter holder
- 8 Filter cartridge
- 9 Screw cap
- 10 Hose heater supply connection
- 11 Holder for the heated sample intake hose
- 12 Control unit housing the high precision digital mass scale unit
- 13 4 key operator control panel
- 14 USB connection and infrared port for printouts
- 15 Control cable
- 16 Connecting hose "digital mass scale unit – flue gas condenser"
- 17 Flue gas condenser
- 18 Connecting hose "flue gas condenser - case"
- 19 Hose connection with cotton filter
- 20 Fleece filter
- 21 Connection for probe and cable-hose assembly to measure flue gas temperature
- 22 Connection for probe and cable-hose assembly to measure differential pressure in the stack
- 23 Reel to store heated intake hose
- 24 Telescopic stand with clamps
- 25 Standard volume flow rate measurement
- 26 Controlled pump
- 27 Diaphragm pump for gas sensors
- 28 O₂ and CO gas sensors
- 29 Flue gas exhaust hose to exhaust flue gas out of analyser

Description (refer to Figures 1 and 3)

Extracted flue gas is fed via the particulate-matter sampling probe (3) and the heated intake hose (4) and the equally thermally controlled digital mass scale unit (6). To regulate the temperature of the heated intake hose, a hose temperature sensor (5) is located in the fitting between the heated intake hose and the upper inlet of the digital mass scale unit. The filter cartridge (8) in the digital mass scale unit is inserted onto the filter holder at the end of the feed tube (7). Fine particulate matter separates inside the filter cartridge during the analysis, which makes it possible to determine the concentration of particulate matter in the flue gas by comparing the increase in particulate matter mass and the extracted sample volume.

The flue gas exits the heated area via the screw cap (9) and the hose "digital mass scale unit – flue gas condenser" (16) before reaching the flue gas condenser (17). Here the gas flows first through a fleece filter (20a), continues to cool in the drilled channels and condenses before arriving at the pump unit and analysis via a second fleece filter (20b) and the connecting hose "flue gas condenser – case" (18).

The cotton filter (19) at the inlet in the case provides an additional safeguard against the ingress of condensate and dusts.

A metering unit (25) is housed in the case to regulate the rotary vane pump (26) and maintain a constant volume flow rate.

A diaphragm pump (27) connected to the output of the rotary vane pump feeds a part of the flue gas to the gas sensors (28) for analysis.

The flue gas exhaust hose (29) routes the extracted gas out of the analyser.

4 Setting up and dismantling the analyser

4.1 Setting up the analyser



Fig. 4: Extending the telescopic stand



CAUTION!

Before setting up the analyser, ensure it is positioned on a flat, non-slip surface.

Proceed as follows to set up the analyser (see Fig. 1)

- Open the case.
- Remove the hoses belonging to the probe and cable-hose assembly and the power cable from the case to allow you to grip the telescopic stand comfortably.
- Undo the clamps belonging to the telescopic stand (24). Raise the telescopic stand slightly and remove the heated intake hose (4) from the case. Observe the notes in chapter 4.4 when handling the heated intake hose.
- Raise the telescopic stand until the control unit (12) is positioned at working height. Tighten the clamps to secure the telescopic stand in position.

The control unit (12) is still tilted at this point.

- Unscrew the screw cap (9) and insert a filter cartridge as described in chapter 0. Screw the cap (9) back on again.
- Pull the locking latch of the control unit (12) outwards, then rotate the control unit upright. The locking latch will automatically snap into position.

Locking latch



Fig. 5: Undo the locking latch on the digital mass scale unit



PLEASE NOTE!

It is possible to remove the digital mass scale unit from telescopic stand of the Wöhler SM 500 and fit it onto an external telescopic stand (accessory) to carry out measurements.

To do so simply pull the locking latch outwards when the digital mass scale unit is tilted (refer to the image opposite).

It is now possible to remove the module from the telescopic stand.



Fig. 6: Fastening the intake hose holder

- Secure the heated intake hose (4) to the holder (11) below the power supply connection



PLEASE NOTE!

The upper part of the heated intake hose should be bent round approximately 90°.

- Place the flue gas exhaust hose (29) outside of the case to allow flue gas to exhaust out of the analyser (see Fig. 3).
- Connect the analyser to the power supply using the power cable included in the scope of supply.



PLEASE NOTE!

The particulate-matter sampling probe can easily be affixed to the case before and after taking measurements by placing the marking aid onto a case screw.

4.2 Dismantling the analyser (please refer also to Fig. 1)



Fig. 7: Analyser components stowed in case

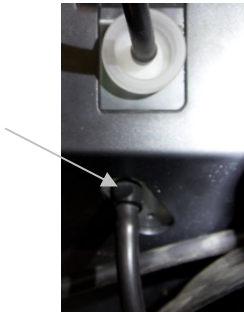

Fig. 8: Flue gas hose with bayonet joint



PLEASE NOTE!

It is not necessary to remove the hoses when dismantling the analyser. The hoses need only be disconnected for maintenance purposes, see chapter 7 (Maintenance).

- Remove the power cable from the mains power supply.
- Tilt the control unit (12) to the right (when viewed from the front)
- Undo the clamps of the telescopic stand (24) and close it down as far as it will go.



PLEASE NOTE!

Begin guiding the heated intake hose around the reel (23) with large radii as soon as you begin to close the telescopic stand

- Place the particulate-matter sampling probe (3) into the holder provided on the left of the reel (23).
- Remove the flue gas exhaust hose (29) after the measurement. (Turn the bayonet joint to the left.)
- Roll up the flue gas exhaust hose (29) and place it into the case.
- Place the probe and cable-hose assembly for flue gas analysis into the case.
- Close the case.

Changing the filter cartridge



Fig. 9: Changing the filter

- Tilt the control unit (12) to one side.
- Unscrew the screw cap (9) of the digital mass scale unit.

The filter cartridge is now exposed.

- Withdraw the used filter cartridge. Make sure your hands are clean (thumb and forefinger) before carefully inserting the new Wöhler filter cartridge until it is fully seated. Avoid making any rotary movements.



Fig. 10: Filter cartridge visibly loaded

! CAUTION!

Do not use a Wöhler filter cartridge to take further measurements when it is visibly fully loaded with particulate matter.

! CAUTION!

Do not make any rotary or screwing motions when removing or inserting the Wöhler filter cartridge.

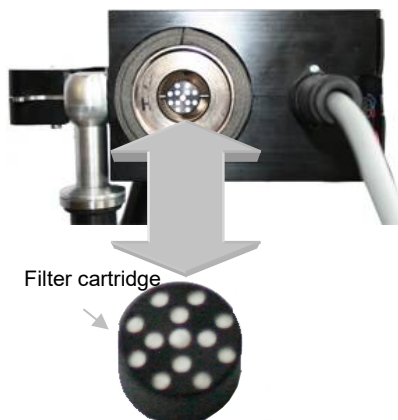

Fig. 11: Changing the filter cartridge

- Then screw the cap (9) back on again.

4.3 Probe connections

4.3.1 Probe and cable-hose assembly for core flow search and draft measurement



Fig. 12: Connecting the probe and cable-hose assembly

Core flow and draft must be determined during the heating and stabilizing phase of a TSPM mass concentration measurement program.

- Connect the probe and cable-hose assembly for flue gas analysis as shown in the image opposite.



PLEASE NOTE!

This is the usual connection configuration of the probe and cable-hose assembly. There is no need to rearrange the connections.

The 15-minute mean oxygen and carbon monoxide concentration values are determined automatically as the flue gas drawn in via the particulate-matter sampling probe is analysed (see Fig. 3)

4.3.2 Probe and cable-hose assembly for flue gas analysis



Fig. 13: Connection for flue gas analysis (special circumstances!)

Proceed as follows if, on rare occasions, you require a preliminary assessment of the firing installation based on O₂ and CO concentrations prior to a TSPM mass concentration measurement:

- Remove the connecting hose "digital mass scale unit – condenser" from the condenser with a screwing motion (Fig. 1, pos. 16).
- Connect the gas connection of the probe and cable-hose assembly to the connection at the condenser inlet with a twisting motion (refer to the image opposite).
- From the main menu of the Wöhler SM 500 select the menu item "Flue gas analysis", and then proceed as described in chapter 6.2.

! CAUTION!

It is imperative that the connecting hose "digital mass scale unit - condenser" is disconnected only for the purpose described here in conjunction with menu item "Flue gas analysis"; never disconnect this connecting hose during a TSPM mass concentration measurement.

4.3.3 Particulate-matter sampling probe for TSPM mass concentration measurements

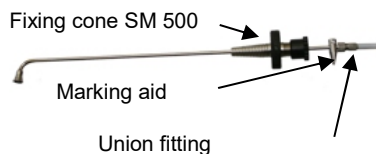

Fig. 14:
Particulate-matter sampling probe

To disconnect the particulate-matter sampling probe from the heating hose, simply undo the union fitting. It is also equipped with a fixing cone and a marking aid. This helps to align the probe correctly against the flow of flue gas when inserted in the intake orifice.

! ACHTUNG!

Always undo or close the union fitting with the hand, never with a tool.

4.4 Handling the heated intake hose

Handle the heated intake hose (Fig. 1, pos. 4) with extreme care to maintain its functional reliability over time. With this in mind, observe the following:

4.4.1 Hose bend radius



Fig. 15: Intake hose coiled around the reel

CAUTION!

Never bend the hose below the minimum hose bend radius of 180 mm.

Avoid kinking or twisting the heated intake hose at all times.

- To stow the intake hose in the case close the telescopic stand while carefully coiling the intake hose simultaneously around the reel (Fig. 1, pos. 22).

4.4.2 Attaching the intake hose to the control unit



Fig. 16: Attaching the heated intake hose to the digital mass scale unit

- Secure the heated intake hose to the rear of the control unit. To do so, insert it into the dedicated holder below the power supply connection for the hose heater.

This will avoid kinks to the hose and excessive vibrations.

4.4.3 Movements when measuring

- Do not touch or move the heated intake hose when taking measurements!



PLEASE NOTE!

If the full length of the heated intake hose is required to reach the measurement orifice, it is possible to forgo attaching the hose to the holder. In this case, ensure that the heated hose cannot move during measurements; for example, by securing it with adhesive tape.

5 TSPM mass concentration measurements

5.1 Planning measurements

- Plan the measurement process ensuring the temperature of the boiler water is at least 60 °C when measurements begin.
- When dealing with manually loaded systems, you should also ensure measurements can begin five minutes after the fuel has been added.



PLEASE NOTE!

This is possible when fuel is added after the hose heater reaches the target temperature of 75 °C. And that is the case when the first progress bar is completely green.

5.1.1 Measurement orifice

The measurement orifice should be located downstream of the last heat exchanger in the connecting flue pipe between the firing installation and the stack, where the flow is as undisturbed as possible. Make sure the measurement orifice is downstream of any flue gas cleaning equipment installed in the firing installation.

To disturb the flow as little as possible, the measurement orifice should be positioned in the connecting flue pipe at a distance equivalent to at least 2x, or better 5x, the diameter of the connecting flue pipe downstream of the flue gas outlet of the last heat exchanger or the flue gas cleaner. If an electrostatic precipitator is fitted, the measurement orifice must be located far enough away from the high voltage that the electric field has no negative influence on the sampling procedure.

Make sure there are no deposits of particulate matter on the measurement orifice. If necessary, use a brush to remove any deposits.



PLEASE NOTE!

Additional information is available in Appendix 1 and 2 of the 1st BImSchV of 26th January 2010 and ZIV recommendations (ZIV = German Central Guild Association of Chimney Sweeps).

5.1.2 Measurement phases

The TSPM mass concentration measurement using the Wöhler SM 500 consists of two phases:

1. To avoid condensation settling on surfaces exposed to flue gas, the heated intake hose and the digital mass scale unit are heated during the heating and stabilizing phase to a target temperature of approx. 75 °C. The duration of the heating process with subsequent stabilizing phase depends on the initial temperature. This generally takes approximately 12 minutes. Do not insert the particulate-matter sampling probe into the measurement orifice during this time.
2. The stabilizing phase is completed first before the user is prompted to insert the particulate-matter sampling probe into the measurement orifice and secure it in position against the direction of flow using the fixing cone.

**CAUTION!**

Due to the risk of electric shock, never operate the suspended particulate analyser close to water. Protect the analyser from moisture.

Always use the mains plug included in the scope of supply to connect the analyser to the mains power supply.

Route the power cable in a manner that ensures it is not subject to compression loads.

When handling, avoid kinking or twisting the heated intake hose at all times.

5.2 Switching on

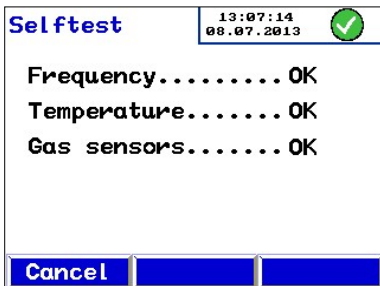

Fig. 17: Self-test

- Switch on the analyser using the On/Off switch (see Fig. 1, pos. 1).
The Wöhler SM 500 carries out a self-test immediately after it is switched on.



Fig. 18: HomeScreen

The home screen is displayed following a successful self-test.

**PLEASE NOTE!**

If a yellow warning light is displayed instead of a green OK button, check if there is a filter cartridge inserted, see chapter 8.2.

- Press start to initiate the measurement process.

5.3 Leak tightness test



Fig. 19: Leak tightness test

After inserting a new Wöhler filter cartridge, carry out a leak tightness test before performing measurements (see chapter 0). This test automatically checks all joints and connections of the Wöhler SM 500 for leaks.

- On the home screen press the "Start" button. The prompt "Close dust probe" is displayed.



Fig. 20: Sealing the probe

- Seal the probe orifice using your thumb and then press the "OK" button.

The automatic leak tightness test starts.

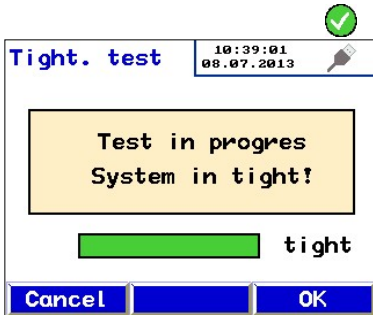

Fig. 21: Leak tightness test successful

- A green progress bar is displayed as the system is evacuated. The test is successful when the progress bar is complete. This procedure can take a few minutes. This program item is terminated after the leak tightness test is completed successfully.
- Then **slowly** release your thumb to ensure the Wöhler filter cartridge is not loaded.

! CAUTION!

If the leak tightness test is not successful, check all connections and seals beginning with the particulate-matter sampling probe through to the sample intake case.

Then repeat the test. The leak tightness test must be completed successfully before it is possible to carry out a TSPM mass concentration measurement.

- When the leak tightness test is finished press "OK" to access the list of permissible limit values.

5.4 Selecting a threshold value

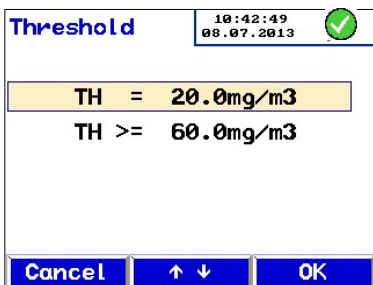

Fig. 22: Limit values available for selection

- Using the two middle arrow keys select the threshold value to be monitored, then press the "OK" button to confirm your selection.

PLEASE NOTE!

If the lower limit value 20 mg/m³ is monitored the volume flow rate is 4.5 l/min. If a limit value 60 mg/m³ or higher is monitored the volume flow rate is 3.0 l/min.

5.5 Stabilizing phase

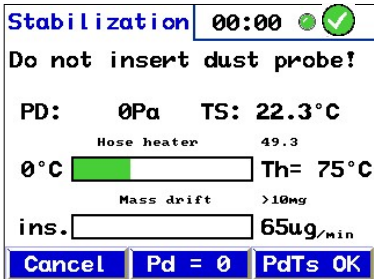

Fig. 23: Stabilizing phase of the digital mass scale unit

The stabilizing phase follows; during this time the digital mass scale unit and the heated intake hose are heated to operating temperature and the stabilizing criteria checked automatically. The display at this point is shown opposite.



PLEASE NOTE!

The "Hose heater" reading in the display indicates the deviation from the target temperature for the hose. "Mass drift" is a stability criterion.

This process sees the housing of the digital mass scale unit heated once. Depending on the initial temperature, this heating process lasts for approx. 1 minute.

The intake hose is heated continuously. The hose temperature sensor readings are indicated in the top green progress bar as shown in the graphic opposite. The hose should reach the required temperature of 75 °C within approx. 2-3 minutes.



PLEASE NOTE!

When working on a manually loaded system you can begin to add the fuel.

The bottom green progress bar indicates mass drift caused by the heating process.

Both progress bars are completely green after approx. 12 minutes. The Wöhler SM 500 then flags automatically that the particulate-matter sampling probe can now be inserted into the measurement orifice.



CAUTION!

Do not interrupt the stabilizing phase. If the "Cancel" button is pressed to abort the stabilizing phase at least 5 minutes must elapse before starting the next measurement.

Core flow search

It is possible to carry out a core flow search throughout the entire stabilizing phase, see chapter 4.3.1.

Press the "PdTs OK" button as soon as the core flow is located. The corresponding draft and flue gas temperatures are then captured. This is indicated in the display by a tick opposite the measurement readings.



PLEASE NOTE!

You can repeat the core flow search as often as required by pressing the "PdTs OK" button.

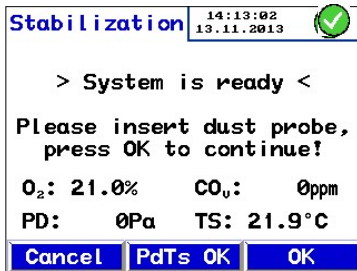

Fig. 24: Stabilizing phase completed

After the digital mass scale unit has been successfully stabilized, a prompt is displayed requesting you insert the probe.



PLEASE NOTE!

It is also possible at this point to determine the core flow; to do so, press the "PdTs OK" button.

- Insert the particulate-matter sampling probe into the measurement orifice; carefully secure the probe with the fixing cone, and then press "OK".



PLEASE NOTE!

A probe marker allows you to recognize the orientation of the probe orifice in the flue gas pipe.

Fig. 25: Particulate-matter sampling probe

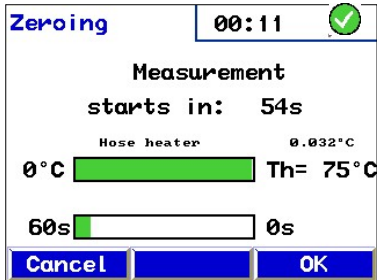

- There follows a zeroing phase lasting approx. 1 minute, during which time the initial mass of the filter cartridge is reset to zero.

The TSPM mass concentration measurement lasting 15 minutes then begins.

Fig. 26: Zeroing

5.6 Screens displayed during measurement

Graphic display:

Particulate matter mass collected in the filter cartridge

Function check

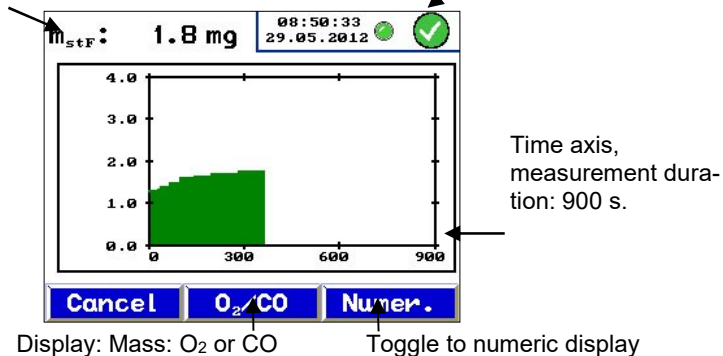

Fig. 27:

Graphic display during TSPM mass concentration measurement

Numeric display:

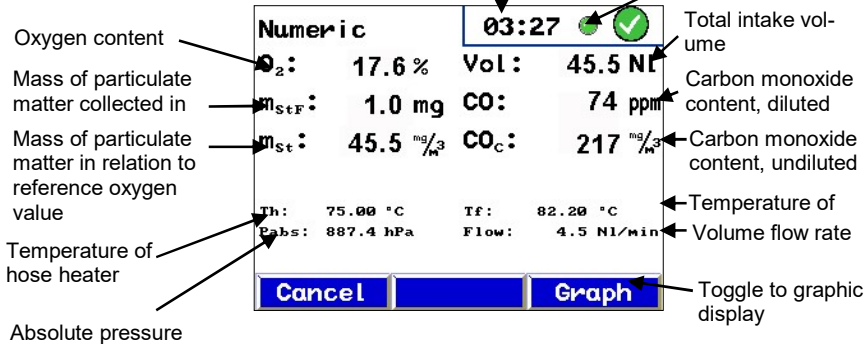

Fig. 28: Numeric display during the TSPM mass concentration measurement

TSPM mass concentration measurements

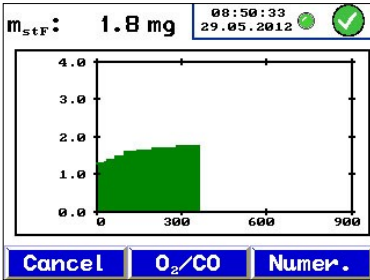

Fig. 29: Graphic display of filter loading with particulate matter

In the graphic display mode it is possible to toggle between three different measurement readings:

- Increasing filter loading with particulate matter (m_{PMF})
 - The current diluted CO_D content of the flue gas expressed in volume ppm (mean value over the measurement time)
 - The current flue gas oxygen concentration (mean value over the measurement time)
- To toggle between the three graphic displays press the middle button "O₂/CO".

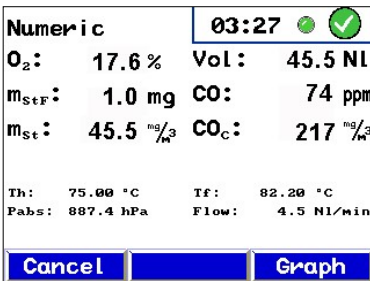

Fig. 30: Numeric display during the TSPM mass concentration measurement

- To switch to the numeric display of measurement readings from one of the graphic displays press the "Numer." button.



PLEASE NOTE!

Avoid using the "Cancel" button to terminate the measurement process. A new stabilizing phase is required before the measurement can begin again.

Warning „Filter“

If the pressure drop at the filter cartridge becomes too high during the measurement, a red warning "filter" will appear in the display.

In this case you can finish the running measurement. After the measurement it is absolutely necessary to change the Filter cartridge.



Fig. 31: Display immediately following the measurement

The prompt shown in the graphic opposite is displayed after the 15-minute measurement process has been completed.

- Remove the particulate-matter sampling probe from the measurement orifice.
- Press "OK" to display the measurement results.

5.7 Results display

The mean values are displayed in the results display screen throughout the entire measurement process. It is also possible to switch between the graphic and numeric displays. Press "PRINT" to printout the results on the Thermoprinter wöhler TD 100. It is also possible to print the results later by selecting the sub menu "Print results" (see 6.3) or the submenu "Print customer details" (see 6.4.3).

Res. 15:00		11:14:02 08.07.2013		
O₂:	17.6 %	Vol:	45.5 NL	
m_{stF}:	1.0 mg	CO:	74 ppm	
m_{st}:	45.5 $\frac{mg}{m^3}$	CO_c:	217 $\frac{mg}{m^3}$	
U:	16.4 $\frac{mg}{m^3}$	U:	265 $\frac{mg}{m^3}$	
m_{stU}:	0.029 $\frac{g}{m^3}$	CO_{CU}:	0 $\frac{g}{m^3}$	
Menu		Print		Graph

Fig. 32: Numeric display of the results of TSPM mass concentration measurement

Diagram key

O ₂	Oxygen concentration in volume %
m _{PMF}	Increase in filter loading with particulate matter mass expressed in mg
m _{PM}	Particulate matter concentration in relation to the reference oxygen content expressed in $\frac{mg}{m^3}$

U	Expanded uncertainty of measurement of particulate matter mass (left-hand column) and CO (right-hand column) expressed in mg/m ³
Vol	Sample intake volume
CO _D	Diluted carbon monoxide concentration CO _D expressed in ppm
CO _N	Carbon monoxide concentration CO _N expressed in mg/m ³ in relation to the reference oxygen content
<u>MPMU</u>	Final result - particulate matter mass: Mean value across the entire measurement time after allowance for the expanded uncertainty of measurement
<u>CO_{ND}</u>	Final result - carbon monoxide concentration: Mean value across the entire measurement time after allowance for the expanded uncertainty of measurement

5.8 Following every analysis

Proceed as follows after carrying out measurements:

- Close the measurement orifice.
- Purging is completed automatically after three minutes.



CAUTION!

It is necessary to purge the gas sensors to extend their service life.

- To save the measurement results under a customer name press buttons "Menu > Save", see chapter 6.4.
- Unscrew the screw cap (Fig. 1, pos. 9) and remove the filter cartridge (see chapter 0). (During the transport, no filter cartridge should be installed.)
- Carry out the cleaning steps as described in chapter 7.1 Maintenance list.

6 Menu

It is possible to configure various settings of significance for the analysis in the menu environment. Customer data are managed under the menu item Customer.

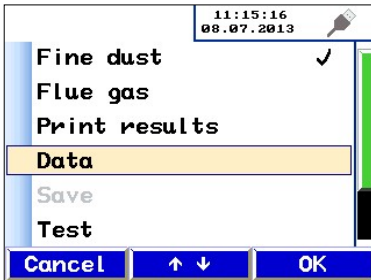

Fig. 33: Main menu, upper section of screen

- In the Home screen, press the "Menu" button.
- Use the middle arrow keys to move between the various menu items. Press "OK" to select the desired menu item.



PLEASE NOTE!

The menu item "Save" in the graphic opposite appears dimmed, and is unavailable for selection.

To save measurement readings, select an existing customer or create a new customer.

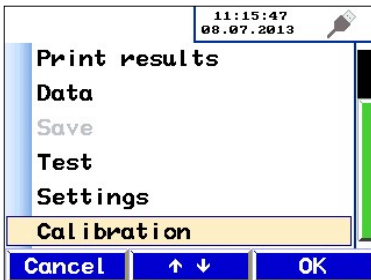

Fig. 34: Main menu, lower section of screen

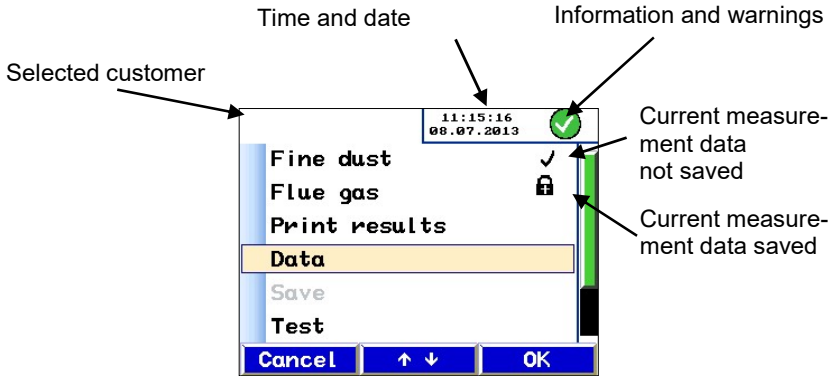

Fig. 35: Structure of the main menu

Information is provided opposite the menu items "TSP mass meas." and "Flue gas analysis" to indicate if current measurement results are available and if they have been saved:

- A tick opposite the menu item indicates that the measurement data is available, but has not been saved.
- A padlock opposite the menu item indicates that the measurement data has been assigned to a customer and saved.

6.1 Submenu "TSP mass meas."

In this submenu, it is possible to initialize a new TSPM mass concentration measurement. When beginning a new TSPM mass concentration measurement, all data not saved from a previous measurement will be lost. No further warning is issued.

6.2 Submenu "Flue gas analysis"

In this submenu, it is possible to make a preliminary or quick assessment of a heating system based on O_2 and CO concentrations.

- Remove the connecting hose "digital mass scale unit – condenser" from the condenser with a screwing motion (Fig. 1, pos. 16).
- Connect the gas connection of the probe and cable-hose assembly to the connection at the condenser inlet with a twisting motion (refer to the image opposite).
- In the main menu of the Wöhler SM 500, select the menu item "Flue gas".

A fresh air calibration is performed first.



PLEASE NOTE!

For this purpose, expose the probe to the surrounding air.



Probe and cable-hose assembly connection for flue gas analysis

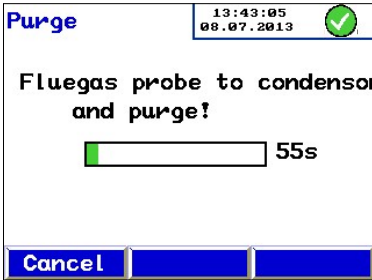

Fig. 36: Display during purging

The probe will now draw in fresh air for 60 seconds to purge the gas sensors. The process is represented by a green progress bar.

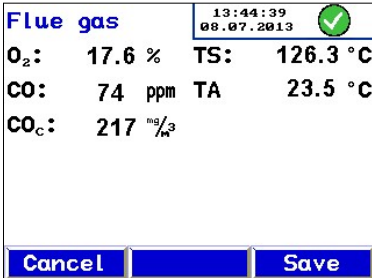

Fig. 37: Results of flue gas analysis

The latest measurement readings are displayed on completion.

- Now insert the gas probe into the flue gas. The results of the analysis are displayed online on the display.
- Press the "Save" button when the analysis is finished, meaning when the measurement readings have stabilized.

The results will be saved and the display changes to "Draft meas."

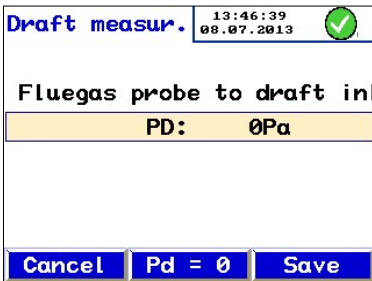

Fig. 38: Display of draft measurement

You will be prompted to reconnect the gas hose of the probe and cable-hose assembly.

Check the zero reference point during the draft measurement. To zero the differential pressure sensor, press the button PD = 0.



CAUTION!

Make sure there is no differential pressure at the measurement port when zeroing the sensor.



Fig. 39: Probe and cable-hose assembly connection for draft measurement

- Now attach the measurement hose of the Wöhler SM 500 probe and cable-hose assembly to the stack draft connector.
- The analyser will now determine the stack draft.
- Press the "Save" button to accept and save the draft reading PD and return to the menu.

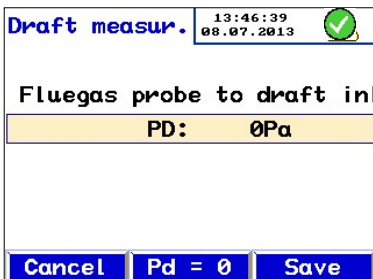

Fig. 40: Main menu following a flue gas analysis

In the main menu, a tick is displayed opposite the submenu "Flue gas analysis", because the current measurement readings for this item have been saved. If these data are saved under a customer name, then a padlock is displayed instead of a tick. The data are then stored permanently and can be retrieved again after the analyser has been switched off and on again, see chapter 6.5

6.3 Submenu "Print result"

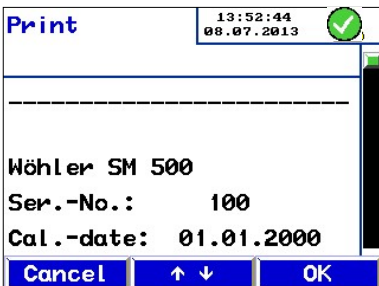

Fig. 41: On-screen preview of results printout

This menu item allows you to view the results of the last analysis or the results retrieved from the customer archive in the print preview screen, and then print them out on the thermal printer.

- Use the arrow keys to scroll through the displayed results.
- Press "OK" to print out the readings on the Wöhler TD 100 thermal printer.
- Press "Cancel" to return to the previous menu without printing out the readings.

Wöhler SM 500	
Ser.-No.:	1
Cal.date:	29/06/2012

Name :	Customer 1
Number :	1
System :	1

O2 Ref:	13.0 %
Fuel:
Meas. type:
. . .	
HC temp: °C

Flue gas analysis	
O2 :	17.6 %
COD :	0 ppm
CON :	173.6 ppm
CON :	217 mg/m ³
TFG :	126.3 °C
TA :	23.5 °C
PD :	-21.3 Pa

Vol :	45.5 Nl
Duration :	900 s

Mean value result:	
O2 :	17.6 %

COD :	74 ppm
CON :	217 ppm
U :	265 ppm
CONU :	0 mg/m ³

mPMF :	1.0 mg
mPM :	54.8 mg/m ³
U :	19.7 mg/m ³
mPMU :	31.5 g/m ³

Time analysis made:	
29/06/2012 13:56:38	

Certified technician	
.....	
.....	
.....	

Signature	

Example printout of results

The customer name and number, system designation, all measurement data as well as a field for the signature are displayed on-screen and printed on the printout. This means the printout can also serve as an analysis report for the customer.

The certified technician must fill out the fields "Fuel", "Meas. type" and "HC temperature" by hand.

 **PLEASE NOTE!**
Data is transmitted to the printer via an infrared interface located on the bottom of the control unit (Fig. 1, pos. 14). Make sure there are no obstructions between the infrared interface and the printer when data is being transmitted.

6.4 Submenu "Data"

The submenu "Data" is a dedicated environment for customer and measurement data administration.

- Use the middle arrow keys to move between the various menu items. Press "OK" to select the desired menu item.



Fig. 42: Customer administration

6.4.1 Customer

In this screen you can select an existing record.

- Use the middle arrow keys to select a record.
- Press "OK" to confirm your selection.

Customer data and the results of the last analysis are read in.



Fig. 43: Selecting a customer

6.4.2 New record

New record 13:59:11 08.07.2013 ✓

Name : Record 1

Number : 1

Aplian.: 1

← ↑ ↓ →

Fig. 44: Creating a new customer

In this screen you can create a new customer file.

- Select the subheading to be altered using the middle arrow keys
- Move to the corresponding subheading using the right arrow key "→". To alter the characters press the middle arrow keys. To return to the subheading selection option, press the left arrow key "←". The left arrow key "←" is replaced with "Next".
- Press "Next": Current customer data is displayed.

New record 14:04:55 08.07.2013 ⚠

Record
1
1

Continue?

Cancel OK

Fig. 45: Confirm new customer

- Press "OK" to confirm.

6.4.3 Print records

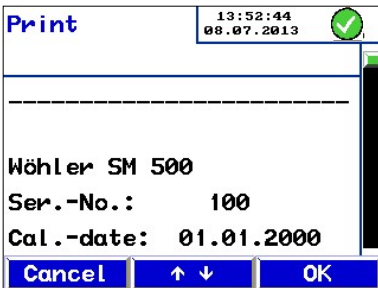

Fig. 46: Printing customer data and last analysis data

In this screen you can retrieve results stored under customer data and print these out, if required (see chapter 6.3).

- Scroll through the displayed screen using the middle arrow keys "↑↓".
- Press "OK" to print out the readings on the Wöhler TD 100 thermal printer.
- Press "Cancel" to return to the previous menu without printing out the readings.

6.4.4 Delete



Fig. 47: Selecting the customer to be deleted

In this screen you can select and delete a customer:

- Select the customer to be deleted using the arrow keys.
- To delete the customer, press the "OK" button.



Fig. 48: Deleting a customer

- Press "OK" to confirm your selection.

6.5 Submenu "Save"



Fig. 49: Saving measurement data

In this submenu you can save current measurement data. To do so, you must first select a record. For this purpose, the record must already exist (see submenu "New record", in chapter 6.4.2).

- Select the desired record, and press "OK" to confirm your selection.



PLEASE NOTE!

The new measurement results will overwrite any existing measurement readings stored under this customer name.

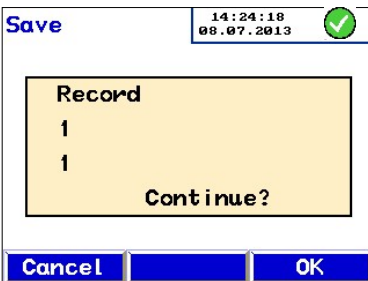

Fig. 50: Confirming saving measurement data

- To save current data and overwrite existing data, press the "OK" button.
- To exit the submenu without saving the data, press the "Cancel" button.

6.6 Submenu "Test"

The submenu "Test" is available to carry out the mandatory half-yearly check of the dominant measurands. In Germany, this inspection must be performed by a recognized body approved by the responsible authority in accordance with state law (1st BImSchV, §13). In accordance with VDI 4206 Part 2 the dominant measurands for TSPM mass concentration measurements are:

- The filter mass display
- The volume flow rate:
4.5 l/min for LV = 20 mg/m³
3.0 l/min for LV >= 60 mg/m³

Furthermore, the other measurands must be checked in accordance with VDI 4206 Part 1:

- Oxygen concentration in vol. %
- Carbon monoxide concentration in vol. ppm
- Temperature measurement
- Pressure measurement

In accordance with VDI 4206 Part 2 the dominant measurands must be within a tolerance of $\pm 5\%$.

The following articles must be made available for the functional test:

- Wöhler filter cartridge with known mass to check the digital mass scale unit
- A suitable volume flow rate meter to check the volume flow rates 4.5 l/min and 3.0 l/min
- Calibrating gases for O₂ and CO
- A suitable measuring test setup to check temperature measurements and pressure sensors

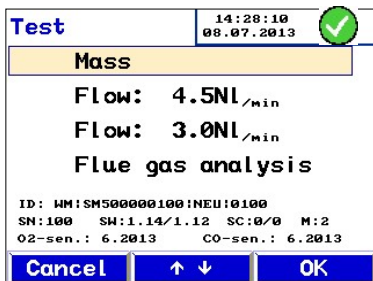

Fig. 51: Submenu "Test"

The screen opposite is displayed when the submenu "Inspection" is selected.

The following legend applies:

SN: Serial number

SW: Software version

SC: System counter

M: Number of measurements

O₂ sensor / CO sensor: Sensor data

In addition, the measurement readings to be checked are also displayed.

- Select the measurement readings to be checked using the arrow keys, then press "OK" to confirm your selection.

6.6.1 Mass

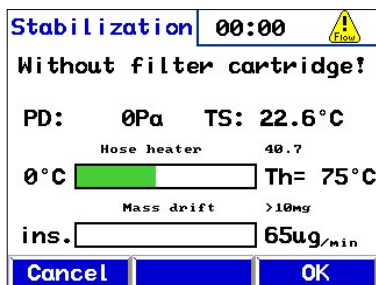

Fig. 52: Stabilizing the digital mass scale unit

The following selection is available:

This is where it is checked that the digital mass scale unit is functioning correctly.

The menu navigation is the same as for a normal TSPM mass concentration measurement (see chapter 5).

After selecting the submenu "Mass" you will be prompted to remove the filter cartridge.

- Remove the Wöhler filter cartridge and screw the screw cap back on (see chapter 0).



PLEASE NOTE!

Carry out these procedures only when the instrument has cooled down fully to the ambient temperature. Ensure the temperature remains as constant as possible.

- Weigh the filter cartridge on a laboratory precision balance, and write down the result.



PLEASE NOTE!

Ensure no filter cartridge is inserted when the instrument is in this test mode; this is indicated by the yellow warning triangle in the display.

In this case, the stability criterion "Mass drift" is used in the lower progress bar, as the pump, hoses and the probe heater are not activated. It takes at least 3 minutes to fill the progress bar.

- Press "Next" when the mass drift progress bar is filled completely green to initiate the zeroing process.

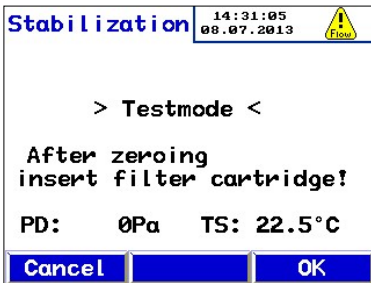

When zeroing has been completed you are prompted to re-insert the filter cartridge – after zeroing!

- Press "OK".

Fig. 53: Zeroing during the "Mass" check

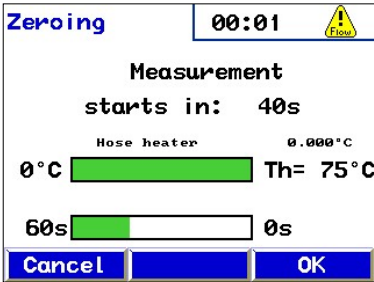

Fig. 54: Zeroing

- When the lower progress bar is full after approx. one minute, the graphic displaying the measurement readings is displayed.

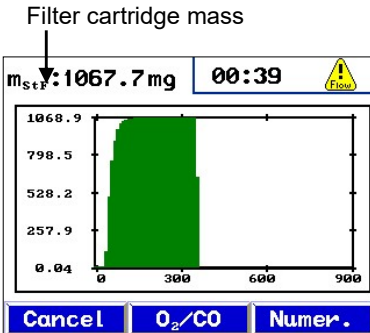

Fig. 55: Graphic display when measuring the filter cartridge mass

- Undo the screw cap, insert the weighed filter cartridge, and then screw the cap back on again (see chapter 0).

It takes at least 2 minutes before the measurement reading can be read and compared with the target mass of the weighed filter cartridge. The maximum deviation from the target mass must not exceed $\pm 5\%$.



CAUTION!

Do not move the digital mass scale unit or operate the keys after inserting the filter to avoid possible measurement errors resulting from associated vibration.

For report purposes this measurement reading is also included on the printout under "Menu" > "Print result"; it can also be saved under a customer name.

6.6.2 Vol_F: 4.5 NL/min and vol_F: 3.0 NL/min

After you select the required volume flow rate and press "Next" to confirm your selection, the pump is started and regulated to draw in the selected volume flow rate.

! CAUTION!

Before the Inspection is performed, it is imperative to carry out a leak tightness test to ensure the instrument is leak tight (see chapter 5.3).

Perform the test on the sampling probe.

The maximum deviation from the target value must not exceed $\pm 5\%$.

No changes occur to the on-screen display.

To halt the pump, select and confirm a different subheading or press "Next".

6.6.3 Flue gas analysis

Proceed as follows to check the gas sensors with calibration gas:

- First connect the probe and cable-hose assembly as described under subheading 4.3.3.



Fig. 56: Probe and cable-hose assembly connection for flue gas analysis



Fig. 57: Fresh air calibration

The pump starts when the test subheading "Flue gas analysis" is selected; however, the volume flow rate is reduced in comparison with a normal flue gas analysis.

A fresh air calibration phase is started for 60 s.



PLEASE NOTE!

The flow is reduced during the test to ensure calibration gas is not used unnecessarily.

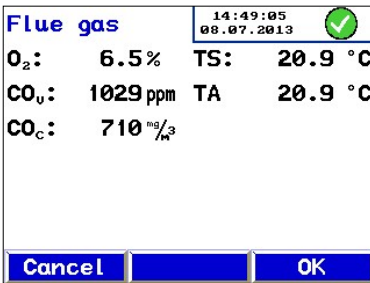

Fig. 58: Calibration measurement reading in display

The display then automatically switches to the measurement view.

- Now allow the calibration gases to flow into the Wöhler SM 500 probe and hose assembly. It is possible to read off the reference values during the measurement.

Permissible deviations are described in Annex B of the guideline VDI 4208 Part 2.

For report purposes this measurement value is also included on the printout under "Menu" > "Print result"; it can also be saved under a customer name.

- To accept and save the values, press the "Save" button.



Fig. 59: Stack differential pressure display

The display switches to draft measurement. The sequence is identical to the draft measurement described under the subheading "Menu" > "Flue gas analysis" (see chapter 6.2).



Fig. 60: Probe and cable-hose assembly connections for draft measurements

- Now attach the measurement hose of the Wöhler SM 500 probe and cable-hose assembly to the stack draft connector.

- Check the zero reference point during the draft measurement. To zero the differential pressure sensor, press the **P_D=0** button.

! CAUTION!

Make sure there is no differential pressure at the measurement port when zeroing the sensor.

For report purposes this measurement value is also included on the printout under "Menu" > "Print result"; it can also be saved under a customer name.

A measurement should be started to conclude the half-yearly inspection. The message "STABLE" should appear after 15 minutes at the latest. Carry out this test at the end of the inspection, because the hose and digital mass scale module heaters have already been activated.

6.7 Submenu "Settings"

Settings	
	14:39:34 08.07.2013 
Date	: 08.07.2013
Time	: 14:39:16
O2ref.	: 13.0%
Mass-U	: 40.0%
CO-U	: 20.0%
<div style="display: flex; justify-content: space-between; align-items: center;"> Cancel ↑ ↓ → </div>	

Fig. 61: Setting important parameters

Proceed as follows to alter settings:

- Use the arrow keys "↑↓" to select the parameter you wish to alter.
- Using the right arrow key "→" select the numerical value you wish to alter. Use the middle arrow keys "↑↓" to increase or lower the value. The "Next" button is replaced by the left arrow key "←" to facilitate selecting the corresponding digit. You can also use it to return to the parameter selection screen.
- Then press the "Next" button followed by the "OK" button to confirm the new setting.

The following parameters are available:

Date and time

Correct date and time settings are particularly important for the analysis report printout.

O2ref (13.0 %)

Reference oxygen value entry

U_{PM} (40%)

Expanded uncertainty of measurement for particulate matter

CO-U (20 %)

Expanded uncertainty of measurement for CO



CAUTION!

The uncertainty values (-U) are set due to German federal requirements. Set these values to 0% if you do not perform measurements according to the German regulation BImSchV.

6.8 Submenu "Calibration"



CAUTION!

Authorized service personnel only are permitted to make settings in this menu! Unsuitable changes to these settings can lead to erroneous analysis results.

A code is used to prevent users accessing this menu item, because the volume flow, gas sensors and the temperature sensors are calibrated in this menu.

The data from the last Inspection is also reset in this menu. The access code must be made available to the approved body for this purpose. When exiting the calibration mode, a message is displayed asking if the date of the last calibration/inspection should be updated.

7 Maintenance

To guarantee the Wöhler SM 500 analyser functions flawlessly, it must be maintained on a regular basis. Maintenance includes actions that the user can carry out himself. In addition, the analyser must be inspected on a half-yearly basis by an approved body recognized by the responsible authority in accordance with (German) state law to ensure compliance with minimum legal requirements. The corresponding inspection process is described in chapter 6.6.

**CAUTION!**

Always ensure the analyser is switched off before commencing maintenance work, apart from when cleaning the sample intake hose.

**CAUTION!**

Do not use or allow the analyser to come into contact with harsh or abrasive cleaning agents when carrying out maintenance work, because they can impair the operational reliability of the analyser.

7.1 Inspection and maintenance list

Interval	Maintenance task
Following every analysis	Check the filter cartridge, replace if necessary.
	Inspect the flue gas condenser, empty condensate if necessary.
	Check fleece filter in the flue gas condenser for presence of moisture and contamination, replace if necessary.
	Check cotton filter in the case in front of the pump for moisture and contamination, replace if necessary.
At the end of each day of analysis	Clean the heated sample intake hose using a long, fine hose brush and air puffer.
	Clean the digital mass scale unit using a short, fine hose brush and air puffer.
After approx. 25 analyses - and after one month at the latest	Check the hose temperature sensors, and clean if necessary
1/2 yearly	In Germany, inspection and calibration are undertaken by a recognized body approved by the responsible authority in accordance with state law (1st BImSchV, §13).

7.2 Emptying condensate and replacing the fleece filter



Fig. 62: Close-up view of the flue gas condenser

Diagram key

1 Fleece filter holder

2 Condenser holders

The user is responsible for emptying the condensate, which collects regularly in the condensate trap. The fleece filter must also be replaced regularly. To do so, proceed as follows:

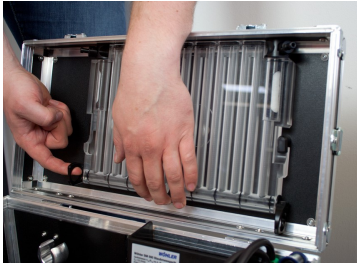

Fig. 63: Removing the flue gas condenser

- Close the telescopic stand to make it easier to access the flue gas condenser.
- Remove the hoses from the condenser connected to the digital mass scale unit (Fig. 1, pos. 16) and the case (Fig. 1, pos. 18).
- Turn both condenser holders upwards. The condensate will now flow into the condenser holder (1).
- Remove the flue gas condenser from the lid of the case.

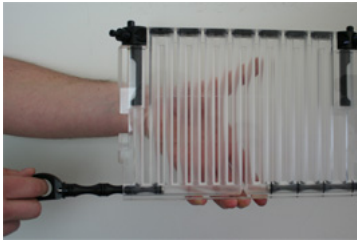
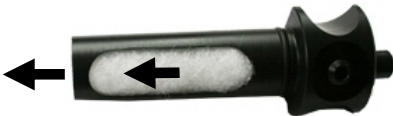

Fig. 64: Removing a sealing plug of the condensate trap

- Remove the two sealing plugs of the condensate trap.
- Empty the condensate.
- Push the sealing plugs into their original position again and lock them by pushing the lever to the front.



Condensate filter holder with fleece filter

- Check the fleece filter regularly to see if it is wet or contaminated, and replace if necessary.
- Pull the condensate filter holder (3) out of the flue gas condenser.
- Remove and replace the filter fleece from the filter holder (see Accessories).
- Refit the filter holder in the flue gas condenser.



Fig. 65: Refitting the condenser

- Refit the condenser in the lid of the case.
- Fold down the condenser holders one after the other. Meanwhile support the condenser with the other hand.
- Reconnect the hoses (Fig. 1, pos. 16 and 18).

7.3 Replacing the cotton filter in the case

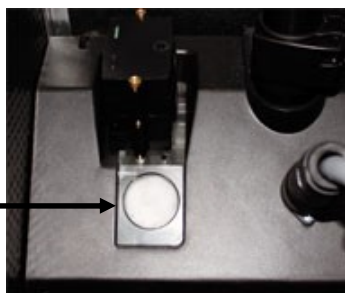

Fig. 66: Cotton filter in the case

- The cotton filter in the case is located below the connecting hose flue gas condenser - case (Fig. 1, pos. 19).
- Detach the hose connector after each and every flue gas analysis, and check the cotton filter for moisture and contamination.
- If necessary, remove and replace the cotton filter (see Accessories).

7.4 Cleaning the heated intake hose

After every work day with several measurements, after every measurement $> 100 \text{ mg/m}^3$ and after every measurement with the combustible "coal" the heated intake hose and the sampling probe must be cleaned. Cleaning will take only a few minutes.

Removing the sampling probe

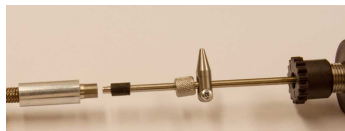

Fig. 67: Sampling probe removed from the intake hose

- When the device is switched off, loosen the union fitting and disconnect it from the hose.



ATTENTION!

Always undo or close the union fitting with the hand, never with a tool.

The intake hose stays connected to the digital mass scale unit.

Cleaning the intake hose



Fig. 68: Inserting a used filter cartridge



Fig. 69: Ignore the prompt to close the dust probe

Clean the heated sample intake hose at the end of every working day that has included several analyses. To do so, proceed as follows:

- Insert the filter cartridge into the analyser (see chapter 0). This can be a used filter cartridge.

HINWEIS!

It is important that a filter cartridge is inserted when cleaning the intake hose, because the cartridge must collect the pollution.

It is possible to insert a used filter cartridge.

- Switch on the Wöhler SM 500.
- On the Home Screen, press "Start"
- Ignore the prompt to close the dust probe.
- Press OK.
- The Wöhler SM 500 is in the mode "Tightness test".

ATTENTION!

It is very important to clean the hose in the "tightness test"-mode with the pump working, so that loosened particles can be sucked. Never clean the intake hose during the stabilization phase or in the measuring mode or when the device is switched off.

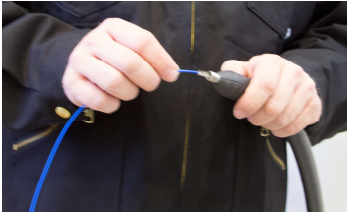

Fig. 70: Cleaning the intake hose

- When the pump is running, clean the heated sample intake hose with the long, fine Wöhler SM 500 cleaning brush, see Accessories.
- Switch off the Wöhler SM 500 afterwards.



Fig 71: Pushing the cleaning brush into the heated sample intake hose



ACHTUNG!

Push the cleaning brush into the hose up to the green pad, in no case further!

Cleaning the particulate-matter sampling probe

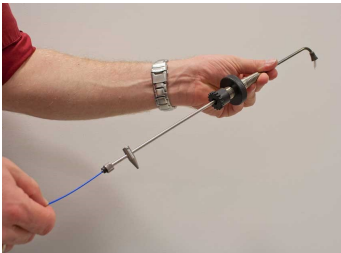

Fig. 72: Cleaning the sampling probe with the long cleaning brush

- Now clean the sampling probe as follows:
- Push the long cleaning brush (see accessories) through the probe from the thread to the opening and pull it back again.

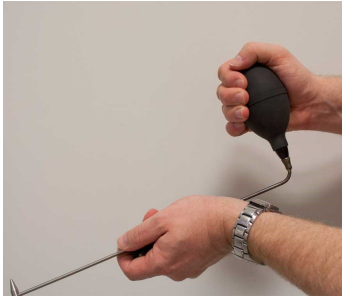

Fig. 73: Cleaning the sampling probe

- With the Air Puffer (see accessories) blow the dislodged particles out of the sampling probe.

Connecting the particulate-matter sampling probe to the heating hose



Fig. 74: Rubber seal at the end of the sampling probe

Connect the particulate-matter sampling probe to the heating hose as follows:

1. Push the rubber seal to the end of the sampling probe.

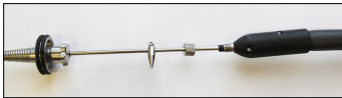

Fig. 75: Rubber seal inserted into the end piece of the heating hose

2. Insert the rubber seal into the end piece of the heating hose and after that push the sampling probe until you feel a resistance.



Fig. 71: Particulate-matter sampling probe connected to the heating hose

3. Close the union fitting with the hand.



ATTENTION!

Never use a tool to undo or close the union fitting!

Removing the filter cartridge



- Tilt the control unit (12) to one side.
- Unscrew the screw cap (9) of the digital mass scale unit.

The filter cartridge is now exposed.

- Carefully withdraw the filter cartridge.

Fig. 77: Removing the filter cartridge

7.5 Cleaning the digital mass scale unit



Fig. 78: Filter holder and filter cartridge

The sample infeed tube leading to the filter holder of the Wöhler filter cartridge is extremely thin and, consequently, extremely susceptible to damage. Located in the digital mass scale unit it is possible to see inside the tube when the Wöhler filter cartridge is removed.

- Carefully clean the tube using the fine Wöhler SM 500 cleaning brush.
- Clean the inside only of the sample infeed tube leading to the filter holder with the brush.

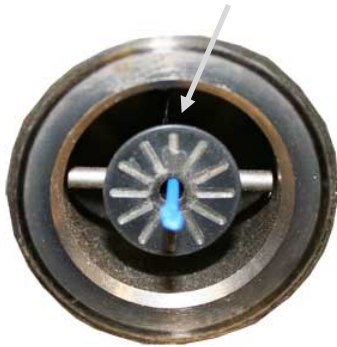

Fig. 79: Sample infeed tube to filter holder with cleaning brush. The arrow marks the position of the thermocouple

! CAUTION!

When inserting the cleaning brush take care that the pad stays completely outside the tube (see figure on the left.)

! CAUTION!

Work with extreme care, and ensure you do not damage the slender thermocouple. It is not necessary or approved to clean the area surrounding the filter holder.

In the figure on the left the arrow marks the position of the thermocouple.



Fig. 80: Air puffer, long and short fine cleaning brushes

- Visually inspect to ensure there are no metal chips sticking to the magnets. If there are, remove them using the Wöhler SM 500 air puffer (see Accessories).

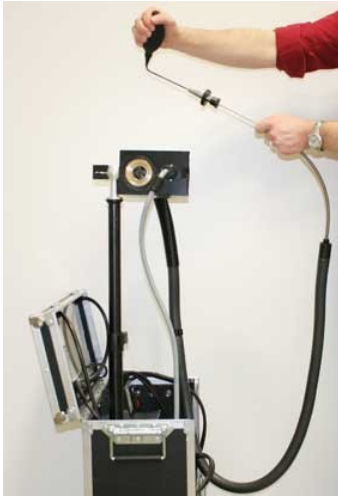

Fig. 72: Purging the sampling probe, the hose and the digital mass scale unit

- With the air puffer (see accessories) , purge the probe, the hose and the digital mass scale unit, to blow away the particles that the cleaning brush has pushed into the cartridge support.

7.6 Checking the hose temperature sensor, clean if necessary



Fig. 82: Releasing and twisting the connector plug

- Separate the hose connection cable from the probe by releasing and twisting the connector plug.



Fig. 83: Removing the connector plug



Fig. 84: Disconnecting the heated sample intake hose

To clean the hose temperature sensor, it is necessary to separate the heated sample intake hose from the probe. To do so, proceed as follows:

- Carefully turning the hose cap (1) pull it back together with the hose.
- Twist off the black-colored union nut (2)



Fig. 85: Hose temperature sensor

- Remove the hose from the digital mass scale unit.
- Carefully remove the hose temperature sensor from the fixture.

- Carefully clean the temperature sensor using the short, fine cleaning brush (see Accessories). Insert the brush and clean the digital mass scale unit. If you encounter heavy tar deposits, use a pipe cleaner dipped in acetone.



CAUTION!

Avoid bending the sensor under all circumstances.

- Do not insert a filter cartridge just yet.



PLEASE NOTE!

To reassemble, proceed in the reverse order.

- Carefully refit the temperature sensor.

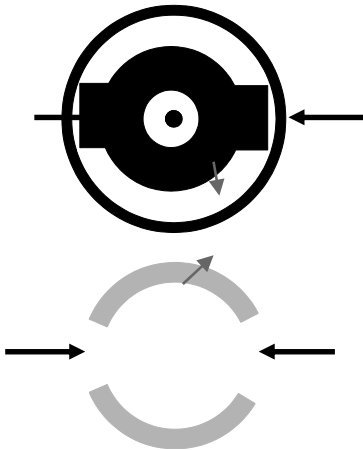

Fig. 73: Top: Inside of hose connector
Below: Hose connector on the control unit

- Screw the heated hose back onto the control unit.



PLEASE NOTE!

Make sure both lugs inside the hose connector are positioned precisely into the mating recesses in the thread above the temperature sensor. Otherwise, it is not possible to achieve a properly sealed connection.

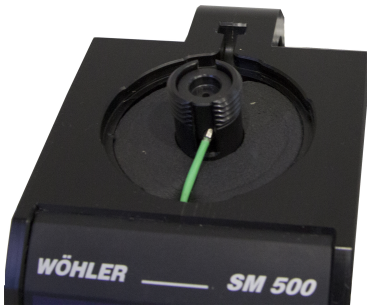

Fig. 87: Hose connector on the control unit



- Carefully refit the connector plug. To do so, insert the plug with a twisting motion.
- Turn the connector to the right to its final position until it locks with an audible click.

Fig. 88: Inserting the connector plug



Fig. 89: Indentation for the connection cable of the heated sample intake hose



Fig. 90: Connection cable of the heated sample intake hose routed according to best practice

- Feed the connection cable of the heated intake hose through the notch provided (see images opposite and below).

- Finally, put the cap of the heated intake hose back on again.

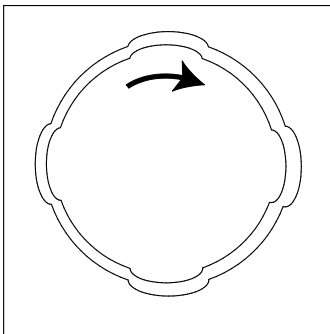

Fig. 91: Refitting the hose cap back onto the control unit



PLEASE NOTE!

The cap of the heated sample intake hose has four outward facing bulges corresponding to the recesses on the top part of the control unit.

- Place the cap onto the control unit ensuring the bulges and recesses match one another; then twist the cap so that it is joined securely to the control unit.

- Carry out a leak tightness test.

7.7 Sensor Replacement

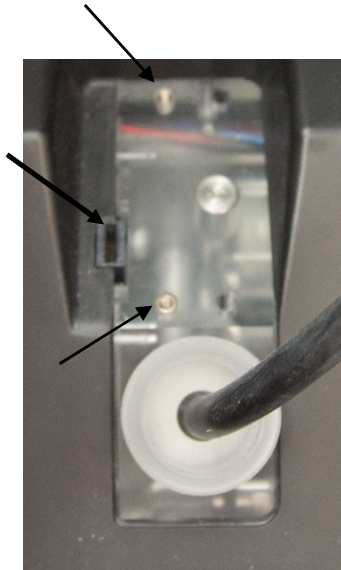

Fig. 92: Position of the sensor module with slot for the pinboard and threads for the screws.

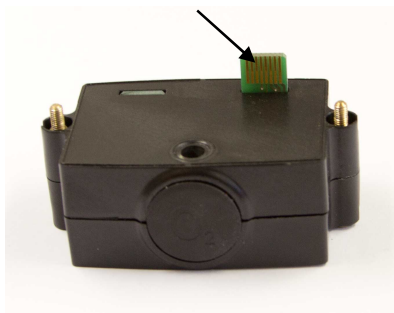

Fig. 93: Sensor module with pinboard

- If the fault indication shown on the left appears, the gas sensor will be damaged. In this case change the O₂ or CO sensor (0, part 28).



Warning!

Before changing a sensor ensure that the device is switched off!



Note

The upper module is the CO module, and the lower one is the O₂ module.

- Use a screwdriver to unlock the upper sensor by removing the two screws.
 - Remove the upper CO module.
 - Proceed as described before with the lower module, if you also want to change the O₂ module.
-
- Install the new sensor module by plugging the pinboard exactly into the slot and fix the screws hand-tight.



Condensate trap module installed between gas path and O₂ sensor

As an option, a condensate trap module can be installed between gas path and O₂ sensor.

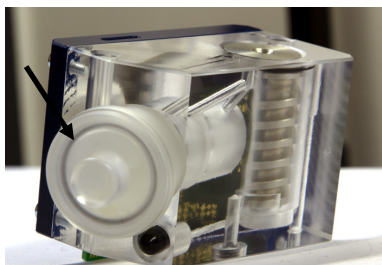

Condensate trap module and container for silica gel beads

- We recommend you replace the silica gel beads in the condensate trap module following each measurement. To do so proceed as follows:
- Pull container with the silica gel beads out of the module.



NOTE!

Hold the container for silica gel beads below the lid. If you grasp the lid to pull out the container, it may open and the silica gel beads will fall out.



Container for beads opened

- Pull off the lid.
- Pour the silica gel beads into a plastic bag; dispose of them in accordance with local authority guidelines.
- Fill the container with new silica gel beads.
- Close the lid and replace the container containing the silica gel beads back into the condensate trap module.

8 Control functions / faults

8.1 Self-test

The analyser carries out a self-test immediately after it is switched on. OK indicates the self-test was successful. The following tests are performed:

- Self-test frequency: Checks if the digital mass scale unit is functioning. If an error message is displayed, check if the Wöhler filter cartridge has been inserted correctly.
- Self-test temperature: Checks if the precision temperature measurement system is functioning correctly.
- Self-test gas sensors: Checks if the O₂ and CO flue gas analysis sensors are functioning correctly.

8.2 Control functions

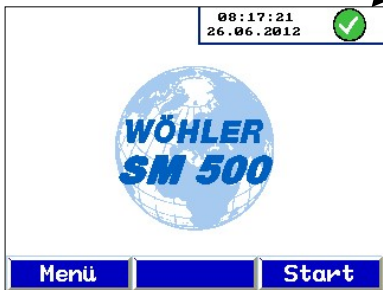



Fig. 94: Home Screen

A symbol in the top right of the screen indicates at all times whether the analyser is operating flawlessly or if a fault has occurred.





The following information and warnings are possible:

Information	Meaning
 USB connection to the computer	The Wöhler SM 500 is connected to a Computer via USB.
 All OK.	The Wöhler SM 500 is operational.

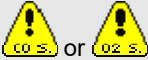

ATTENTION!

Send the analyser for servicing if the error messages continue to occur after carrying out the measures described above..

Fault indication	Possible cause	Remedy
 Gas sensors not functioning	Gas sensors could not be detected	Check connections of gas sensors
 Gas sensors defective	Communication error between digital mass scale unit and case	Turn analyser off and on again
 Frequency error - digital mass scale unit	Frequency of digital mass scale unit too high	<ul style="list-style-type: none"> - Check if the filter cartridge is seated correctly
	Measurement error	<ul style="list-style-type: none"> - Turn analyser off and on again - Check connection cable between digital mass scale unit and case, replace if necessary
 Volume flow not in required range	Digital mass scale unit defective	Send analyser for repair
	Fleece or cotton filter damp or contaminated	<ul style="list-style-type: none"> - Check fleece and cotton filters, replace if necessary - Empty condensate out of condenser
	Particulate matter loading in filter cartridge too high	Replace filter cartridge with a new one; repeat analysis, if necessary
	Communication error between digital mass scale unit and case	<ul style="list-style-type: none"> - Turn analyser off and on again - Check connection cable between digital mass scale unit and case, replace if necessary
	Reduce the flow during the test and calibration procedure to ensure calibration gas is not used unnecessarily. The warning symbol is displayed here for that reason	<ul style="list-style-type: none"> - No measures required
 Temperatur warnung	Analyser defective	Send analyser for repair
	Hose temperature sensor polluted	Clean hose temperature sensor, see point 7.6.
	Hose temperature sensor defective	Send analyser for repair

 Filter temperature warning	Temperature of the SM 500 < 0° C or temperature sensor defective	Before measuring make sure that the analyzer is warmer than 0°C.
Red text "Filter"	Pressure drop at the filter cartridge is too high	Finish the running measurement and change the filter cartridge after that.
Negative result	The dust probe is too cold	Preheat the probe, e.g. with the heatable probe support

9 Warranty and Service

9.1 Warranty

Each Suspended Particulate Analyser Wöhler SM 500 will be tested in all functions and will leave our factory only after extensive quality control testing. The final control will be recorded in detail in a test report and delivered with any unit.

If used properly, the warranty period for the Wohler SM 500 will be 12 month from the date of sale. Not covered by the warranty are components subject to wear, e.g. filters.

This guarantee does not include the costs for transport and packing material in case of repair.

Service by non authorized personnel or making modifications to the Analyser voids any warranty.

9.2 Service

We see SERVICE as a very important element in our business. That is why we are still available to you even after the guarantee period has expired.

- An immediate repair will be carried out if you bring your instrument to us in Bad Wünnenberg.
- If you send us the instrument, it will be returned to you by our delivery service after repair in just a few days..
- You can obtain immediate help from our engineers by telephone.

10 EC Conformity

The manufacturer

WÖHLER Technik GmbH
Wöhler-Platz 1, D-33181 Bad Wünnenberg

declares that the product:

Product name: Wöhler SM 500 Suspended Particulate Analyser
corresponds to the following product specifications:

TÜV test to 1st BImSchV and KÜO, TÜV By RgG 290
(BImSchV = Federal Immission Control Act
KÜO = Ordinance regulating the sweeping and inspection of chimneys
TÜV By RgG 290 =
VDI 4206, Part 2
EN 50270 and EN 61000-6-3

Further information:

The analyser complies with the essential requirements of the following directives: Directive 2014/30/EC on EMC and the Low Voltage Directive 2014/35/EC (EN 60 74 29 / 95). When using the analyser observe the following information pertaining to the operating instructions:

CE Mark on the Wöhler SM 500 - Information on EMC Declaration of Conformity in the operating instructions

The electromagnetic disturbance produced by this analyser is well below the legal limit.

Bad Wünnenberg, 09.08.2022



Dr. Stephan Ester, Geschäftsführer/Managing Director

11 Accessories

Printer

Wöhler TD 100 Thermal Printer Order no. 4160

Spare parts and consumables

10 Filter Cartridges for Wöhler SM 500 in exchange of used cartridges Order no. 8917

10 Filter Cartridges for Wöhler SM 500 Order no. 8916

Coarse filter vlies for Wöhler SM 500 Order no. 9503

Wadding Filters for Wöhler SM 500 Order no. 6052

Maintenance accessories

A set of 3 fine Wöhler SM 500 cleaning brushes for use on measurement hose and digital mass scale unit Order No.: 8909

Wöhler SM 500 air puffer Order No.: 8918

Software

Wöhler SM 500 PC software incl. USB cable Order No.: 8914

Shipping

Wöhler SM 500 backpack carry case Order No.: 8911

Additional telescopic stand

Stand set including stand, extension control cable and sample intake hose to set up the control unit outside of the case. Order No.: 8919

Heat able support for the sampling probe Order No.: 8921

Extras

Condensate trap module Wöhler SM 500 Order-No. 4299

Refill package silica gel Order-No. 9522

Probe tube 450 mm, straight for Wöhler SM 500 Order-No. 8946

Additional Probe Heating Wöhler SM 500 Order-No.. 23201

Points of sale and service

Germany

Wöhler Technik GmbH

Wöhler-Platz 1
33181 Bad Wünnenberg
Tel.: +49 2953 73-100
Fax: +49 2953 73-96100
info@woehler.de
www.woehler.de

Wöhler West

Steiger-Stein-Str. 5
44805 Bochum
Tel.: +49 234 516993-0
Fax: +49 234 516993-99
west@woehler.de

Wöhler Süd

Gneisenastr.12
80992 München
Tel.: +49 89 1589223-0
Fax: +49 89 1589223-99
sued@woehler.de

USA

Wohler USA Inc.
208 S Main Street
Middleton, MA 01949
Tel.: +1 978 750 9876
www.wohlerusa.com

Czech Republic

Wöhler Bohemia s.r.o.
Za Naspem 1993
393 01 Pelhrimov
Tel.: +420 565 323 076
Fax: +420 565 323 078
info@woehler.cz

Italy

Wöhler Italia srl
Via Coraine 21
37010 Costermano VR
Tel. +39 045 6200080
Fax. +39 045 6201508
www.woehler.it

France

Wöhler France SARL
17 A impasse de Grousset
31590 Lavalette
Tel.: +33 5 61 52 40 39
Fax: +33 5 62 27 11 31
info@woehler.fr
www.woehler.fr

Austria

Wöhler GmbH
Heinrich-Schneidmadl-Str. 15
3100 St. Pölten
Tel.: +43 2742 90855-11
Fax: +43 2742 90855-22
info@woehler.de

Your contact: