

**Camera Body with
Sun Shield Attached**

1 Check Contents

The camera kit includes a bag containing:

- a T10 Torx wrench
- two 10-pin connectors for I/O terminal blocks
- one three-pin connector for 12 VDC terminal block
- three two-pin connectors for 24 VAC output / input terminal blocks

In addition, watertight cable glands and seal plugs are attached to the camera's rear cable ingress holes.

If any of these items are missing or damaged, contact your dealer or [Teledyne FLIR Support](#).

Caution

- Teledyne FLIR recommends only trained personnel install the camera.
- Before installing an FH-Series camera, Teledyne FLIR recommends reading and understanding the *FH-Series Installation and User Guide* (427-0102-00-10). To download the guide, scan the QR code at right.
- Except as described in these guides, do not open an FH-Series camera or attempt to disassemble it. Attempting to disassemble the camera can cause permanent damage and voids the warranty.
- Electrostatic discharge (ESD) or careless handling can cause damage to the camera. To avoid damaging electrostatic-sensitive components, always handle the camera with care.
- Be careful not to leave fingerprints on the FH-Series camera's infrared optics.



2 Select a Location

FH-Series cameras are intended to be mounted on a medium-duty fixed pedestal mount or wall mount commonly used in the CCTV industry, at an installation height of at least 4 m (13 ft). The mount must support up to 30 lbs (15 kg). For the full list of mounting and other accessories available for the camera from Teledyne FLIR, see the *FLIR Security - Accessory Guide*.

If you are powering the camera with PoE 70W class 8 or 24V AC / DC, verify that the operating temperature is -40°C to 70°C (-40°F to 158°F) with cold start at -40°C (-40°F), 0-95% relative humidity. Other power sources limit low-temperature operation.

Supplying Power to the Camera

The camera can be powered by 12 VDC ($\pm 10\%$); 24 VDC ($\pm 10\%$); 24 VAC ($\pm 10\%$); or PoE IEEE 802.3bt 50W class 6 or 70W class 8. Teledyne FLIR recommends using PoE class 8 or 24 VAC / VDC.

Nominal power consumption is 15W; 48W on 12 VDC with heaters enabled; and 70W on all other input voltages with heaters enabled.

Warning

- Operating the camera outside the specified input voltage range or outside the specified operating temperature range can cause permanent damage.
- Failure to properly ground the camera can cause permanent damage. Make sure the camera is properly grounded.
- At the mounting location, secure the camera before supplying power to it.
- The camera itself does not have a power on/off switch. Do not supply power to the camera until you have completely finished connecting it.

3 Connect the Camera

Teledyne FLIR recommends connecting the camera on a bench or in a lab and configuring it for networking before mounting and aiming it. However, circumstances can dictate mounting the camera before connecting it and configuring it for networking. Adjust these steps accordingly.

Side Panel Interfaces

A microSD card slot and a reset / default button are on a panel on the side of the camera, behind an access cover .

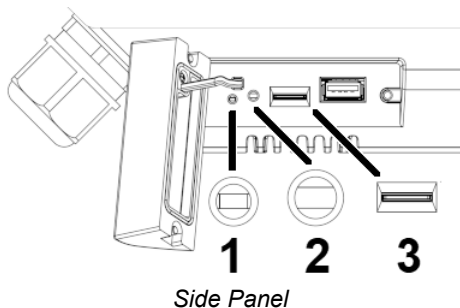
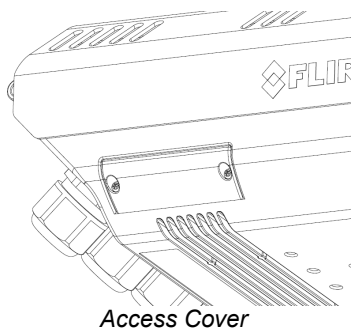

Side Panel	
1	LED status indicator —Solid green indicates the camera is powered and operating.
2	<p>Recessed Default / Reset button—To press the button, Teledyne FLIR recommends using a cell phone SIM or memory card tray eject tool or something similar.</p> <ul style="list-style-type: none"> To reboot and reset the camera to its previously saved settings, press the button for between 1-3 seconds. To reboot and reset the camera to its factory default settings, press the button for at least 10 seconds.
3	microSD card slot
The USB port is reserved for future use.	

- Loosen and remove the screws that secure the access cover.
- Insert a microSD card into the slot.



Important

Use a preformatted microSD card or format it with a single partition using the camera's web page or a PC. For more information, see the camera's installation and user guide.



Tip

Access the camera's web page, open the Recording page, and make sure the camera recognizes the microSD card.

- To ensure that the camera remains waterproof, store the access cover anti-drop strap inside the camera.
- Close and lock the access cover.

Primary Connections

- Through slots in the sunshield, use the Torx wrench supplied with the camera to loosen and remove the two screws that secure the camera's top cover and that are closest to the hinges. Then, loosen and remove the other two screws.

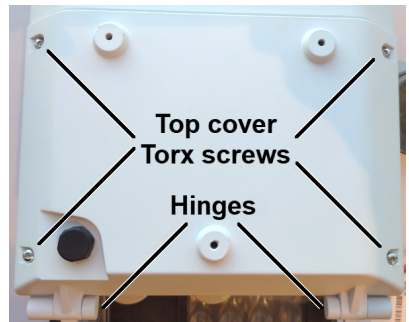



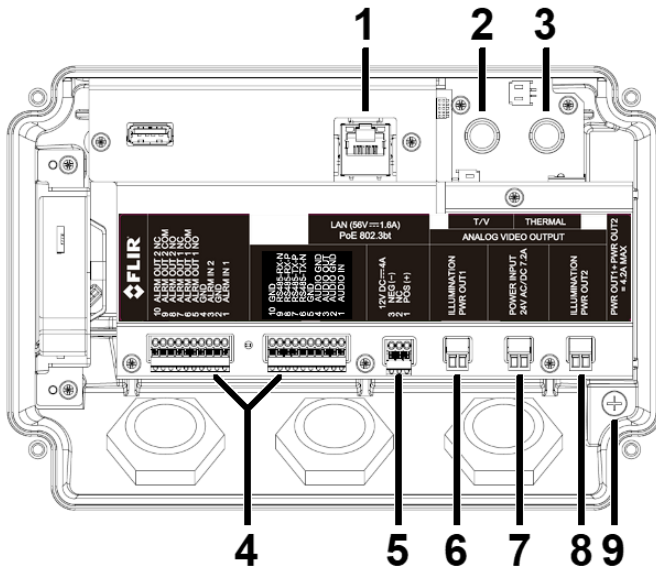

You do not need to remove the sunshield to open the cover. Nonetheless, if you want to remove the sunshield, loosen and remove the screws that attach it to the camera body. Then, carefully remove the sunshield.

- Open the camera cover to expose the inside of the camera body and the following connections.

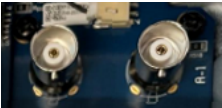
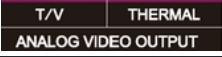
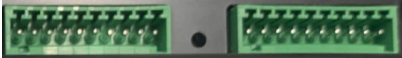

Camera Connections

Connection		Description							
1	LAN (56V~1.6A) PoE 802.3bt 	Attach a Cat 6 cable from the network switch to the RJ45 port for 100/1000 Mbps Ethernet and PoE. LED —Solid green indicates an active connection. Flashing orange indicates data traffic between the camera and the network.							
2	BNC x 2 	T/V—Analog visible or thermal video output; supports OSD	Attach to these connectors analog video cables rated RG59U or higher. You can configure the video format of the T/V connector and the on-screen display (OSD) using the camera's web page.						
3		Analog thermal video output; no OSD							
4	10-pin terminal block x 2 	Connect wires from alarm or audio I/O devices, or from IR LED illuminators, to the appropriate pins on a ten-pin connector included in the camera kit. For pin assignments, see diagram below. Then, plug the connectors into the terminal blocks.							
5	DC12V (IN) 	Connect wires from an external power supply to the three-pin connector included in the camera kit. Then, plug the connector into the terminal block.							
		Pin	<table border="1"> <tr> <td>1</td> <td>2</td> <td>3</td> </tr> <tr> <td>-</td> <td>NC</td> <td>+</td> </tr> </table>	1	2	3	-	NC	+
1	2	3							
-	NC	+							

Connection		Description
6	ILLUMINATION POWER OUT 1 AC24V	 <p>Connect wires from illuminators and an external power supply to the two-pin connectors included in the camera kit. Then, plug the connectors into the terminal blocks.</p> <div style="border: 2px solid orange; padding: 10px;"> <ul style="list-style-type: none"> Do not connect a DC12V power supply to the DC24V connection. Do not use the DC12V and AC24V / DC24V IN connections at the same time. The ILLUMINATION POWER OUT 1 + 2 AC24V connections can supply a maximum 4.2A total to external illuminators. They must be connected to equipment with fireproof enclosures. FH-Series cameras support Raytec Long-Range Infra-Red illuminator models VAR2-i6-1, VAR2-i6-2, VAR2-i8-1, VAR2-i8-2, and VAR2-i16-1. For information about which Raytec illuminator each model supports, see the <i>FLIR Security - Accessory Guide</i>. </div>
7	POWER INPUT 24V AC / DC 7.2A	
8	ILLUMINATION POWER OUT 2 AC24V	
9		Anchor a ground strap to this grounding lug and connect it to the nearest earth-grounding point.

10-Pin Connectors

Pin	Connection	Pin	Connection
1	AUDIO IN	1	ALARM IN 1
2	GND	2	GND
3	AUDIO OUT	3	ALARM IN 2
4	GND	4	GND
5	GND	5	ALARM OUT 1 NO
6	RS-485-TX-N	6	ALARM OUT 1 COM
7	RS-485-TX-P	7	ALARM OUT 1 NC
8	RS-485-RX-P	8	ALARM OUT 2 NO
9	RS-485-RX-N	9	ALARM OUT 2 COM
10	GND	10	ALARM OUT 2 NC

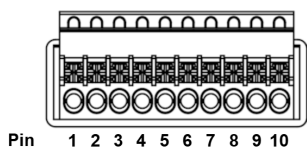

To use the camera's external IR illumination feature to turn illuminators on and off, connect them to ALARM OUT 2.

4 Configure for Networking

To discover the camera on the network, Teledyne FLIR recommends using the FLIR Discovery Network Assistant (DNA) tool. Version 2.3.0.20 or higher supports FH-Series, does not require a license to use, and is a free download from [the product's web page on the Teledyne FLIR website](#). You can also configure the

camera for networking using the camera's web page, or a supported VMS. Using the DNA tool or the camera's web page for initial configuration requires using the default admin user or any user assigned the admin or expert role.

Task	DNA tool	Camera's web page
Discover camera IP address	•	
Configure IP address, mask, and gateway	•	•
Configure IP address, mask, and gateway for more than one camera at the same time	•	
Configure DNS settings, MTU, and Ethernet speed		•

Notes

- For information about using the supported VMS to configure the camera, see the VMS documentation.
- For information about accessing the camera's web page, see the camera's installation and user guide.

By default, DHCP is enabled on the camera and a DHCP server on the network assigns the camera an IP address. For example, if the camera is managed by Teledyne FLIR's Horizon or Meridian VMS and the VMS is configured as a DHCP server, the VMS automatically assigns the camera an IP address.

If the camera is managed by Teledyne FLIR's Latitude VMS or is on a network with static IP addressing, you can manually specify the camera's IP address using the DNA tool or the camera's web page. The camera's default IP address is 192.168.0.250.

To manually specify the camera's IP address using the DNA tool:

- Run the DNA tool (DNA.exe) by double-clicking .

The Discover List appears, showing compatible devices on the LAN segment and their current IP addresses.

Device Type	Model name	Status	Login status	IP address	Name	Firmware version	MAC address
IP camera	DM-612	Online	Not authenticated	172.20.70.24	DM-612 999991		00:18:08:5
IP camera	DX-312	Online	Not authenticated	172.20.70.28	DX-312 120456		00:16:18:1
IP camera	FH-313	Online	Not authenticated	172.20.70.125	FH-313 045000		90:18:08:0
IP camera	FR-345-EST	Online	Not authenticated	172.20.70.90	FR-345-EST 91100213		00:18:08:7
IP camera	FR-345-EST	Online	Not authenticated	172.20.70.91	FR-345-EST 91100212		00:18:08:7
IP camera	FR-345-EST	Online	Not authenticated	172.20.70.92	FR-345-EST 91100230		00:18:08:7

In the DNA Discover List, verify that the camera's status is *Online*.

If this is the first time you are configuring the camera or if it is the first time after resetting the camera to its factory defaults, DNA automatically authenticates the camera with the default password for the camera's admin user (*admin*).

If the admin user password has been changed, you need to authenticate the camera.

In the DNA Discover List, right-click the camera and select **Login**.

IP camera	DX-312	Online	Not authenticated	172.20.
IP camera	FH-313	Online	Not authenticated	172.20.
IP camera	FR-345-EST	Online	Not authenticated	172.20.
IP camera	FR-345-EST	Online	Not authenticated	172.20.
IP camera	FR-345-EST	Online	Not authenticated	172.20.
IP camera	trk101	Online	Not authenticated	172.20.
IP camera	trk101	Online	Not authenticated	172.20.
IP camera	trk101	Online	Not authenticated	172.20.
IP camera	trk101	Online	Not authenticated	172.20.
IP camera	trk101	Online	Not authenticated	172.20.
IP camera	trk101	Online	Not authenticated	172.20.
IP camera	trk101P	Online	Not authenticated	172.20.
IP camera	trk101P	Online	Not authenticated	172.20.

In the **DNA - Login** window, type the password for the admin user. If you do not know the admin user password, contact the person who configured the camera's users and passwords.

Click **Login**, wait for  Ok status to appear, and then click **Close**.

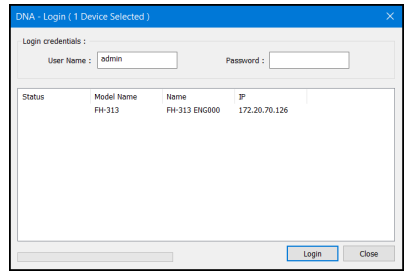

In the DNA Discover List, verify that the camera's status is *Authenticated*.

b. Change the camera's IP address.

Right-click the camera and select **IP Setup**.

In the **DNA - IP Setup** window, clear *Use DHCP* and specify the camera's *IP address*. You can also specify the *Mask* (default: 255.255.255.0) and *Gateway*.

Then, click **Update**, wait for  Ok status to appear, and then click **Close**.

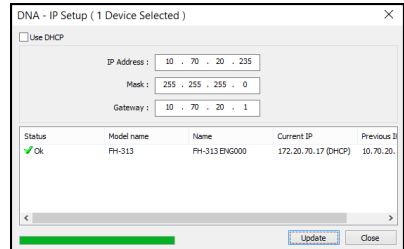

Close the Cover

Disconnect the camera.

Then, to prevent damaging the camera's internal components while moving it from the bench or lab to its mounting location, close the camera cover and either re-attach the sunshield or make sure to bring it to the mounting location.

At the mounting location, to connect the camera, remove the sunshield if necessary and open the cover again.

5 Mount the Camera

Teledyne FLIR offers accessories to mount the camera on a wall, on a large pole, on a small pole, in a corner, or on a pedestal.

Be sure to have the required accessories and tools available.

Install the mounting hardware for the camera according to the instructions for the hardware. If relevant, route power, network, and other cables into the mounting hardware so that they are accessible when the camera is mounted.

Typically, point the camera towards the ground while ensuring that the field of view includes as little of the skyline as possible. Teledyne FLIR recommends mounting the camera with zero horizontal rotation; that is, a 0° installation roll angle. For accurate video analytics, mount the camera with an installation roll angle within $\pm 5^\circ$.

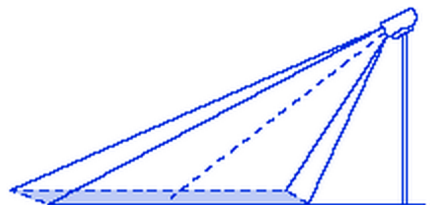

Attach the camera to the mounting surface using four 1/4"-20 UNC SUS 19mm screws, each with a metal flat washer, a spin washer, and a 1/4"-20 UNC nut. If you are mounting the camera on a wall using the FH-Series Wall Mount Kit (PN 421-0087-00), these items are supplied with the kit.

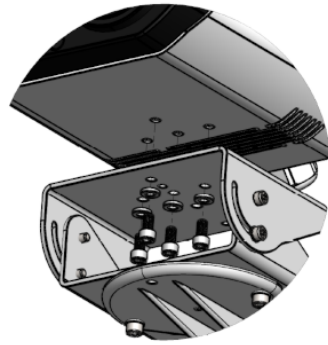

Attaching the Camera to 421-0087-00 Wall Mount Kit

6 Connect the Camera

Caution

Carefully following these instructions makes sure water does not enter the camera and ensures its long-term reliability. Teledyne FLIR is not responsible for damage to the camera cause by not adhering to these instructions.

Cables enter the camera body through liquid-tight 3/4" NPT compression glands, each with a gland seal insert and plugs for unused holes. To ensure watertight seals, the cable outer diameter must be between 0.23"-0.29". Carefully loosen and remove the gland nuts.

Remove the appropriate number of cable gland seal plugs. However, make sure seal plugs are securely in place for all unused gland seal holes.

Route the cables through the gland seals before terminating and connecting them. Leave the gland nuts loose until you have finished routing and connecting all of the cables.

Allow enough space for cable egress through the gland. The typical cable bend radius is 50-75mm (2-3").

According to the information in [Connect the Camera](#), terminate the cables and then connect them.

To ensure a watertight seal, fully tighten the gland nuts.

Close and Secure the Cover

Using the Torx wrench, alternately tighten the four screws that secure the cover to the camera; torque to 8+0.5 kgf-cm.

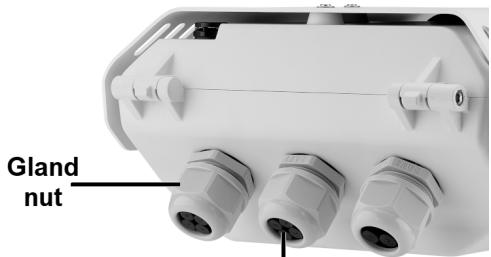

Cable Glands (Seal Inserts Not Shown)

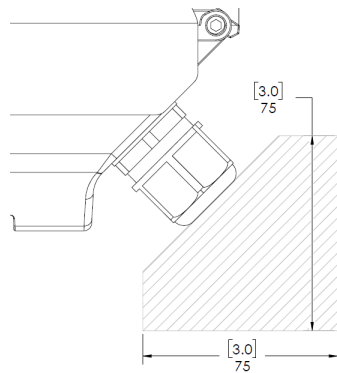

Cable Egress Space (75mm / 3" Bend Radius)



Caution

To ensure the camera's IP66 and IP67 dust and water ingress ratings, properly and securely close the camera cover and tighten the screws. Failure to do so can void the camera's warranty.

Re-attach the sunshield, if relevant.

7 Aim the Camera

The camera itself is stationary and does not provide physical aiming adjustment. For information about how to adjust mounting hardware to aim the camera, refer to the instructions for the mounting hardware.



Tips

Aim the camera while:

- you are or someone else is monitoring the camera's live video on the camera web page or in a video stream
- supporting the camera's weight with your hand or with the help of someone else

8 Check the Boresight

At the factory, the visible video image was aligned with the thermal video image. Users assigned the role of admin or expert can fine tune the video image alignment to the scene using the camera's web page. For more information, see the camera's installation and user guide.



Caution

When adjusting the camera's boresight, exercise extreme caution.

9 Configure the Analytics

Before creating analytics regions, check the camera's video analytics calibration.

- a. Log in to the camera's web page. For instructions on logging in to the camera's web page, see the camera's installation and user guide.
- b. On the camera's View Settings page, click Georeference.
- c. On the Georeference page, specify the camera's installation height, tilt angle, and roll angle. You can copy the camera's installation tilt and installation roll angles from the camera's onboard gyroscope.
- d. Click **Save**.
- e. Click **Video Analytics**. Then, on the Video Analytics page, expand the Overlay Settings, and enable the overlay.
- f. On the Visible tab, make sure analytics are enabled.
- g. Make sure that a person about 1.8m (5' 11") tall is in the camera's field of view.
- h. Click **Display Target**.

Installation Height (meters)	3
Installation Tilt (degrees)	-6.92
Installation Roll (degrees)	1.42

A box simulating a 1.8m (5' 11") person appears in the live video. Make sure the height of the box corresponds to the size of the person standing in the camera's field of view.

If it does not, on the Georeference page, verify the camera's installation height, tilt angle, and roll angle. On the Boresight page, make sure the visible and thermal video vertical fields of view are properly aligned.

- i. On the Thermal tab, make sure analytics are enabled, and repeat the previous two steps.

To create an analytics region:

- a. Under Add Region, click the appropriate icon.
- b. Specify each point of the region by clicking and releasing on the live video image. Do not click and drag. Also, do not draw one region line or border over another. For each region, the maximum number of points is 16.

To finish creating the region, double-click the last point. To cancel creating a region, press **Esc**.

- c. For tripwires and detection areas, you can specify direction, human or vehicle classification, or loitering time.

- d. After drawing at least two tripwires or detection areas for either the visible or the thermal video images, you can establish dependency between them.
- e. When you have finished configuring the regions, click **Save**.

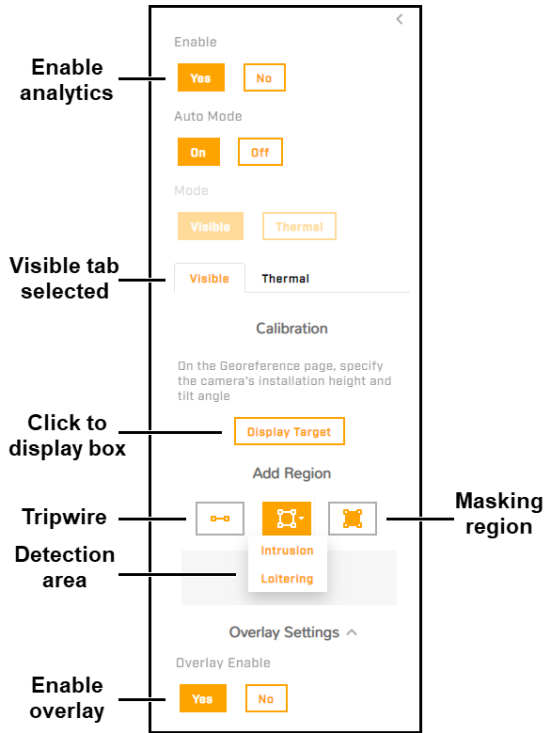

	Direction	Classification	Loitering time
Tripwire	•	•	
Intrusion		•	
Loitering		•	•
Masking	N/A		

Tips

- Remember to create analytics regions for the visible video image and for the thermal video images, if desired.
- By default, alarm rules triggered by the camera's video analytics are defined and disabled. Enable or modify these alarms, or define additional alarms, on the Alarm page in System Settings.
- For more information about the camera's video analytics and alarms, see the camera's installation and user guide.

10 Attach the Camera to a Supported VMS

After you have mounted the camera and discovered or defined its IP address, attach the camera to a supported VMS using its discovery/attach procedure.

11 Camera Dimensions

The FH-Series camera's dimensions are:

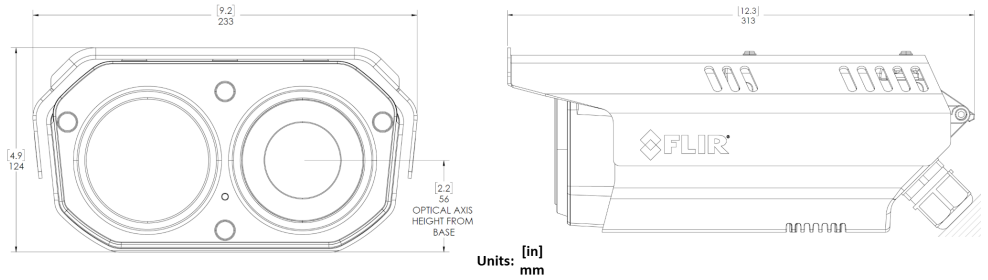

12 Register the Product

Register the product at <https://customer.flir.com>.

For warranty information, see <https://www.flir.com/support-center/warranty/security/flir-security-product-warranties/>.

13 Contact Information

Americas

6769 Hollister Avenue
Goleta, CA 93117

Support: <https://support.flir.com/>

27700 SW Parkway Ave.
Wilsonville, OR 97070