

Particle Counter

Model VPC260



Table of contents

1	Introduction.....	1
1.1	Product Feature Overview	1
1.2	Additional Features	1
2	Product Description	2
2.1	Meter Parts	2
2.2	Control and Function Buttons	3
2.3	Display Icon Descriptions	3
3	Rechargeable Battery	5
3.1	Battery Type	5
3.2	Charging the Battery	5
3.2.1	Charging with a USB Connection.....	5
3.2.2	Charging with AC Adaptor.....	5
3.3	Auto Power OFF (APO).....	5
4	Operation	6
4.1	Opening Screen	6
4.2	Measurement Screen	7
4.3	Measurement Preparation	8
4.3.1	Indoor Air Quality (IAQ) Considerations.....	8
4.3.2	System Settings and Test Setup.....	8
4.3.3	Zero Count Filter.....	8
4.4	Running a Test.....	9
5	Test Settings Menu	10
5.1	Accessing the Test Settings Menu	10
5.2	Test Setting Descriptions	10
5.2.1	Sample Time	10
5.2.2	Start Delay	11
5.2.3	Channel Display	11
5.2.4	Ambient Temperature / RH%	11
5.2.5	Sample Cycle.....	12
5.2.6	Sample Mode	12
5.2.7	Interval	13
5.2.8	Level Indication	13
6	System Settings Menu	15
6.1	Accessing the System Settings Menu	15
6.2	System Setting Descriptions	15
6.2.1	Date and Time.....	15

Table of contents

	6.2.2	Font Colour.....	16
	6.2.3	Language.....	16
	6.2.4	Brightness.....	17
	6.2.5	Auto Power OFF (APO).....	17
	6.2.6	Display Timeout.....	18
	6.2.7	Alarm.....	18
	6.2.8	Memory Status.....	19
	6.2.9	Factory Setting Reset.....	19
	6.2.10	Units.....	19
7		Record Browser.....	20
	7.1	Browser Overview.....	20
	7.2	Using the Browser.....	20
8		Particle Count Alarm.....	22
9		PC Interface.....	23
10		Maintenance.....	24
	10.1	Cleaning and Storage.....	24
	10.2	Battery Service.....	24
11		Specifications.....	25
	11.1	General Specifications.....	25
	11.2	Particle Counter Specifications.....	25
	11.3	Ambient Measurement Specifications.....	26
12		Limited Two-Year Warranty.....	27
13		Customer Support.....	28

1 Introduction

1.1 Product Feature Overview

Thank you for selecting the Extech VPC260 six (6) channel Particle Counter.

This meter provides quick and accurate particle count, air temperature, and relative humidity readings. Measurements are made with the built-in particle counting probe and temperature/relative humidity sensor. A zero count filter is supplied for purging particles from the meter before and after each use to ensure accuracy.

Readings are displayed on the colour TFT display with selectable font colour. Dew Point and Wet Bulb temperature calculations are also displayed.

This device is shipped fully tested and calibrated and, with proper use, will provide years of reliable service. Please visit the Extech website for customer support and downloads for user manuals and PC software.

1.2 Additional Features

- Simple menu-based setup and operation
- System settings menu for global options (date/time, LCD brightness, font colour, etc.)
- Test settings menu for test configurations (test time, start delay, test type, and more)
- Stores 1,000 test records
- PC interface for exporting test records to a spreadsheet
- Audible/visual particle count alarm with colour-coded bar graph
- Supplied zero count filter purges particles from the meter
- Rechargeable lithium-ion battery
- Selectable Auto Power Off time with Disable option
- Four language display options: English, French, German, Spanish
- Supplied USB-C cable for charging and PC interface
- Supplied 9 V adaptor
- Securely mounts on supplied tripod

2 Product Description

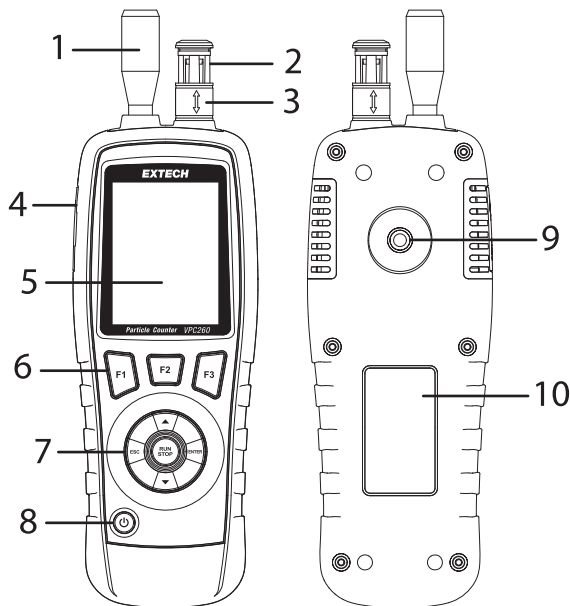

2.1 Meter Parts











1. Particle count probe
2. Temperature and RH sensor
3. Protective sliding sensor sleeve
4. Compartment for USB port and AC adaptor jack
5. Colour TFT LCD
6. Function buttons
7. Control buttons
8. ON/OFF button (long press)
9. Tripod mount
10. Safety information label





Note that the supplied zero particle count filter is not pictured.

2.2 Control and Function Buttons

F1	Function button F1 . Opens the test record browser. While in the browser, press to delete the selected test record.
F2	Function button F2 . Opens the System settings menu (from the opening screen) or the Test settings menu (from the measurement screen).
F3	Function button F3 . Opens the general information page.
RUN STOP	Start/stop a test. If an alarm is sounding, press to abort the test and silence the alarm.
ESC	Escape button. Press to return to previous screen.
ENTER	Press to open the measurement screen from the opening screen. Press to select and open menu items.
	Navigate menus and change settings.
	Long press to power ON/OFF.

2.3 Display Icon Descriptions

	Cumulative test mode: For each channel, this mode measures particles of the same size (or larger) than the channel label (2.5µm, 10µm, etc.).
	Differential test mode: For each channel, this mode measures particles of the same size (or larger) than the channel label (2.5µm, 10µm, etc.), up to the size of the next larger channel.
	Concentration mode: Quick particle count test for new test areas and areas that may exceed the measuring range of the meter.
	Battery charge status
	Colour coded particle count bar graph with animated pointer. Green indicates a low particle count, yellow indicates a moderate count, and red indicates a high count.
	Alarm alert flashes yellow (caution) or red (hazard) matching the status of the colour bar graph.
	Press F1 under this icon to open the test record browser.
	Press F1 under this icon in the test record browser to delete the highlighted record.
	Press F2 under this icon to open the System settings menu.

	Press <i>F3</i> under this icon to open the general information page.
	Press <i>F2</i> under this icon to open the Test settings menu.
	Test is running.
	Test is stopped/paused.

3 Rechargeable Battery

3.1 Battery Type

The meter is equipped with an internal rechargeable 3.7 V lithium-ion battery. The battery is not user-serviceable, please contact Extech service to coordinate a battery replacement.

3.2 Charging the Battery

This meter can be charged using the supplied 9 V adaptor or a USB connection to PC or 5 V charger.

A full charge requires 2 to 4 hours depending on battery condition and power source. The meter can run continuously for 4 hours (typical) on a full charge. The battery symbol on the LCD (upper right corner) provides battery charge status.

3.2.1 Charging with a USB Connection

1. Connect the supplied USB cable to the USB-C port under the flap on the meter's left side.
2. Connect the other end (USB-A) to a 5 V wall charger or PC USB port.

3.2.2 Charging with AC Adaptor

1. Connect the supplied 9 V AC adaptor to the jack under the flap on the meter's left side.
2. Connect the other end of the adaptor to an AC source (100 to 240 V, 50/60 Hz).
3. The meter can be charged and operated at the same time using the AC adaptor. To do so, press the **ENTER** button after connecting the adaptor to proceed to the opening screen.

3.3 Auto Power OFF (APO)

To conserve battery energy, the meter switches OFF automatically after 3, 15, or 60 minutes of inactivity. Set or disable the APO timer in the System settings menu.

4 Operation

 CAUTION
Keep the meter away from sources of electrical and magnetic energy as these can affect reading accuracy.
Do not operate this meter in areas of extremely high temperature (> 50°C [122°F]) or humidity (> 90% RH).

4.1 Opening Screen

Long press the power button  to switch the meter on.

The opening screen, shown below, will appear.

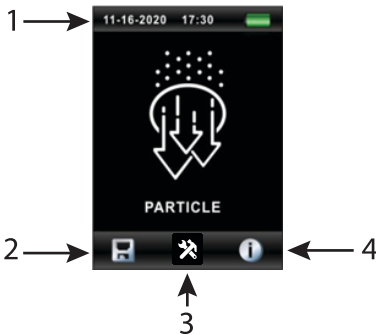

1. Date, time, and battery status icon.
2. Browser icon (for locating test records). Press **F1** to open the browser.
3. System settings menu icon. Press **F2** to open menu.
4. Information page icon. Press **F3** to open page.

4.2 Measurement Screen

Long press the power button  to switch the meter on. At the opening screen, press **ENTER** to access the measurement screen, shown below.

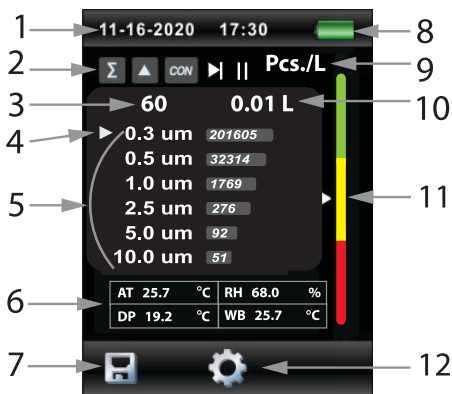

1. Current Date and time.
2. Sample mode icons Cumulative (Σ), Differential (Δ), Concentration (CON) and Run (>|), Pause (||) icons.
3. Recording sample rate (60 seconds, in this example).
4. Designated particle size channel that controls the alarm action and the animated colour bar graph pointer (see Section 8, *Particle Count Alarm*, and the *Level Indication* option in the Test settings menu for details on designating a channel and using the particle count alarm).
5. Particle count readings appear in the six (6) channel rows. The designated row, as described in item 4 above, has the white pointer icon in its row.
6. Ambient readings: **AT** (air temperature), **RH** (relative humidity), **DP** (dew point calculation), **WB** (wet bulb calculation).
7. Test record browser icon, press **F1** to open the browser.
8. Battery status icon.
9. Unit of measure (particles per litre, in this example).
10. Air volume.
11. The colour bar graph represents the particle count for the designated channel (see step 3, above).
12. Test settings menu icon, press **F2** to open the menu.

4.3 Measurement Preparation

4.3.1 Indoor Air Quality (IAQ) Considerations

Particle pollution is a mixture of various components including smoke, dust, chemicals, mold, and gases.

Evaluating IAQ by determining the concentration and size of these particles can help to determine if a problem exists. Locating the source of these particles can help to determine effective methods of reducing these and improving IAQ.

Air temperature, relative humidity, and CO₂ levels are also important considerations for IAQ, as high humidity and lower temperatures can bring about mold creation.

4.3.2 System Settings and Test Setup

Before testing, configure the System settings and Test settings. The System settings menu offers global options such as date/time, language, and LCD brightness. The Test settings menu allows you to set the test length, number of tests to run consecutively, interval between tests, test modes, and more.

See Section 5, *Test Settings Menu*, and Section 6, *System Settings Menu*, for complete instructions.

Press **F2** from the opening screen to open the System settings menu. Press **F2** from the measurement screen to open the Test settings menu.

4.3.3 Zero Count Filter

Particles must be purged before and after each use, especially in a high particle count environment. To start, unscrew and remove the Isokinetic particle count probe and attach the supplied zero count filter. Switch the meter on, and follow the steps below for the *Test Settings Menu* items (Section 5).

1. Set the *Sample Mode* to *Cumulative*.
2. Select all available channels in the *Channel Display* menu.
3. Set the *Sample Time* to 60 seconds.
4. Set the *Sample Cycle* to 10 test cycles.

Now, press **RUN** to start the test. When the test cycles have completed check that all channels read zero particles. You may need to run the test cycles several times to ensure that all channels are purged.

Finally, switch the meter off, remove the zero count filter, and reattach the particle count probe to begin testing.

4.4 Running a Test

1. Slide the protective temperature/RH sensor sleeve down to expose the sensor to the ambient air.
2. Long press the power button  to switch the meter ON.
3. Place the meter in the room under test. Mount the meter on the supplied tripod if desired.
4. Press the **RUN/STOP** button to start the programmed test. The meter's air pump will start.
5. The test will end automatically after the programmed test time.
6. View the particle count and ambient readings on the LCD as fully illustrated in Section 4.2, *Measurement Screen*.
7. A record of the test is automatically saved. Press **F1** to open the test record browser. In the browser, scroll with the arrows and press **ENTER** to open a record. Press **ESC** to return to the measurement screen. See Section 7, *Record Browser*, for complete information.
8. Test several areas of the room to form a complete picture of the indoor air quality. Compare readings taken outside the room with readings taken inside the room to determine the effectiveness of any installed air filtration systems.
9. Press the **RUN/STOP** button to stop a test manually (and to silence an alarm).



CAUTION



The life of the meter can be maximized by testing only when necessary and securely storing the instrument when it is not in use. Continuous use is not recommended and can shorten the life of the instrument especially in dusty environments.

NOTE

When testing in a designated ISO clean room, refer to the ISO Clean Room Class standard (ISO 14644-1:1999). The standard provides test limits that you can test against to verify compliance.

5 Test Settings Menu

5.1 Accessing the Test Settings Menu

1. Long press the power button  to switch the meter ON.
2. From the opening screen, press **ENTER** to access the measurement screen.
3. Press **F2** under the Test settings icon  to open the Test settings menu (shown below). Note that if you press **F2** on the **opening screen** you will access the System settings menu instead.

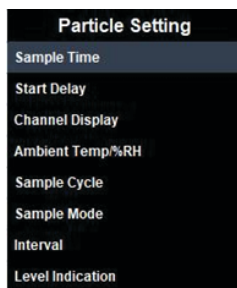

5.2 Test Setting Descriptions

5.2.1 Sample Time

Set the test duration from 3 to 180 seconds. This menu will also show the amount of air (in litres) that will be processed for the selected test time.

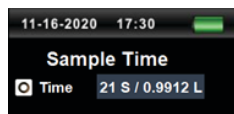

1. Scroll to the *Sample Time* selection in the menu.
2. Press **ENTER** to open the selection.
3. Press **ENTER** again to prepare the setting for editing.
4. Use the arrow buttons to set the sample time (test duration) from 3 to 180 seconds. Note that the numbers wrap, so you can scroll down from '3' to '180' seconds, for example.
5. Press **ESC** to save and return to the menu.

5.2.2 Start Delay

Add a delay (from 3 to 100 seconds) to the start of the tests.

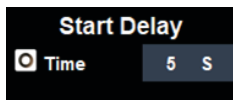

1. Scroll to the *Start Delay* selection in the menu.
2. Press **ENTER** to open the selection.
3. Press **ENTER** again to prepare the setting for editing.
4. Use the arrows to set the delay time from 3 to 100 seconds. Note that the numbers wrap, so you can scroll down from '3' to '100' seconds, for example.
5. Tests will not start until this delay time has elapsed (the LCD will show *WAIT* during the delay).
6. Press **ESC** to save the setting.

5.2.3 Channel Display

Choose the channels to include on the measurement screen.

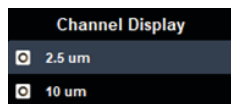

1. Scroll to the *Channel Display* selection in the menu.
2. Press **ENTER** to open the selection.
3. Use the arrow buttons to scroll to a channel.
4. Use the **ENTER** button to enable or disable the channel. The channel is disabled when the selection circle is black. Disabled channels will not appear on the measurement screen.
5. Press **ESC** to save the setting.

5.2.4 Ambient Temperature / RH%

Show or hide the ambient readings on the measurement screen.

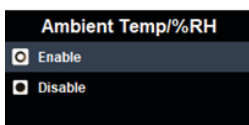

1. Scroll to the *Ambient Temperature / RH%* selection in the menu.
2. Press **ENTER** to open the selection.
3. Use the arrow buttons to select Enable or Disable.
4. When enabled, ambient measurements will appear on the measurement screen.
5. Press **ESC** to save the setting.

5.2.5 Sample Cycle

Set the number of tests (1 to 100) to run consecutively.

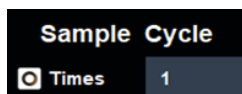

1. Scroll to the *Sample Cycle* selection in the menu.
2. Press **ENTER** to open the selection.
3. Press **ENTER** again to prepare the setting for editing.
4. Use the arrows to set the sample cycle from 1 to 100. The numbers wrap, so you can scroll from '1' down to '100', for example.
5. Press **ESC** to save the setting.

Note: To set the time between tests, use the *Interval* menu item.

5.2.6 Sample Mode

Select the test mode (Cumulative, Differential, or Concentration).

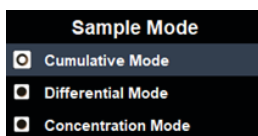

1. Scroll to the *Sample Mode* selection in the menu.
2. Press **ENTER** to open the selection.
3. Use the arrows to select the mode.
4. Press **ESC** to save the setting.

Cumulative Mode (represented by the sigma symbol Σ): Includes all particles that are \geq the selected particle size (2.5 μm , 10 μm , etc.). Choose this setting when using the zero particle filter.

Differential Mode (represented by the delta symbol Δ): Includes all particles that are \geq the selected particle size (2.5 μm , 10 μm , etc.) but $<$ the next largest particle size.

Concentration Mode (represented by the abbreviation 'CON'): This mode is used to take a quick sample of airborne particulates of all sizes, especially in areas where the particulate levels are unknown.

5.2.7 Interval

Set the time interval (1 to 100 seconds) between test cycles.

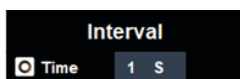

1. Scroll to the *Interval* selection in the menu.
2. Press **ENTER** to open the option.
3. Press **ENTER** to prepare the setting for editing.
4. Use the arrows to select the interval time from 1 to 100 seconds. Note that the numbers wrap, so you can scroll down from '1' to '100' seconds, for example.
5. Press **ESC** to save the setting.

Note: The *Interval* setting is used only for setting the time between **consecutive tests**, not between individual measurements.

5.2.8 Level Indication

Designate the channel (2.5 μm , 10 μm , etc.) that will trigger the audible/visual alarm when its particle count limit is exceeded. Note that only the particle count for the designated channel is represented by the colour bar graph.

Refer to the table in Section 8, *Particle Count Alarm*, to see the particle count range represented by each colour on the bar graph. Enable/Disable the alarm in the *Alarm* setting (System settings menu).

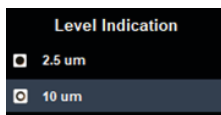



1. Scroll to the *Level Indication* selection in the menu.
2. Press **ENTER** to open the option.

3. Use the arrows to designate the channel that will control the alarm and the colour bar graph.
4. Press **ESC** to save the setting.

6 System Settings Menu

6.1 Accessing the System Settings Menu

1. Long press the power button  to switch the meter ON.
2. Press **F2** under the System settings icon  to open the menu (shown below).

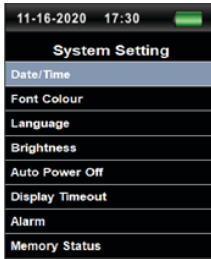

6.2 System Setting Descriptions

6.2.1 Date and Time



1. Scroll to the *Date/Time* selection in the menu.
2. Press **ENTER** to open the selection for editing.
3. Use the **ENTER** button to move from field to field.
4. Use the arrow buttons to change a setting.
5. Press the **ESC** button to save the setting and return to the menu.

6.2.2 *Font Colour*

Select the colour for displayed text.

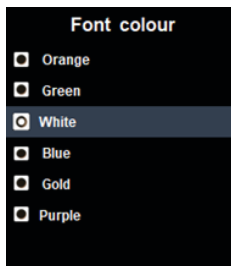

1. Scroll to the *Font Colour* selection in the menu.
2. Press **ENTER** to open the selection for editing.
3. Use the arrows to highlight the desired colour.
4. Press **ESC** to save the setting.

6.2.3 *Language*

Select a language for menu text.



1. Scroll to the *Language* selection in the menu.
2. Press **ENTER** to open the selection for editing.
3. Use the arrows to highlight a language.
4. Press **ESC** to save the setting.

6.2.4 *Brightness*

Adjust the LCD brightness.



1. Scroll to the *Brightness* selection in the menu.
2. Press **ENTER** to open the selection for editing.
3. Use the arrows to highlight the desired brightness level.
4. Press **ESC** to save the setting.

6.2.5 *Auto Power OFF (APO)*

Set or disable the APO timer.

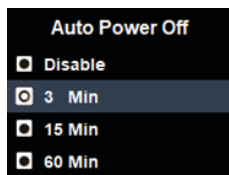

1. Scroll to the *Auto Power Off* selection in the menu.
2. Press **ENTER** to open the selection for editing.
3. Use the arrows to highlight the desired APO time (or select Disable).
4. Press **ESC** to save the setting.

6.2.6 *Display Timeout*

To conserve battery energy, the meter can switch off the display after a programmed time. This will not affect meter operation. Press any key to wake the display.



1. Scroll to the *Display Timeout* selection in the menu.
2. Press **ENTER** to open the selection for editing.
3. Use the arrow buttons to select 90 seconds, 2 minutes, 4 minutes, or Disable.
4. Press **ESC** to save the setting.

6.2.7 *Alarm*

Enable or disable the alarm function. When enabled the meter audibly/visually alerts you when the particle count measurement exceeds the limit for the designated channel. See Section 8, *Particle Count Alarm*, for more information.



1. Scroll to the *Alarm* selection in the menu.
2. Press **ENTER** to open the selection for editing.
3. Use the arrow buttons to highlight Enable or Disable.
4. Press **ESC** to save the setting.

6.2.8 Memory Status

Check the number of records stored in memory.

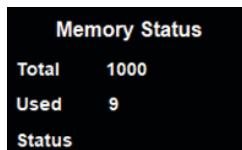

1. Scroll to the *Memory Status* selection in the menu.
2. Press **ENTER** to open the status page.
3. The status page shows the number of records stored. Up to 1,000 records can be stored.
4. Press **ESC** to return to the menu.

6.2.9 Factory Setting Reset

Restore the meter's default settings.

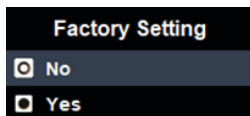

1. Scroll to the *Factory Setting* selection in the menu.
2. Press **ENTER** to open the selection.
3. Scroll to YES to reset the meter. Scroll to NO to leave the meter unchanged.
4. Press **ESC** to execute the action and to return to the menu.

6.2.10 Units

Select the unit of measure (°C or °F) for temperature displays.

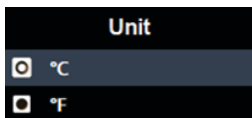

1. Scroll to the *Unit* selection in the menu.
2. Press **ENTER** to open the selection.
3. Use the arrows to highlight the desired unit.
4. Press **ESC** to save the setting.

7 Record Browser

7.1 Browser Overview

The meter can store up to 1,000 records, each test is automatically saved as a record. Records include particle count, ambient measurements, and time/date. You can export records to a spreadsheet using the PC interface, see Section 9.

7.2 Using the Browser

To open the browser, press **F1** under the browser icon  and use the arrows to scroll through the record list.

Press **F1** under the trash icon  to delete a highlighted record.

Press **ENTER** to open a highlighted record.

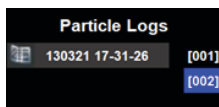

Press **ESC** to return to the Browser. A description of the test record screen is provided below.

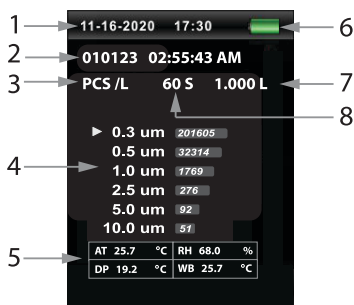

1. Current date and time.
2. Data log time and date.
3. Measurement unit (particles per litre, in this example).
4. Particle count channels with readings.
5. Ambient measurements.
6. Battery status.

7. Air volume.
8. Recording sample rate (60 seconds, in this example).
9. Date and time of test.

Open the *Memory Status* menu item in the System settings menu to check the number of records stored (maximum 1,000 records).

8 Particle Count Alarm

The meter alerts you (visually and audibly) when the particle count limit, for the designated channel, is exceeded.

Designate the channel that will control the alarm using the *Level Indication* menu item, explained in step 2, below.

The animated colour bar graph shows the particle count status for the designated channel. Green indicates a normal condition, yellow indicates caution, and red indicates a hazardous condition.

A yellow or red bell icon will flash and the beeper will sound when readings are in the yellow or red region. Press **RUN/STOP** to abort a test and silence the alarm.

1. Enable the alarm function in the *Alarm* menu item, in the System settings menu.
2. Designate a channel (2.5µm, 10µm, etc.) using the *Level Indication* menu item (Test settings menu). The designated channel controls the visual/audible alarm and the colour bar graph's animated pointer.
3. The table below shows the particle count range for each bar graph colour, for each channel.

Channel	Green (good)	Yellow (caution)	Red (hazard)
0.3µm	0 to 100,000	100,001 to 250,000	250,001 to 500,000
0.5µm	0 to 35,200	35,201 to 87,500	87,501 to 175,000
1.0µm	0 to 8,320	8,321 to 20,800	20,801 to 41,600
2.5µm	0 to 545	546 to 1,362	1,363 to 2,724
5.0µm	0 to 193	194 to 483	484 to 966
10.0µm	0 to 68	69 to 170	171 to 340

Note that the range of particle sizes for each colour, in the table above, is meant to be used as a guideline only, and is not derived from an industry standard, or regulatory body.

9 PC Interface

This meter is Windows® PC compatible, you can download the software from the VPC260 product page on the Extech website.

A USB-C to USB-A cable is supplied and connects to the USB-C jack, located under the flap on the left side of the meter, and to a USB-A port on your PC. The meter has a built-in USB driver that connects the meter to the PC. Refer to the Software Help information contained in the VPC260 software for complete instructions.

The test records stored in the meter are in *.csv text format. Copy these files to your PC and open them in a spreadsheet to view the time-stamped measurement data. Use these data to create test reports and other records as desired.

10 Maintenance

10.1 Cleaning and Storage

Wipe the meter housing with a damp cloth as necessary, do not use abrasives or solvents. Slide the temperature/RH sensor's protective sleeve to the 'up' position to protect the sensor when cleaning or when storing. Do not allow moisture to enter the particle counter probe.

When storing the meter for long periods, secure the meter in the original case and charge it to at least 70% power (recharge at 6 month intervals).

10.2 Battery Service

The battery cannot be serviced or replaced by the user, if the battery will not charge, or if you notice other battery abnormalities, please contact Extech directly, or through your point of purchase.

For instructions on charging the battery, see Section 3.

11 Specifications

11.1 General Specifications

Display	5.6 x 7.1 cm (2.2 x 2.8 in.) TFT colour LCD
Battery status indication	Animated battery charge symbol on top right of LCD
Internal memory	Up to 1,000 test records
Power supply	Rechargeable 3.7 V lithium-ion battery
	9 V AC adaptor; 100 to 240 V (50/60 Hz)
Battery life	Four (4) hours minimum of continuous use (typical)
Battery charge time	2 to 4 hours, depending on battery condition and power source
Operating temperature	0 to 50°C (32 to 122°F)
Storage temperature	-10 to 60°C (14 to 140°F)
Operating/Storage humidity	10 to 90% RH, non-condensing
Mounting	Tripod mount (on back). Tripod supplied
Dimensions	240 x 75 x 57 mm (9.4 x 3.0 x 2.2 in.)
Weight	332 g (11.7 oz.)
Certifications	CE, RoHS, REACH, PROP 65

11.2 Particle Counter Specifications

Channels	Six (6) particle size channels: 0.3, 0.5, 1.0, 2.5, 5.0, and 10µm
Flow rate	1 litre per minute (0.035 ft ³ per minute) controlled by internal pump
Measurement range	0 to 999,999 particles / litre
Counting efficiency	50% at 0.3µm; 98% for particles ≥ 0.5µm
Coincidence limit (loss)	10% at 2,000,000 particles per cubic foot
Particle count modes	Cumulative, Differential, and Concentration

11.3 Ambient Measurement Specifications

Air Temperature Range	0 to 50°C (32 to 122°F)
Air Temperature Resolution	0.1°C/°F
Air Temperature Accuracy	±0.5°C (0.9°F) from 10 to 40°C (50 to 104°F)
	±1.0°C (1.8°F) all other ranges
Relative Humidity Range	0 to 100% RH
Relative Humidity Resolution	0.1%
Relative Humidity Accuracy	±3% RH from 20 to 80% RH
	±5.0% RH all other ranges
Dew Point and Wet Bulb temperatures are calculations; their specifications match the air temperature specifications above.	

12 Limited Two-Year Warranty

*FLIR Systems, Inc. warrants this Extech brand instrument to be free of defects in parts and workmanship for **two years** from date of shipment. To view the full warranty text please visit:*

<https://www.extech.com/support/warranties>

13 Customer Support

Customer Support Telephone List: <https://support.flir.com/contact>

Main Support Site: <https://support.flir.com>

User Manual and PC Software Downloads:

www.extech.com

Website

<http://www.flir.com>

Customer support

<http://support.flir.com>

Copyright

© 2023, FLIR Systems, Inc. All rights reserved worldwide.

Disclaimer

Specifications subject to change without further notice. Models and accessories subject to regional market considerations. License procedures may apply. Products described herein may be subject to US Export Regulations. Please refer to exportquestions@flir.com with any questions.

Publ. No.: NAS100084
Release: AA
Commit: 93064
Head: 93076
Language: en-GB
Modified: 2023-08-25
Formatted: 2023-08-25