

C.A 6165



Multi-function electrical equipment tester

Measure up



About the user's manual

- › This Instruction manual contains detailed information on the C.A 6165, its key features, functionalities and use.
- › It is intended for technically qualified personnel responsible for the product and its use.
- › Please note that LCD screenshots in this document may differ from the actual instrument screens due to firmware variations and modifications.

Contents

1	General description	6
1.1	Warnings and notes	6
1.1.1	Safety warnings	6
1.1.2	Warnings related to safety of measurement functions	6
1.1.3	Markings on the instrument	7
1.2	Standards applied	8
	<i>Erection and operation of electrical test equipment</i>	8
2	Instrument set and accessories	9
2.1	Standard set of the instrument	9
2.2	Accessories and spares	9
3	Instrument description	10
3.1	Front panel	10
4	Instrument operation	12
4.1	General meaning of keys	12
4.2	General meaning of touch gestures	12
4.3	Safety checks	13
4.4	Symbols and messages	13
4.5	Instrument main menu	17
4.6	General settings	18
4.6.1	Language	19
4.6.2	Date and time	19
4.6.3	Profiles	19
4.6.4	Workspace Manager	19
4.6.5	Auto Sequence® groups	19
4.6.6	User accounts	20
4.6.7	Change password for HV functions	25
4.6.8	Settings	26
4.6.9	Devices	27
4.6.10	Initial Settings	28
4.6.11	About	29
4.7	Instrument profiles	29
4.8	Workspace Manager	30
4.8.1	Workspaces and Exports	30
4.8.2	Workspace Manager main menu	30
4.9	Auto Sequence® groups	35
4.9.1	Auto Sequence® groups menu	35
5	Memory Organizer	38
5.1	Memory Organizer menu	38
5.1.1	Measurement statuses	39
5.1.2	Structure Objects	39
5.1.3	Selecting an active Workspace in Memory Organizer	40
5.1.4	Adding Nodes in Memory Organizer	41
5.1.5	Operations in Tree menu	42
5.1.6	Searching in Memory Organizer	56
6	Single tests	59
6.1	Selection of single tests	59
6.1.1	Single test screens	61
6.1.2	Single test (inspection) screens	65
6.1.3	Help screens	68
6.2	Single test measurements	69
6.2.1	Visual inspections	69
6.2.2	Continuity	70
6.2.3	HV AC	73
6.2.4	HV DC	74
6.2.5	HV AC programmable	76
6.2.6	HV DC programmable	78
6.2.7	Insulation resistance (Riso, Riso-S)	80

6.2.8	Sub-leakage (Isub, Isub-S)	82
6.2.9	Differential Leakage	84
6.2.10	Ipe Leakage	86
6.2.11	Touch Leakage	87
6.2.12	Power	89
6.2.13	Leak's & Power	90
6.2.14	Discharging Time	92
6.2.15	Functional inspections	96
7	Auto Sequences®	97
7.1	Selection of Auto Sequences®	97
7.1.1	Selecting an active Auto Sequence® group in Auto Sequences® menu	97
7.1.2	Searching in Auto Sequences® menu	98
7.1.3	Structure organization of Auto Sequence® group	100
7.2	Organization of Auto Sequence® tests	101
7.2.1	Auto Sequence® view menu	101
7.2.2	Step by step execution of Auto Sequences®	104
7.2.3	Auto Sequence® result screen	105
7.2.4	Auto Sequence® memory screen	107
8	Communications	108
8.1	USB and RS232 communication with PC	108
8.2	Bluetooth communication	108
8.3	Bluetooth communication with printers and scanners	109
8.4	Ethernet communication	109
8.5	RS232 communication with other external devices	109
8.6	Connections to test adapters	109
8.6.1	Test connector TC1	109
8.7	INPUTs	110
8.8	OUTPUTs	111
9	Technical specifications	112
9.1	HV AC, HV AC programmable	112
9.2	HV DC, HV DC programmable	112
9.3	Continuity	113
9.4	Insulation Resistance, Insulation Resistance-S	113
9.5	Substitute Leakage Current, Substitute Leakage Current - S	114
9.6	Differential Leakage current	114
9.7	PE leakage current	115
9.8	Touch leakage current	115
9.9	Power	115
9.10	Leak's & Power	116
9.11	Discharging time	118
9.12	General data	118
10	Maintenance	120
10.1	Fuses	120
10.2	Cleaning	120
11	Warranty	121
Appendix A - Structure objects in C.A 6165		122
Appendix B - Profile Notes		123
Appendix C - Print labels and write / read RFID / NFC tags		124
C.1	PAT tag format	124
C.2	Generic tag format	124
Appendix D - Default list of Auto Sequences®		126
Appendix E - Programming of Auto Sequences® on MTLINK		127
E.1	Auto Sequence® Editor workspace	127
E.2	Managing of Auto Sequence® groups	128
E.2.1	Auto Sequence® Name, Description and Image editing	130
E.2.2	Search within selected Auto Sequence® group	130
E.3	Elements of an Auto Sequence®	131
E.3.1	Auto Sequence® steps	131

E.3.2	Single tests.....	131
E.3.3	Flow commands.....	132
E.3.4	Number of measurement steps.....	132
E.4	Creating / modifying an Auto Sequence®.....	132
E.5	Description of flow commands.....	133
E.6	Custom Inspections programming.....	137
E.6.1	Creating and editing Custom Inspections.....	137
E.6.2	Applying Custom Inspections.....	139

1 General description

1.1 Warnings and notes



1.1.1 Safety warnings

In order to reach high level of operator safety while carrying out various measurements using the C.A 6165 instrument, as well as to keep the test equipment undamaged, it is necessary to consider the following general warnings:

- › Read this Instruction manual carefully, otherwise use of the instrument may be dangerous for the operator, for the instrument or for the equipment under test!
- › Consider warning markings on the instrument!
- › If the test equipment is used in manner not specified in this Instruction manual the protection provided by the equipment may be impaired!
- › Do not use the instrument and accessories if any damage is noticed!
- › Regularly check the instrument and accessories for correct functioning to avoid hazard that could occur from misleading results.
- › Consider all generally known precautions in order to avoid risk of electric shock while dealing with hazardous voltages!
- › Use only standard or optional test accessories supplied by your distributor!
- › Only test adapters provided or approved by Chauvin Arnoux should be connected to TC1 (test and communication) connectors.
- › Use only earthed mains outlets to supply the instrument!
- › In case a fuse has blown refer to chapter 8.2 *Fuses* in this Instruction manual to replace it!
- › Instrument servicing and calibration is allowed to be carried out only by a competent authorized person!
- › Chauvin Arnoux is not responsible for the content of the user-programmed Auto Sequences®!

1.1.2 Warnings related to safety of measurement functions

1.1.2.1 HV AC, HV DC, HV AC programmable, HV DC programmable

- › A dangerous voltage up to 5 kV_{AC} or 6 kV_{DC} is applied to the HV instrument outputs during the test. Therefore special safety consideration must be taken when performing this test!
- › Only a skilled person familiar with hazardous voltages can perform this measurement!
- › DO NOT perform this test if any damage or abnormality (test leads, instrument) is noted!
- › Never touch exposed probe tip, connections equipment under test or any other energized part during the measurements. Make sure that NOBODY can contact them either!

- › DO NOT touch any part of test probe in front of the barrier (keep your fingers behind the finger guards on the probe) – possible danger of electric shock!
- › It is a good practice to use lowest possible trip-out current.





1.1.2.2 Diff. Leakage, Ipe Leakage, Touch Leakage, Power, Leak's & Power

- › Load currents higher than 10 A can result in high temperatures of fuse holders and On/Off switch! It is advisable not to run tested devices with load currents above 10 A for more than 15 minutes. Recovery period for cooling is required before proceeding with tests! Maximum intermittent duty cycle for measurements with load currents higher than 10 A is 50 %.

1.1.2.3 Insulation resistance

- › Do not touch the test object during the measurement or before it is fully discharged! Risk of electric shock!

1.1.3 Markings on the instrument

- ›  WARNING, risk of DANGER! The operator should refer to this user's manual whenever this danger symbol appears.
- ›  WARNING! Risk of electric shock. The voltage on the parts marked with this symbol may be dangerous.
- ›  The CE marking indicates compliance with the European Low Voltage Directive (2014/35/EU), Electromagnetic Compatibility Directive (2014/30/EU), Radio Equipment Directive (2014/53/EU), and Restriction of Hazardous Substances Directive (RoHS, 2011/65/EU and 2015/863/EU).
- ›   The rubbish bin with a line through it indicates that, in the European Union, the product must undergo selective disposal in compliance with Directive WEEE 2012/19/EU. This equipment must not be treated as household waste.

1.2 Standards applied

The C.A 6165 instrument is manufactured and tested according to the following regulations, listed below.

Electromagnetic compatibility (EMC)

IEC/EN 61326-1	Electrical equipment for measurement, control and laboratory use - EMC requirements – Part 1: General requirements Class B (Portable equipment used in controlled EM environments)
----------------	---

Safety (LVD)

IEC/EN 61010-1	Safety requirements for electrical equipment for measurement, control, and laboratory use – Part 1: General requirements
IEC/EN 61010-2-034	Safety requirements for electrical equipment for measurement, control, and laboratory use – Part 2-034: Particular requirements for measurement equipment for insulation resistance and test equipment for electric strength
IEC/EN 61010-031	Safety requirements for electrical equipment for measurement, control and laboratory use – Part 031: Safety requirements for hand-held probe assemblies for electrical measurement and test
IEC 61557	Electrical safety in low voltage distribution systems up to 1 000 V a.c. and 1 500 V d.c. – Equipment for testing, measuring or monitoring of protective measures Instrument complies with all relevant parts of IEC 61557 standards.

Functionality

IEC 60335	Household and similar electrical appliances
IEC 60950	Information technology equipment – Safety
IEC 61439	Low-voltage switchgear and controlgear assemblies
EN 60204-1	Safety of machinery - Electrical equipment of machines - Part 1: General requirements
EN 61180	High-voltage test techniques for low-voltage equipment - Definitions, test and procedure requirements, test equipment
IEC 62368-1	Audio/video, information and communication technology equipment – Part 1: Safety requirements
IEC 60598	Safety of lighting equipment
EN 50699 (VDE 0702)	Recurrent Test of Electrical Equipment
EN 50678 (VDE0701)	General procedure for verifying the effectiveness of the protective measures of electrical equipment after repair
IEC 50191	Erection and operation of electrical test equipment

2 Instrument set and accessories

2.1 Standard set of the instrument

- › Instrument C.A 6165
- › Bag for accessories
- › HV test probes 2 m, 2 pcs
- › Continuity test lead set 2.5 m, 2 pcs
- › Continuity test lead red 1.5 m / 2.5 mm²
- › Test lead black 2.5 m
- › Test lead red 2.5 m
- › Alligator clips black 2 pcs
- › Alligator clips red 3 pcs
- › Mains cable (2 m, wire cross-section 3 x 1.5 mm²)
- › RS232 cable
- › USB cable
- › Calibration Certificate
- › Short form instruction manual
- › A sheet with the administrator password for unlocking in the event of loss of the administrator password. To be stored in a safe place.

Download the MTLINK software. Refer to the quick start guide.

2.2 Accessories and spares

For accessories and spares, visit our web site:

www.chauvin-arnoux.com

3 Instrument description

3.1 Front panel

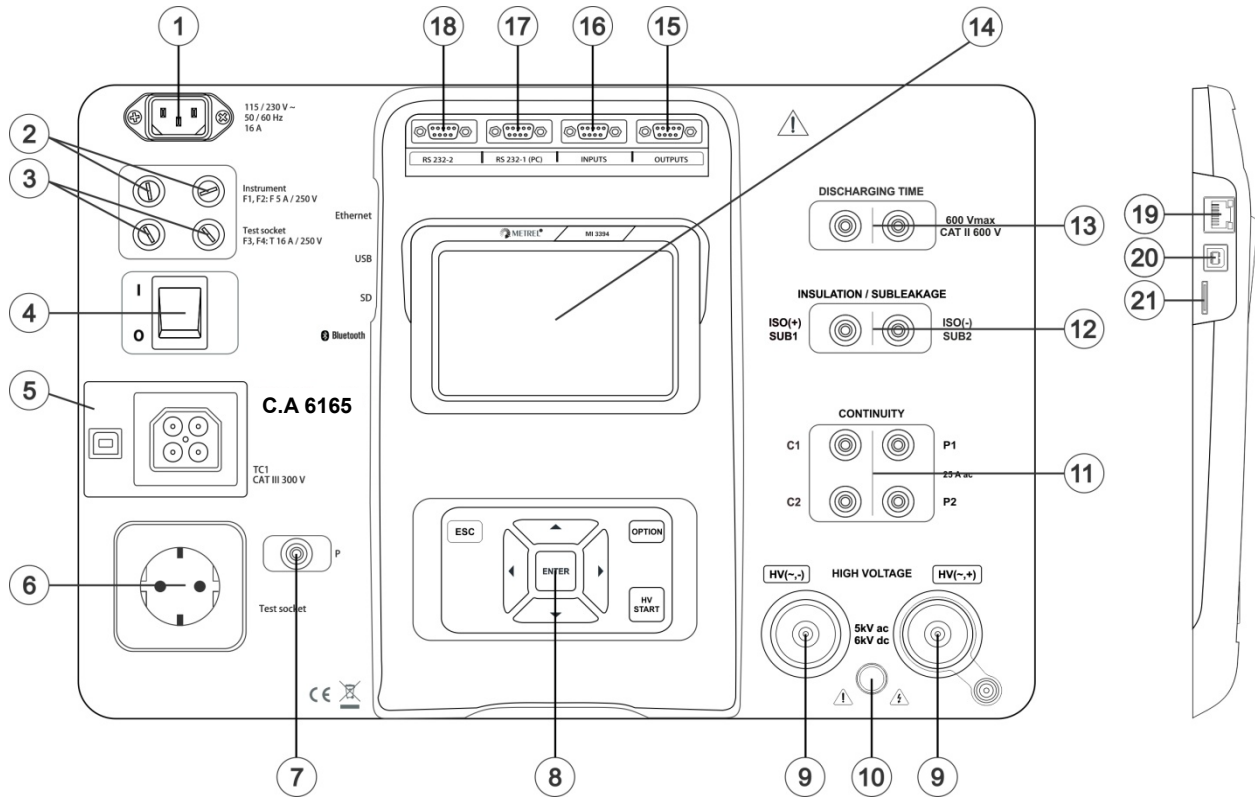

Figure 3.1: Front panel

1	Mains supply connector
2	F1, F2 fuses (F 5 A / 250 V)
3	F3, F4 fuses (T 16 A / 250 V)
4	On / Off switch
5	Test connections TC1 for external test adapters
6	Mains test socket
7	P/S (probe) connector
8	Keypad
9	HV output connectors
10	HV output warning lamp
11	Continuity connectors
12	Insulation / Subleakage connectors
13	Discharging time connectors
14	Colour TFT display with touch screen
15	Control outputs

16	Control inputs
17	Multipurpose RS232-1 port
18	Multipurpose RS232-2 port
19	Ethernet connector
20	USB connector
21	MicroSD card slot

Note : The instrument contains dedicated connectors intended to be connected only to dedicated accessories provided or approved by Chauvin Arnoux.

4 Instrument operation

The C.A 6165 can be manipulated via a keypad or touch screen.

4.1 General meaning of keys

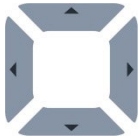

Cursor keys are used to:

- select appropriate option



Enter key is used to:

- confirm selected option
- start and stop measurements



Escape key is used to:

- return to previous menu without changes
- abort measurements



Option key is used to:

- expand column in control panel
- show detailed view of options



HV Test key is used to:

- start and stop HV tests

4.2 General meaning of touch gestures



Tap (briefly touch surface with fingertip) is used to:

- select appropriate option
- confirm selected option
- start and stop measurements



Swipe (press, move, lift) up/ down is used to:

- scroll content in same level
- navigate between views in same level



long

Long press (touch surface with fingertip for at least 1 s) is used to:

- select additional keys (virtual keyboard)
- enter cross selector from single test screens



Tap Escape icon is used to:

- return to previous menu without changes
- abort measurements

4.3 Safety checks

At start up and during operation the instrument performs various safety checks to ensure safety and to prevent any damage. These safety pre-tests are checking for:

- › Correct input mains voltage
- › Presence of input PE connection,
- › Any external voltage against earth on mains test socket
- › Excessive leakage currents through measuring I/Os,
- › Too low resistance between L and N of tested device,
- › Proper operation of safety relevant internal electronic circuits

If a safety check fails, an appropriate warning message will be displayed and safety measures will be taken. The warnings and safety measures are described in chapter 4.4 Symbols and messages.

4.4 Symbols and messages

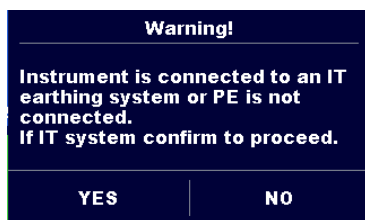

Supply voltage warning

Possible causes:

- › No earth connection.
- › Instrument is connected to an IT earthing system. Press **YES** to continue normally or **NO** to continue in a limited mode (measurements are disabled).

Warning:

The instrument must be earthed properly to work safely!

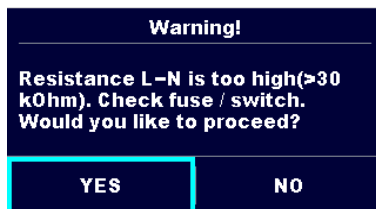

Resistance L-N > 30 kΩ

In pre-test a high input resistance was measured. Possible causes:

- › Device under test is not connected or switched on
- › Input fuse of device under test is blown.

Select **YES** to proceed with or **NO** to cancel measurement.

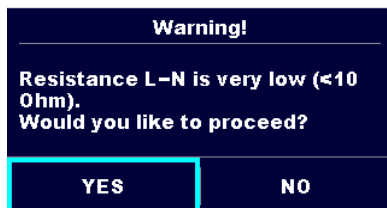

Resistance L-N < 10 Ω

In pre-test a very low resistance of the device under test supply input was measured. This can result in a high current after applying power to the device under test. If the too high current is only of short duration (caused by a short inrush current) the test can be performed otherwise not.

Select **YES** to proceed with or **NO** to cancel measurement

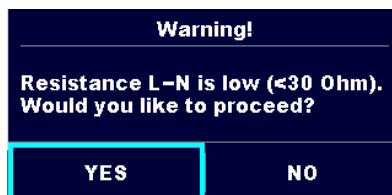

Resistance L-N < 30 Ω

In pre-test a low input resistance of the device under test was measured. This can result in a high current after applying power to the device. If the high current is only of short duration (caused by a short inrush current) the test can be performed, otherwise not.

Select **YES** to proceed with or **NO** to cancel measurement.

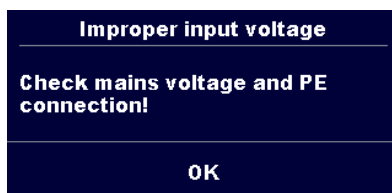

Warning for improper supply voltage condition. If pressing **OK** instrument will continue to work in a limited mode (measurements are disabled).

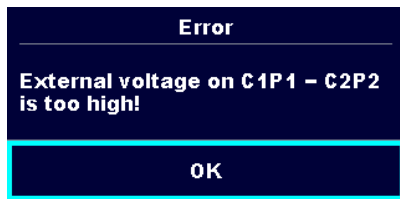

In pre-test an external voltage between C1/P1 and C2/P2 terminals was detected. The measurement was cancelled. Press **OK** to continue.

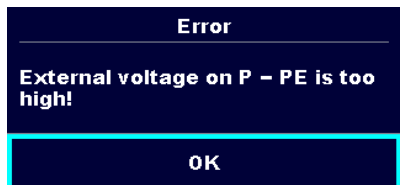

In pre-test a too high external voltage was detected between P and PE terminals. The measurement was cancelled. Press **OK** to continue.

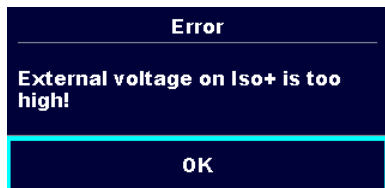

In pre-test a too high external voltage was detected between ISO/SUB and PE terminals. The measurement was cancelled. Press **OK** to continue.

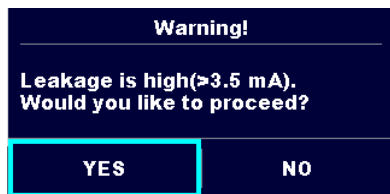

In pre-test a possible high leakage current was detected. It is likely that a dangerous leakage current (higher than 3.5 mA) will flow after applying power to the device under test.

Select **YES** to proceed with or **NO** to cancel measurement.

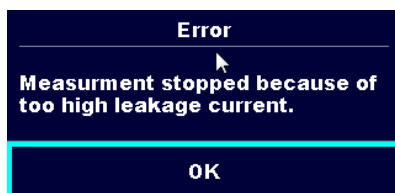

The measured leakage (I_{diff} , I_{pe} , I_{touch}) current was higher than 20 mA. Measurement was aborted. Press **OK** to continue.

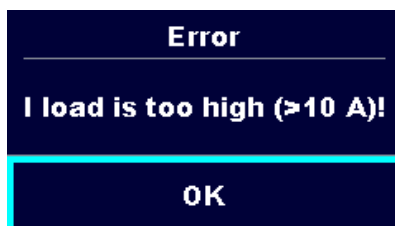

The load current exceeded the highest upper limit of 10 A for the Discharging time test. Measurement was aborted. Press **OK** to continue.



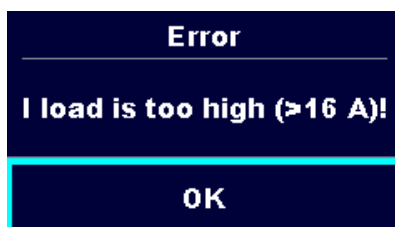



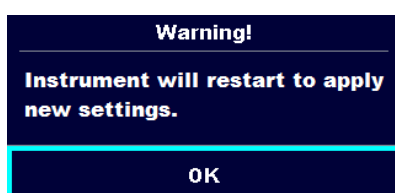









The load current continuously exceeded 10 A for more than 4 min (moving average) in Power and Leakage tests. Measurement was stopped for safety. Press **OK** to continue.



The load current exceeded the highest upper limit of 16 A for the Power and Leakage tests. Measurement was aborted. Press **OK** to continue.



Warning for restart of the instrument to set new Ethernet settings. This message appears on exit from Settings menu after changing Ethernet settings. Press **OK** to continue.

	The instrument is overheated. The measurement can't be carried out until the icon disappears. Press OK to continue.
	The device under test should be switched on (to ensure that the complete circuit is tested).
	Test voltage in Insulation resistance measurement is too low.
	Measurement result is scaled to 110 V.
	Red dot indicates phase of measurement where higher leakage was measured. Applicable only if phase reversal is enabled during the measurement.
	Test leads resistance in Continuity P/S - PE measurement is not compensated.
	Test leads resistance in Continuity P/S - PE measurement is compensated.
	Warning! A high voltage is / will be present on the instrument output! (Withstanding test voltage, Insulation test voltage, or mains voltage).
	Warning! Instrument is connected to an IT earthing / centre tapped system or PE is not connected. DO NOT USE THE INSTRUMENT IF PE FAULT!
	Warning! A very high and dangerous voltage is / will be present on the instrument output! (Withstanding test voltage).
	Test passed.
	Test failed.
	Conditions on the input terminals allow starting the measurement; consider other displayed warnings and messages.
	Conditions on the input terminals do not allow starting the measurement, consider displayed warnings and messages.
	Proceeds to next measurement step
	Stop the measurement.



Result(s) can be stored.



Starts test leads compensation in Continuity P/S - PE measurement.



Expands column in control panel.

4.5 Instrument main menu

From the instrument Main Menu different main operation menus can be selected.

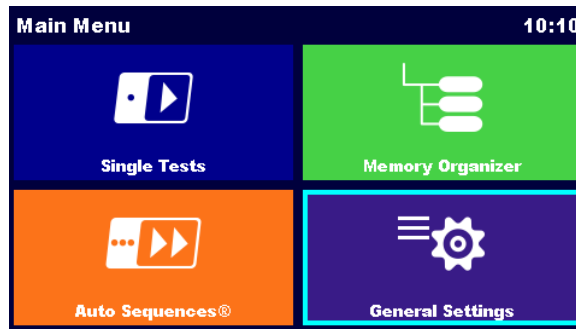

Figure 4.1: Main menu

Options



Single Tests

Menu with single tests, see chapter 6 *Single tests*.



Auto Sequences®

Menu with customized test sequences, see chapter 7 *Auto Sequences®*.



Memory Organizer

Menu for working with and documentation of test data, see chapter 5 *Memory Organizer*.



General Settings

Menu for setup of the instrument, see chapter 4.6 *General settings*.

4.6 General settings

In the General Settings menu general parameters and settings of the instrument can be viewed or set.

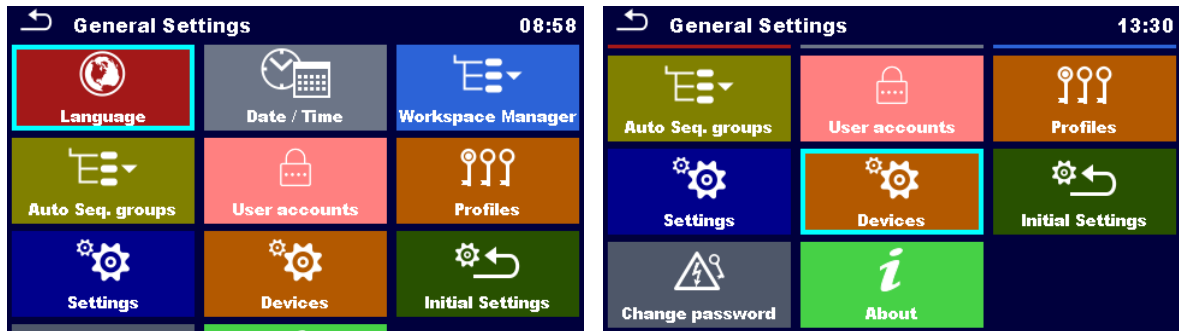











Figure 4.2: Setup menu

Options in General Settings menu

	Language Instrument language selection
	Date / Time Instruments Date and time.
	Workspace Manager Manipulation with project files. Refer to chapter 4.8 <i>Workspace Manager</i> for more information.
	Auto Sequence® groups Manipulation with lists of Auto Sequences®. Refer to chapter 4.9 <i>Auto Sequence® groups</i> for more information.
	User accounts Users settings. Refer to chapter 4.6.6 <i>User accounts</i> for more information.
	Profiles Selection of available instrument profiles.
	Settings Setting of different system parameters, including Ethernet settings.
	Devices Selection of external devices. Refer to chapter 4.6.9 <i>Devices</i> for more information.
	Bluetooth initialization Reset Bluetooth settings.
	Change password Changing password for enabling HV tests.



Initial Settings
Factory settings.



About
Instrument info.

4.6.1 Language

In this menu the language of the instrument can be set.

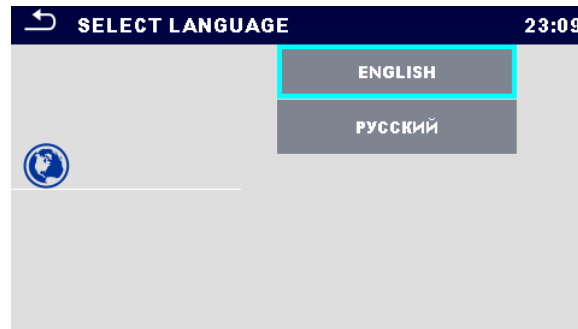

Figure 4.3: Select language menu

4.6.2 Date and time

In this menu date and time of the instrument can be set.

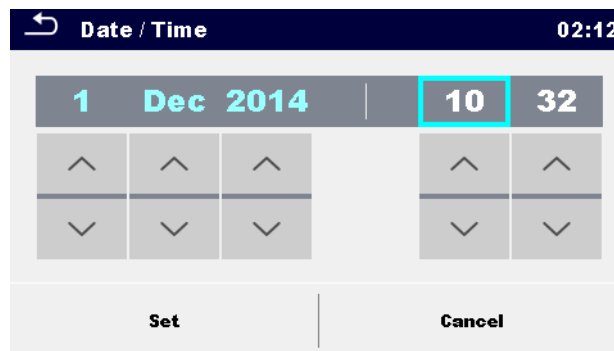

Figure 4.4: Setting data and time menu

4.6.3 Profiles

Refer to *Chapter 4.7 Instrument profiles* for more information.

4.6.4 Workspace Manager

Refer to *Chapter 4.8 Workspace Manager* for more information.

4.6.5 Auto Sequence[®] groups

Refer to *Chapter 4.9 Auto Sequence[®] groups* for more information.

4.6.6 User accounts

In this menu user accounts can be managed:

- Setting if signing in to work with the instrument is required or not.
- Adding and deleting new users, setting their user names and passwords.

The demand to sign in can prevent from unauthorized persons to work with the instrument.

If a user account is set and the user is signed in, the user's name will be stored in memory for each measurement.

The user accounts can be managed by the administrator. User account password consists of an up to 4 digit number.

Individual users can change their passwords.

The administrator password consists of an up to 15 characters. Factory set administrator password is ADMIN.

If the password is forgotten the second administrator password can be used. This password always unlocks the Account manager and is delivered with the instrument.

4.6.6.1 Signing in

By selecting User Accounts icon in Settings menu, Sign in menu appear on the screen. Same screen appear when instrument is switched on, if Sign in is set to required, see Chapter 4.6.6.3 *Managing accounts* for details.

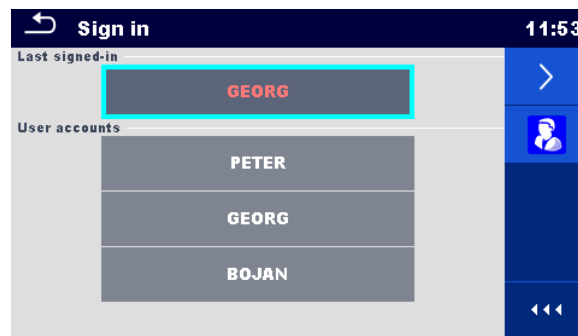
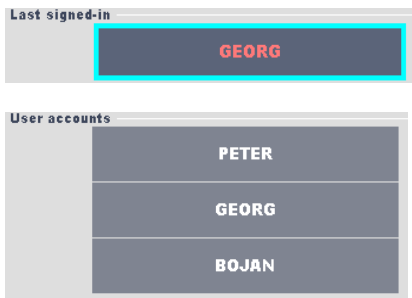

Figure 4.5: Sign in menu

Options

User signing in:





Last signed in user is highlighted and displayed in the first row.

Another user can be selected from the User accounts list.

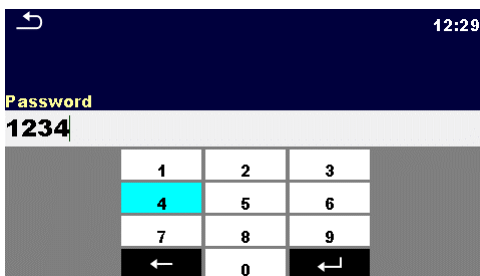

Enters User password entry screen.



Enter the User password through the on-screen numerical keyboard and confirm .

User profile screen is opened as presented on *Figure 4.6*.

Administrator signing in:



Enters Account manager password entry screen.

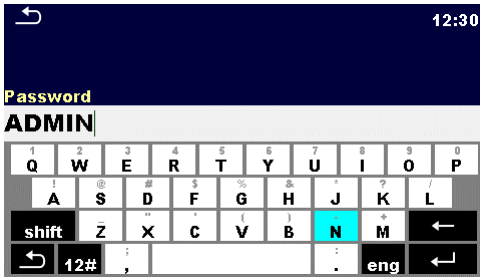

Enter the Administrator password through on-screen keyboard and confirm .

Account manager screen is opened as presented on *Figure 4.7*.

4.6.6.2 Changing user password, signing out

After user completed Sign in procedure, User profile menu screen is presented. Same screen is presented if signed in user selects User accounts from General Settings menu.



Figure 4.6: User profile menu

Options



Signed in user is displayed and highlighted on the top of the screen.



Sign out current user. Sign in screen appear, see Chapter 4.6.6.1 *Signing in* for details.



Enters Account manager password entry screen, see Chapter 4.6.6.1 *Signing in*.



Change User password. Numerical user password entry keyboard appear on the screen.

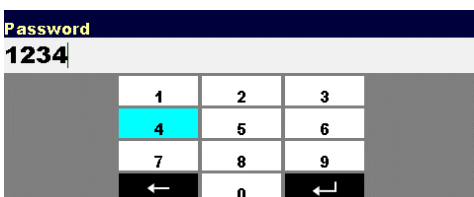

First step: enter current user password and confirm  entry.

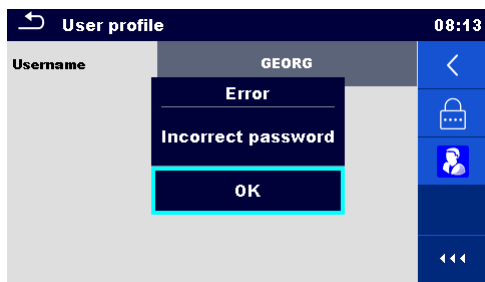

Wrong entry is reported by message. Confirm message, clear wrong password and repeat first step.

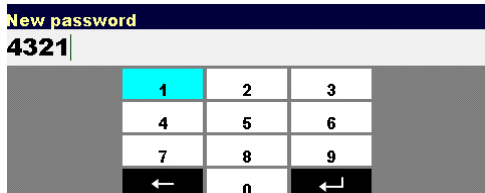

Second step: enter new user password and confirm entry. Password change is confirmed with short message appearance.

4.6.6.3 Managing accounts

To access Account manager menu, Administrator should be signed in, see Chapter 4.6.6.1 *Signing in* for details. Administrator can set sign in requirement, change Administrator password and edit user accounts. Appearance of Account manager screen depends on previous settings, see *Figure 4.7* below.

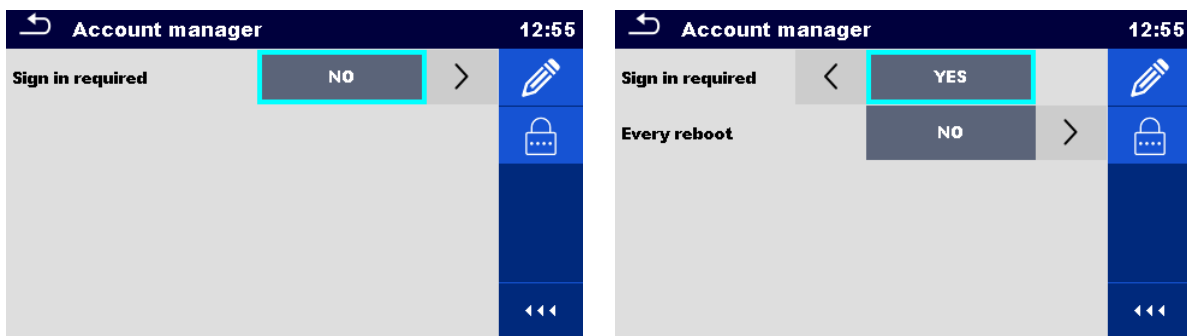



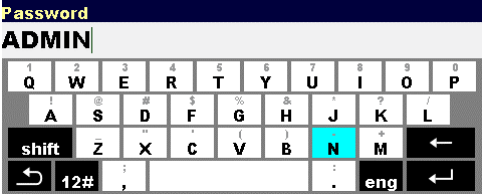

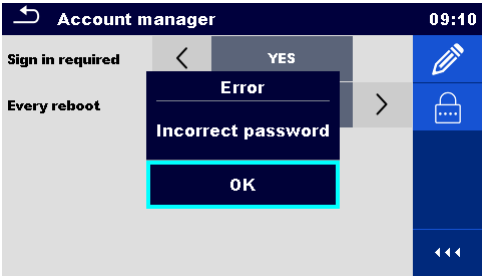
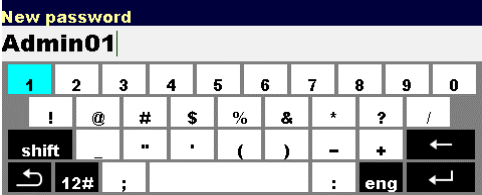



Figure 4.7: Account manager menu

Options

	<p>User sign in is not required.</p>
	<p>User sign in is required. Presented setting requires sign in, when instrument is switched on. Sign in could also be set to required on every restart of instrument.</p>
	<p>Change Administrator password. Alphanumerical keyboard appears on the screen.</p>
	<p>First step: enter current Administrator password and confirm  entry.</p>
	<p>Wrong entry is reported by message. Confirm message, clear wrong password and repeat first step.</p>
	<p>Second step: enter new Administrator password and confirm  entry. Password change is confirmed with short message appearance.</p>
	<p>Edit account icon. Enter Edit accounts screen, presented on <i>Figure 4.8</i>. For details see chapter 4.6.6.4 <i>Edit user accounts</i>.</p>

4.6.6.4 Edit user accounts

Administrator can add new user and set his password, change user existing password, delete user account and delete all user accounts.

Edit accounts screen is accessed by selecting Edit account icon from Account manager options screen, see Chapter 4.6.6.3 *Managing accounts*.

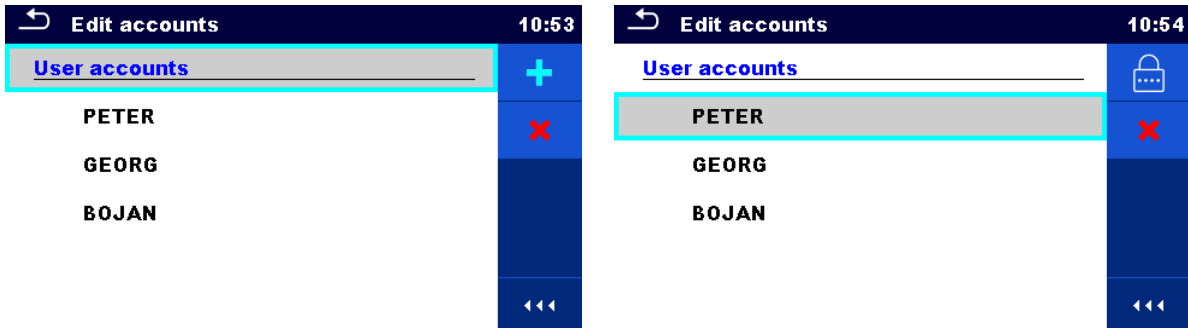

Figure 4.8: Edit accounts screen – user list on the left, user selected on the right

User accounts **User accounts** selected:

Options



Add New user account.
Add New menu appear on the screen.

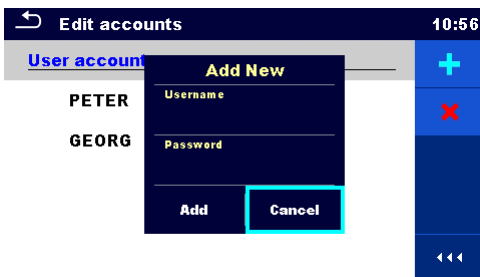

Add New selection options:

- Username opens onscreen alphanumerical keyboard for new user name entry
- Password opens onscreen numerical keyboard for new user password entry
- Add stores new user to User account list.
- Cancel interrupts procedure

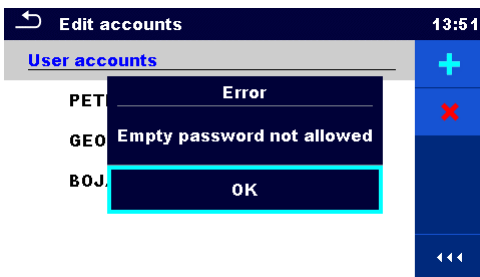

New user account password must be entered; if not, warning message appears on the screen.



Delete all user accounts.
Warning message appears on the screen.

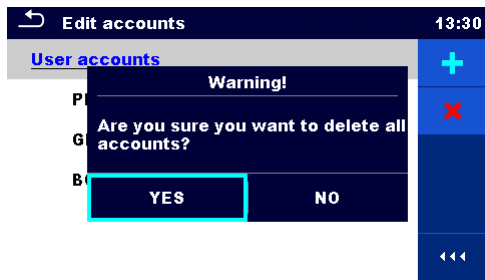

Warning message selection options:

- YES: confirmation of deletion, all user accounts will be deleted
- NO: interrupts procedure and return to Edit accounts menu

User selected (user is highlighted PETER):

Options



Set password
For selected user, password is set, numerical keyboard appears on the screen.

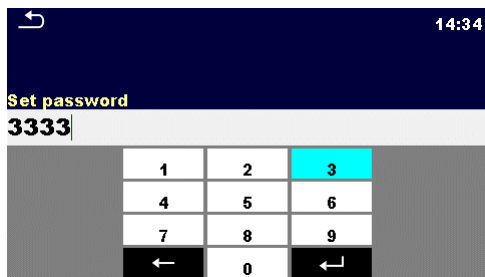

Enter user password and confirm  entry.

Old user password is automatically overwritten without warning or confirmation.



Delete selected user account.
Warning message appears on the screen.

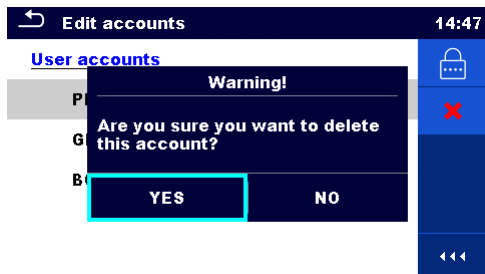

Warning message selection options:

- YES: confirmation of deletion, selected user account will be deleted
- NO: interrupts procedure and return to Edit accounts menu

4.6.7 Change password for HV functions

In this menu the password to enable starting of HV functions can be set, changed or disabled.

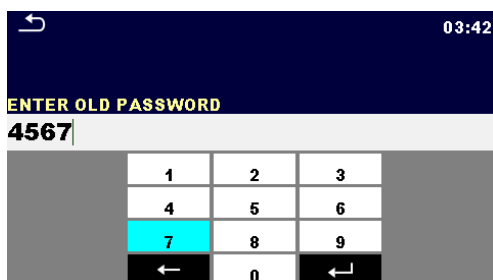

Figure 4.9: Change password menu

Notes:

- › **Default password is 0000.**
- › An empty entry disables the password.
- › If password is lost, entry 4648 resets password to default.

4.6.8 Settings

In this menu different general parameters can be set.



Figure 4.10: Settings menu

Setting options:

Option	Description
Touch screen	ON – touch screen is active. OFF – touch screen is deactivated.
Keys & touch sound	ON – sound is active. OFF – sound is deactivated.
Test mode	Standard – Visual and Functional inspection status fields should be set manually. Expert – All Visual and Functional inspection status fields are filled automatically with PASS status.
Auto Seq. flow	Ends if fail – Auto Sequence will end after first fail status of measurement / inspection is detected. Proceeding tests will be skipped. Proceeds if fail – Auto Sequence will proceed even if fail status of measurement / inspection is detected.
Result	In case the measurement consists of multiple measurements taken successively, the worst or the last result can be displayed. Worst – the worst result will be displayed at the end of test. Last – the last result will be displayed at the end of test. Notes: <ul style="list-style-type: none"> › In general, the worst result(s) of the main result is considered. Sub-result(s) taken at the same time as the worst case of the main result are displayed. › In the function Leak's & Power the worst case of Idiff and I touch are considered. The Power result measured at the time of worst Idiff is displayed. › In the function Riso, Riso-S the worst case of Riso and Riso-S are considered. The Um result measured at the time of worst Riso is displayed. › For the Power measurement the last result is considered regardless of the Result setting.
Load pretest	ON – Load pretest is enabled in Riso measurement. OFF – Load pretest is disabled.
Warning lamps	None – Lamps off; (OUTPUTS terminal disabled in single tests). HV lamps – HV warning lamps enabled in HV single tests. HV lamps + status – HV warning lamps enabled in HV single tests and pass / fail status lamps enabled in all single tests.

Pedal / Commander	ON – Pedal or Commander enabled in single tests. OFF – Pedal or Commander disabled.
Ext. Keyboard	ON – enable external BT keyboard. (See A 1578 manual for details.) OFF – external BT keyboard is disabled.

Ethernet setting options (depending on model):

Option	Available selection	Description
Obtain an IP	[AUTOMATICALLY, MANUAL]	When the manual mode is chosen, the user must provide the correct network settings. Otherwise the instrument is automatically assigned an IP address from the local network using the DHCP protocol.
IP address	XXX.XXX.XXX.XXX	Displays the instrument's IP address. In manual mode, the user should enter the correct value.
Port number	0 – 65535	Selects the port number on which the instrument listens for incoming connections. The instrument communicates using UDP/IP protocol. Max. UDP packet length is 1024 bytes.
Subnet mask	XXX.XXX.XXX.XXX	In manual mode, the user should enter the correct value.
Default gateway	XXX.XXX.XXX.XXX	In manual mode, depending on the network topology, the use can enter the correct value or leave it as it is, if not needed.
Preferred DNS server	XXX.XXX.XXX.XXX	In manual mode, depending on the network topology, the use can enter the correct value or leave it as it is, if not needed.
Alternate DNS server	XXX.XXX.XXX.XXX	In manual mode, depending on the network topology, the use can enter the correct value or leave it as it is, if not needed.
Host name	CA6165_XXXXXXXX	Displays the instrument's unique name on the local network. The host name consists of the instrument's name and its serial number.
MAC address	XX:XX:XX:XX:XX:XX	Displays the instrument's MAC address. User can change the address in case of another device on the network using the same value.

Note:

- › Instrument will reset to apply new Ethernet settings (if modified).

4.6.9 Devices

In this menu operation with external devices is configured.

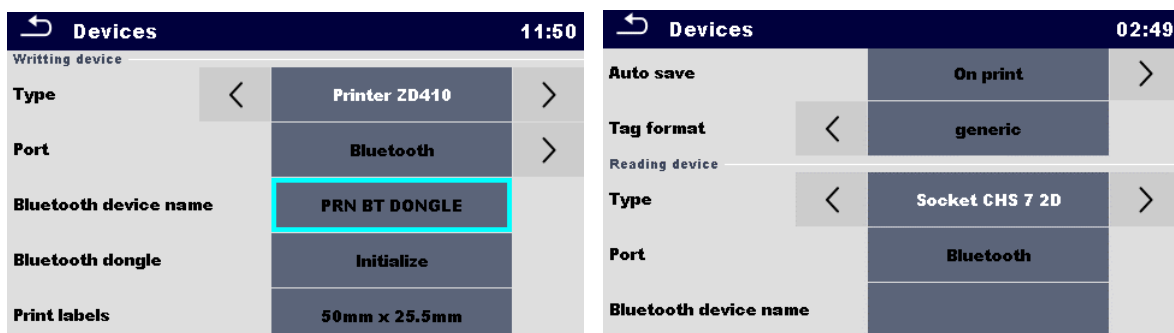

Figure 4.11: Device settings menu

Writing devices	
Type	Sets appropriate writing device (Serial printer, Bluetooth printer, RFID writer).
Port	Sets/views communication port of selected writing device.
Bluetooth device name	Goes to menu for pairing with selected Bluetooth device.
Bluetooth dongle	Initializes Bluetooth Dongle.
Print labels	Selects label form size. See <i>Appendix C - Print labels and write / read RFID / NFC tags</i> for details.
Printed date	Selects date printed on label text area, Options: [Test date, Retest date]. See <i>Appendix C - Print labels and write / read RFID / NFC tags</i> for details.
Auto save	Sets simultaneous saving of finished Auto Sequence when label is printed or RFID / NFC tag is written. Options: [On print, On write, OFF] See chapter 7.2.3 <i>Auto Sequence® result screen</i> for details.
Tag format	Sets PAT tag / label format or generic tag / label format. See <i>Appendix C - Print labels and write / read RFID / NFC tags</i> for details.
Reading devices	
Type	Sets appropriate reading device (QR or barcode scanner, RFID reader, android device via an application).
Port	Sets/views communication port of selected reading device.
Bluetooth device name	Goes to menu for pairing with selected Bluetooth device.

4.6.10 Initial Settings

In this menu internal Bluetooth module can be initialized and the instrument settings, measurement parameters and limits can be set to initial (factory) values.

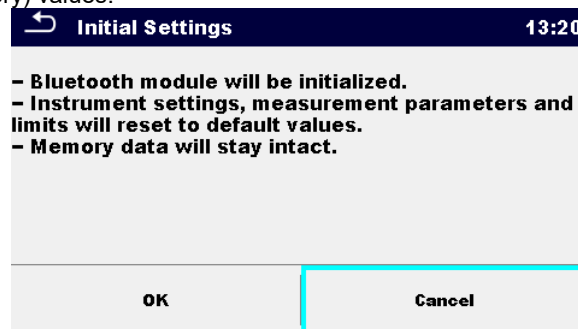

Figure 4.12: Initial settings menu

Warning!

Following customized settings will be lost when setting the instruments to initial settings:

- › Measurement limits and parameters
- › Global parameters and System settings in General settings menu

Note:

Following customized settings will stay:

- › Profile settings
- › Data in memory
- › Password for HV functions

4.6.11 About

In this menu instrument data (name, serial number, version and date of calibration) can be viewed.

About		08:52
Name	C.A 6165 APPLIANCE MULTITESTER	
S/N	23380201	
FW version	1.63.41.81220e9f	
FW Profile	ANAF	
HW version	6	
HD version	7	

Figure 4.13: Instrument info screen

4.7 Instrument profiles

In this menu the instrument profile can be selected from the available ones.

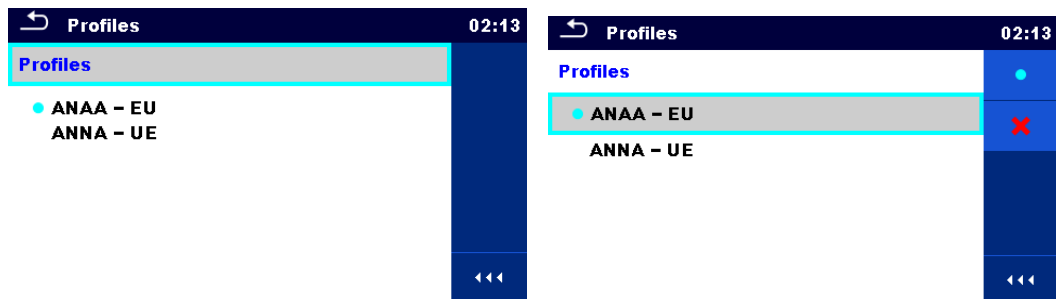

Figure 4.14: Instrument profile menu

The instrument uses different specific system and measuring settings in regard to the scope of work or country it is used. These specific settings are stored in instrument profiles.

By default each instrument has at least one profile activated. Proper licence keys must be obtained to add more profiles to the instruments.

If different profiles are available they can be selected in this menu.

Refer to *Appendix B - Profile Notes* for more information about functions specified by profiles.

Options



Loads the selected profile. The instrument will restart automatically with new profile loaded.



Enters option for deleting a profile.

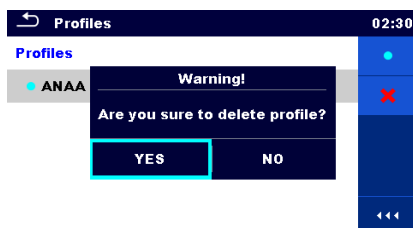

Before deleting the selected profile user is asked for confirmation.

Loaded profiles can't be deleted.

4.8 Workspace Manager

The Workspace Manager is intended to manage with different Workspaces and Exports stored on the microSD card.

4.8.1 Workspaces and Exports

The works with C.A 6165 can be organized with help of Workspaces and Exports. Exports and Workspaces contain all relevant data (measurements, parameters, limits, structure objects) of an individual work.

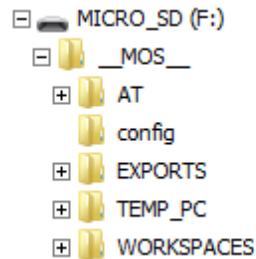

Figure 4.15: Organization of Workspaces and Exports on microSD card

Workspaces are stored on microSD card on directory WORKSPACES, while Exports are stored on directory EXPORTS. Exports are suitable for making backups of important works or can be used for storage of works if the removable microSD card is used as a mass storage device. To work on the instrument an Export should be imported first from the list of Exports and converted to a Workspace. To be stored as Export data a Workspace should be exported first from the list of Workspaces and converted to an Export.

4.8.2 Workspace Manager main menu

In Workspace manager Workspaces and Exports are displayed in two separated lists.

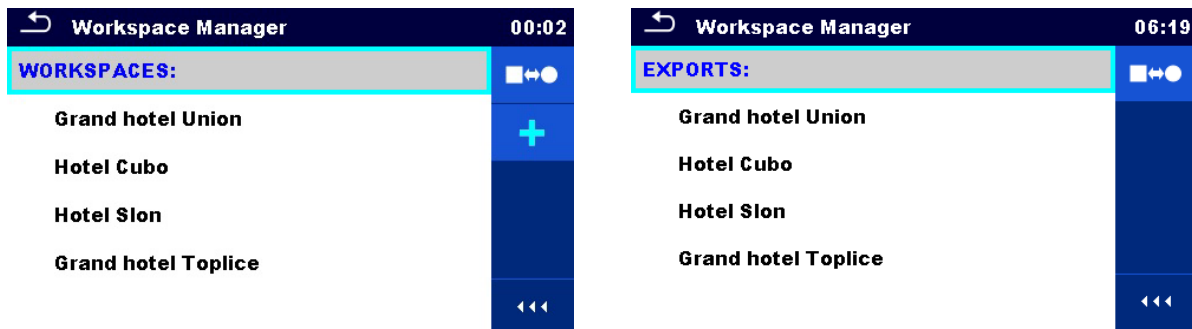

Figure 4.16: Workspace manager main menu

Options

	List of Workspaces.
	Displays a list of Exports.
	Adds a new Workspace. Refer to chapter 4.8.2.3 <i>Adding a new Workspace</i> for more information.
	List of Exports.



Displays a list of Workspaces.

4.8.2.1 Operations with Workspaces

Only one Workspace can be opened in the instrument at the same time. The Workspace selected in the Workspace Manager will be opened in the Memory Organizer.

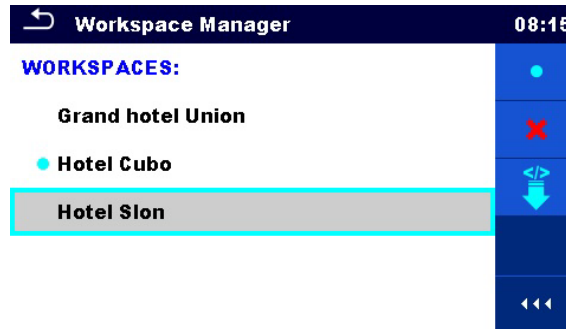
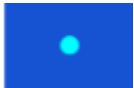

Figure 4.17: Workspaces menu

Options



Marks the opened Workspace in Memory Organizer.
Opens the selected Workspace in Memory Organizer.
Refer to chapters 5 *Memory Organizer* and 4.8.2.4 *Opening a Workspace* for more information.



Deletes the selected Workspace.
Refer to chapter 4.8.2.5 *Deleting a Workspace / Export* for more information.



Adds a new Workspace.
Refer to chapter 4.8.2.3 *Adding a new Workspace* for more information.



Exports a Workspace to an Export
Refer to chapter 4.8.2.7 *Exporting a Workspace* for more information.

4.8.2.2 Operations with Exports



Figure 4.18: Workspace manager Exports menu

Options



Deletes the selected Export.

Refer to chapter 4.8.2.5 *Deleting a Workspace / Export* for more information.



Imports a new Workspace from Export.

Refer to chapter 4.8.2.6 *Importing a Workspace* for more information.

4.8.2.3 Adding a new Workspace



New workspaces can be added from the Workspace manager screen.



Enters option for adding a new Workspace.

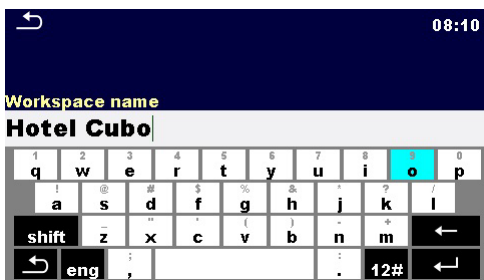

Keypad for entering name of a new Workspace is displayed after selecting New.

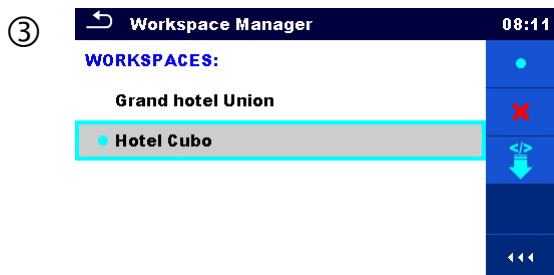

After confirmation a new Workspace is added to the list of workspaces.

4.8.2.4 Opening a Workspace



Workspace can be selected from a list in Workspace manager screen.

②



Opens a Workspace in Workspace manager.

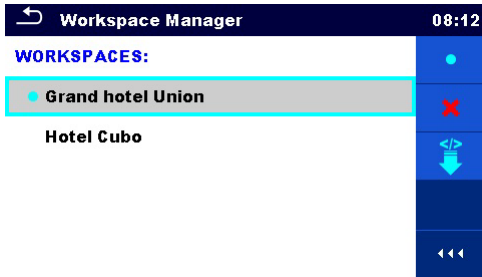

The opened Workspace is marked with a blue dot. The previously opened Workspace will close automatically.

4.8.2.5 Deleting a Workspace / Export

①

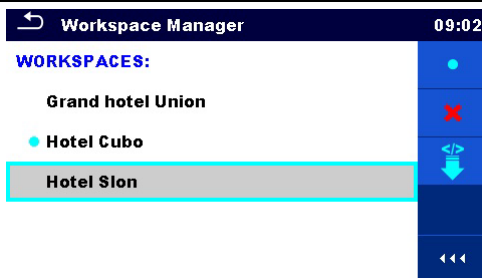

Workspace / Export to be deleted should be selected from the list of Workspaces / Exports.

②



Enters option for deleting a Workspace / Export.

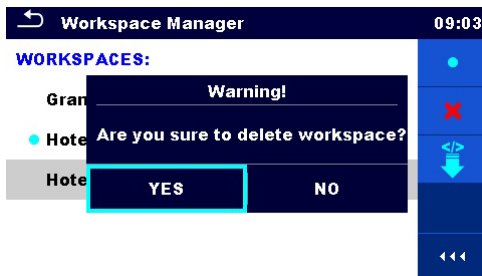



Before deleting the selected Workspace / Export the user is asked for confirmation.

③

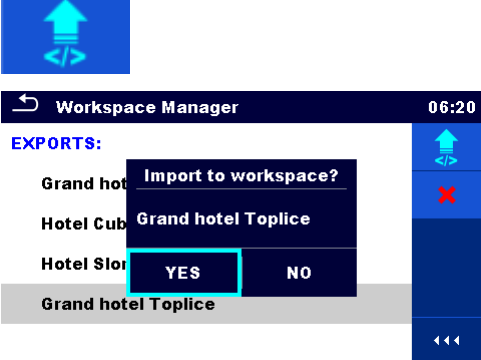

Workspace / Export is deleted from the Workspace / Export list.

4.8.2.6 Importing a Workspace

①		<p>Select an Export file to be imported from Workspace manager Export list.</p>
②		<p>Enters option Import. Before the import of the selected Export file the user is asked for confirmation.</p>
③		<p>The imported Export file is added to the list of Workspaces. Note: If a Workspace with the same name already exists the name of the imported Workspace will be changed (name_001, name_002, name_003, ...).</p>

4.8.2.7 Exporting a Workspace

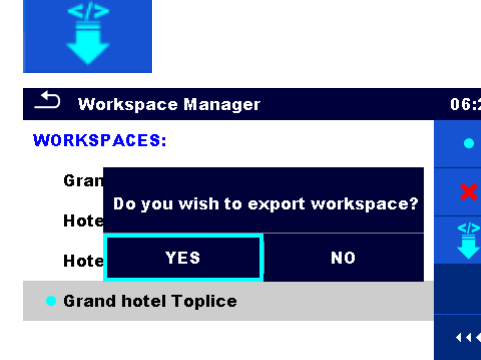
①		<p>Select a Workspace from Workspace manager list to be exported to an Export file.</p>
②		<p>Enters option for Export. Before exporting the selected Workspace the user is asked for confirmation.</p>

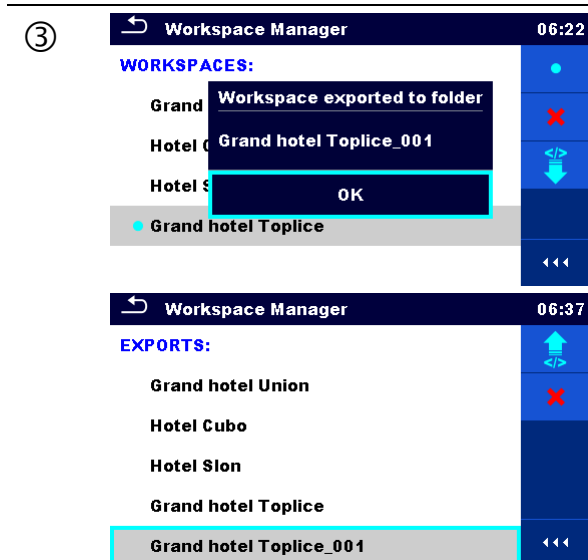

Workspace is exported to Export file and is added to the list of Exports.

Note:

If an Export file with the same name already exists the name of the Export file will be changed (name_001, name_002, name_003, ...).

4.9 Auto Sequence® groups

The Auto Sequences® in C.A 6165 are organized in Auto Sequence® groups stored in folders on the microSD memory card. Folders are located in *Root__MOS__\AT* on the microSD card.

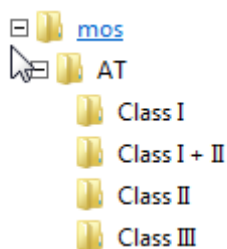

Figure 4.19: Organization of Auto Sequence® groups on microSD card

Each group contain similar Auto Sequences®. The Auto Sequence® groups menu is intended to manage with different Auto Sequences®.

4.9.1 Auto Sequence® groups menu

Auto Sequence® groups menu can be accessed from General settings menu followed by selection of Auto Sequence® groups menu.

Another option to access it is from Main Auto Sequences® menu, see chapter 7.1 *Selection of Auto Sequences®*.

In this menu lists of Auto Sequence® groups are displayed. Only one group can be active in the instrument at the same time. The group selected from the Auto Sequence® groups menu will be opened whenever Auto Sequences® menu is selected from the instrument Main menu, see chapter 4.5 *Instrument main menu*.

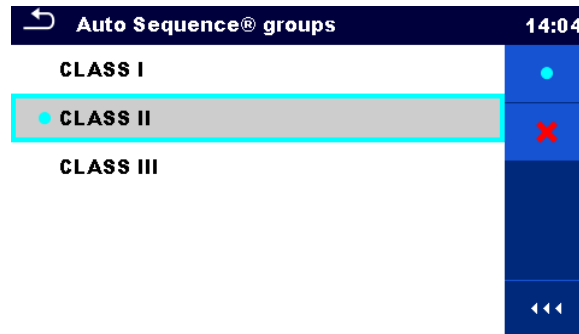

Figure 4.20: Auto Sequence® groups menu

4.9.1.1 Operations in Auto Sequence® groups menu

Options

	Opens the selected group of Auto Sequences®. Previously selected group of Auto Sequences® will be closed automatically. Refer to chapter 4.9.1.2 <i>Selecting a group of Auto Sequences®</i> for more information.
	Deletes the selected list of Auto Sequences®. Refer to chapter 4.9.1.3 <i>Deleting a group of Auto Sequences®</i> for more information.

4.9.1.2 Selecting a group of Auto Sequences®

①		A group of Auto Sequences® should be selected first from the list of Auto Sequence® groups.
②		<p>Enters option for selecting a highlighted group.</p> <p>Selected group of Auto Sequences® is marked with a blue dot.</p> <p>Note: Previously selected group is closed automatically.</p>

4.9.1.3 Deleting a group of Auto Sequences®

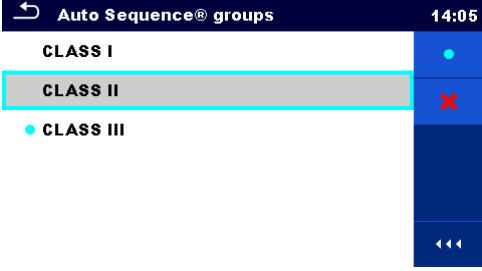
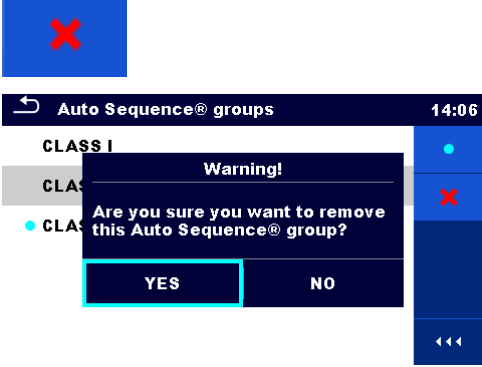
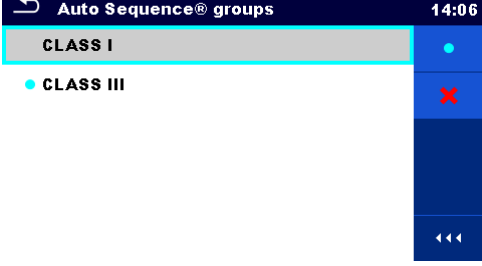
①		A group of Auto Sequences® to be deleted should be selected first from the list of Auto Sequence® groups.
②		Enters option for deleting the selected group. Before deleting the selected group of Auto Sequences®, the user is asked for confirmation.
③		A group of Auto Sequences® is deleted. Note: Selected Auto Sequences® group (marked with blue dot) cannot be deleted, warning message appear on the screen.

5 Memory Organizer

Memory Organizer is a tool for storing and working with test data.

5.1 Memory Organizer menu

The data is organized in a tree structure with Structure objects and Measurements. C.A 6165 has a fixed three level structure. The hierarchy of Structure objects in the tree is shown on *Figure 5.1*.

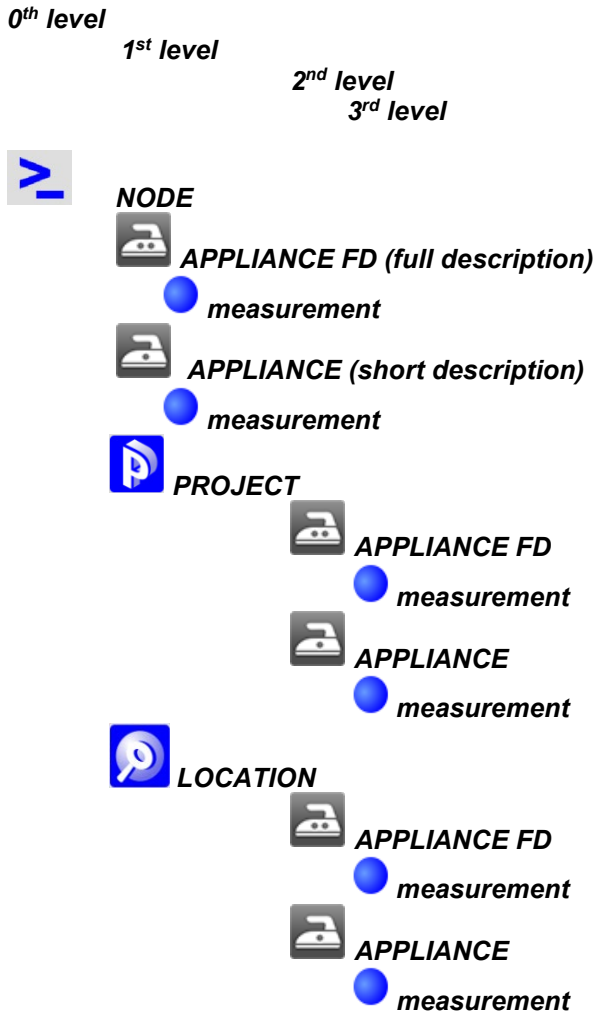

Figure 5.1: Tree structure and its hierarchy

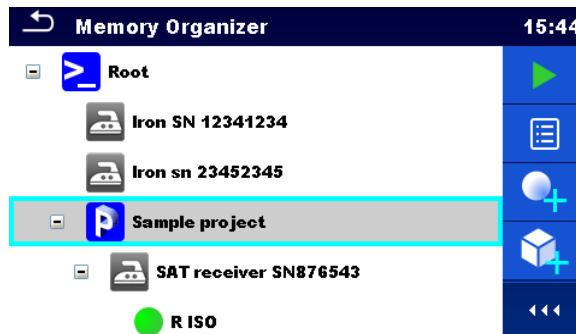





Figure 5.2: Example of a Tree menu

5.1.1 Measurement statuses









Each measurement has:

- › a status (Pass or Fail or no status)
- › a name
- › results
- › limits and parameters

A measurement can be a Single test or an Auto Sequence® test. Statuses of single tests:

- ›  passed finished single test with test results
- ›  failed finished single test with test results
- ›  finished single test with test results and no status
- ›  empty single test without test results

Overall statuses of Auto Sequence® tests:

›  or 	at least one single test in the Auto Sequence® passed and no single test failed
›  or 	at least one single test in the Auto Sequence® failed
›  or 	at least one single test in the Auto Sequence® was carried out and there were no other passed or failed single tests.
›  or 	empty Auto Sequence® with empty single tests

5.1.2 Structure Objects

Each Structure object has:

- › an icon
- › a name
- › parameters

Optionally they can have:

- › an indication of the status of the measurements under the Structure object
- › a comment or a file attached

Structure objects supported in C.A 6165 are described in *Appendix A - Structure objects in C.A 6165*.



Figure 5.3: Structure object in tree menu

5.1.2.1 Measurement status indication under the Structure object

Overall status of measurements under each structure element / sub-element can be seen without spreading tree menu. This feature is useful for quick evaluation of test status and as guidance for measurements.



There are no measurement result(s) under selected structure object. Measurements should be made.



Figure 5.4: Example of status - No measurement result(s)



One or more measurement result(s) under selected structure object has failed. Not all measurements under selected structure object have been made yet.

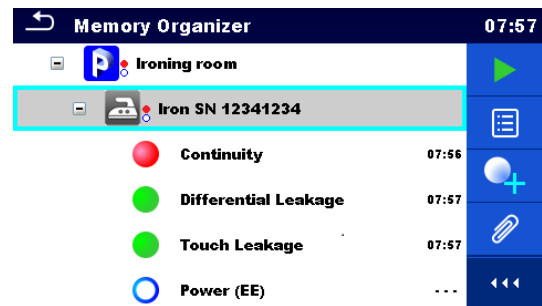

Figure 5.5: Example of status - Measurement not completed with fail result(s)



All measurements under selected structure object are completed but one or more measurement result(s) has failed.



Figure 5.6: Status - Measurements completed with fail result(s)

Note:

- There is no status indication if all measurement results under each structure element / sub-element have passed or if there is an empty structure element / sub-element (without measurements).

5.1.3 Selecting an active Workspace in Memory Organizer

Memory Organizer and Workspace Manager are interconnected so an active Workspace can be selected also in the Memory Organizer menu.

Procedure

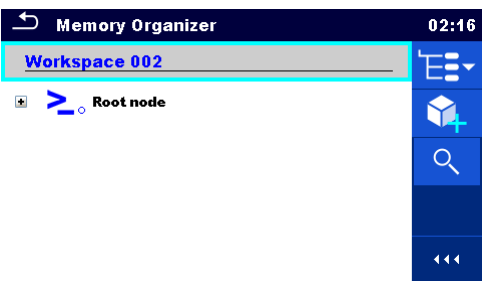
①  Press the active Workspace in Memory Organizer Menu.

②  Select List of Workspaces in Control panel.

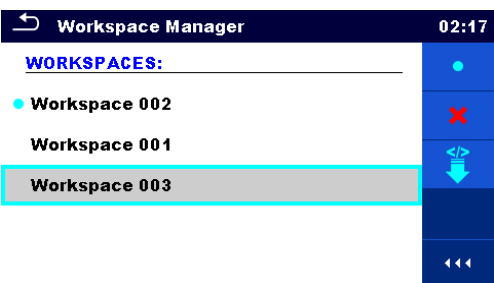
③  Choose desired Workspace from the list of Workspaces.

④  Use Select button to confirm selection.

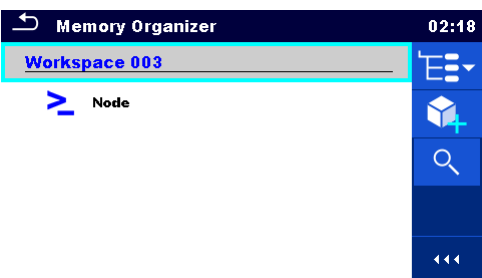
⑤  New Workspace is selected and displayed on the screen.

5.1.4 Adding Nodes in Memory Organizer

Structural Elements (Nodes) are used to ease organization of data in the Memory Organizer. One Node is a must; others are optional and can be created or deleted freely.

Procedure

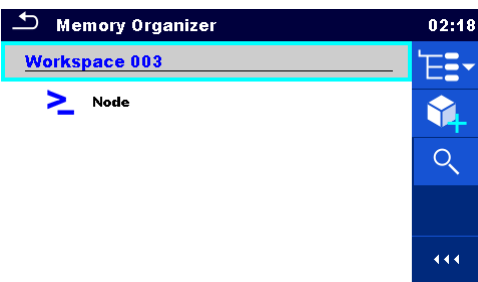
①  Press the active Workspace in Memory Organizer Menu.

②  Select Add New Structure Element in Control panel.

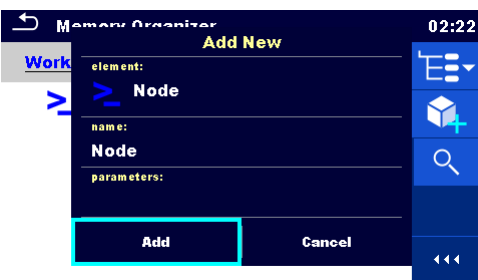
③  Change name of the Node if necessary and press Add to confirm.

④  New Structure Element (Node) will be added.

5.1.5 Operations in Tree menu

In the Memory organizer different actions can be taken with help of the control panel at the right side of the display. Possible actions depend on the selected element in the organizer.

5.1.5.1 Operations on measurements (finished or empty measurements)

The measurement must be selected first. Operation options can be selected from the menu on the right side of the screen. Menu options are adapted to measurement status, empty, finished, finished and saved, as presented on *Figure 5.7*.

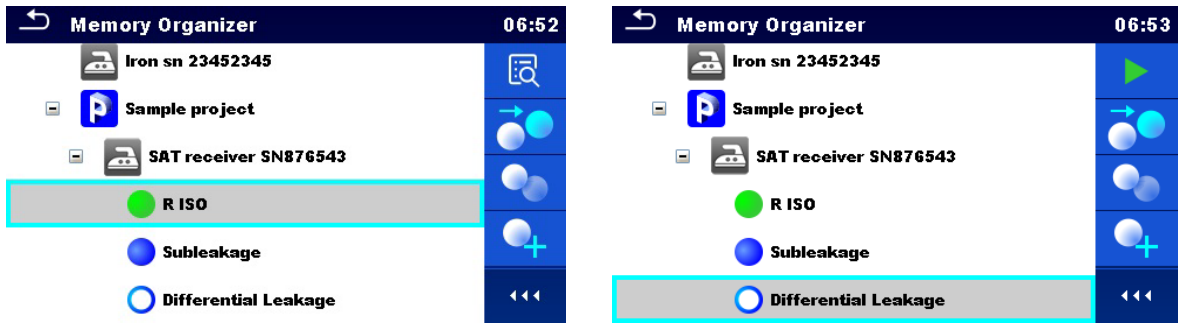









Figure 5.7: A measurement is selected in the Tree menu

Options

	Views results of measurement. The instrument goes to the measurement memory screen. Refer to chapters 6.1.1.5 <i>Single test memory screen</i> and 7.2.4 <i>Auto Sequence® memory screen</i> for more information.
	Starts a new measurement. The instrument goes to the measurement start screen. Refer to chapters 6.1.1.1 <i>Single test start screen</i> and 7.2.1 <i>Auto Sequence® view menu</i> for more information.
	Saves a measurement. Saving of measurement on a position after the selected (empty or finished) measurement.
	Clones the measurement. The selected measurement can be copied as an empty measurement under the same Structure object. Refer to chapter 5.1.5.7 <i>Clone a measurement</i> for more information.
	Copies & Paste a measurement. The selected measurement can be copied and pasted as an empty measurement to any location in structure tree. Multiple "Paste" is allowed. Refer to chapter 5.1.5.10 <i>Copy & Paste a measurement</i> for more information.
	Adds a new measurement. The instrument goes to the Menu for adding measurements. Refer to chapter 5.1.5.5 <i>Add a new measurement</i> for more information.
	Views and edit comments. The instrument displays comment attached to the selected measurement or opens keypad for entering a new comment.
	Deletes a measurement. Selected Measurement can be deleted. User is asked for confirmation before the deleting. Refer to chapter 5.1.5.12 <i>Delete a measurement</i> for more information.

5.1.5.2 Operations on Structure objects

The structure object must be selected first.

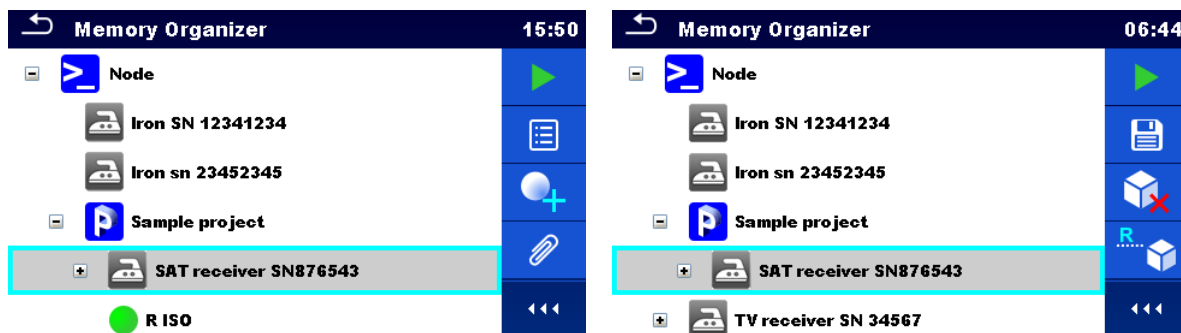











Figure 5.8: A structure object is selected in the tree menu

Options

	<p>Starts a new measurement.</p> <p>First type of measurement (Single test or Auto Sequence®) should be selected. After proper type is selected, the instrument goes to single test or Auto Sequence® selection screen. Refer to chapters 6.1 Selection of single tests and 7.1 Selection of Auto Sequences® for more information.</p>
	<p>Saves a measurement.</p> <p>Saving of measurement under the selected Structure object.</p>
	<p>View / edit parameters and attachments.</p> <p>Parameters and attachments of the Structure object can be viewed or edited. Refer to chapter 5.1.5.3 View / Edit parameters and attachments of a Structure object for more information.</p>
	<p>Adds a new measurement.</p> <p>The instrument goes to the Menu for adding measurement into structure. Refer to chapter 5.1.5.5 Add a new measurement for more information.</p>
	<p>Adds a new Structure object.</p> <p>A new Structure object can be added. Refer to chapter 5.1.5.4 Add a new Structure Object for more information.</p>
	<p>Attachments.</p> <p>Name and link of attachment is displayed.</p>
	<p>Clones a Structure object.</p> <p>Selected Structure object can be copied to same level in structure tree (clone). Refer to chapter 5.1.5.6 Clone a Structure object for more information.</p>
	<p>Copies & Paste a Structure object.</p> <p>Selected Structure object can be copied and pasted to any allowed location in structure tree. Multiple "Paste" is allowed. Refer to chapter 5.1.5.8 Copy & Paste a Structure object for more information.</p>
	<p>Views and edit comments.</p> <p>The instrument displays comment attached to the selected Structure object or opens keypad for entering a new comment.</p>
	<p>Deletes a Structure object.</p> <p>Selected Structure object and sub-elements can be deleted. User is asked for confirmation before the deleting. Refer to chapter 5.1.5.11 Delete a Structure object for more information.</p>



Renames a Structure object.

Selected Structure object can be renamed via keypad. Refer to chapter 5.1.5.13 *Rename a Structure object* for more information.

5.1.5.3 View / Edit parameters and attachments of a Structure object

The parameters and their content are displayed in this menu. To edit the selected parameter tap on it or press Enter key to enter menu for editing parameters.

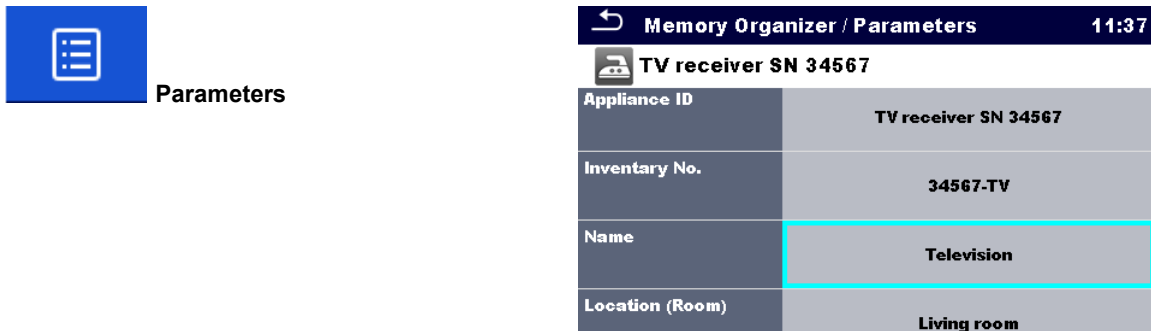
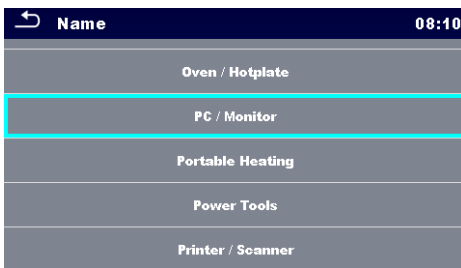
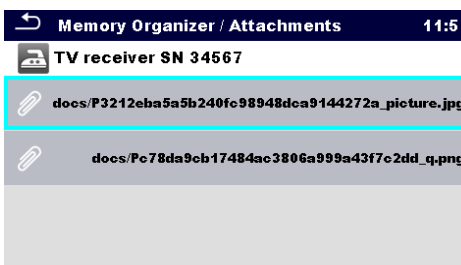
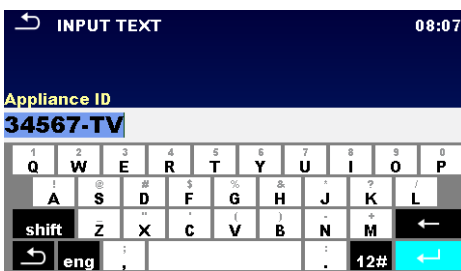

Figure 5.9: Example of View / Edit parameters menu



In menu for editing parameters the parameter's value can be selected from a dropdown list or entered via keypad. Refer to chapter 4 *Instrument operation* for more information about keypad operation.



Attachments

The name of attachment can be seen. Operation with attachments is not supported in the instrument.

5.1.5.4 Add a new Structure Object

This menu is intended to add new structure objects in the tree menu. A new structure object can be selected and then added in the tree menu.



Add Structure

Add New

element:

Project

name:

Project

parameters:

Add
Cancel

Figure 5.10: Add a new Structure Object menu

element:

Project

Element type 12:03

Project

Location

Appliance_FD

Appliance

Node

The type of Structure object to be added can be selected from dropdown menu.

Only structure objects that can be used in the same level or next sublevel are offered.

name:

Project

INPUT TEXT 08:47

Name

Project

1	2	3	4	5	6	7	8	9	0
Q	W	E	R	T	Y	U	I	O	P
!	@	#	\$	%	&	*	?	/	
A	S	D	F	G	H	J	K	L	
shift	Z	X	C	V	B	N	M	←	
↩	eng	:		.		12#	↩		

The name of the Structure object can be edited.

parameters:

Memory Organizer / Parameters 08:51

Project

None

Name (designation) of project	Project
Description (of project)	

Parameters of the Structure object can be edited.

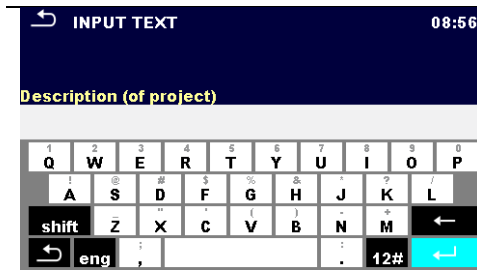

Adds the selected structure object and its parameters in the tree menu.



Returns to the tree menu without changes.

5.1.5.5 Add a new measurement

In this menu new empty measurements can be set and then added in the structure tree. The type of measurement, measurement function and its parameters are first selected and then added under the selected Structure object.

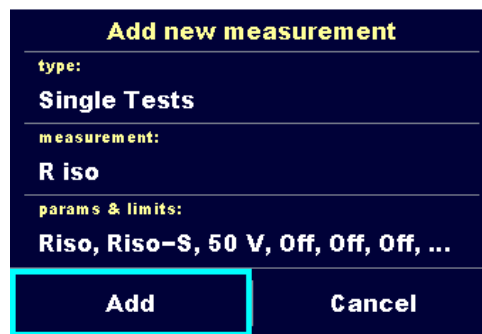

Figure 5.11: Add a new measurement menu



Type of test can be selected from this field.

Options: (Single tests, Auto Sequences®)

Tap on field or press ENTER key to modify.



Last added single test measurement is offered by default. To select another measurement press Enter to open menu for selecting measurements. Refer to chapters 6.1 Selection of single tests and 7.1 Selection of Auto Sequences® for more information



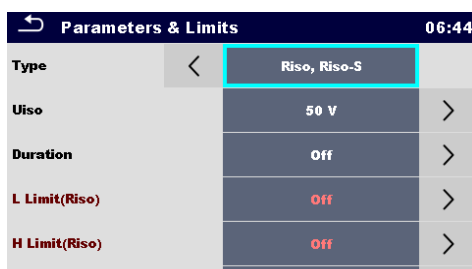

Tap on field or press ENTER key to open menu for editing parameters of the selected measurement.



Select parameter and modify it as described earlier.

Refer to chapter 6.1.1.2 Setting parameters and limits of single tests for more information.

	Add a new empty measurement. Adds the measurement under the selected Structure object in the tree menu.
	Returns to the structure tree menu without changes.

5.1.5.6 Clone a Structure object

In this menu selected structure object can be copied (cloned) to same level in the structure tree. Cloned structure object have same name as original.

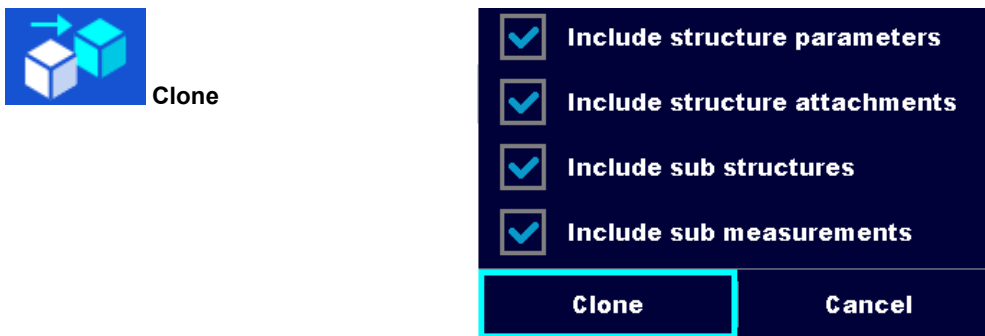
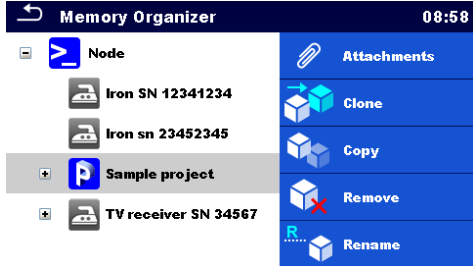

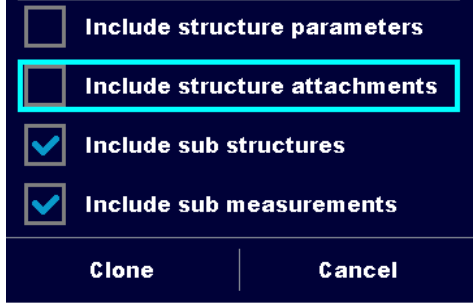



Figure 5.12: Clone Structure Object menu

Procedure and options

- ①  Select the structure object to be cloned.
- ②  Select Clone option from control panel.
- ③  The Clone Structure object menu is displayed. Sub-elements of the selected structure object can be marked or un-marked for cloning. Refer to chapter 5.1.5.9 *Cloning and Pasting sub-elements of selected structure object* for more information.
- ④  Selected structure object is copied (cloned) to same level in the structure tree.

④
b



Cloning is cancelled. No changes in the Structure tree.

⑤

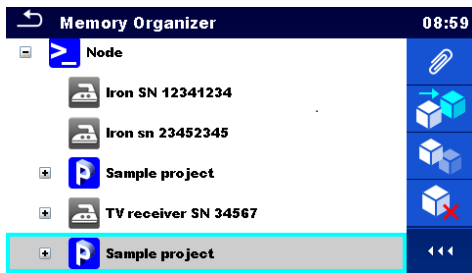



The new structure object is displayed.

5.1.5.7 Clone a measurement

By using this function a selected empty or finished measurement can be copied (cloned) as an empty measurement to the same level in the structure tree.

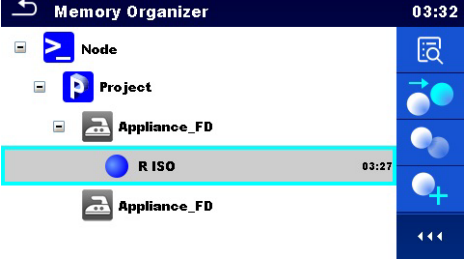

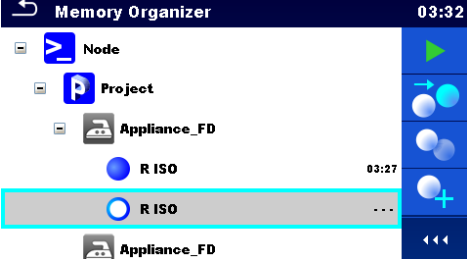
Procedure and options

<p>①</p> 	<p>Select the measurement to be cloned.</p>
<p>②</p>  <p>Clone</p>	<p>Select Clone option from control panel.</p>
<p>③</p> 	<p>The new empty measurement is displayed.</p>

5.1.5.8 Copy & Paste a Structure object

In this menu selected Structure object can be copied and pasted to any allowed location in the structure tree.

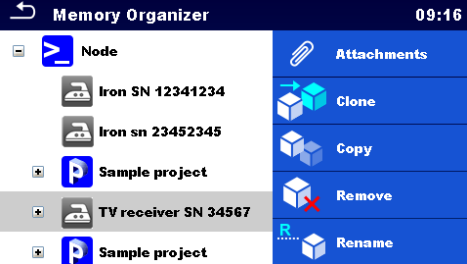
Procedure and options

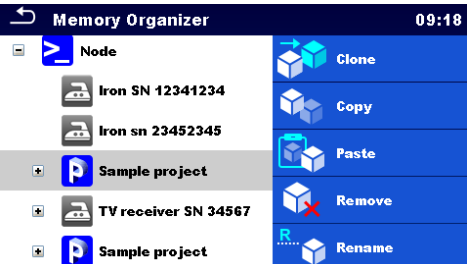
<p>①</p> 	<p>Select the structure object to be copied.</p>
<p>②</p>  <p>Copy</p>	<p>Select Copy option from control panel.</p>
<p>③</p> 	<p>Select location where structure element should be copied.</p>

④



Paste

Select Paste option from control panel.

⑤

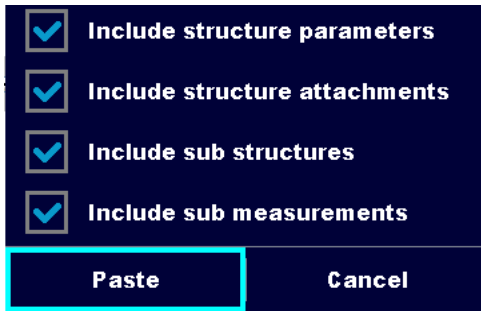

The Paste structure object menu is displayed. Before copying it can be set which sub-elements of the selected structure object will be copied too. For more details see chapter 5.1.5.9 *Cloning and Pasting sub-elements of selected structure object*.

⑥

a



The selected structure object and elements are copied (pasted) to selected position in the tree structure.

⑥

b



Returns to the tree menu without changes.

⑦

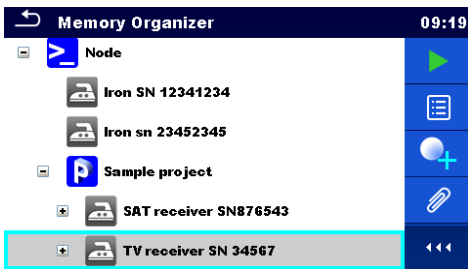

The new structure object is displayed.

Note:

The Paste command can be executed one or more times.

5.1.5.9 Cloning and Pasting sub-elements of selected structure object

When structure object is selected to be cloned, or copied & pasted, additional selection of its sub-elements is needed. The following options are available:

Options



Parameters of selected structure object will be copied too.



Attachments of selected structure object will be copied too.



Structure objects in sub-levels of selected structure object will be copied too.



Measurements in selected structure object and sub-levels will be copied too.

5.1.5.10 Copy & Paste a measurement

In this menu selected measurement can be copied to any allowed location in the structure tree.

Procedure

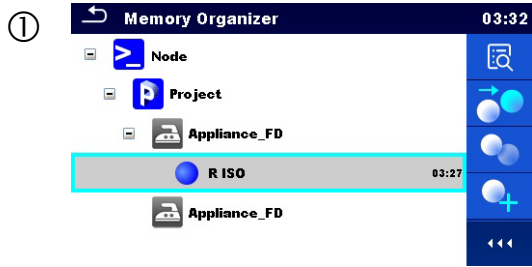

Select the structure object to be copied.



Select Copy option from control panel.

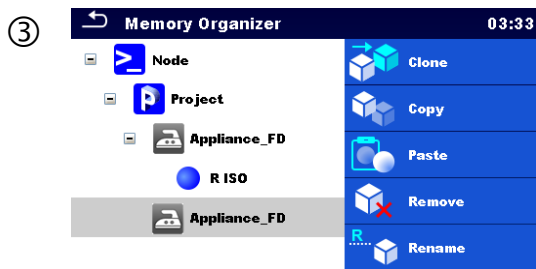

Select location where structure element should be copied.



Select Paste option from control panel.

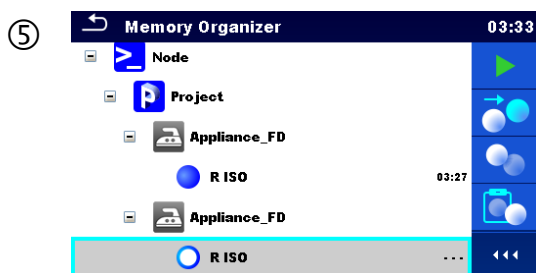

The new (empty) measurement is displayed in selected Structure object.

5.1.5.11 Delete a Structure object

In this menu selected Structure object can be deleted.

Procedure

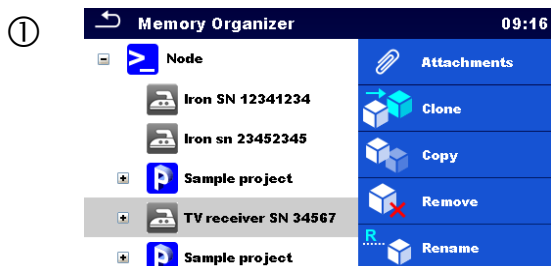

Select the structure object to be deleted.

②



Select Delete option from control panel.

③

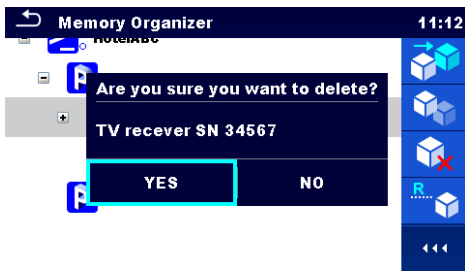

A confirmation window will appear.

④a



Selected structure object and its sub-elements are deleted.

④b



Returns to the tree menu without changes.

5.1.5.12 Delete a measurement

In this menu selected measurement can be deleted.

Procedure

①

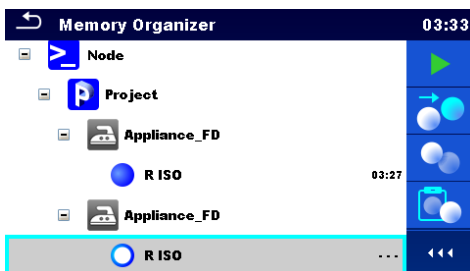

Select a measurement to be deleted.

②



Select Delete option from control panel.

③

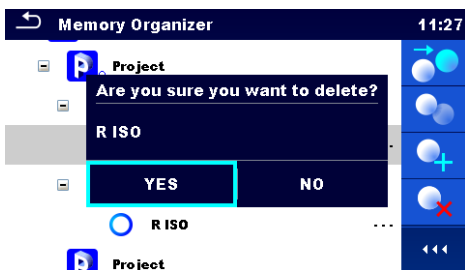

A confirmation window will appear.

④a



Selected measurement is deleted.

④b



Returns to the tree menu without changes.

5.1.5.13 Rename a Structure object

In this menu selected Structure object can be renamed.

Procedure

①

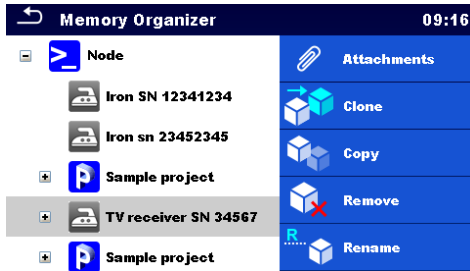

Select the structure object to be renamed.

②



Select Rename option from control panel.

③

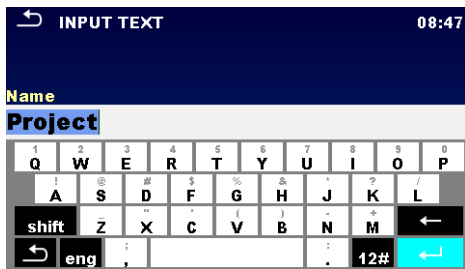

Virtual keypad will appear on screen. Enter new text and confirm.

5.1.5.14 Recall and Retest selected measurement

Procedure

①

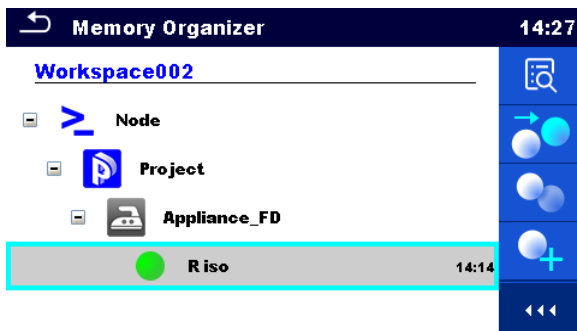

Select the measurement to be recalled.

②



Select Recall results in Control panel.

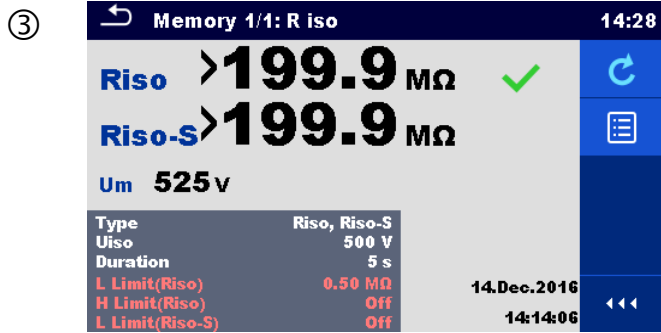

Measurement is recalled.
Parameters and limits can be viewed but cannot be edited.



Select Retest in Control panel.

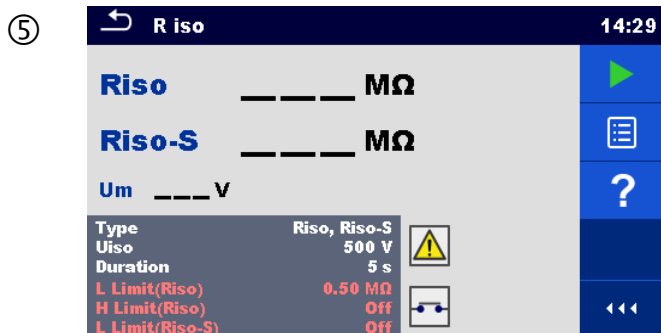

Measurement retest starting screen is displayed.

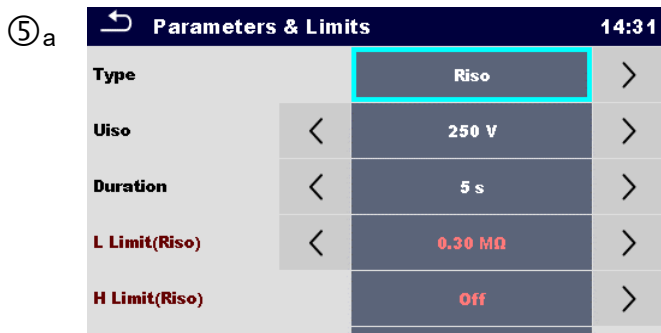

Parameters and limits can be viewed and edited.



Select Run in Control panel to retest the measurement.

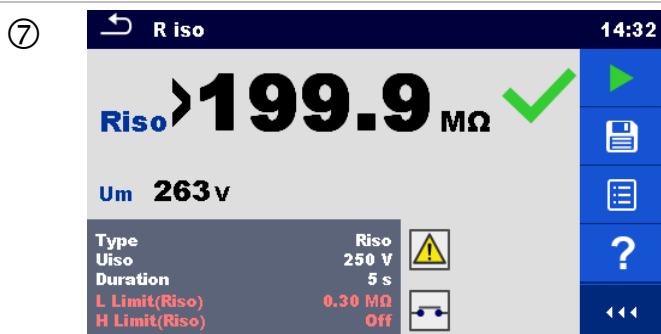

Results / sub-results after re-run of recalled measurement.



Select Save results in Control panel.

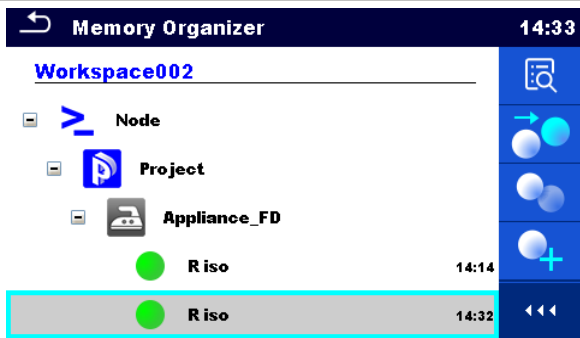

Retested measurement is saved under same structure object as original one.
Refreshed memory structure with the new performed measurement is displayed.

5.1.6 Searching in Memory Organizer

In Memory organizer it is possible to search for different structure objects and parameters.

Procedure



Search function is available from the active workspace directory line.



Select Search in control panel to open Search setup menu.

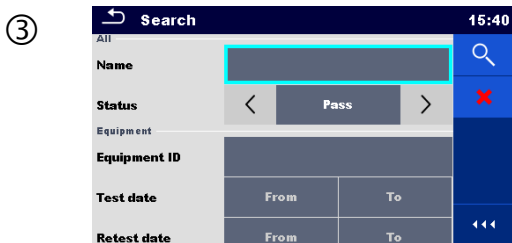

The parameters that can be searched for are displayed in the Search setup menu. Name and status are referred to all structure objects. If searching by status, instrument will display all structure objects that include one or more measurements with searched status. Equipment ID, Test date, Retest date refer only to the following structure objects: Appliance, Appliance FD, Machine and Switchgear.

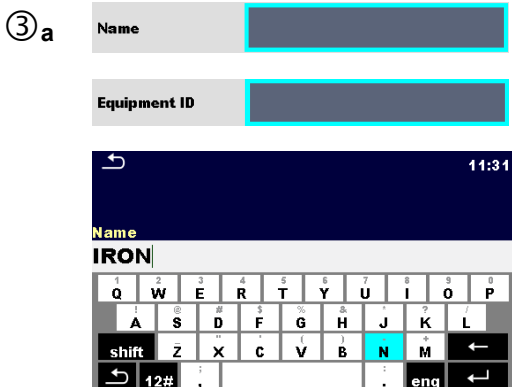

The search can be narrowed by entering a text in the Name and Equipment ID fields.

Strings can be entered using the on-screen keyboard.

Note:

The Search function on Equipment ID is case sensitive.

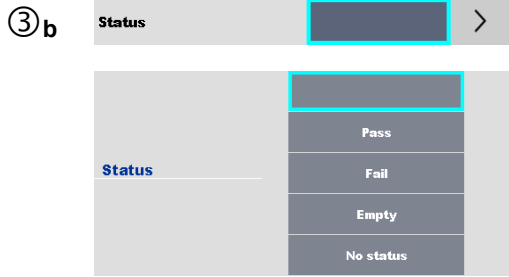

The search can be narrowed on base of statuses.

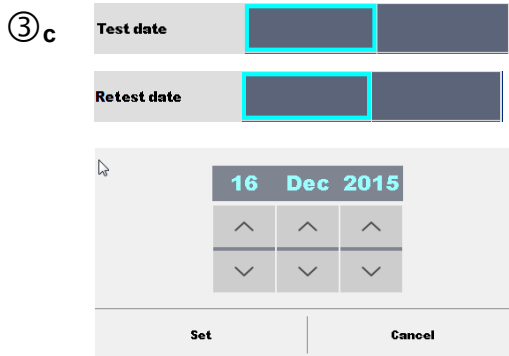

The search can be narrowed on base of test dates / retest dates (from / to).



Clear filters

Clears all filters. Sets filters to default value.



Search

Searches through the Memory Organizer for objects according to the set filters. The results are shown in the Search results screen presented on *Figure 5.13* and *Figure 5.14*.

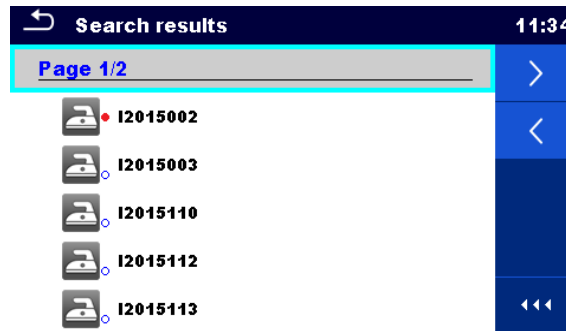

Figure 5.13: Search results screen – Page view

Options



Next page.



Previous page.

Note:

Search result page consist of up to 50 results.

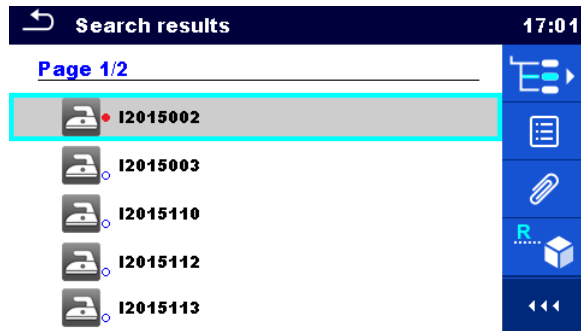

Figure 5.14: Search results screen with structure object selected

Options

	Goes to selected location in Memory Organizer.
	View / edit parameters and attachments. Parameters and attachments of the Structure object can be viewed or edited. Refer to <i>Chapter 5.1.5.3 View / Edit parameters and attachments of a Structure object</i> for more information.
	Attachments. Name and link of attachment is displayed.
	Renames the selected Structure object. Refer to <i>Chapter 5.1.5.13 Rename a Structure object</i> for more information.
	Views comment. The instrument displays comment attached to the selected Structure object.

6 Single tests

6.1 Selection of single tests

Single tests can be selected in the Main single test menu or in Memory Organizer's main and submenus. In Single test main menu there are four modes for selecting single tests.

Options



All

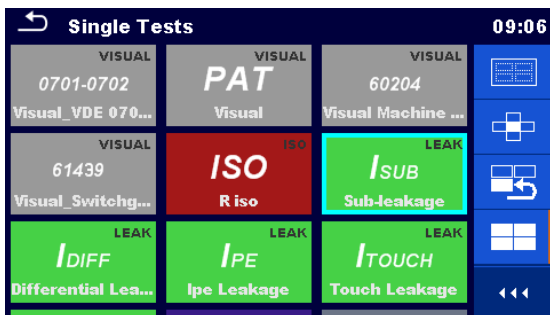

A single test can be selected from a list of all single tests. The single tests are always displayed in the same (default) order.



Last used

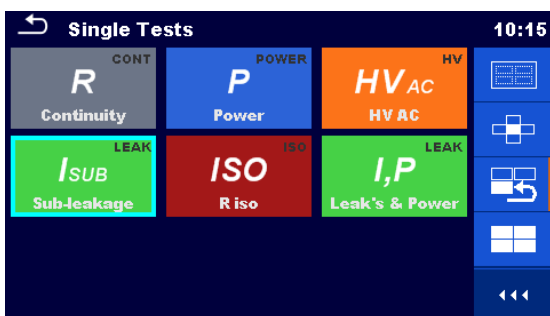

Last 9 made different single tests are displayed.



Groups

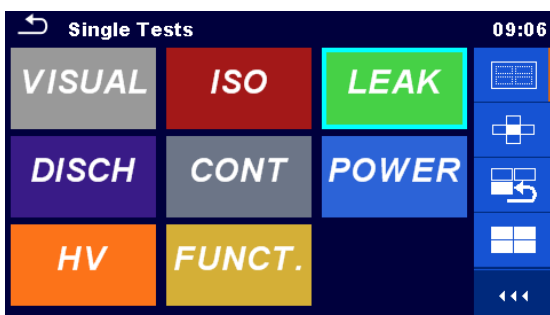

The single tests are divided into groups of similar tests.

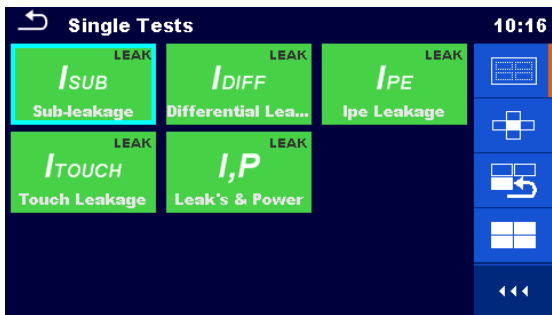

For the selected group a submenu with all single tests that belongs to the selected group is displayed.



Cross selector

This selection mode is the fastest way for working with the keypad. Groups of single tests are organized in a row.

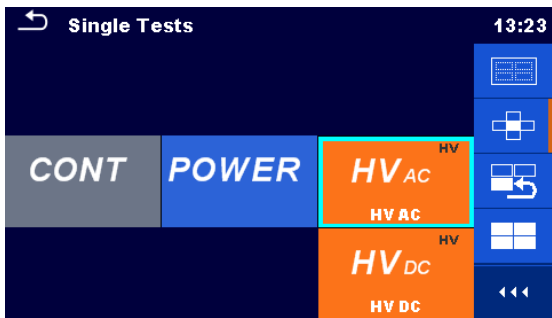
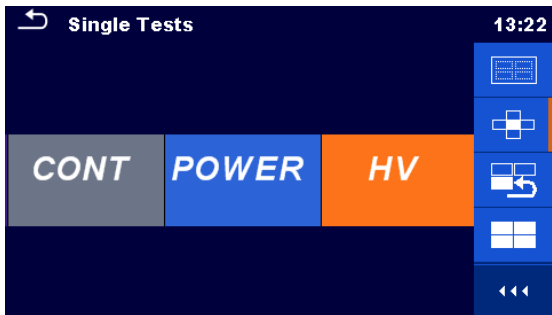

For the selected group all single tests are displayed and accessible with up/down keys.

6.1.1 Single test screens

In the Single test screens measuring results, sub-results, limits and parameters of the measurement are displayed. In addition on-line statuses, warnings and other information are displayed.

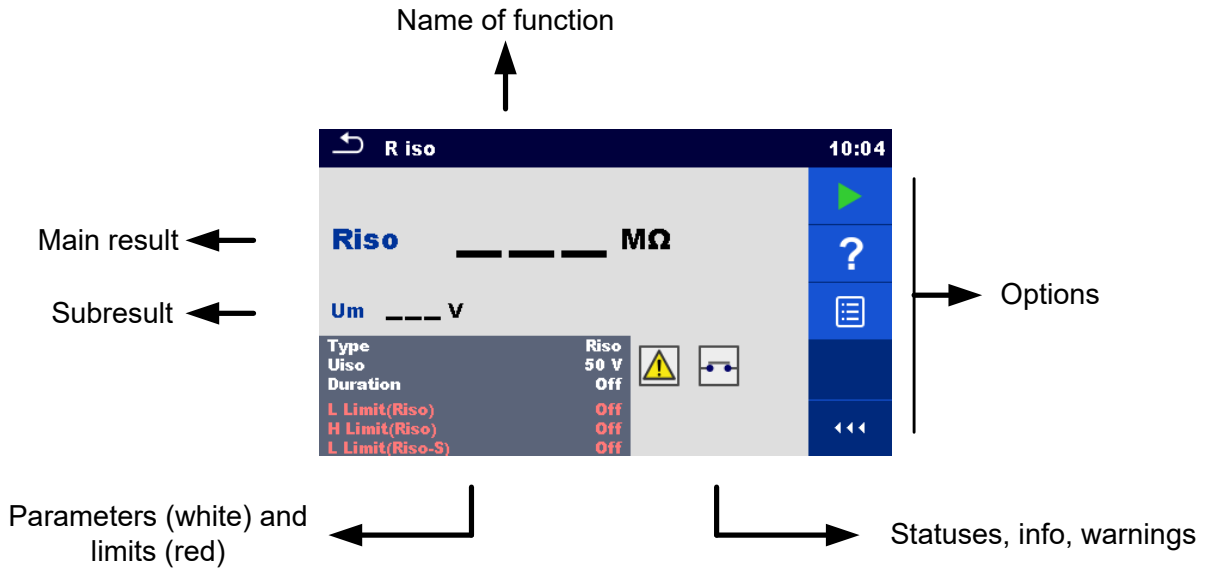

Figure 6.1: Single test screen organisation

6.1.1.1 Single test start screen

Single test screen can be opened from Memory organizer or from Single test main menu.

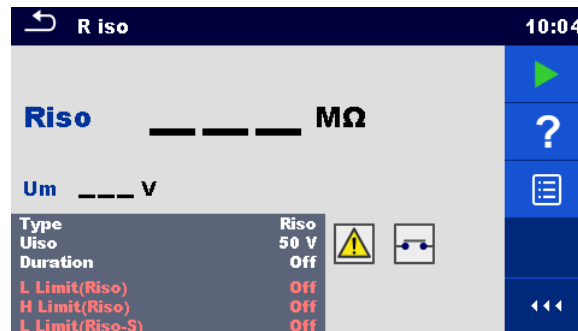



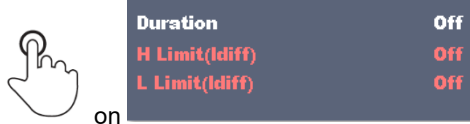

Figure 6.2: Single test start screen

Options

	Starts the measurement.
	Opens help screens. Refer to chapter 6.1.3 <i>Help screens</i> for more information.
	Opens menu for changing parameters and limits. Refer to chapter 6.1.1.2 <i>Setting parameters and limits of single tests</i> for more information.
	

6.1.1.2 Setting parameters and limits of single tests

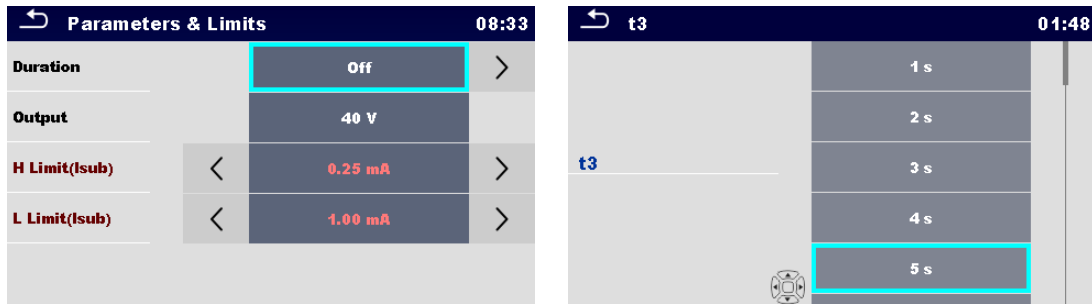

Figure 6.3: Screens in menu for setting Single test parameters and limits

Options

	<p>Selects parameter (white) or limit (red).</p>
	<p>Selects value of parameter or limit. In case of many (multiple pages of) parameters or limits:</p> <ul style="list-style-type: none"> - The scroll bar on the right side of screen can be used - With right / left keys it can be jumped page up / page down
	<p>Some of limits can be user defined. Selects Custom and tap on it.</p>
	<p>Numeric keyboard with metric prefixes will open. Enters custom limit value and confirm entry.</p>

6.1.1.3 Single test screen during test

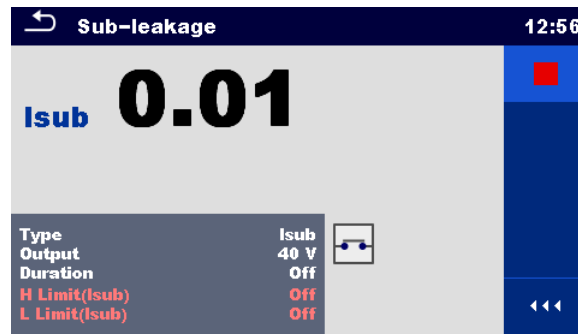





Figure 6.4: Single test screen (during measurement)

Options (during test)

	Stops the single test measurement.
	Proceeds to the next step of the measurement (if measurement consists of more steps).
	Aborts measurements.

6.1.1.4 Single test result screen

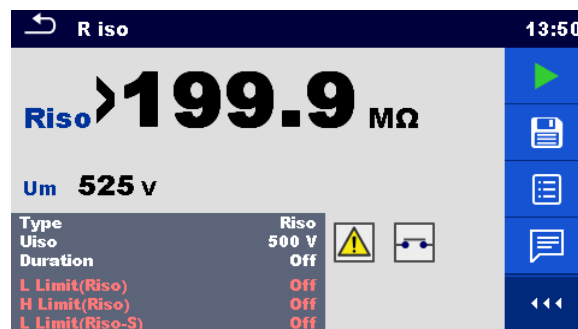



Figure 6.5: Single test result screen

Options (after measurement is finished)

	Starts a new measurement.
	Saves the result. A new measurement was selected and started from a Structure object in the structure tree: - The measurement will be saved under the selected Structure object. A new measurement was started from the Single test main menu:

- Saving under the last selected Structure object will be offered by default. The user can select another Structure object or create a new Structure object. By pressing



the key in Memory organizer menu the measurement is saved under selected location.

An empty measurement was selected in structure tree and started:

- The result(s) will be added to the measurement. The measurement will change its status from 'empty' to 'finished'.

An already carried out measurement was selected in structure tree, viewed and then restarted:

- A new measurement will be saved under the selected Structure object.



Adds comment to the measurement. The instrument opens keypad for entering a comment.



Opens help screens. Refer to chapter 6.1.3 *Help screens* for more information.



Opens screen for changing parameters and limits.

Refer to chapter 6.1.1.2 *Setting parameters and limits of single tests* for more information.



on

6.1.1.5 Single test memory screen

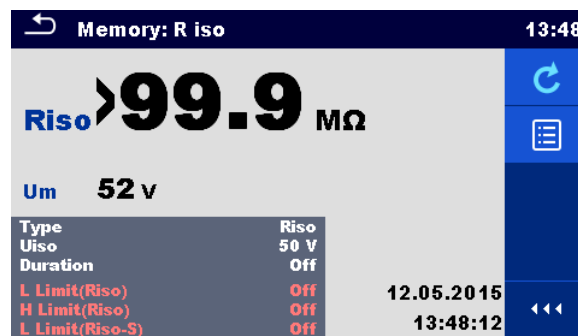

Figure 6.6: Single test memory screen

Options



Retest

Enters screen with "empty" measurement.



Opens menu for viewing parameters and limits.

Refer to chapter 6.1.1.2 *Setting parameters and limits of single tests* for more information.



on

Duration	Off
H Limit(Idiff)	Off
L Limit(Idiff)	Off

6.1.2 Single test (inspection) screens

Visual and Functional inspections can be treated as a special class of tests. Items to be visually or functionally checked are displayed. In addition on-line statuses and other information are displayed.

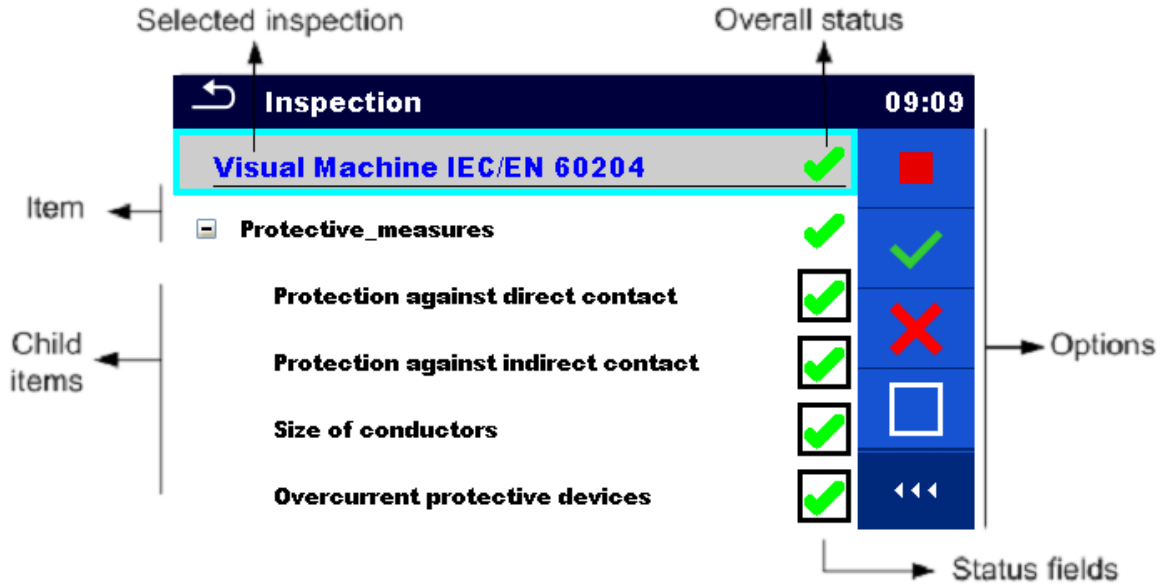

Figure 6.7: Inspection screen organisation

6.1.2.1 Single test (inspection) start screen

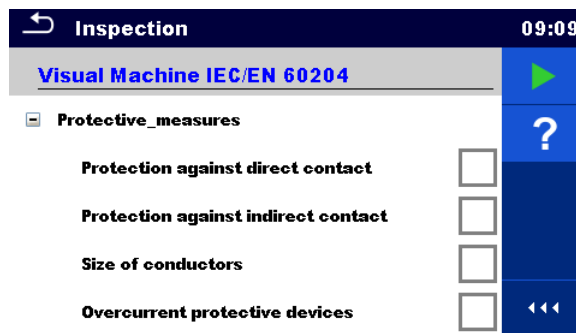

Figure 6.8: Inspection start screen

Options (inspection screen was opened in Memory organizer or from Single test main menu)



Starts the inspection



Opens help screens. Refer to chapter 6.1.3 Help screens for more information.

6.1.2.2 Single test (Inspection) screen during test

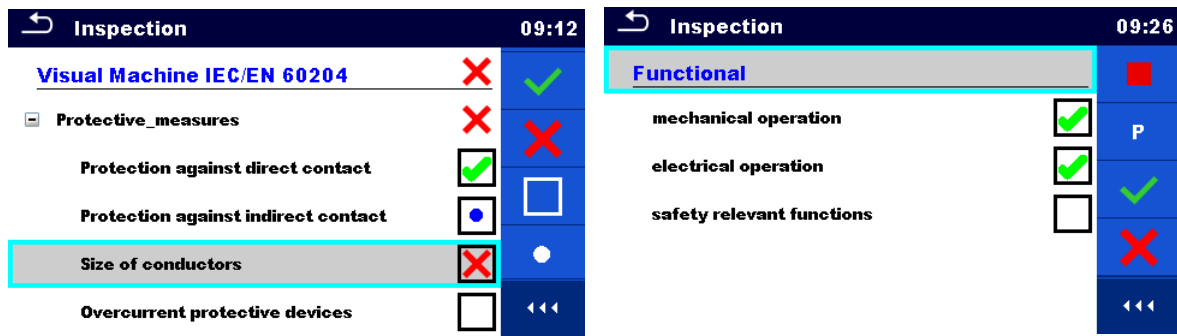

Figure 6.9: Inspection screen (during inspection)

Options (during test)

	Selects item
	Applies a pass status to the selected item or group of items.
	Applies a fail status to the selected item or group of items.
	Clears status in selected item or group of items
	Applies a checked status to the selected item or group of items.
	A status can be applied direct to the checkbox; successive tap toggle between statuses.
	Power is applied to the mains test socket to power up the tested equipment during a functional inspection. The instrument displays the Power measurement screen, refer to <i>Chapter 6.2.12 Power for details</i> .
	Stop the inspection. Enters result screen if all items are checked.
	Goes to the result screen, if inspection test running. Goes to the previous menu, if inspection test was stopped before.

Rules for automatic applying of statuses:

- The parent item(s) can automatically get a status on base of statuses in child items.

- the fail status has highest priority. A fail status for any item will result in a fail status in all parent items and an overall fail result.
 - if there is no fail status in child items the parent item will get a status only if all child items have a status.
 - Pass status has priority over checked status.
- › The child item(s) will automatically get a status on base of status in the parent item
- All child items will get the same status as applied to the parent item.

Note

- › Inspections and even inspection items inside one inspection can have different status types. For example some basic inspections don't have the 'checked' status.

6.1.2.3 Single test (Inspection) result screen

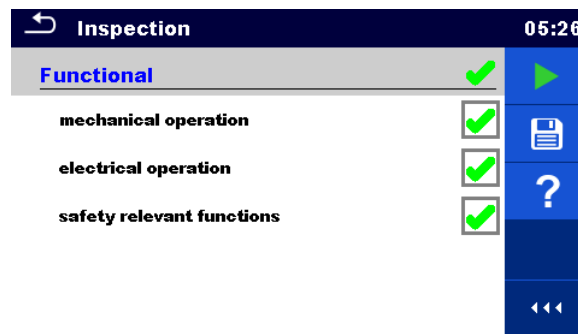



Figure 6.10: Inspection result screen

Options (after inspection is finished)

	Starts a new inspection.
	<p>Saves the result.</p> <p>A new inspection was selected and started from a Structure object in the structure tree:</p> <ul style="list-style-type: none"> - The inspection will be saved under the selected Structure object. <p>A new inspection was started from the Single test main menu:</p> <ul style="list-style-type: none"> - Saving under the last selected Structure object will be offered by default. The user can select another Structure object or create a new Structure object. By pressing the  key in Memory organizer menu the inspection is saved under selected location. <p>An empty inspection was selected in structure tree and started:</p> <ul style="list-style-type: none"> - The result(s) will be added to the inspection. The inspection will change its status from 'empty' to 'finished'. <p>An already carried out inspection was selected in structure tree, viewed and then restarted:</p> <ul style="list-style-type: none"> - A new measurement will be saved under the selected Structure object.
	Opens Help screen, see chapter 6.1.3 <i>Help screens</i> for more information.

6.1.2.4 Single test (inspection) memory screen

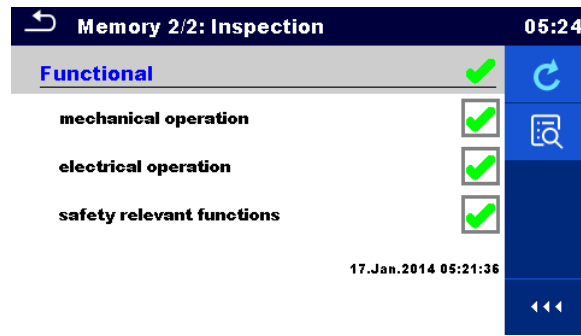

Figure 6.11: Inspection memory screen

Options



Retest

Starts inspection with cleared statuses.



Enters view mode.

6.1.3 Help screens

Help screens contain diagrams for proper connection of the instrument.

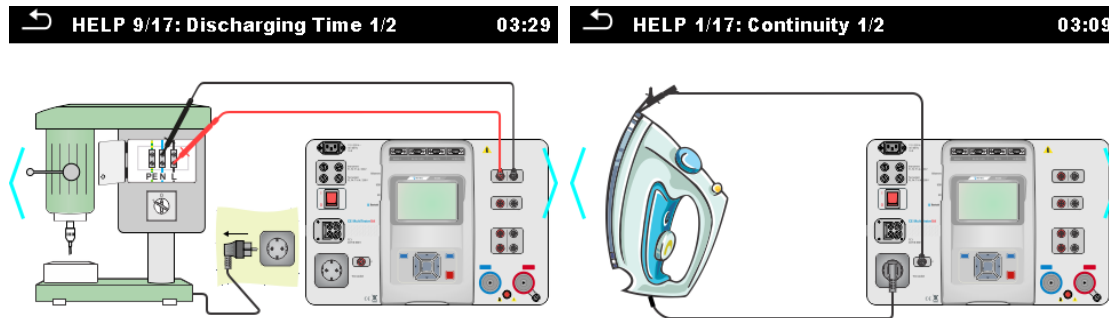
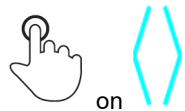

Figure 6.12: Examples of help screens

Options



Goes to previous / next help screen.

6.2 Single test measurements

6.2.1 Visual inspections

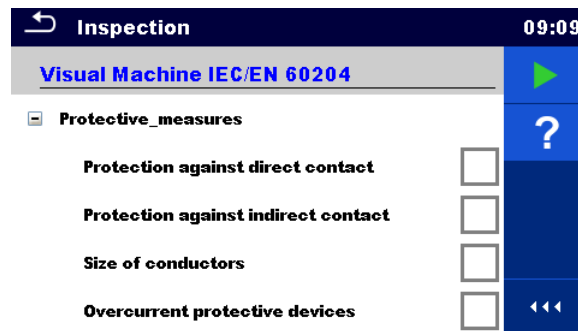

Figure 6.13: Visual inspection menu

Test circuit

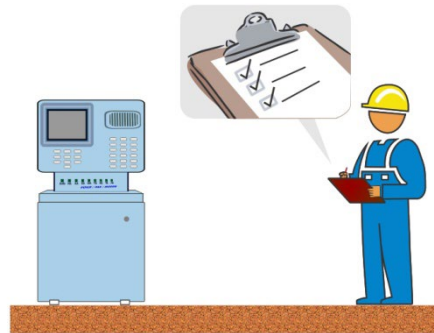

Figure 6.14: Visual inspection test circuit

Visual inspection procedure

- › Select the appropriate **Visual** inspection.
- › Start the inspection.
- › Perform the visual inspection of the appliance / equipment.
- › Apply appropriate ticker(s) to items of inspection.
- › End inspection.
- › Save results (optional).

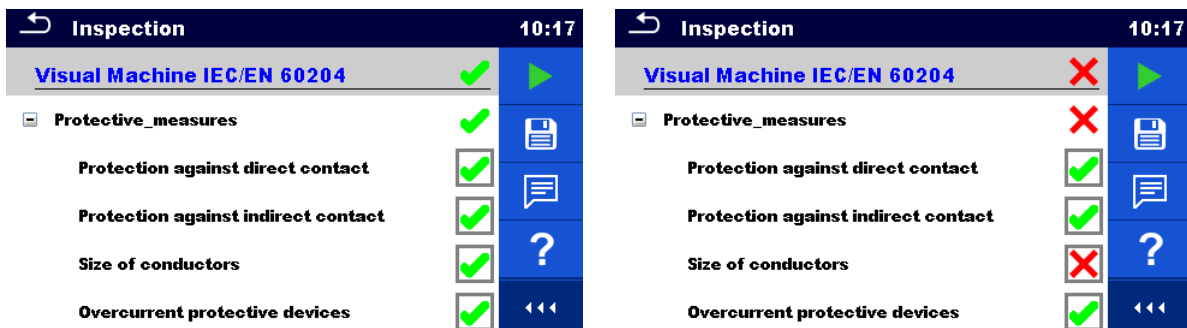

Figure 6.15: Examples of Visual inspection results

6.2.2 Continuity

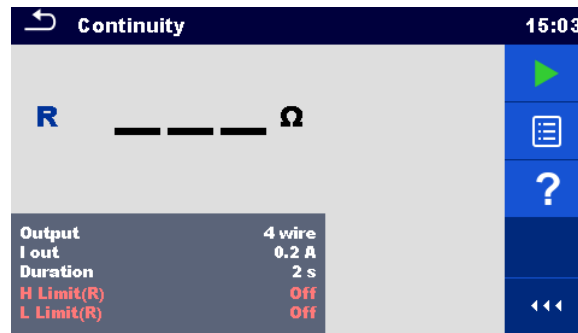

Figure 6.16: Continuity test menu

Test results / sub-results

R..... Resistance
 ΔU Voltage drop scaled to 10 A

Test parameters



Output connections	Output [4-wire, P-PE]
Test current	I out [0.2 A, 4 A, 10 A, 25 A]
Duration	Duration [Off, 2 s ... 180 s]
ΔU test*	Enables ΔU test [On, Off]
Wire section*	Wire section for ΔU test [0.5 mm ² ... \geq 6mm ²]

Test limits

H Limit (R)	H limit [Off, 0.01 Ω ... 9 Ω , Custom]
L Limit (R)	L limit [Off, 0.01 Ω ... 9 Ω , Custom]
H Limit (ΔU)*	H limit [1.0 V ... 5.0 V]

* Applicable only at test current 10 A.

Specific options

	Calibrate - Compensation of test lead resistance. Refer to chapter 6.2.2.1 for procedure details.
	Lim. Calculator – Continuity resistance H Limit(R) calculator.

Test circuit

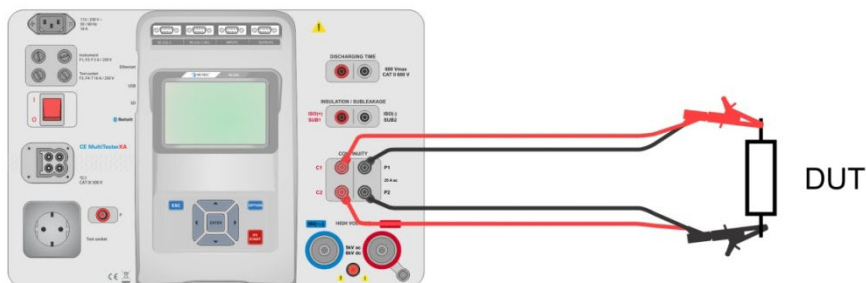

Figure 6.17: Measurement of continuity 4-wire

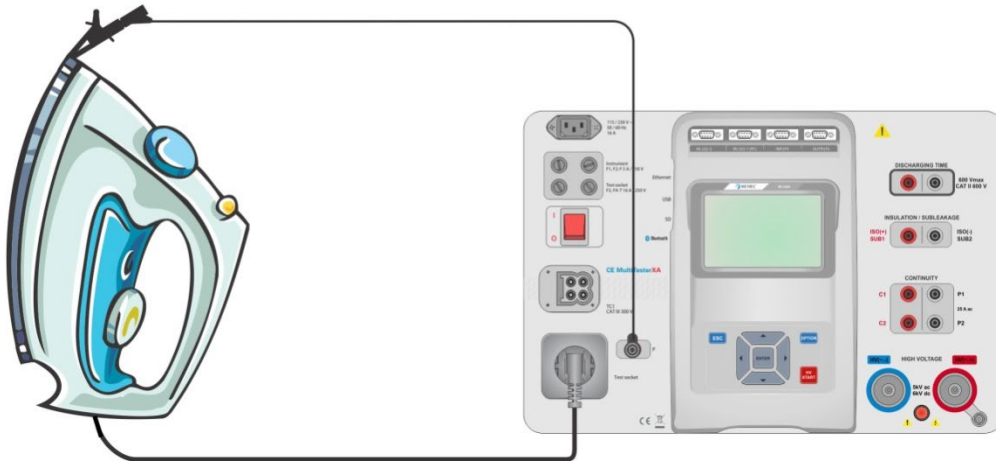

Figure 6.18: Measurement of Continuity P/S - PE

Continuity measurement procedure

- › Select the **Continuity** function.
- › Set test parameters / limits.
- › Connect test leads to C1, P1, P2 and C2 terminals on the instrument (4 wire), or connect test lead to P/S terminal (2 wire measurement P/S – PE).
- › Compensate test leads resistance (optional).
- › Connect test leads to device under test.
- › Start measurement.
- › Measurement can be stopped manually or by timer.
- › Save results (optional).

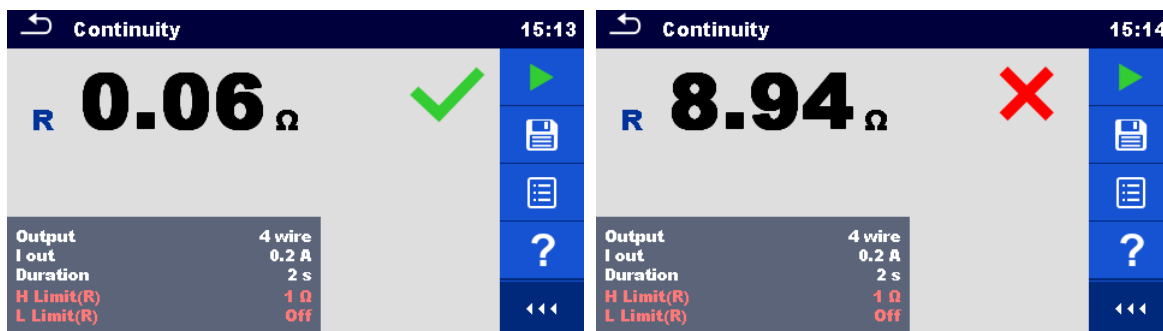

Figure 6.19: Examples of Continuity measurement results

6.2.2.1 Compensation of test leads resistance

This chapter describes how to compensate the test leads resistance in **Continuity (Output = P/S – PE)** function. Compensation can be carried out to eliminate the influence of test leads resistance and the internal resistances of the instrument on the measured resistance.

Connection for compensating the resistance of test leads

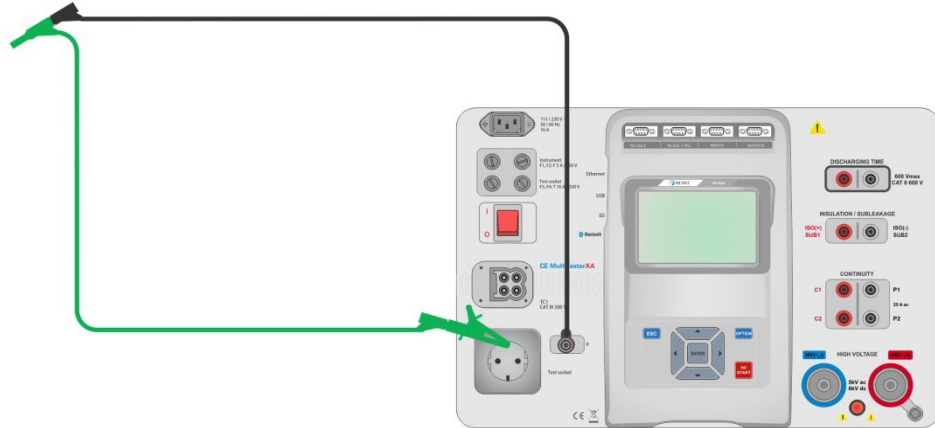



Figure 6.20: Shorted test leads

Compensation of test leads resistance procedure

- › Select the **Continuity** function. Parameter Output must be set to P/S - PE.
- › Connect test leads to the instrument and short the test leads together, see Figure 6.20.
- › Touch the  key to compensate leads resistance.
- › Symbol  is displayed if the compensation was carried out successfully.

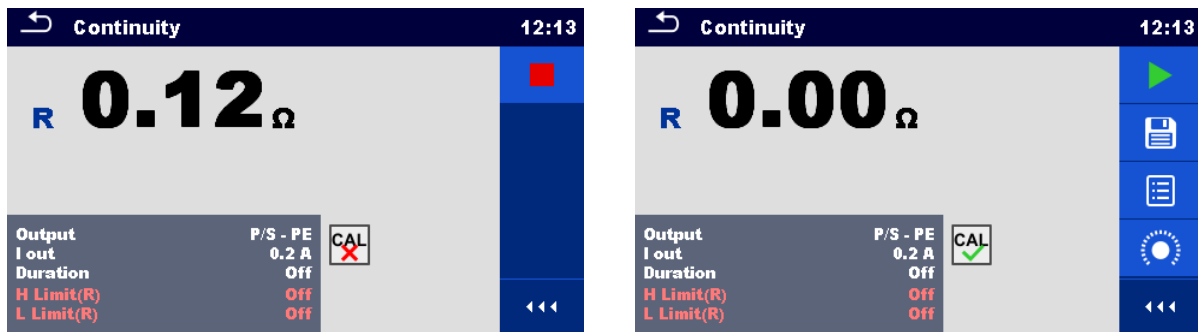

Figure 6.21: Uncompensated and compensated result

Note:

- › The compensation of test leads is carried out with set test current (I out).
- › For manual compensation in Continuity function, set R compensation parameter. Set value is decremented from the measured value. (Recommended for 4 wire Continuity measurement with 2 wire extension leads.) Max. allowed R compensation value is 2 Ω.

6.2.3 HV AC

IMPORTANT SAFETY NOTE

Refer to chapter 1.1 *Warnings and notes* for more information regarding safe use of the instrument.

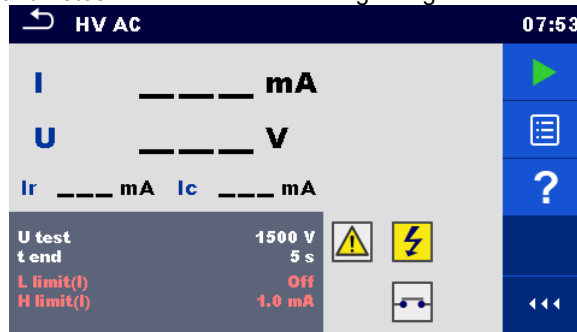

Figure 6.22: HV AC test menu

Test results / sub-results

- I test current
- U measured a.c. test voltage
- Ir resistive portion of test current
- Ic capacitive portion of test current

Test parameters

AC test voltage	U test [100 V ... 5000 V in steps of 10 V]
Duration	t end [Off, 1 s ... 120 s]

Test limits

High limit (I)	H limit [0.5 mA ... 100 mA]
Low limit (I)	L limit [Off, 0.5 mA ... 100 mA]

Test circuit

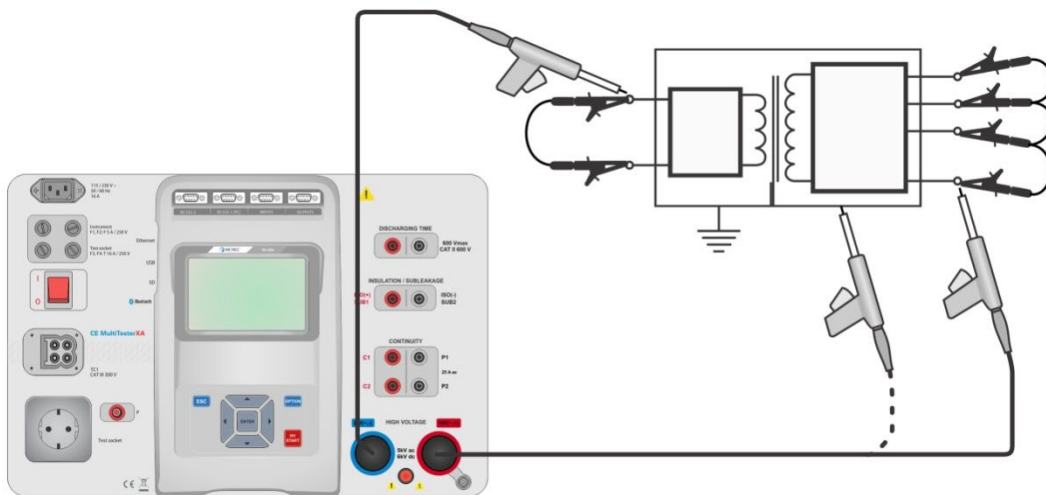

Figure 6.23: HV AC measurement

HV AC measurement procedure

- › Select the **HV AC** function.
- › Set test parameters / limits.
- › Connect HV test leads to HV(~,+) and HV(~,-) terminals on the instrument.
- › Connect HV test leads to device under test.
- › Start measurement.
- › Measurement can be stopped manually or by timer.
- › Save results (optional).

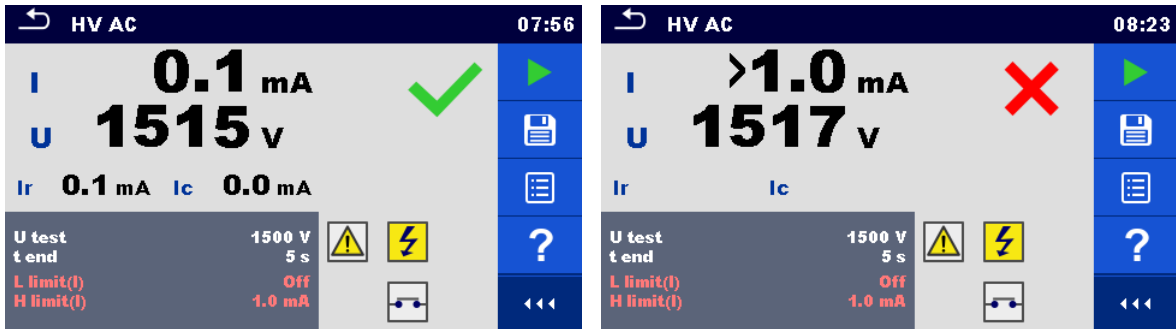

Figure 6.24: Examples of HV AC measurement results

Note:

- › First HV measurement after power on the instrument (if password protection is enabled) or first HV measurement after enabling or changing password require entering password for enabling HV test. Refer to chapter 4.6.7 *Change password for HV functions* for more information.

6.2.4 HV DC



IMPORTANT SAFETY NOTE

Refer to chapter 1.1 *Warnings and notes* for more information regarding safe use of the instrument.

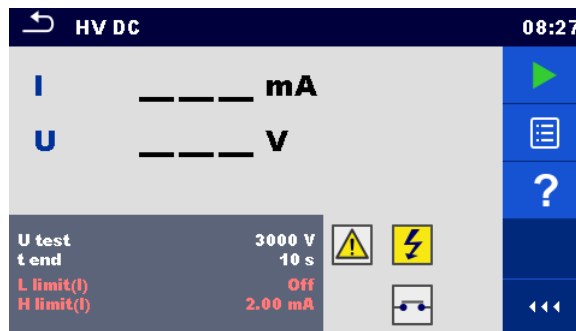

Figure 6.25: HV DC test menu

Test results / sub-results

U..... measured test voltage
 I test current

Test parameters

DC test voltage	U test [500 V ... 6000 V in steps of 50 V]
Duration	t end [Off, 1 s ... 120 s]

Test limits

High limit (I)	H limit [0.05 mA ... 10.0 mA]
Low limit (I)	L limit [Off, 0.05 mA ... 10.0 mA]

Test circuit

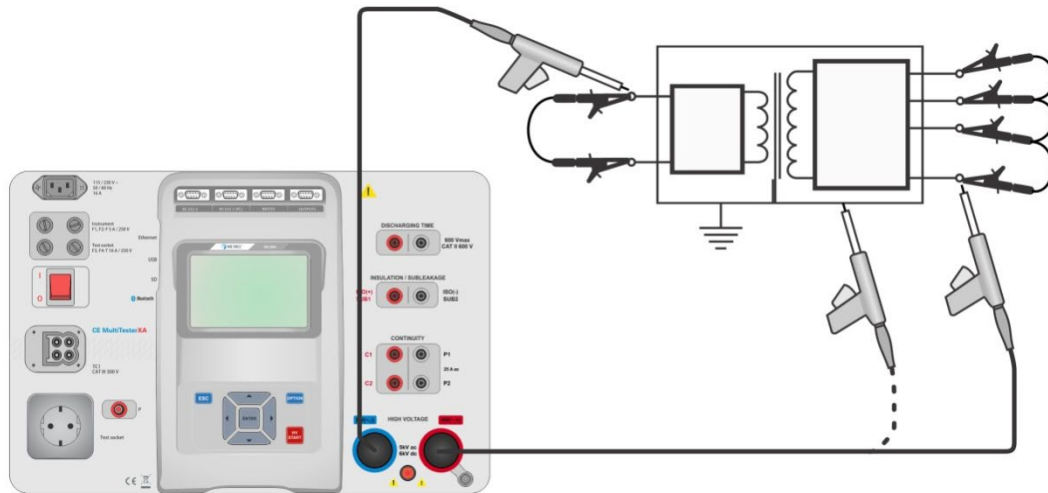

Figure 6.26: HV DC measurement

HV DC measurement procedure

- › Select the **HV DC** function.
- › Set test parameters / limits.
- › Connect HV test leads to HV(~,+) and HV(~, -) terminals on the instrument.
- › Connect HV test leads to device under test.
- › Start measurement.
- › Measurement can be stopped manually or by timer.
- › Save results (optional).

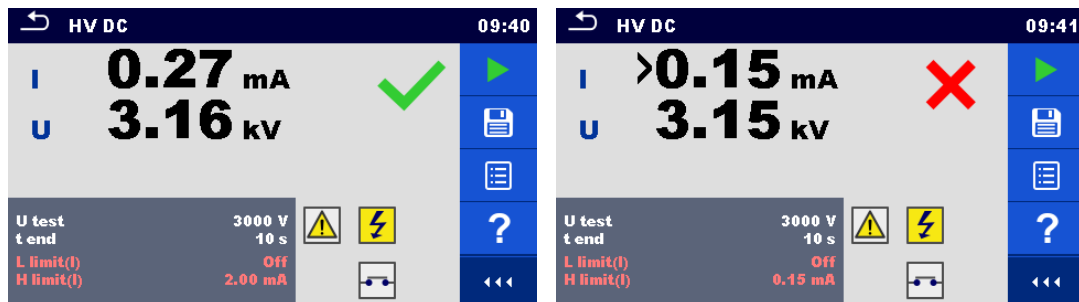

Figure 6.27: Examples of HV DC measurement results

Note:

- › First HV measurement after power on the instrument (if password protection is enabled) or first HV measurement after enabling or changing password require entering password for enabling HV test. Refer to chapter 4.6.7 *Change password for HV functions* for more information.

6.2.5 HV AC programmable



IMPORTANT SAFETY NOTE

Refer to chapter 1.1 *Warnings and notes* for more information regarding safe use of the instrument.

In the HV AC programmable test the time dependency of high voltage can be set according to diagram on *Figure 6.28*.

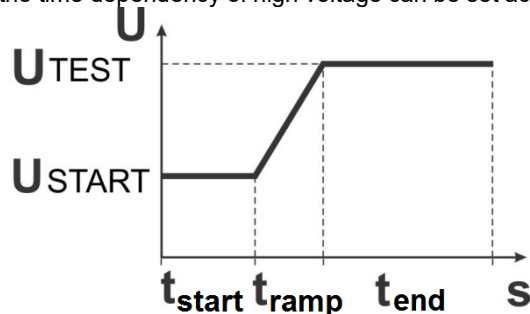

Figure 6.28: Voltage / time diagram of the HV AC programmable test

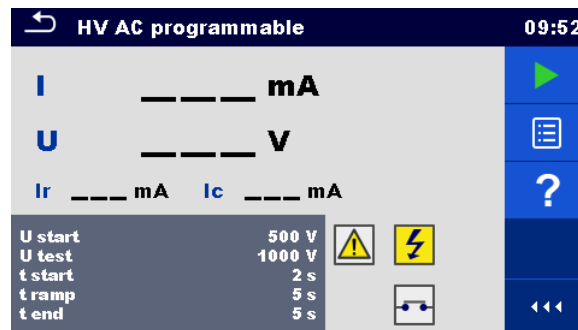

Figure 6.29: HV AC programmable test menu

Test results / sub-results

I test current
 U measured test voltage
 Ir resistive portion of test current
 Ic capacitive portion of test current

Test parameters

Starting AC test voltage	U start [100 V ... 5000 V in steps of 10 V]
AC test voltage	U test [100 V ... 5000 V in steps of 10 V]
Duration of starting voltage	t start [1 s ... 120 s]
Duration of ramp	t ramp [2 s ... 60 s]
Duration of test voltage	t end [Off, 1 s ... 120 s]

Test limits

High limit (I)	H limit [0.5 mA ... 100 mA]
Low limit (I)	L limit [Off, 0.5 mA ... 100 mA]

Test circuit

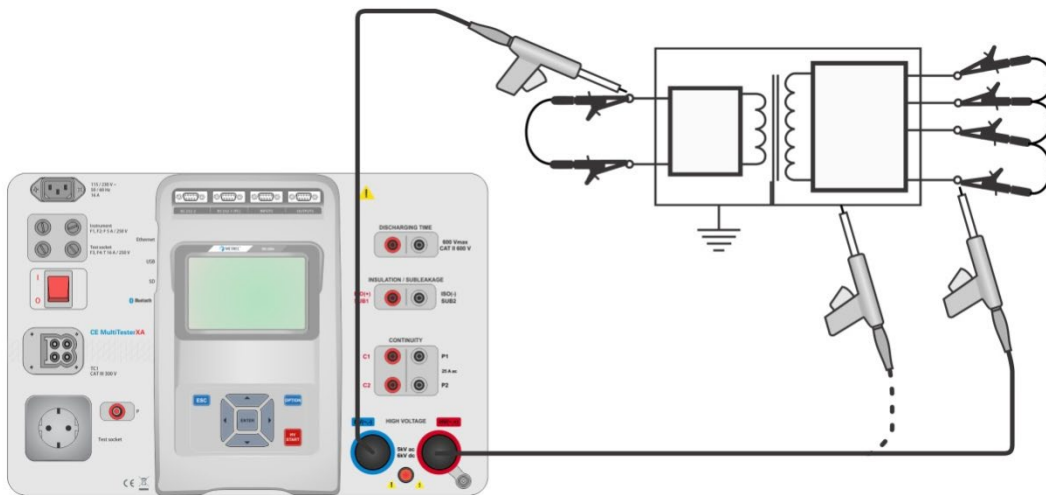

Figure 6.30: HV AC programmable test

HV AC programmable test procedure

- › Select the **HV AC programmable** function.
- › Set test parameters / limits.
- › Connect HV test leads to HV(~,+) and HV(~, -) terminals on the instrument.
- › Connect HV test leads to device under test.
- › Start measurement.
- › Measurement can be stopped manually or by timer.
- › Save results (optional).

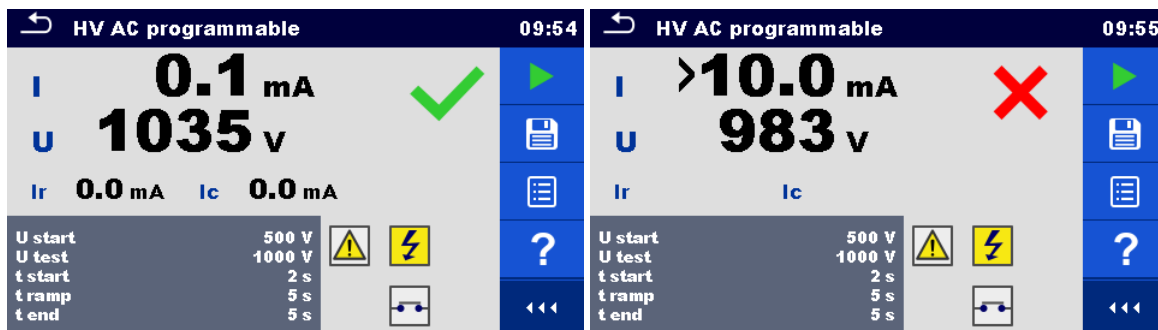

Figure 6.31: Examples of HV AC programmable test results

Note:

- › First HV measurement after power on the instrument (if password protection is enabled) or first HV measurement after enabling or changing password require entering password for enabling HV test. Refer to chapter 4.6.7 *Change password for HV functions* for more information.

6.2.6 HV DC programmable

IMPORTANT SAFETY NOTE

Refer to chapter 1.1 *Warnings and notes* for more information regarding safe use of the instrument.

In the HV DC programmable test the time dependency of high voltage can be set according to diagram on *Figure 6.28*.

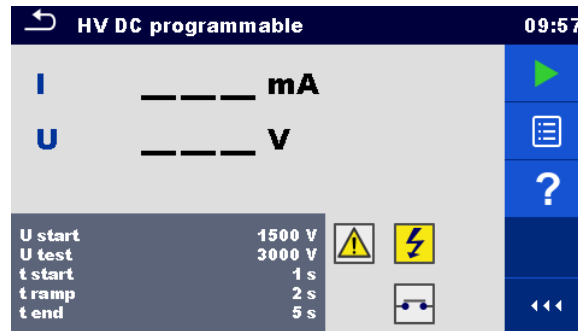

Figure 6.32: HV DC programmable test menu

Test results / sub-results

U..... measured test voltage
 I test current
 I_c capacitive portion of test current
 I_r resistive portion of test current

Test parameters

Starting DC test voltage	U start [500 V ... 6000 V in steps of 50 V]
DC test voltage	U test [500 V ... 6000 V in steps of 50 V]
Duration of starting voltage	t start [1 s ... 120 s]
Duration of ramp	t ramp [2 s ... 60 s]
Duration of test voltage	t end [Off, 1 s ... 120 s]

Test limits

High limit (I)	H limit [0.05 mA ... 10.0 mA]
Low limit (I)	L limit [Off, 0.05 mA ... 10.0 mA]

Test circuit

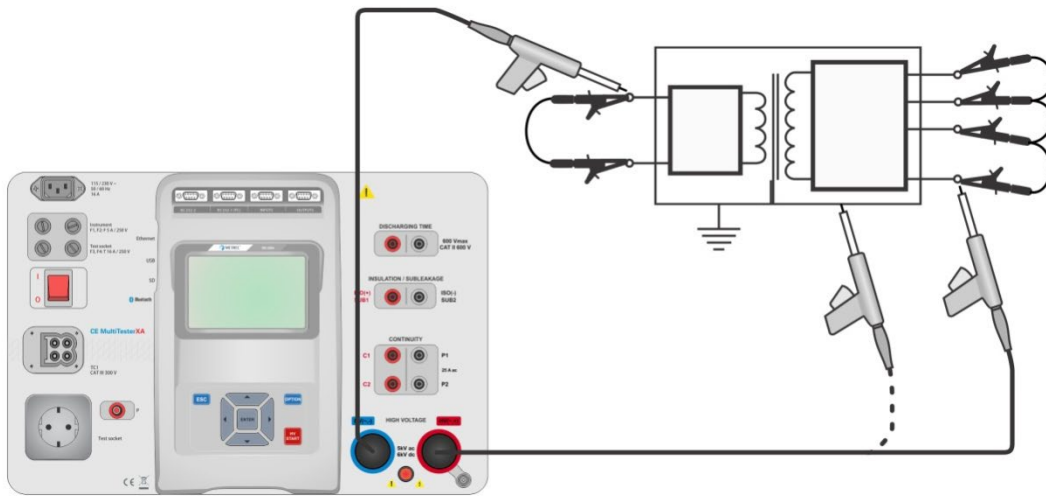

Figure 6.33: HV DC programmable test

HV DC programmable test procedure

- › Select the **HV DC programmable** function.
- › Set test parameters / limits.
- › Connect HV test leads to HV(~,+) and HV(~, -) terminals on the instrument.
- › Connect HV test leads to device under test.
- › Start measurement.
- › Measurement can be stopped manually or by timer.
- › Save results (optional).

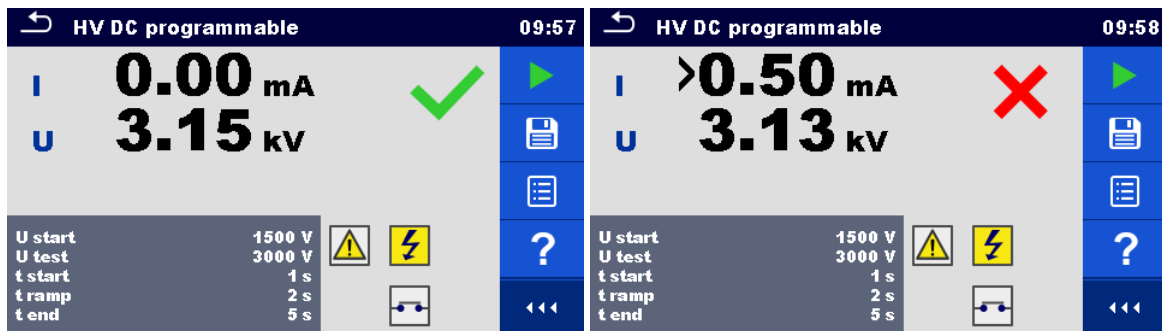

Figure 6.34: Examples of HV DC programmable test results

Note:

- › First HV measurement after power on the instrument (if password protection is enabled) or first HV measurement after enabling or changing password require entering password for enabling HV test. Refer to chapter 4.6.7 *Change password for HV functions* for more information.

6.2.7 Insulation resistance (Riso, Riso-S)

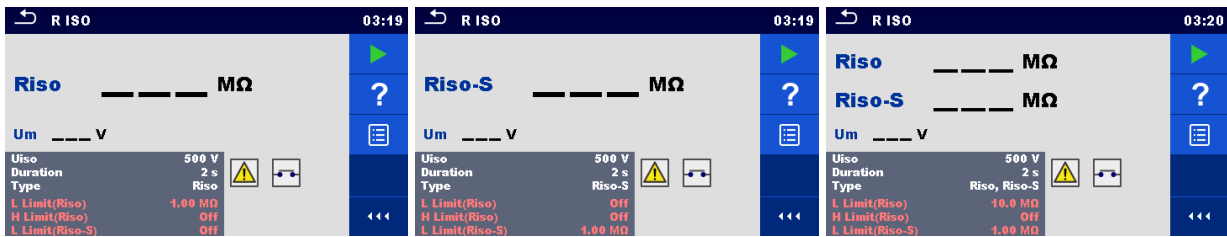

Figure 6.35: Insulation resistance test menus

Test results / sub-results

Riso Insulation resistance
 Riso-S Insulation resistance-S
 Um Test voltage

Test parameters

Nominal test voltage	Uiso [50 V, 100 V, 250 V, 500 V, 1000 V]
Duration	Duration [Off, 2 s ... 180 s]
Type of test	Type [Riso, Riso-S, (Riso, Riso-S)]
Output connections (Riso)	[ISO(+), ISO(-), Socket LN-PE, Socket LN-P/S]
Output connections (Riso-S)	[Socket LN-P/S]

Test limits

H Limit (Riso)	H limit [Off, 0.10 MΩ ... 10.0 MΩ]
L Limit (Riso)	L limit [Off, 0.10 MΩ ... 10.0 MΩ]
H Limit (Riso-S)	H limit [Off, 0.10 MΩ ... 10.0 MΩ]
L Limit (Riso-S)	L limit [Off, 0.10 MΩ ... 10.0 MΩ]

Test circuits

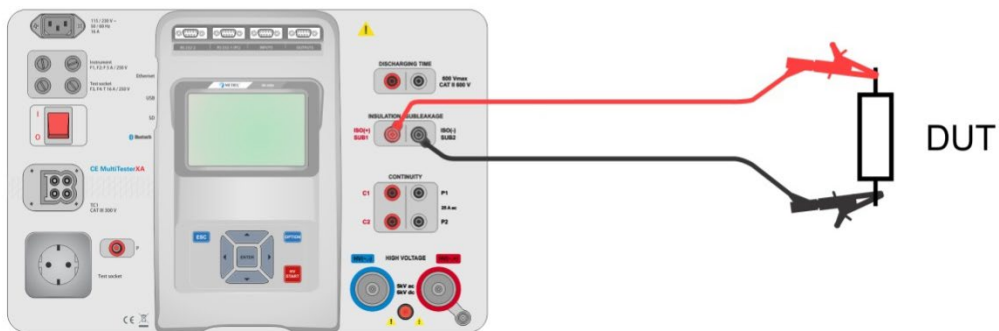

Figure 6.36: Measurement of insulation resistance (ISO(+), ISO(-))

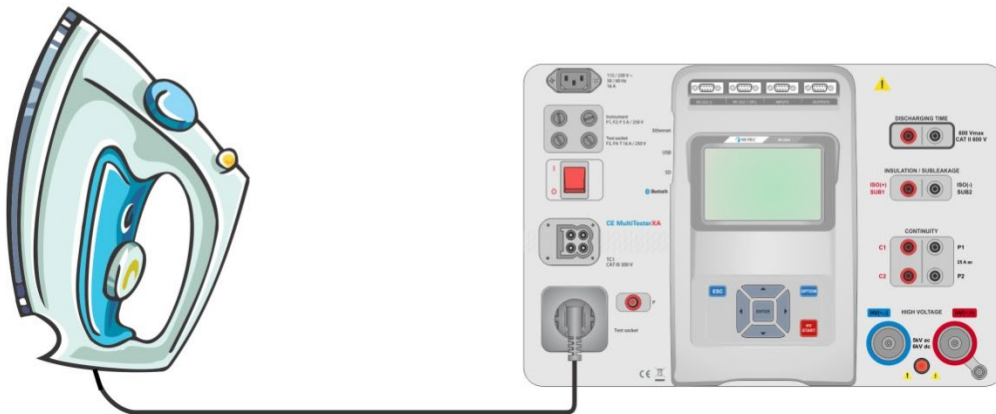

Figure 6.37: Measurement of insulation resistance (Socket LN - PE)

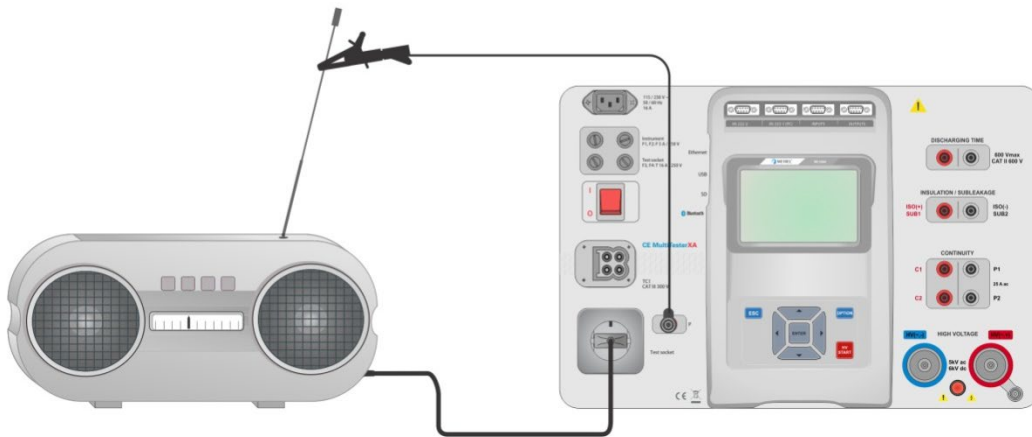

Figure 6.38: Measurement of Riso, Riso-S (socket)

RISO measurement procedure

- › Select the **Riso** function.
- › Set test parameters / limits.
- › Connect test leads to ISO(+), ISO(-) terminals on the instrument, then connect test leads to device under test, or
- › Connect device to mains test socket. For Riso-S test, additionally connect test lead to P/S terminal on instrument, and then connect test lead to device.
- › Start measurement.
- › Measurement can be stopped manually or by timer.
- › Save results (optional).



Figure 6.39: Examples of Insulation resistance measurement results

Note:

- When P/S probe is connected during the Riso measurement, then the current through it is also considered.

6.2.8 Sub-leakage (Isub, Isub-S)

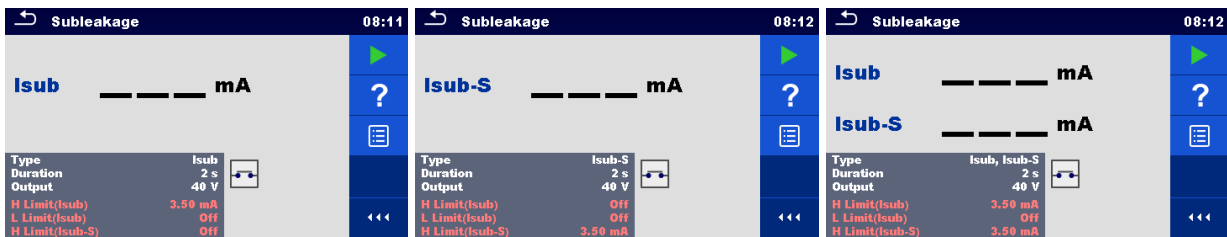

Figure 6.40: Sub Leakage test menus

Test results / sub-results

Isub Sub-leakage current
 Isub-S Sub-leakage current-S

Test parameters

Type of test	Type [Isub, Isub-S, (Isub, Isub-S)]
Output voltage	Output [40 Vac]
Duration	Duration [Off, 2 s ... 180 s]
Output connections (Isub)	[SUB1, SUB2, Socket LN-PE, Socket LN-P/S]
Output connections (Isub-S)	[Socket LN-P/S]

Test limits

H Limit (Isub)	H limit [Off, 0.25 mA ... 15.0 mA, Custom]
L Limit (Isub)	L limit [Off, 0.25 mA ... 15.0 mA, Custom]
H Limit (Isub-S)	H limit [Off, 0.25 mA ... 15.0 mA]
L Limit (Isub-S)	L limit [Off, 0.25 mA ... 15.0 mA]

Test circuits

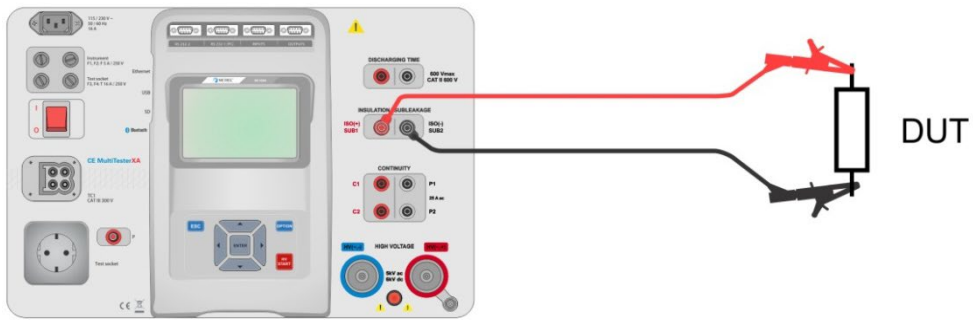

Figure 6.41: Measurement of Sub-leakage (SUB1, SUB2)

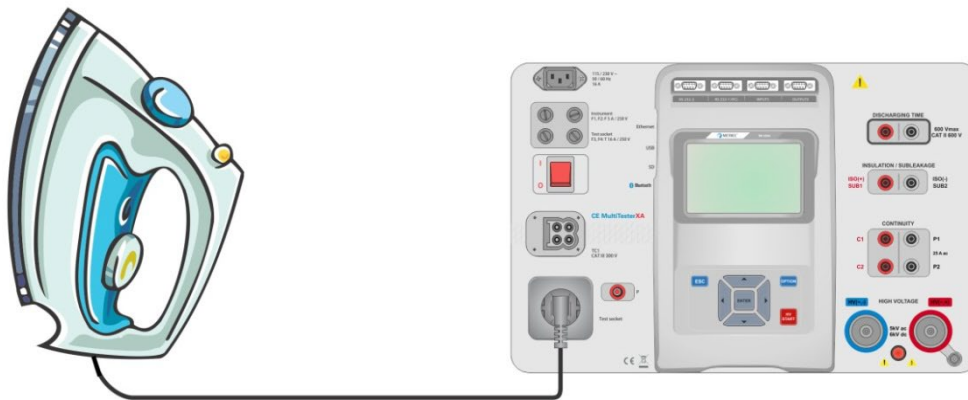

Figure 6.42: Measurement of Sub-leakage (socket LN-PE)

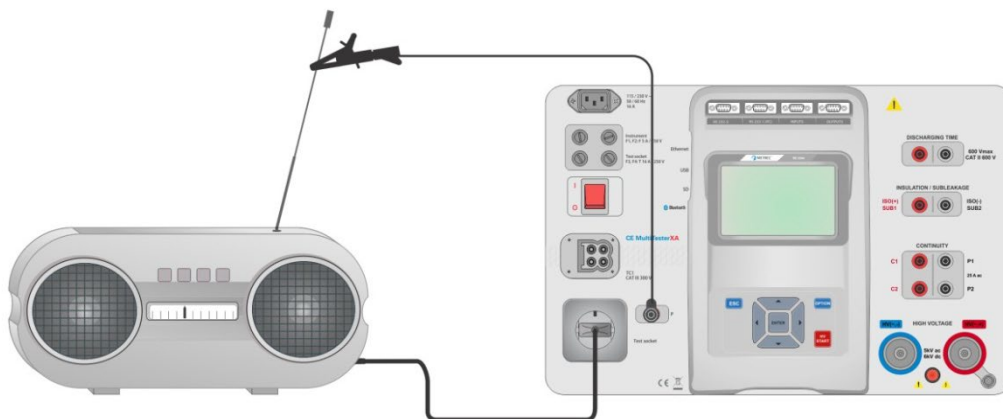

Figure 6.43: Measurement of Sub-leakage, Sub-leakage-S (socket)

Sub-leakage measurement procedure

- › Select the **Sub-leakage** function.
- › Set test parameters / limits.
- › Connect test leads to SUB1, SUB2 terminals on the instrument, then connect test leads to device under test, or
- › Connect device under test to mains test socket. For Isub-S test, additionally connect test lead to P/S terminal on the instrument, and then connect test lead to a device.
- › Start measurement.
- › Measurement can be stopped manually or by timer.

- Save results (optional).

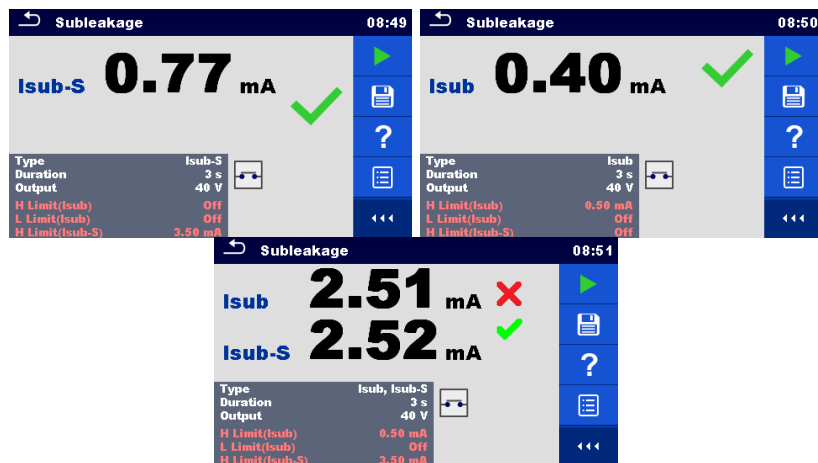

Figure 6.44: Examples of Sub-leakage measurement results

Note:

- When P/S probe is connected during the Sub-leakage measurement, then the current through it is also considered.

6.2.9 Differential Leakage

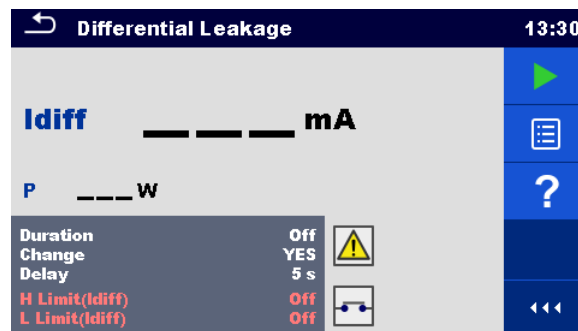

Figure 6.45: Differential Leakage test menu

Test results / sub-results

Idiff Differential Leakage current

P Power

Test parameters

Duration	Duration [Off, 2 s ... 180 s]
Change status	Change [YES, NO] YES: The instrument measures leakage current in two sequential steps with delay* in between. The phase voltage is firstly applied to the right live output of the mains test socket and secondly to the left live output of the mains test socket. NO: The phase voltage is applied only to the right live output of the mains test socket.
*Delay time	Delay [0.2 s ... 5 s]

Test limits

H Limit (Idiff)	H limit [Off, 0.25 mA ... 15.0 mA, Custom]
L Limit (Idiff)	L limit [Off, 0.25 mA ... 15.0 mA, Custom]
Output connections	[Socket L,N – PE,P/S]

Test circuit

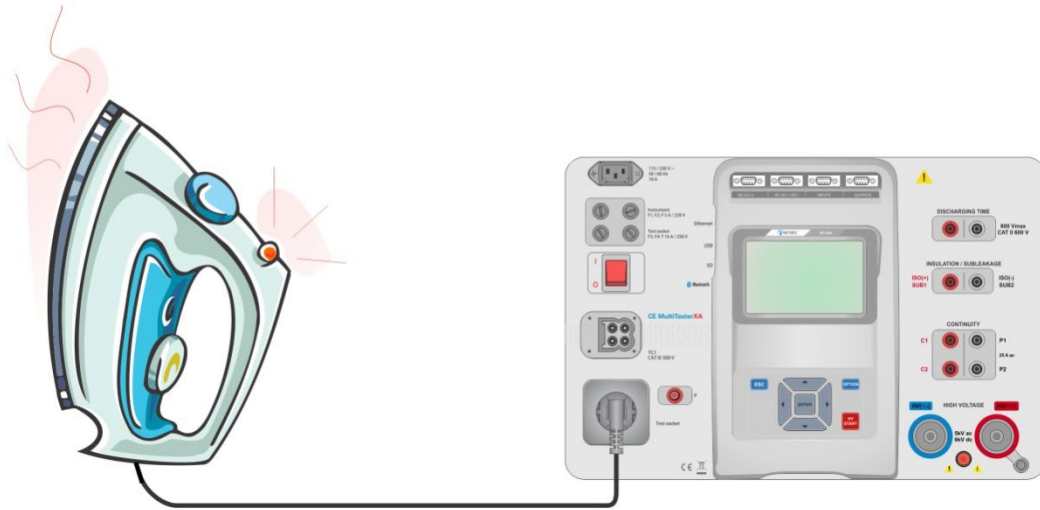

Figure 6.46: Measurement of Differential Leakage current

Differential Leakage measurement procedure

- › Select the **Differential Leakage** function.
- › Set test parameters / limits.
- › Connect device under test to mains test socket and optionally to P/S terminal.
- › Start measurement.
- › Measurement can be stopped manually or by timer.
- › Save results (optional).

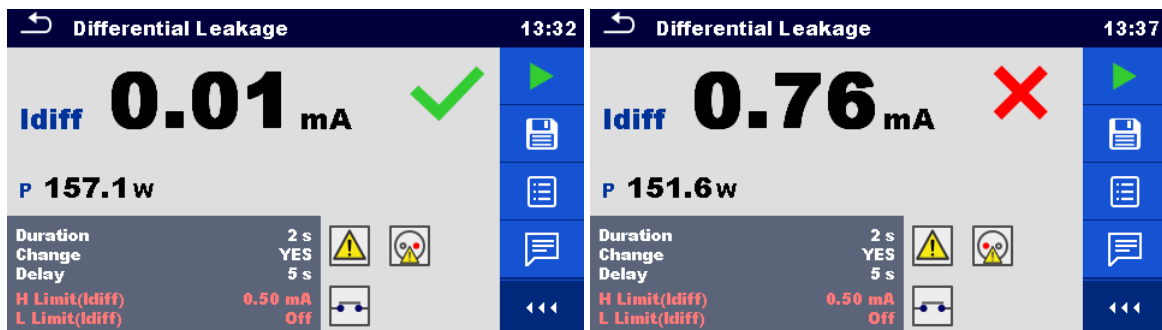

Figure 6.47: Examples of Differential Leakage measurement results

6.2.10 Ipe Leakage

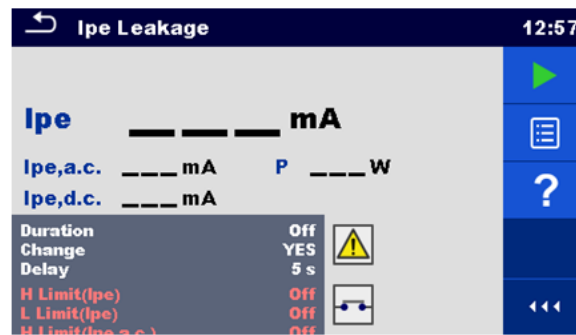

Figure 6.48: Ipe Leakage test menu

Test results / sub-results

Ipe PE current
 Ipe,a.c. a.c. part of PE current
 Ipe,d.c. d.c. part of PE current
 P Power

Test parameters

Duration	Duration [Off, 2 s ... 180 s]
Change status	Change [YES, NO] YES: The instrument measures leakage current in two sequential steps with delay* in between. The phase voltage is firstly applied to the right live output of the mains test socket and secondly to the left live output of the mains test socket. NO: The phase voltage is applied only to the right live output of the mains test socket.
*Delay time	Delay [0.2 s ... 5 s]
Output connections	[Socket L,N – PE]

Test limits

H Limit (Ipe)	H limit [Off, 0.25 mA ... 15.0 mA, Custom]
L Limit (Ipe)	L limit [Off, 0.25 mA ... 15.0 mA, Custom]
H Limit (Ipe,a.c.)	H limit [Off, Custom, 0.25 mA ... 15.0 mA]
L Limit (Ipe,a.c.)	L limit [Off, Custom, 0.25 mA ... 15.0 mA]
H Limit (Ipe,d.c.)	H limit [Off, Custom, 0.25 mA ... 15.0 mA]
L Limit (Ipe,d.c.)	L limit [Off, Custom, 0.25 mA ... 15.0 mA]

Test circuit

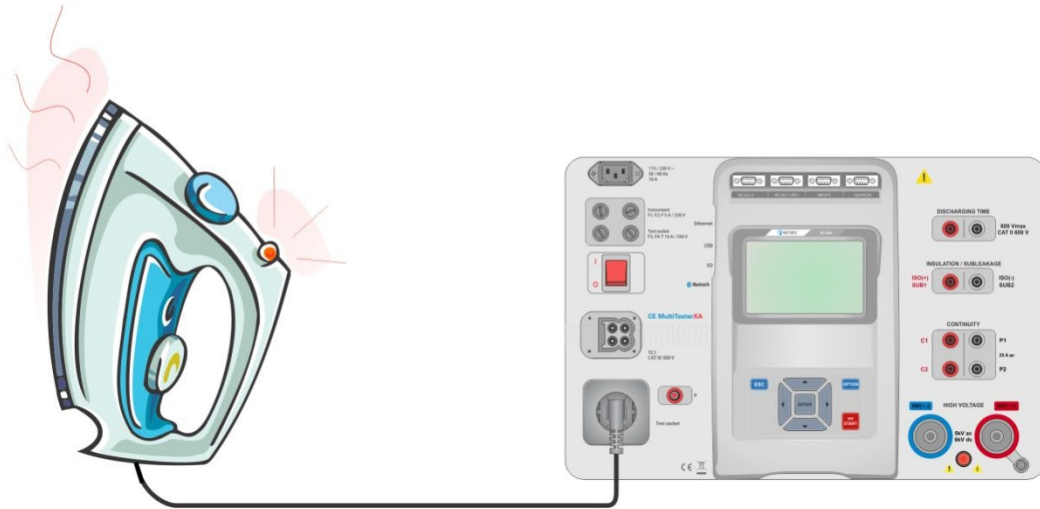

Figure 6.49: Measurement of Ipe Leakage current

Ipe Leakage measurement procedure

- ▶ Select the **Ipe Leakage** function.
- ▶ Set test parameters / limits.
- ▶ Connect device under test to mains test socket.
- ▶ Start measurement.
- ▶ Measurement can be stopped manually or by timer.
- ▶ Save results (optional).



Figure 6.50: Examples of Ipe Leakage measurement results

6.2.11 Touch Leakage

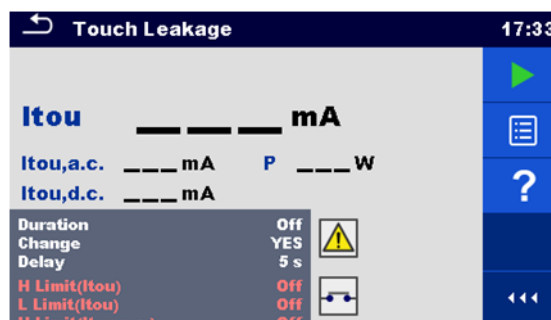

Figure 6.51: Touch Leakage test menu

Test results / sub-results

Itou Touch Leakage current
 Itou,a.c. a.c. part of Touch Leakage current
 Itou,d.c. d.c. part of Touch Leakage current
 P Power

Test parameters

Duration	Duration [Off, 2 s ... 180 s]
Change status	Change [YES, NO] YES: The instrument measures leakage current in two sequential steps with delay* in between. The phase voltage is firstly applied to the right live output of the mains test socket and secondly to the left live output of the mains test socket. NO: The phase voltage is applied only to the right live output of the mains test socket.
*Delay time	Delay [0.2 s ... 5 s]
Output connections	[Socket L,N – PE,P/S]

Test limits

H Limit (Itou)	H limit [Off, 0.25 mA ... 15.0 mA]
L Limit (Itou)	L limit [Off, 0.25 mA ... 15.0 mA]
H Limit (Ipe,a.c.)	H limit [Off, Custom, 0.25 mA ... 15.0 mA]
L Limit (Ipe,a.c.)	L limit [Off, Custom, 0.25 mA ... 15.0 mA]
H Limit (Ipe,d.c.)	H limit [Off, Custom, 0.25 mA ... 15.0 mA]
L Limit (Ipe,d.c.)	L limit [Off, Custom, 0.25 mA ... 15.0 mA]

Test circuit

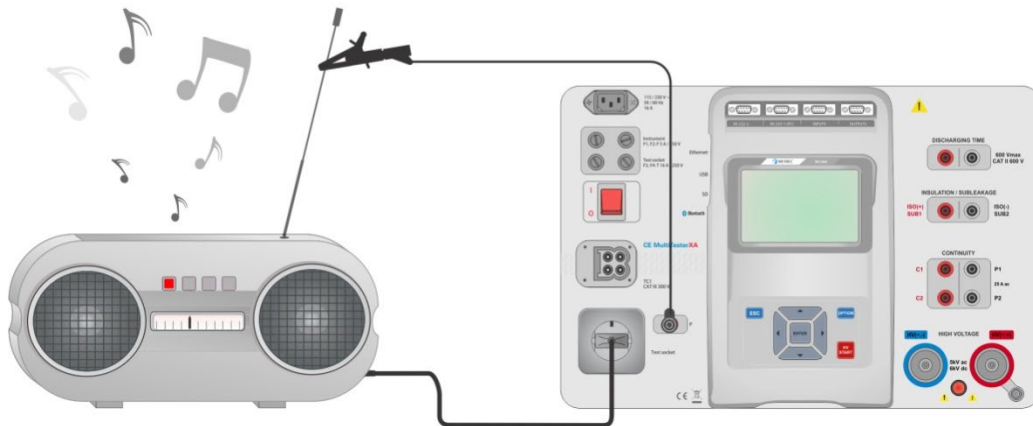

Figure 6.52: Measurement of Touch Leakage current

Touch Leakage measurement procedure

- › Select the **Touch Leakage** function.
- › Set test parameters / limits.
- › Connect device under test to mains test socket. Connect test lead to P/S terminal on the instrument and on device under test.
- › Start measurement.
- › Measurement can be stopped manually or by timer.
- › Save results (optional).



Figure 6.53: Examples of Touch Leakage measurement results

6.2.12 Power

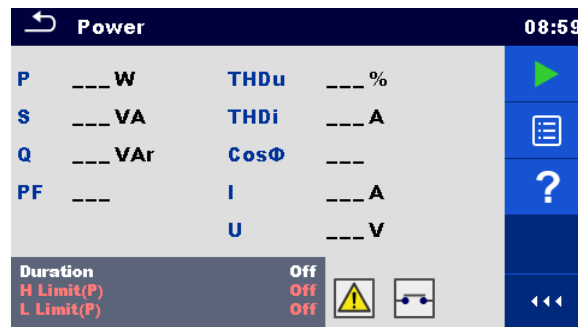

Figure 6.54: Power measurement menu

Test results / sub-results

P Active power
 S Apparent power
 Q Reactive power
 PF Power factor
 THDu Total harmonic distortion – voltage
 THDi Total harmonic distortion – current
 Cos Φ cosinus Φ
 I Load current
 U Voltage

Test parameters

Duration	Duration [Off, 2 s ... 180 s]
Output connections	[Socket L–N]

Test limits

H Limit (P)	H limit [Off, 10 W ... 3.50 kW, Custom]
L Limit (P)	L limit [Off, 10 W ... 3.50 kW, Custom]

Test circuit

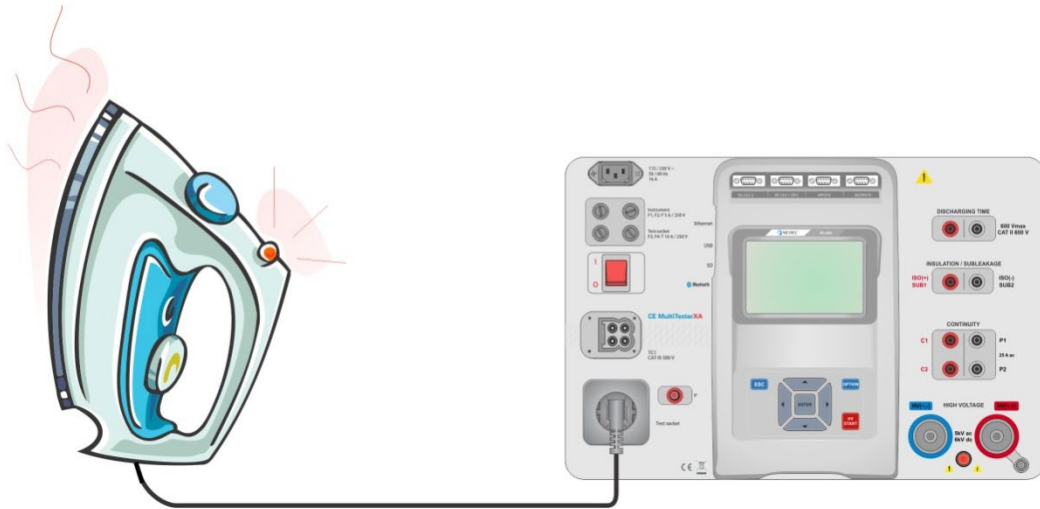

Figure 6.55: Measurement of Power

Power measurement procedure

- › Select the **Power** function.
- › Set test parameters / limits.
- › Connect device under test to mains test socket.
- › Start measurement.
- › Measurement can be stopped manually or by timer.
- › Save results (optional).

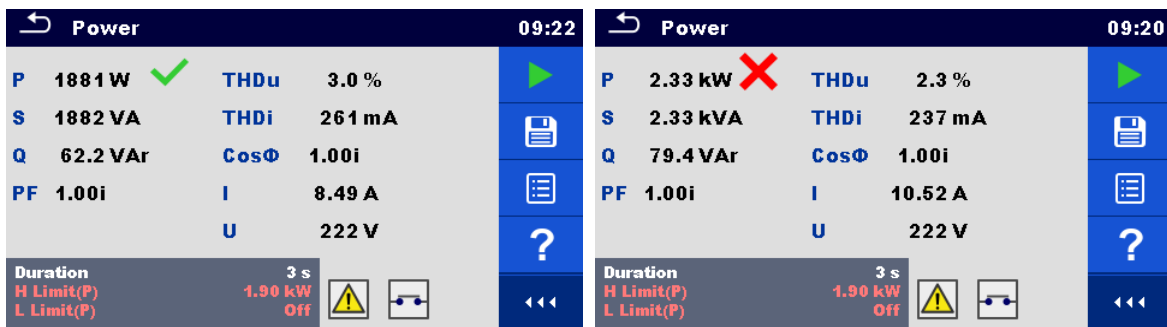

Figure 6.56: Examples of Power measurement results

6.2.13 Leak's & Power

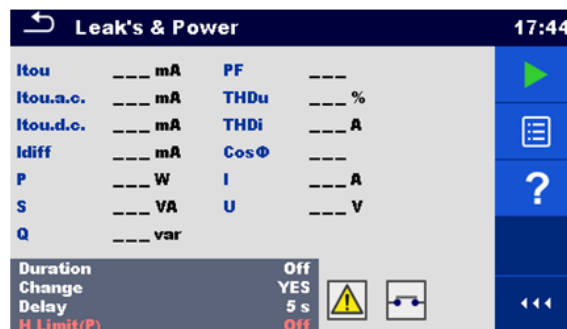

Figure 6.57: Leak's & Power measurement menu

Test results / sub-results

- P Active power
- Itou Touch Leakage current
- Itou,a.c. a.c. part of Touch Leakage current
- Itou,d.c. d.c. part of Touch Leakage current
- Idiff Differential Leakage current
- S Apparent power
- Q Reactive power
- PF Power factor
- THDu Total harmonic distortion – voltage
- THDi Total harmonic distortion – current
- Cos Φ cosinus Φ
- I Load current
- U Voltage

Test parameters

Duration	Duration [Off, 2 s ... 180 s]
Change status	Change [YES, NO] YES: The instrument measures leakage current in two sequential steps with delay* in between. The phase voltage is firstly applied to the right live output of the mains test socket and secondly to the left live output of the mains test socket. NO: The phase voltage is applied only to the right live output of the mains test socket.
*Delay time	Delay [0.2 s ... 5 s]
Output connections	[Socket L–N, Socket L,N – PE,P]

Test limits

H Limit (P)	H limit [Off, 10 W ... 3.50 kW, Custom]
L Limit (P)	L limit [Off, 10 W ... 3.50 kW, Custom]
H Limit (Idiff)	H limit [Off, 0.25 mA ... 15.0 mA, Custom]
L Limit (Idiff)	L limit [Off, 0.25 mA ... 15.0 mA, Custom]
H Limit (Itou)	H limit [Off, 0.25 mA ... 15.0 mA]
L Limit (Itou)	L limit [Off, 0.25 mA ... 15.0 mA]
H Limit (Itou,a.c.)	H limit [Off, Custom, 0.25 mA ... 15.0 mA]
L Limit (Itou,a.c.)	L limit [Off, Custom, 0.25 mA ... 15.0 mA]
H Limit (Itou,d.c.)	H limit [Off, Custom, 0.25 mA ... 15.0 mA]
L Limit (Itou,d.c.)	L limit [Off, Custom, 0.25 mA ... 15.0 mA]

Test circuit

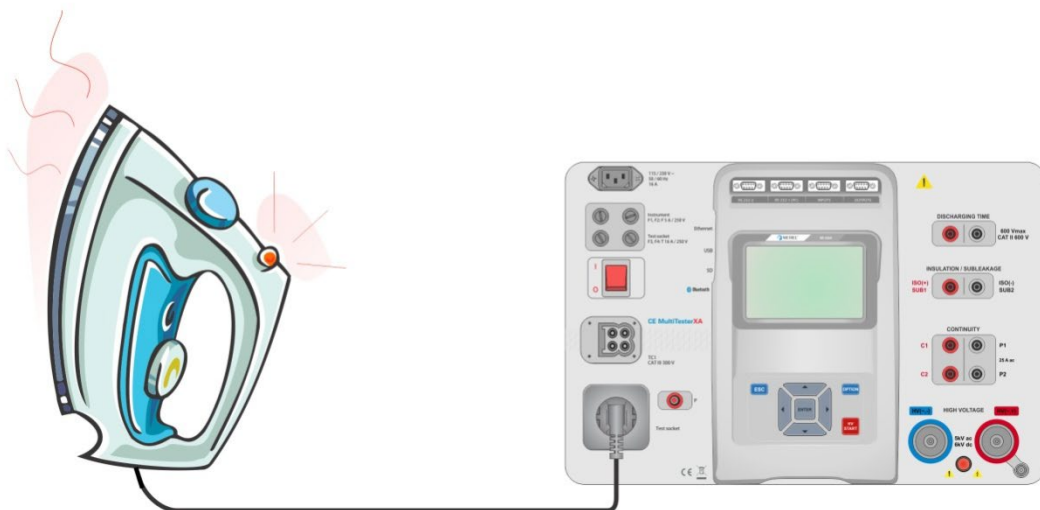

Figure 6.58: Measurement of Leak's and Power

Leak's & Power measurement procedure

- › Select the **Leak's & Power** function.
- › Set test parameters / limits.
- › Connect device under test to mains test socket and optionally to P/S terminal.
- › Start measurement.
- › Measurement can be stopped manually or by timer.
- › Save results (optional).

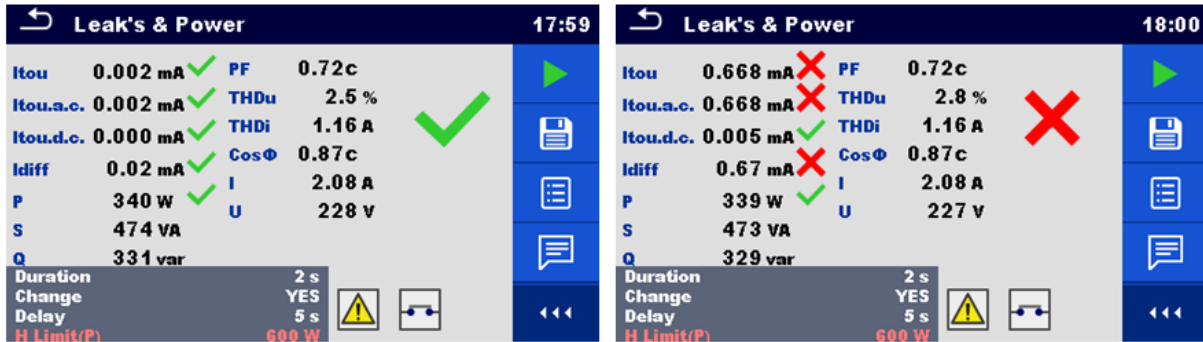

Figure 6.59: Examples of Leak's & Power measurement results

6.2.14 Discharging Time

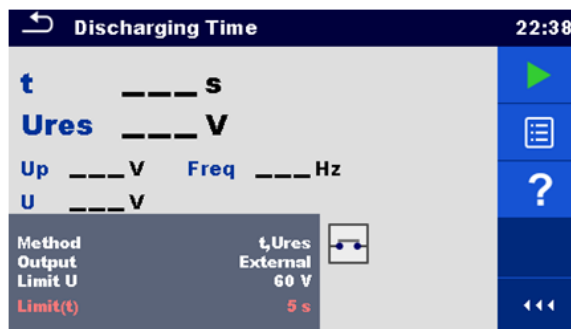

Figure 6.60: Discharging Time test menu

Test results / sub-results

- t Discharging time
- Ures Residual voltage
- Up Peak voltage of supply during the test
- U RMS voltage
- f Frequency

Test parameters

Test method	Method [t, t, Ures]
Limit voltage	Limit U [34 V, 60 V, 120 V]
Output connections	Output [External, Socket]
Test mode	Mode [Manual, Auto]
Delay time for AUTO mode	Delay [2 s ... 30 s]

Test limits

Discharging time limit	Limit(t) [1 s, 5 s]
------------------------	---------------------

Measuring principle (Output = External)

The measuring principle of the Discharging time function is as following:

- Phase ①** The device under test is connected to supply voltage via an external socket. The instrument monitors the voltage (on supply or internal connections) and internally stores the peak voltage value, RMS, voltage and frequency values.
- Phase ②** The device under test is disconnected from the supply and the voltage at the test terminals starts to fall. Once the rms voltage falls for 10 V the instrument starts the timer.
- Phase ③** After the voltage drops below an internally calculated voltage value the timer is stopped. The instrument re-calculates the measured time to a value as it would be if the disconnection occurred at the maximum voltage value.

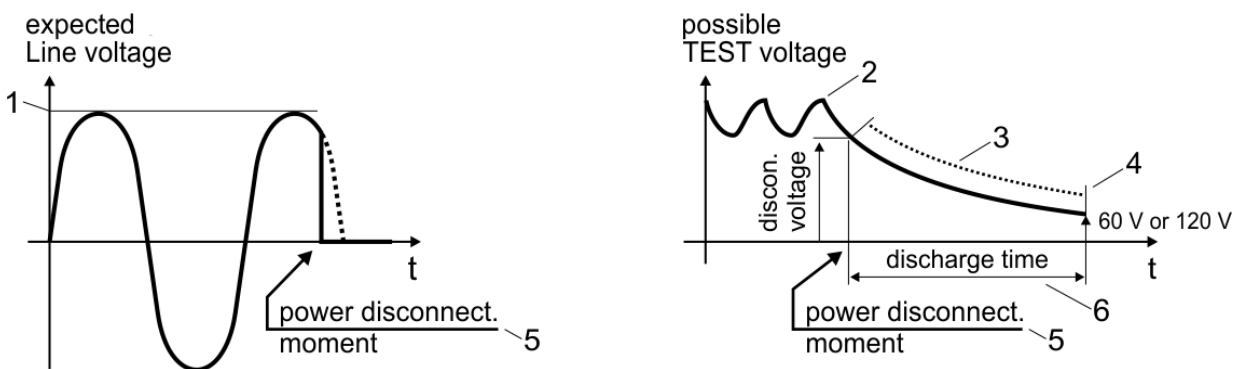

- (1) peak voltage
- (2) voltage at disconnection time
- (3) calculated voltage value
- (4) Ulim
- (5) moment of disconnection
- (6) discharging time

Figure 6.61: Measuring principle (external)

Test circuit (Output = External)

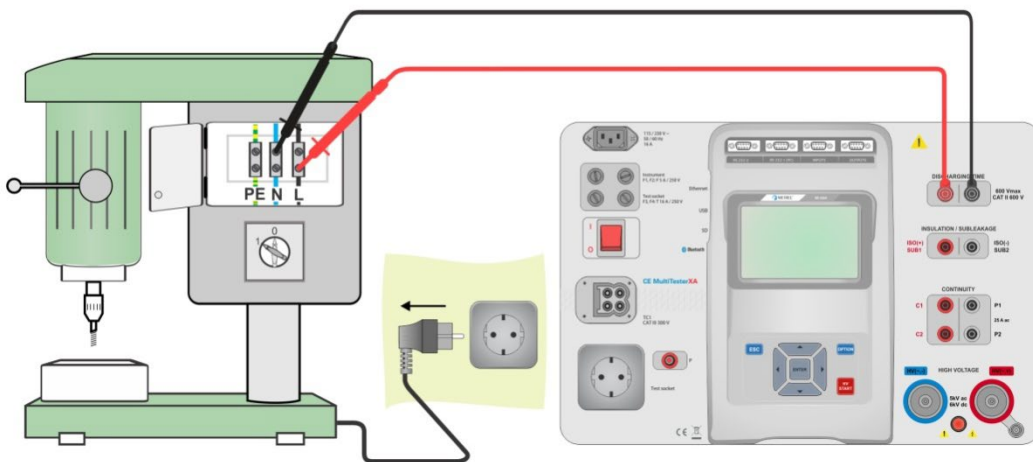

Figure 6.62: Discharging Time test (Output = External)

Discharging Time test procedure (Output = External)

- › Select the **Discharging Time** function.
- › Set test parameters / limits.
- › Connect test leads to the DISCHARGING TIME terminals on the instrument and on the device under test.
- › Connect device under test to the mains supply and Switch it ON.
- › Start measurement.
- › Measurement is stopped manually by disconnecting device under test mains supply.
- › Save results (optional).

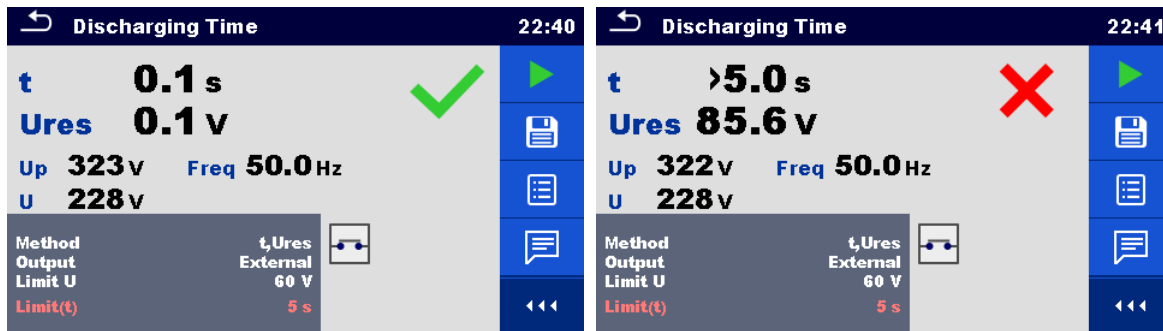

Figure 6.63: Examples of Discharging Time measurement results (Output = External)

Note:

- › Interpretation of the '**Repeat**' message:
It is not possible to differentiate between a disconnection moment at very low voltage and a machine with a very low discharging time. In both cases the reading will be 0.0 s together with the "Repeat" warning. If after few repetitions the result is always 0.0 s with the "Repeat" message it can be considered as a valid 0.0 s result.
A 0.0 s reading without the "Repeat" message is a valid result.

Measuring principle (Output = Socket)

The measuring principle of the Discharging time function is as following:

- Phase ①** The DEVICE UNDER TEST is connected to the mains test socket. The instrument monitors the mains voltage and internally stores the peak voltage value.
- Phase ②** The instrument disconnects the DEVICE UNDER TEST from the supply and the voltage at the supply connections starts to fall. Disconnection moment is always at peak voltage.
- Phase ③** After the voltage drops below the limit value the timer is stopped.

Test circuit (Output = Socket)

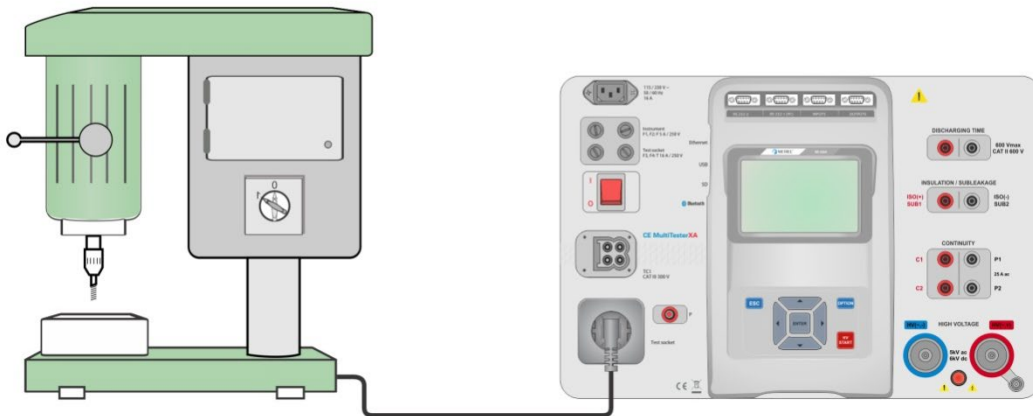

Figure 6.64: Discharging Time test (Output = Socket)

Discharging Time test procedure (Output = Socket)

- ▶ Select the **Discharging Time** function.
- ▶ Set test parameters / limits.
- ▶ Connect the device under test to the mains test socket on the instrument.
- ▶ Start measurement.
- ▶ Measurement can be stopped manually or automatically.
- ▶ Save results (optional).

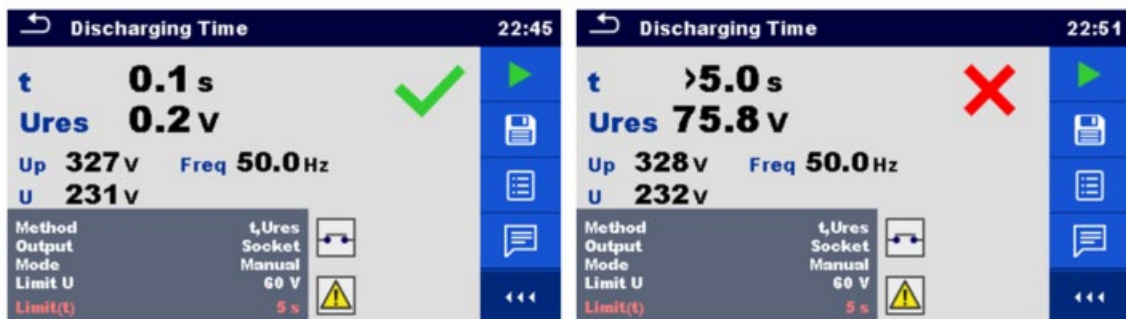

Figure 6.65: Examples of Discharging Time measurement results (Output = Socket)

6.2.15 Functional inspections

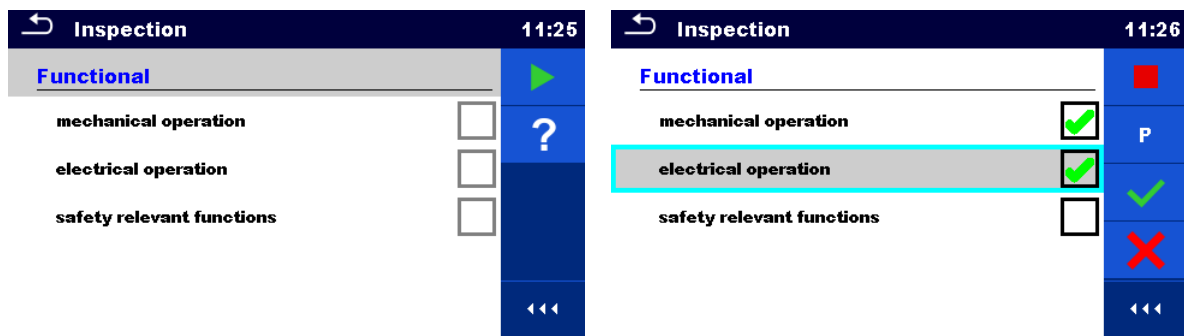

Figure 6.66: Functional inspection start menu (left) and menu during inspection (right)

Test parameters (optional)

For the optional Power measurement test the parameters and limits are the same as set in the Power single test, see chapter 6.2.12 *Power*.

Test circuit

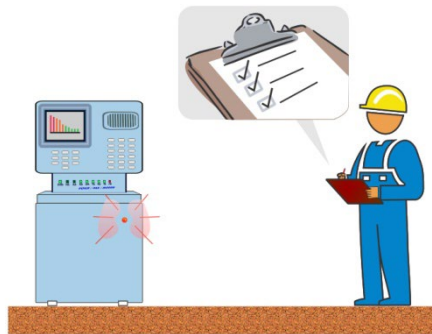

Figure 6.67: Functional inspection

Functional inspection procedure

- › Select the appropriate **Functional** inspection.
- › Start the inspection.
- › Perform the functional inspection of the appliance / equipment.
- › Perform the Power measurement test through the mains test socket (optional).
- › Apply appropriate ticker(s) to items of inspection.
- › End the inspection.
- › Save results (optional).

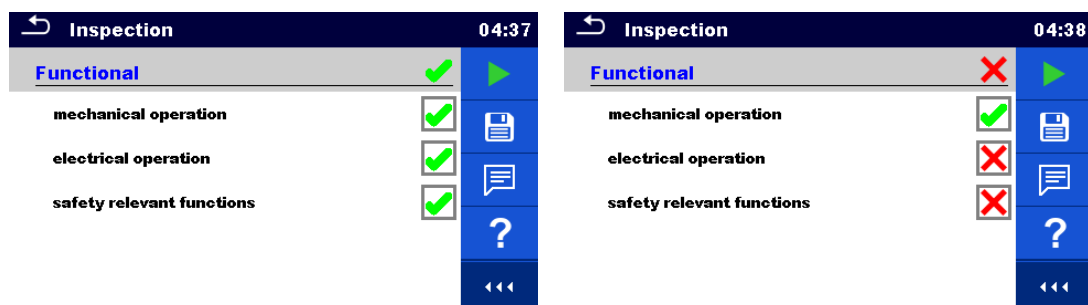

Figure 6.68: Examples of Functional Inspection results

7 Auto Sequences®

Preprogrammed sequences of measurements can be carried out in Auto Sequences® menu. The sequence of measurements, their parameters and flow of the sequence can be programmed. The results of an Auto Sequence® can be stored in the memory together with all related information.

Auto Sequences® can be pre-programmed on PC with the MTLINK software and uploaded to the instrument. On the instrument parameters and limits of individual single test in the Auto Sequence® can be changed / set.

7.1 Selection of Auto Sequences®

Required Auto Sequence® group from Auto Sequence® groups menu should be selected first. Refer to Chapter 4.9 *Auto Sequence® groups* for more details.



Auto Sequence® to be carried out can then be selected from the Main Auto Sequences® menu, which can be organized in structural manner with folders and sub-folders containing Auto Sequences®.

Searching by name or short code is also possible within the active Auto Sequence® group. Refer to Chapter 7.1.2 *Searching in Auto Sequences® menu* for details.

7.1.1 Selecting an active Auto Sequence® group in Auto Sequences® menu

Auto Sequences® and Auto Sequence® group menus are interconnected so an active Auto Sequence® group can be also selected in the Auto Sequences® menu.

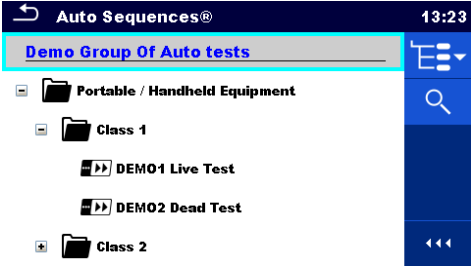
Procedure

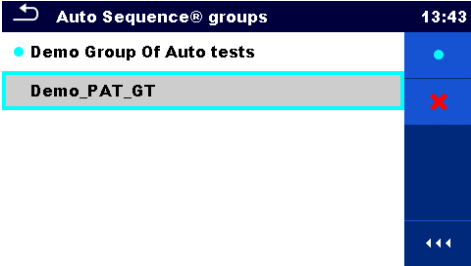
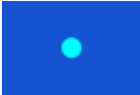
①		Select Auto Sequence® group header in Auto Sequences® menu by tapping on it.
②		Selects the Auto Seq. groups icon from Control panel. Auto Sequence® groups menu appear on the screen.
③		Selects desired Auto Sequence® group from available groups.
④		Confirms a new selection.

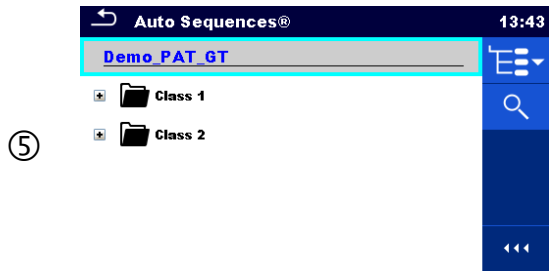

New Auto Sequence® group is selected and all folders, sub-folders and Auto Sequences® within that group are displayed on the screen.

7.1.2 Searching in Auto Sequences® menu

In Auto Sequence® menu it is possible to search for Auto Sequences® on base of their Name or Short code.

Procedure

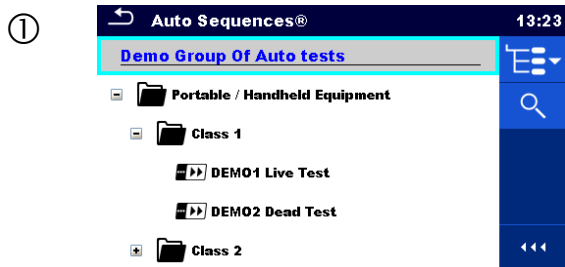

Select Auto Sequence® group header in Auto Sequences® menu by taping on it.



Select Search from options menu to open Search setup menu.

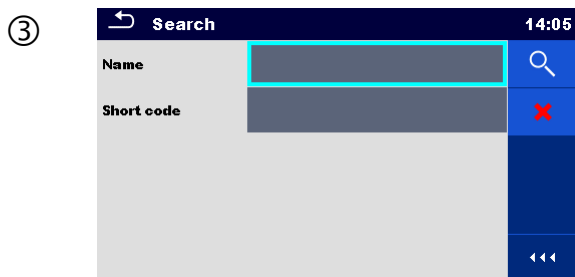

The parameters that can be searched for are displayed in the Search setup menu.



The search can be narrowed by entering a text in the Name and Short code fields.

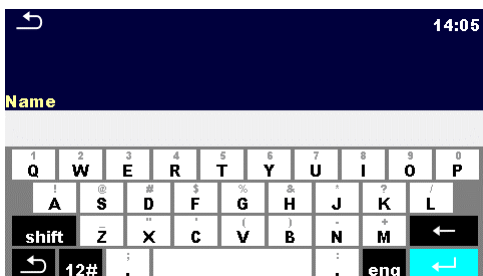

Strings can be entered by using the on-screen keyboard.



Clears all filters. Sets filters to default value.

④



Searches through the active Auto Sequence® group according to the set filters. The results are shown in the Search results screen presented on *Figure 7.1* and *Figure 7.2*.

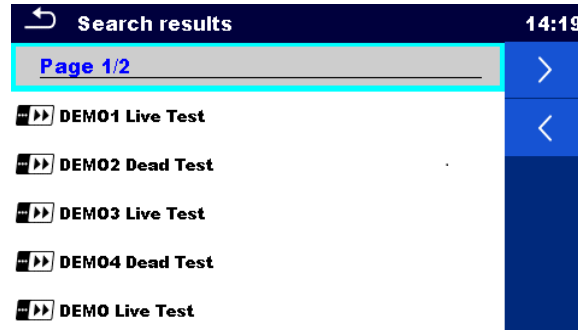

Figure 7.1: Search results screen Page view

Options



Next page.



Previous page.

Note:

- Search result page consist of up to 50 results.

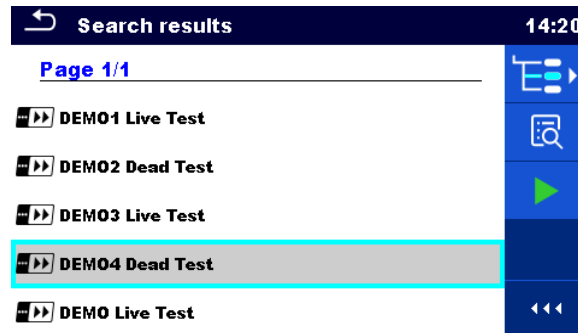

Figure 7.2: Search results screen with Auto Sequence® selected

Options



Goes to location in Auto Sequences® menu.



Goes to Auto Sequence® view menu.



Starts the selected Auto Sequence®.

7.1.3 Structure organization of Auto Sequence® group

The Auto Sequences® to be carried out can be selected from the active group in Main Auto Sequences® menu. This menu can be organized in a structural manner with folders, sub-folders and Auto Sequences®. Auto Sequence® in the structure can be the original Auto Sequence® or a shortcut to the original Auto Sequence®. Auto Sequences® marked as shortcuts and the original auto Sequences® are coupled. Changing of parameters or limits in any of the coupled Auto Sequences® will influence on the original Auto Sequence® and all its shortcuts.

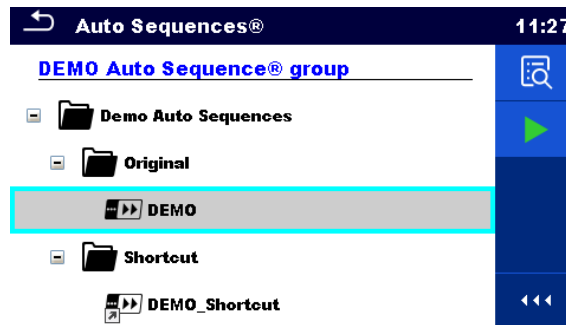

Figure 7.3: Structure organization of Auto Sequence® group, Auto Sequence® selected

Options

	The original Auto Sequence®.
	A shortcut to the original Auto Sequence®.
	Enters menu for more detail view of selected Auto Sequence®. This option should also be used if the parameters / limits of the selected Auto Sequence® have to be changed. Refer to chapter 7.2.1 <i>Auto Sequence® view</i> menu for more information.
	Starts the selected Auto Sequence®. The instrument immediately starts the Auto Sequence®.
	Enters Auto Sequence® Configurator menu (if available). See chapter 7.2.1.3 <i>Auto Sequence® Configurator menu</i> for details.

7.2 Organization of Auto Sequence® tests

An Auto Sequence® test is divided into three phases:

- › Before starting the first test the Auto Sequence® view menu is shown (unless it was started directly from the Main Auto Sequence® menu). Parameters and limits of individual measurements can be set in this menu.
- › During the execution phase of an Auto Sequence®, pre-programmed single tests are carried out. The sequence of single tests is controlled by pre-programmed flow commands.
- › After the test sequence is finished the Auto Sequence® result menu is shown. Details of individual tests can be viewed and the results can be saved to Memory organizer.

7.2.1 Auto Sequence® view menu

In the Auto Sequence® view menu the header and the single tests of selected Auto Sequence® are displayed. The header contains Name, Short code (if set) and description of the Auto Sequence®. Before starting the Auto Sequence®, test parameters / limits of individual measurements can be changed.

7.2.1.1 Auto Sequence® view menu (header is selected)

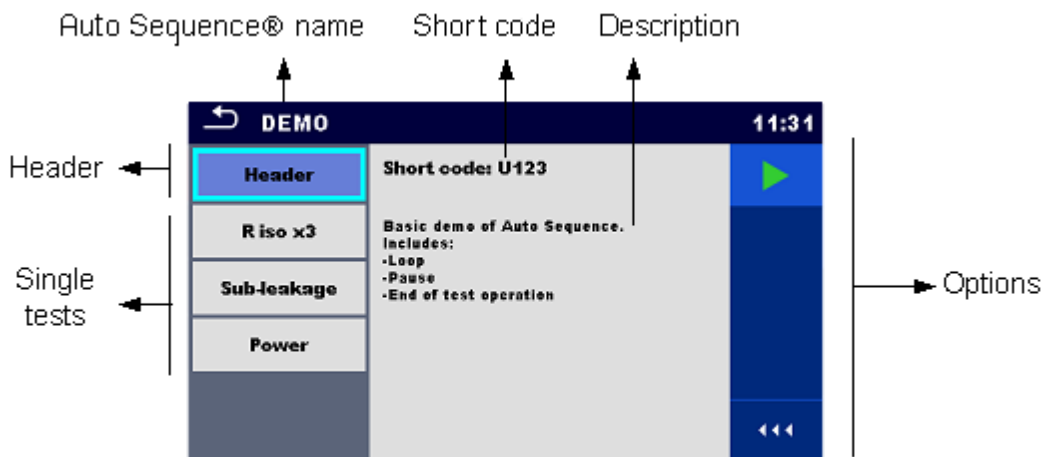

Figure 7.4: Auto Sequence® view menu – header selected

Options



Starts the Auto Sequence®.



Enters Auto Sequence® Configurator menu (if available).

See chapter 7.2.1.3 *Auto Sequence® Configurator menu* for details.

7.2.1.2 Auto Sequence® view menu (measurement is selected)

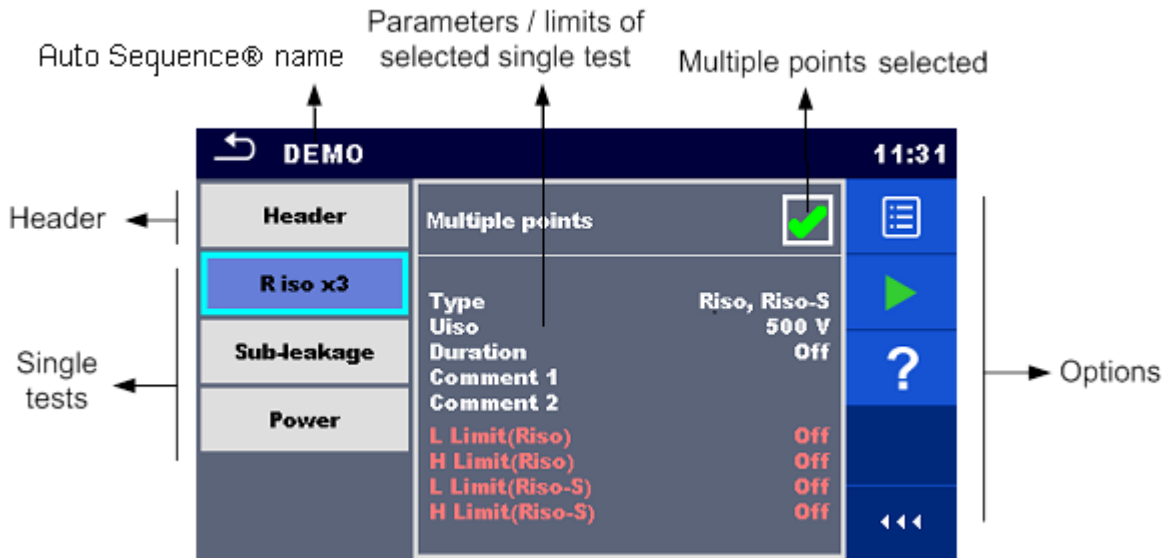

Figure 7.5: Auto Sequence® view menu – measurement selected

Options



Selects single test.



Opens menu for changing parameters and limits of selected measurements.

Refer to chapter 6.1.1.2 *Setting parameters and limits of single tests* for more information how to change measurement parameters and limits.

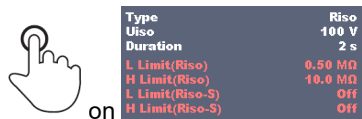

Starts the selected Auto Sequence®.



Compensates test leads resistance in selected test function (if applicable). Refer to chapter 6.2.2.1 *Compensation of test leads resistance* for more information.



Opens the Help menu of selected test.



Selects Multiple points.

Multiple points



Sets operation mode for multiple points. For more information see chapter 7.2.1.4 *Managing multiple points*.

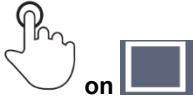

Multiple points



7.2.1.3 Auto Sequence® Configurator menu

Auto Sequence® Configurator menu options are active only when single tests within selected Auto sequence® contain configurable limits and / or parameters. They can be changed to suit requirements of current object under test before Auto sequence® execution. Original settings are overwritten for intended Auto sequence® execution only.

Select  Configurator option from Auto sequence® Main screen or View screen to open Configurator menu presented on *Figure 7.6* below.

Available settings are organized in groups, each group starts with concerned Single test name. Limit Calculator is referred to Continuity function. Refer to Single test description chapter for details of parameters and limits setting / calculation.

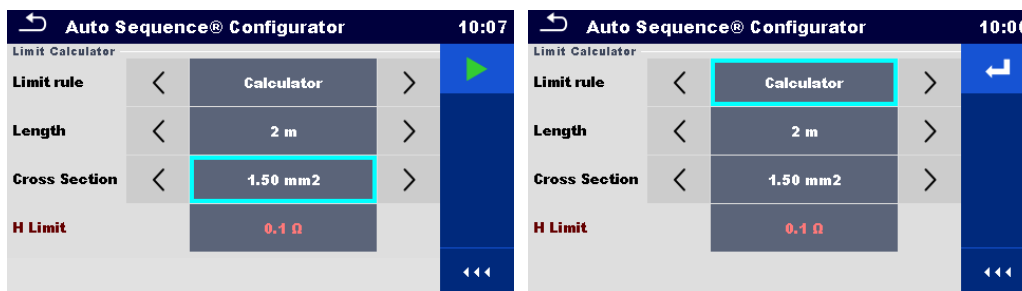

Figure 7.6: Auto Sequence® Configurator menu – opened from Auto Sequence® Main menu on the left, on the right opened from Auto Sequence® view menu

Options



Starts the Auto Sequence® from Configurator menu. Option is available, if configurator was opened from Auto Sequence® Main menu. New configuration is automatically applied to all related single tests.



Confirms limits and parameters setting and returns to view menu. Option is available, if configurator was opened from Auto Sequence® view menu. Start the Auto Sequence® from view menu with confirmed configuration.

7.2.1.4 Indication of Loops

R iso x3

The attached 'x3' at the end of single test name indicates that a loop of single tests is programmed. This means that the marked single test will be carried out as many times as the number behind the 'x' indicates. It is possible to exit the loop before, at the end of each individual measurement.

7.2.1.5 Managing multiple points

If the device under test has more than one test point for an individual single test and the selected Auto Sequence® predicts only one test point (one single test) it is possible to change the Auto Sequence® appropriately. Single tests with enabled Multiple points ticker will be executed in a continuous loop. It is possible to exit the loop anytime at the end of each individual measurement.

The Multiple points setting is valid only for the actual Auto Sequence®. If the user often tests appliances with more than one test points it is recommended to program a special Auto Sequence® with pre-programmed loops.

7.2.2 Step by step execution of Auto Sequences®

While the Auto Sequence® is running it is controlled by pre-programmed flow commands. Examples of actions controlled by flow commands are:

- pauses during the test sequence
- monitoring of input pins
- control of lamps, test adapters and other external devices
- proceeding of test sequence in regard to measured results
- etc.

The actual list of flow commands is available on chapter **E.5 Description of flow commands**.

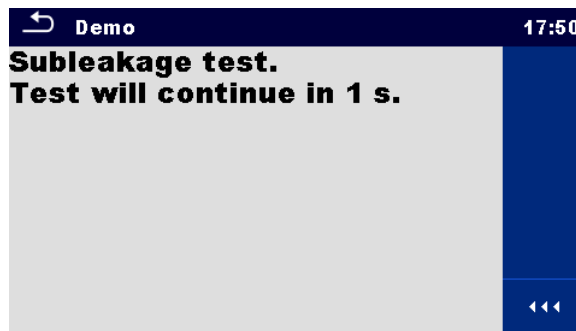

Figure 7.7: Auto Sequence® – example of a pause with message

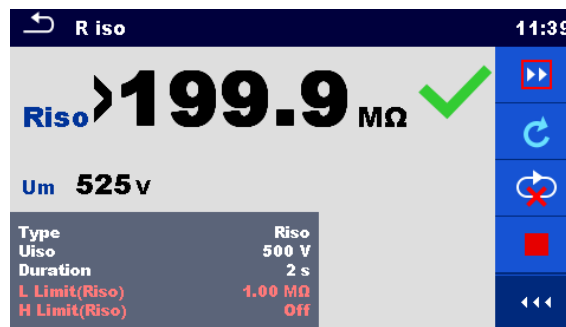

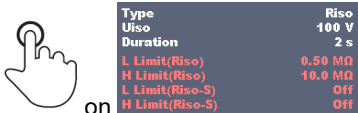



Figure 7.8: Auto Sequence® – example of a finished measurement with options for proceeding

Options (during execution of an Auto Sequence®)

	Proceeds to next step in the test sequence. Repeats the measurement if multiple points execution is selected. Displayed result of a single test will be stored.
	Repeats the measurement. Displayed result of a single test will not be stored.
	Ends the Auto test and goes to Auto test result screen. Refer to chapter 7.2.3 <i>Auto Sequence® result screen</i> for more information.

	Exits the loop of single tests (pre-programmed loop or multiple points execution) and proceeds to the next step in the test sequence.														
	Opens menu for viewing parameters and limits of a current measurement.														
	<table border="1"> <tr> <td>Type</td> <td>Riso</td> </tr> <tr> <td>Uiso</td> <td>100 V</td> </tr> <tr> <td>Duration</td> <td>2 s</td> </tr> <tr> <td>L Limit(Riso)</td> <td>0.50 MΩ</td> </tr> <tr> <td>H Limit(Riso)</td> <td>10.0 MΩ</td> </tr> <tr> <td>L Limit(Riso-S)</td> <td>off</td> </tr> <tr> <td>H Limit(Riso-S)</td> <td>off</td> </tr> </table>	Type	Riso	Uiso	100 V	Duration	2 s	L Limit(Riso)	0.50 MΩ	H Limit(Riso)	10.0 MΩ	L Limit(Riso-S)	off	H Limit(Riso-S)	off
Type	Riso														
Uiso	100 V														
Duration	2 s														
L Limit(Riso)	0.50 MΩ														
H Limit(Riso)	10.0 MΩ														
L Limit(Riso-S)	off														
H Limit(Riso-S)	off														
	<p>Adds comment.</p> <p>The instrument opens keypad for entering a comment to a current measurement.</p>														

The offered options in the control panel depend on the selected single test, its result and the programmed test flow.

Note:

- During Auto Sequence® the popup Warning messages (see chapter 4.4 Symbols and messages) are displayed only before the single test inside one Auto Sequence®. This default setting can be changed with appropriate flow command. For more information about programming Auto Sequences® refer to chapter Appendix E - Programming of Auto Sequences® on MT Link.

7.2.3 Auto Sequence® result screen

After the Auto Sequence® is finished the Auto Sequence® result screen is displayed as presented on Figure 7.8. At the left side of the display the single tests and their statuses are shown. In the middle of the display the header of the Auto Sequence® is displayed and at the top the overall Auto Sequence® status is displayed. Refer to chapter 5.1.1 Measurement statuses for more information.

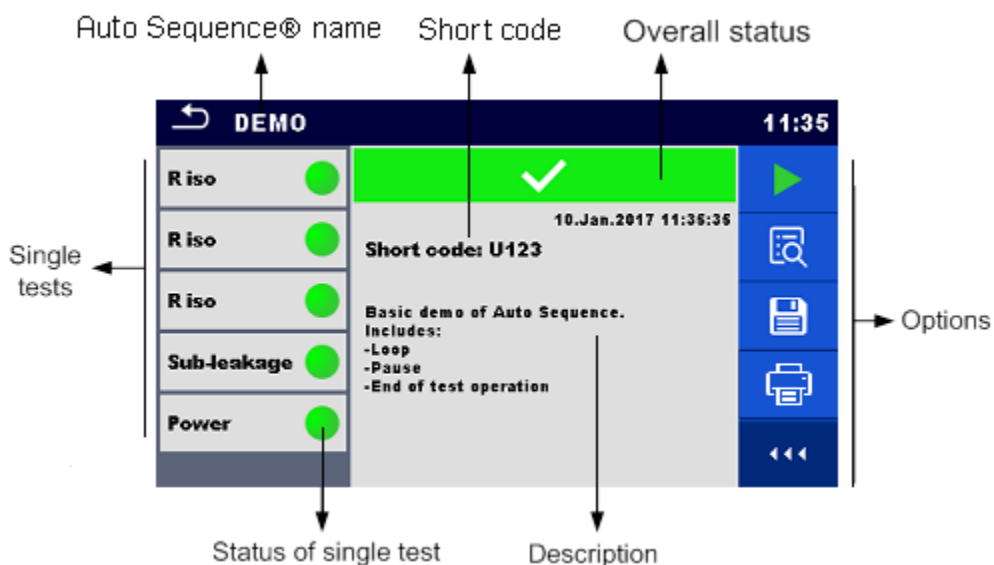











Figure 7.9: Auto Sequence® result screen



Options

	<p>Start Test Starts a new Auto Sequence®.</p>
	<p>View results of individual measurements. The instrument goes to menu for viewing details of the Auto Sequence®, see <i>Figure 7.9</i>.</p>
	<p>Adds comment to the Auto Sequence®. The instrument opens keypad for entering a comment.</p>
	<p>Saves the Auto Sequence® results. A new Auto Sequence® was selected and started from a Structure object in the structure tree:<ul style="list-style-type: none">› The Auto Sequence® will be saved under the selected Structure object.A new Auto Sequence® was started from the Auto Sequence® main menu:<ul style="list-style-type: none">› Saving under the last selected Structure object will be offered by default. The user can select another Structure object or create a new Structure object. By pressing  in Memory organizer menu the Auto Sequence® is saved under selected location.An empty measurement was selected in structure tree and started:<ul style="list-style-type: none">› The result(s) will be added to the Auto Sequence®. The Auto Sequence® will change its overall status from 'empty' to 'finished'.An already carried out Auto Sequence® was selected in structure tree, viewed and then restarted:<ul style="list-style-type: none">› A new Auto Sequence® will be saved under the selected Structure object.</p>
	<p>Print label. See chapter 4.6.9 <i>Devices</i> for details how to enable and set the printer. For more information refer to chapter <i>Appendix C - Print labels and write / read RFID / NFC tags</i>.</p>
	<p>Print and Save Auto Sequence® results simultaneously. Option is available if Devices parameter Auto save is set to On print, se chapter 4.6.9 <i>Devices</i> for more information.</p>
	<p>Write RFID/NFC tag. Refer to <i>Appendix C - Print labels and write / read RFID / NFC tags</i> for supported tag types.</p>
	<p>Write RFID / NFC tag and Save Auto Sequence® results simultaneously. Option is available if Devices parameter Auto save is set to On write, see chapter 4.6.9 <i>Devices</i> for more information.</p>

Note:

Options menu content depends on Devices settings menu. If no writing device is set, than 'Print label' and 'Write RFID' icons are hidden. Only one writing device can be set at the same time.

Options (menu for viewing details of Auto Sequence® results):

	<p>Details of selected single test in Auto Sequence® are displayed, see <i>Figure 7.9</i>.</p>
	<p>Adds comment to the selected single test in Auto Sequence®. The instrument opens keypad for entering a comment.</p>



View parameters and limits of selected single test.



Figure 7.10: Details in Auto Sequence® results menu screens

7.2.4 Auto Sequence® memory screen

In Auto Sequence® memory screen details of the auto test can be viewed, labels can be printed and a new Auto Sequence® can be restarted.

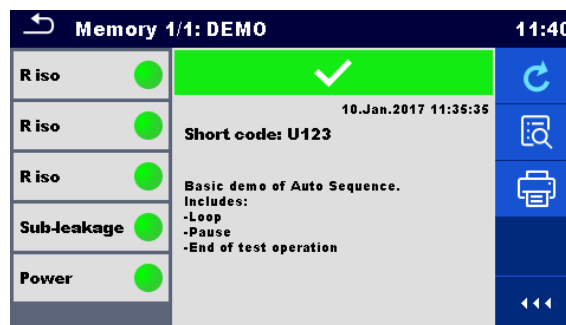

Figure 7.11: Auto Sequence® memory screen

Options



Retest the Auto Sequence®.
Enters menu for a new Auto Sequence®.



Enters menu for viewing details of the Auto Sequence®. Refer to chapter 7.2.3 *Auto Sequence® result* screen for more information.



Print label.
See chapter 4.6.9 *Devices* for details how to enable and set the printer. For more information refer to chapter *Appendix C - Print labels and write / read RFID / NFC tags*.



Write RFID/NFC tag. All data including Auto Sequence® results are written to the RFID/NFC writing device. Refer to chapter *Appendix C - Print labels and write / read RFID / NFC tags* for supported tag types.

Note:

Options menu content depends on Devices settings menu. If no writing device is set, than 'Print label' and 'Write RFID' icons are hidden. Only one writing device can be set at the same time.

8 Communications

8.1 USB and RS232 communication with PC

The instrument automatically selects the communication mode according to detected interface. USB interface has priority.

How to establish an USB or RS-232 link:

-
- › RS-232 communication: connect a PC COM port to the instrument RS232-2 connector using the RS232 serial communication cable;
 - › USB communication: connect a PC USB port to the instrument USB connector using the USB interface cable.
 - › Switch on the PC and the instrument.
 - › Run the *MTLink software*.
 - › Select communication port.
 - › The PC and the instrument will automatically recognize each other.
 - › The instrument is prepared to communicate with the PC.
-

MTLink is a PC software running on Windows 10 and Windows 11.

8.2 Bluetooth communication

The internal Bluetooth module enables easy communication via Bluetooth with PC and Android devices. This function is not operational with the CA 6165 and MTLink PC software. It is reserved for other versions of this equipment.

How to configure a Bluetooth link between instrument and PC

-
- › Switch On the instrument.
 - › On PC configure a Standard Serial Port to enable communication over Bluetooth link between instrument and PC. Usually no code for pairing the devices is needed.
 - › Run the *MTLink software*.
 - › Select configured communication port.
 - › The PC and the instrument will automatically recognize each other.
 - › The instrument is prepared to communicate with the PC.
-

How to configure a Bluetooth link between instrument and Android device

-
- › Switch On the instrument.
 - › Some Android applications automatically carry out the setup of a Bluetooth connection. It is preferred to use this option if it exists. This option is supported by Chauvin Arnoux's Android applications.
 - › If this option is not supported by the selected Android application then configure a Bluetooth link via Android device's Bluetooth configuration tool. Usually no code for pairing the devices is needed.
 - › The instrument and Android device are ready to communicate.
-

Notes

- › Sometimes there will be a demand from the PC or Android device to enter the code. Enter code 'NNNN' to correctly configure the Bluetooth link.
- › The name of correctly configured Bluetooth device must consist of the instrument type plus serial number, eg. *CA 6165-122404291*. If the Bluetooth module got another name, the configuration must be repeated.
- › In case of serious troubles with the Bluetooth communication it is possible to reinitialize the internal Bluetooth module. The initialization is carried out during the Initial settings procedure. In case of a successful initialization "INITIALIZING... OK!" is displayed at the end of the procedure. See chapter 4.6.10 *Initial Settings*.
- › Check if there are available Chauvin Arnoux Android applications for this instrument.

8.3 Bluetooth communication with printers and scanners

The C.A 6165 instrument can communicate with supported Bluetooth printers and scanners. Contact Chauvin Arnoux or your distributor which external devices and functionalities are supported. See Chapter 4.6.9 *Devices* for details how to set the external Bluetooth devices.

8.4 Ethernet communication

The instrument is also capable of communicating through an Ethernet port. The Ethernet communication must be fully configured in the setting menu before first use. See chapter 4.6.8 *Settings* for details. Please note that this communication port does not work with the MTLINK software, it is reserved for future developments of the product.

8.5 RS232 communication with other external devices

It is possible to communicate with scanners via the RS232-2 serial port and printers via the RS232-1 serial port. Contact Chauvin Arnoux or your distributor which external devices and functionalities are supported.

8.6 Connections to test adapters

8.6.1 Test connector TC1

The 8 pin test connector TC1 is intended for connection of external test adapters. TC1 consists of Measuring signal connector and Communication signal connector.

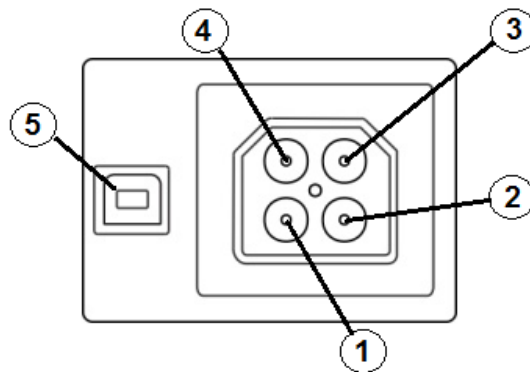

Figure 9.1: Test connector TC1 layout

Legend:

4 pin measuring signal connection (Safety connector)

1	In parallel to terminal N on mains test socket
2	In parallel to terminal L on mains test socket
3	In parallel to terminal PE on mains test socket
4	In parallel to terminal P/S

4 pin communication signal connection¹⁾ (USB type connector)

5	Rx, Tx, +5V, GND
---	------------------

Note

- ¹⁾Do not connect USB communication cable to 4 pin communication signal connector. It is intended only for connection to test adapters.

8.7 INPUTs

The DB9 connector INPUTs is intended for connection of external control signals.

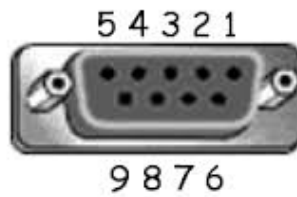

Figure 9.2: INPUT connector - pin layout

Legend:

Pin		Description	Type
5	EXTERNAL OK KEY mode	Input for Remote control pedal	Input low: < 1 V d.c. against earth Input high: > 4.5 V d.c. against earth Umax: 24 V a.c, d.c against earth
6	IN_2	External input 2	
7	IN_3	External input 3	
8	IN_4	External input 4	
4	IN_5	External input 5	
9		GND	
3		Instrument reset pin	
1,2		Not supported	

8.8 OUTPUTs

Via the DB9 connector OUTPUT four control signals for external devices are provided.

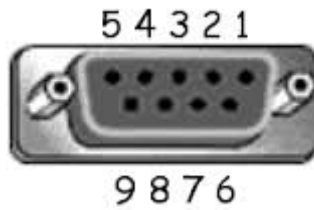

Figure 9.3: OUTPUT connector - pin layout

Legend:

Pins			Description	Type
4,9		OUT_1	Control output 1	NO relay, Umax: 24V, I _{max} : 1.5 A Output low: open contact Output high: closed contact
3,8		OUT_2	Control output 2	
2,7		OUT_3	Control output 3	
1,6		OUT_4	Control output 4	
5		+5 V	Supply for inputs	

9 Technical specifications

9.1 HV AC, HV AC programmable

Voltage a.c.

	Range	Resolution	Accuracy
U	0 V ... 1999 V	1 V	±(3 % of reading)
	2.00 kV ... 5.99 kV	10 V	±(3 % of reading)

Current a.c. (apparent)

	Range	Resolution	Accuracy
I	0.0 mA ... 99.9 mA	0.1 mA	±(3 % of reading + 3 D)

Current a.c.(capacitive, resistive)

	Range	Resolution	Accuracy
I _r	0.0 mA ... 99.9 mA	0.1 mA	Indicative
I _c	-99.9 mA ... 99.9 mA	0.1 mA	Indicative

Output voltage 100 V ... 1000 V (-0/+10%),
 1010 V ... 5000 V (-0/+5%) floating to earth
 Trip out time (if apparent current exceeds high limit)..... < 30 ms
 Short circuit current > 200 mA
 Output power.....500 VAm_{ax}

Test terminals

Function	Connections
Withstanding voltage (HVAC, HVAC-P)	HV(~,+) ↔ HV(~, -)

9.2 HV DC, HV DC programmable

Voltage d.c.

	Range	Resolution	Accuracy
U	0 V ... 1999 V	1 V	±(3 % of reading)
	2.00 kV ... 6.99 kV	10 V	±(3 % of reading)

Current d.c.

	Range	Resolution	Accuracy
I	0.01 mA ... 9.99 mA	0.01 mA	±(5 % of reading + 3 D)

Output voltage 500 V ... 1000 V (-0/+10%),
 1050 V ... 6000 V (-0/+5%) floating to earth
 Ripple voltage.....±3 %
 Trip out time (if current exceeds high limit)..... < 30 ms
 Max. capacitive load..... 2 μF

Test terminals

Function	Connections
Withstanding voltage (HVDC, HVDC-P)	HV(~,+) ↔ HV(~, -)

9.3 Continuity

Continuity

	Range	Resolution	Accuracy
R	0.000 Ω ... 1.999 Ω	0.001 Ω	±(2 % of reading + 2 D)
	2.00 Ω ... 19.99 Ω	0.01 Ω	± 2 % of reading
	20.0 Ω ... 99.9 Ω	0.1 Ω	± 3 % of reading
	100.0 Ω ... 199.9 Ω	0.1 Ω	± 5 % of reading
	200 Ω ... 999 Ω	1 Ω	indicative

Voltage drop (I_{out} = 10 A)

	Range	Resolution	Accuracy
ΔU	0.00 V ... 19.99 V	0.01 V	±(2 % of reading + 5 D)
	20.0 V ... 99.9 V	0.1 V	± 3 % of reading

Limit value of voltage drop versus wire cross-section:

Wire cross-section (mm ²)	Limit voltage drop (V)
0.5	5.0
0.75	5.0
1	3.3
1.5	2.6
2.5	1.9
4	1.4
≥6	1.0

Operating range (acc. to EN 61557-4) 0.008 Ω ... 199.9 Ω
 Test currents 0.2A, 4A, 10A, 25A
 Current source (at nominal mains voltage, use of standard accessories)
 0.2 A at R < 8 Ω
 4 A at R < 1 Ω
 10 A at R < 0.5 Ω
 25 A at R < 0.2 Ω
 Open circuit voltage < 6 V a.c.
 Max current lead resistance 40 Ω
 Test lead compensation (P/S – PE) up to 5 Ω
 Max. R compensation custom value up to 2 Ω
 Test method: Continuity 4 wire Kelvin method, floating to earth
 Test method: Continuity P/S – PE 2 wire test, floating to earth

Test terminals

Function	Connections
Continuity P/S – PE	P/S ↔ Mains test socket (PE), TC1
Continuity 4 wire	P1/C1 ↔ P2/C2

9.4 Insulation Resistance, Insulation Resistance-S

Insulation resistance (250 V, 500 V, 1000 V)

	Range	Resolution	Accuracy
Riso	0.00 MΩ ... 19.99 MΩ	0.01 MΩ	±(3 % of reading + 2 D)
	20.0 MΩ ... 199.9 MΩ	0.1 MΩ	± 10 % of reading

Insulation resistance, Insulation resistance –S (250 V, 500 V, 1000 V)

	Range	Resolution	Accuracy
Riso	0.00 MΩ ... 19.99 MΩ	0.01 MΩ	±(3 % of reading + 2 D)
Riso-S	20.0 MΩ ... 199.9 MΩ	0.1 MΩ	± 20 % of reading

Insulation resistance, Insulation resistance –S (50 V, 100 V)

	Range	Resolution	Accuracy
Riso	0.00 MΩ ... 19.99 MΩ	0.01 MΩ	±(5 % of reading + 2 D)
Riso-S	20.0 MΩ ... 99.9 MΩ	0.1 MΩ	± 20 % of reading

Output voltage

	Range	Resolution	Accuracy
Um	0 V ... 1200 V	1 V	±(3 % of reading + 2 D)

Operating range (acc. to EN 61557-2) 0.08 MΩ ... 199.9 MΩ
 Nominal voltages Un (d.c.) 50 V, 100 V, 250 V, 500 V, 1000V (- 0 %, + 10 %)
 Short circuit current max. 2.0 mA

Test terminals

Function	Connections
Insulation	Mains test socket (LN), ISO(+) ↔ Mains test socket (PE), ISO(-), TC1
Insulation – S	Mains test socket (LN), ISO(+) ↔ P/S, TC1

9.5 Substitute Leakage Current, Substitute Leakage Current - S**Substitute leakage current, Substitute leakage current - S**

	Range	Resolution	Accuracy
Isub Isub-S	0.00 mA ... 19.99 mA	10 μA	±(5 % of reading + 3 D)

Operating range (acc. to EN 61557-16) 0.12 mA ... 19.99 mA
 Open circuit voltage < 50 V a.c.
 Current calculated to mains supply voltage (110 V or 230 V) is displayed.

Test terminals:

Function	Connections
Subleakage	Mains test socket (LN), SUB1 ↔ Mains test socket (PE), SUB2, TC1
Subleakage – S	Mains test socket (LN), SUB1 ↔ P/S, TC1

9.6 Differential Leakage current**Differential leakage current**

	Range	Resolution	Accuracy
Idiff	0.00 mA ... 19.99 mA	0.01 mA	±(3 % of reading + 5 D)

Power (active)

	Range	Resolution	Accuracy
P	0.00 W ... 19.99 W	0.01 W	±(5 % of reading + 5 D)
	20.0 W ... 199.9 W	0.1 W	± 5 % of reading
	200 W ... 1999 W	1 W	± 5 % of reading
	2.00 kW ... 3.70 kW	10 W	± 5 % of reading

Operating range (acc. to EN 61557-16) 0.19 mA ... 19.99 mA
 Frequency response of measuring circuit complies with IEC 61010 - Figure A1
 Influence of load current < 0.02 mA/A

Test terminals:

Function	Connections
Differential leakage	Mains test socket (LN), TC1

9.7 PE leakage current

PE leakage current

	Range	Resolution	Accuracy
I _{pe} I _{pe} , a.c.	0.010 mA ... 1.999 mA	0.001 mA	±(3 % of reading + 3 D)
I _{pe} , d.c.	2.00 mA ... 19.99 mA	0.01 mA	±(3 % of reading)

Power (active)

	Range	Resolution	Accuracy
P	0.00 W...19.99 W	0.01 W	±(5 % of reading + 5 D)
	20.0 W...199.9 W	0.1 W	± 5 % of reading
	200 W ... 1999 W	1 W	± 5 % of reading
	2.00 kW ... 3.70 kW	10 W	± 5 % of reading

Operating range (acc. to EN 61557-16) 0.025 mA ... 19.99 mA

Frequency response of measuring circuit complies with IEC 61010 - Figure A1

Test terminals:

Function	Connections
PE leakage	Mains test socket, TC1

9.8 Touch leakage current

Touch leakage current

	Range	Resolution	Accuracy
I _{tou} I _{tou} , a.c.	0.010 mA ... 1.999 mA	0.001 mA	±(3 % of reading + 3 D)
I _{tou} , d.c.	2.00 mA ... 19.99 mA	0.01 mA	±(3 % of reading)

Power (active)

	Range	Resolution	Accuracy
P	0.00 W...19.99 W	0.01 W	±(5 % of reading + 5 D)
	20.0 W...199.9 W	0.1 W	± 5 % of reading
	200 W ... 1999 W	1 W	± 5 % of reading
	2.00 kW ... 3.70 kW	10 W	± 5 % of reading

Operating range (acc. to EN 61557-16) 0.025 mA ... 19.99 mA

Frequency response of measuring circuit complies with IEC 61010 - Figure A1

Output:

Function	Connections
Touch leakage	Mains test socket ↔ P/S, TC1

9.9 Power

Power (active)

	Range	Resolution	Accuracy
P	0.00 W...19.99 W	0.01 W	±(5 % of reading + 5 D)
	20.0 W...199.9 W	0.1 W	± 5 % of reading
	200 W ... 1999 W	1 W	± 5 % of reading
	2.00 kW ... 3.70 kW	10 W	± 5 % of reading

Power (apparent)

	Range	Resolution	Accuracy
S	0.00 VA...19.99 VA	0.01 VA	±(5 % of reading + 10 D)
	20.0 VA...199.9 VA	0.1 VA	± 5 % of reading
	200 VA ... 1999 VA	1 VA	± 5 % of reading
	2.00 kVA...3.70 kVA	10 VA	± 5 % of reading

Power (reactive)

	Range	Resolution	Accuracy
Q	0.00 VAR ... 19.99 VAR	0.01 VAR	±(5 % of reading + 10 D)
	20.0 VAR ... 199.9 VAR	0.1 VAR	± 5 % of reading
	200 VAR ... 1999 VAR	1 VAR	± 5 % of reading
	2.00 kVAR...3.70 kVAR	10 VAR	± 5 % of reading

Power factor

	Range	Resolution	Accuracy
PF	0.00i ... 1.00i 0.00c ... 1.00c	0.01	±(5 % of reading + 5 D)

Total Harmonic Distortion (voltage)

	Range	Resolution	Accuracy
THDU	0.0 % ... 99.9 %	0.1 %	±(5 % of reading + 5 D)

Total Harmonic Distortion (current)

	Range	Resolution	Accuracy
THDI	0 mA...999 mA	1 mA	±(5 % of reading + 5 D)
	1.00 A ... 16.00 A	10 mA	±(5 % of reading)

Cosinus Φ

	Range	Resolution	Accuracy
Cos Phi	0.00i ... 1.00i 0.00c ... 1.00c	0.01	±(5 % of reading + 5 D)

Voltage

	Range	Resolution	Accuracy
U	0.0 V ... 199.9 V	0.1 V	±(3 % of reading + 10 D)
	200 V ... 264 V	1 V	±3 % of reading

Current

	Range	Resolution	Accuracy
I	0 mA...999 mA	1 mA	±(3 % of reading + 5 D)
	1.00 A ... 16.00 A	10 mA	± 3 % of reading

Accuracy is valid within $0.5c \leq PF \leq 0.8i$

Test terminals:

Function	Connections
Power	Mains test socket, TC1

9.10 Leak's & Power**Power (active)**

	Range	Resolution	Accuracy
P	0.00 W...19.99 W	0.01 W	±(5 % of reading + 5 D)
	20.0 W...199.9 W	0.1 W	± 5 % of reading
	200 W ... 1999 W	1 W	± 5 % of reading
	2.00 kW ... 3.70 kW	10 W	± 5 % of reading

Power (apparent)

	Range	Resolution	Accuracy
S	0.00 VA...19.99 VA	0.01 VA	±(5 % of reading + 10 D)
	20.0 VA...199.9 VA	0.1 VA	± 5 % of reading
	200 VA ... 1999 VA	1 VA	± 5 % of reading
	2.00 kVA...3.70 kVA	10 VA	± 5 % of reading

Power (reactive)

	Range	Resolution	Accuracy
Q	0.00 VAr ... 19.99 VAr	0.01 VAr	±(5 % of reading + 10 D)
	20.0 VAr ... 199.9 VAr	0.1 VAr	± 5 % of reading
	200 VAr ... 1999 VAr	1 VAr	± 5 % of reading
	2.00 kVAr ... 3.70 kVAr	10 VAr	± 5 % of reading

Power factor

	Range	Resolution	Accuracy
PF	0.00i ... 1.00i 0.00c ... 1.00c	0.01	±(5 % of reading + 5 D)

Total Harmonic Distortion (voltage)

	Range	Resolution	Accuracy
THDU	0.0 % ... 99.9 %	0.1 %	±(5 % of reading + 5 D)

Total Harmonic Distortion (current)

	Range	Resolution	Accuracy
THDI	0 mA...999 mA	1 mA	±(5 % of reading + 5 D)
	1.00 A ... 16.00 A	10 mA	±(5 % of reading)

Cosinus Φ

	Range	Resolution	Accuracy
Cos Phi	0.00i ... 1.00i 0.00c ... 1.00c	0.01	±(5 % of reading + 5 D)

Voltage

	Range	Resolution	Accuracy
U	0.0 V ... 199.9 V	0.1 V	±(3 % of reading + 10 D)
	200 V ... 264 V	1 V	±3 % of reading

Current

	Range	Resolution	Accuracy
I	0 mA...999 mA	1 mA	±(3 % of reading + 5 D)
	1.00 A ... 16.00 A	10 mA	± 3 % of reading

Differential leakage current

	Range	Resolution	Accuracy
Idiff	0.00 mA ... 19.99 mA	0.01 mA	±(3 % of reading + 5 D)

Operating range (acc. to EN 61557-16) 0.19 mA ... 19.99 mA

Frequency response of measuring circuit..... complies with IEC 61010 - Figure A1

Influence of load current..... < 0.02 mA/A

Accuracy is valid within $0.5c \leq PF \leq 0.8i$

Touch leakage current

	Range	Resolution	Accuracy
Itou Itou, a.c. Itou, d.c.	0.010 mA ... 1.999 mA	0.001 mA	±(3 % of reading + 3 D)
	2.00 mA ... 19.99 mA	0.01 mA	±(5 % of reading)

Operating range (acc. to EN 61557-16) 0.025 mA ... 19.99 mA

Frequency response of measuring circuit..... complies with EN 61010 - Figure A1

Test terminals:

Function	Connections
Power	Mains test socket, TC1
Differential leakage	Mains test socket (LN), TC1
Touch leakage	Mains test socket ↔ P/S, TC1

9.11 Discharging time

Discharging time

	Range	Resolution	Accuracy
t	0.0 s ... 60.0 s	0.1 s	±(5 % of reading + 2 D)

Measuring range (acc. to EN 61557-14) 2.0 s ... 60.0 s

Residual voltage

	Range	Resolution	Accuracy
U _{res}	0.0 V ... 99.9 V	0.1 V	±(5 % of reading + 3 D)
	100 V ... 550 V	1 V	

Measuring range (acc. to EN 61557-14) 3.0 V ... 550 V

Peak voltage

	Range	Resolution	Accuracy
U _p	0 V ... 550 V	1 V	±(5 % of reading + 3 D)

RMS voltage

	Range	Resolution	Accuracy
U	80.0 V ... 99.9 V	0.1 V	±(2 % of reading + 2 D)
	100 V ... 550 V	1 V	

Frequency

	Range	Resolution	Accuracy
Freq	45.0 Hz ... 65.0 Hz	0.1 Hz	±(0.2 % of reading + 1 D)

Nominal frequency range d.c., 45 Hz – 65 Hz

High limits 1 s, 5 s, 60 s

Threshold voltage 34 V, 50 V, 60 V, 120 V

Input resistance (Output = Socket) 96 MΩ

Input resistance (Output = External) 96 MΩ (if DUT is not earthed after disconnection)

..... 48 MΩ (if DUT is earthed after disconnection)

Max. load current (Output = Socket) 10 A

Automatic disconnection at U_{LN,peak} if DUT (Device Under Test) is connected to mains test socket.

Test terminals

Function	Connections
Discharging time External	DISCH1 ↔ DISCH2
Discharging time Socket	Mains test socket (L,N), TC1

9.12 General data

Power supply

Supply voltage, frequency 110 V / 230 V AC, 50 Hz / 60 Hz

Supply voltage tolerance ±10 %

Max. power consumption 600 W (without load on mains test socket)

Max. power consumption 4.5 kW (with load on mains test socket)

Mains supply overvoltage category CAT II / 300V

Altitude ≤ 2000 m

Measuring categories

DISCH1 / DISCH2	CAT II / 600 V
ISO(+) SUB1 / ISO(-) SUB2	CAT II / 300 V
P1, C1 / P2, C2	CAT II / 300 V
P/S	CAT II / 300 V
TC1	CAT II / 300 V
Mains test socket.....	CAT II / 300 V
Altitude	≤ 2000 m

Protection classifications

Power supply.....	Class I
HV output.....	5 kV a.c. / 6 kV d.c., double insulation
Pollution degree	2
Degree of protection.....	IP 50 (closed case)
.....	IP 40 (open case)
.....	IP 20 (mains test socket)
Case.....	Shock proof plastic / portable
INPUTs.....	24 Vmax, earthed
OUTPUTs.....	24 Vmax, earthed
Display	Colour TFT display, 4.3 inch, 480 x 272 pixels
Touch screen.....	Capacitive

Communication

Memory	depends on microSD card size
RS232 interfaces.....	two DB9 ports
USB 2.0.....	Standard USB Type B
Bluetooth	Class 2
Ethernet.....	Dynamic IP (DHCP)
.....	Static IP (manual)

I/Os

Inputs	DB9 connector (24 V max)
Outputs.....	DB9 connector (NO relays, 24 V max, 1.5 A max)
Dimensions (w×h×d):	43.5 cm × 29.2 cm × 15.5 cm
Weight	approximately 17 kg

EMC

Emission.....	Class B (portable equipment used in controlled EM environments: domestic, commercial, light industry)
Immunity.....	Industrial environment

Reference conditions

Reference temperature range:	15 °C ... 35 °C
Reference humidity range:	35 % ... 65 % RH

Operation conditions

Working temperature range:.....	0 °C ... +40 °C
Maximum relative humidity:.....	85 % RH (0 °C ... 40 °C), non-condensing
Operation.....	Indoor use

Storage conditions

Temperature range:.....	-10 °C ... +60 °C
Maximum relative humidity:.....	90 % RH (-10 °C ... +40 °C)
.....	80 % RH (40 °C ... 60 °C)

Accuracies apply for 1 year in reference conditions. Temperature coefficient outside these limits is 0.2 % of measured value per °C plus 1 digit, otherwise noted.

Fuses

2 x T 16 A / 250 V, 32 mm × 6.3 mm / 1500 A (protection of mains test socket)
2 x T 5 A / 250 V, 20 mm × 5 mm / 1500 A (instrument protection)

10 Maintenance

Except for the fuse, the instrument contains no parts that can be replaced by personnel who have not been specially trained and accredited. Any unauthorized repair or replacement of a part by an "equivalent" may gravely impair safety.

10.1 Fuses

There are four fuses on the front panel:

F1, F2: F 5 A / 250 V / (20 × 5) mm / 1500 A: intended for instrument protection.
For position of fuses refer to chapter 3.1 *Front panel*.

F3, F4: T 16 A / 250 V / (32 × 6,3) mm / 1500 A: protection against over-currents through mains test socket.
For position of fuses refer to chapter 3.1 *Front panel*.

Warnings!

- › Switch off the instrument and disconnect all test accessories and mains cord before replacing the fuses or opening the instrument.
- › Replace blown fuses only with the same types defined in this document.

10.2 Cleaning

Use a soft, slightly moistened cloth with soap water or alcohol to clean the surface of C.A 6165 instrument. Leave the instrument to dry totally before using it.

Notes:

- › Do not use liquids based on petrol or hydrocarbons!
- › Do not spill cleaning liquid over the instrument!

11 Warranty

Except as otherwise stated, our warranty is valid for **24 months** starting from the date on which the equipment was sold. The extract from our General Conditions of Sale is available on our website.











www.chauvin-arnoux.com/en/general-terms-of-sale

The warranty does not apply in the following cases:

- Inappropriate use of the equipment or use with incompatible equipment;
- Modifications made to the equipment without the explicit permission of the manufacturer's technical staff;
- Work done on the device by a person not approved by the manufacturer;
- Adaptation to a particular application not anticipated in the definition of the equipment or not indicated in the user's manual;
- Damage caused by shocks, falls, or floods.

Appendix A - Structure objects in C.A 6165

Structure elements used in Memory Organizer are instrument's Profile dependent.

Symbol	Default name	Description
	Node	Node
	Project	Project
	Location	Location
	Element	Universal element
	Appliance	Appliance (basic description)
	Appliance FD	Appliance (full description)
	Machine	Electrical machine
	Switchgear	Switchgear
	Level1	1st sub-level of machine / switchgear
	Level 2	2nd sub-level of machine / switchgear
	Level 3	3rd sub-level of machine / switchgear

***Appendix B* - Profile Notes**

There are no specific profile notes for C.A 6165 .

Appendix C - Print labels and write / read RFID / NFC tags

The instrument supports different printers and two tag formats (PAT and Generic); listed parameters setting is described in chapter 4.6.9 *Devices*.

Tag content can be presented as text only or arranged as text area and machine-readable code area – QR code – in addition.

The instrument supports RFID / NFC reader / writer device, tag type supported is NTAG216.

Please check with Chauvin Arnoux or distributor which printers and labels are supported in your instrument.

C.1 PAT tag format

It is intended for tagging of individual appliance with Auto Sequence® test data. To start printing, Auto Sequence® should be finished and saved or reopened from memory structure.

Label type is simple, containing text area only, available data are:

- › Appliance ID
- › Appliance name
- › Test date
- › Retest date
- › Auto Sequence® test status
- › User name (who currently performed test or who performed saved test, if printed from memory)

Following table describe tag content arrangement and its data for supported form size and chosen label type.

Label type	Form size W x H (mm)	Tag content arrangement	Label data
Simple	50x25,5	Text	Appliance ID, appliance name, test status, test or retest date, user name

Notes:

- › Data not available will not be printed on the label.
- › Test or Retest date: it is set in the General Settings => Devices => Writing devices menu.
- › If Auto Sequence® was modified, its short code is marked with asterisk (*).

C.2 Generic tag format

It is intended for tagging structure objects which could be tested. In addition to test result data, test object location within structure is marked. Label printing can be started from selected structure object even if no Auto Sequence® is associated with it, or from finished Auto Sequence® saved under it.

Tag data presented in text area are:

- › Parent structure object ID (name) (← Object_name)
- › Auto Sequence® short test code (if printing from Auto Sequence®; if printing from object field is omitted)
- › Object ID (name)
- › Test date (|→ DD.MM.YYYY) or Retest date (→| DD.MM.YYYY), which one is selected in General Settings => Devices => Writing devices menu
- › Status (printing from object: overall status of all tests appended to the object or sub-structure objects; printing from Auto Sequence®: its status)
- › User name (Printing from Auto Sequence: user who performed test; printing from object: current signed-in user)

Tag data presented in machine-readable area are:

- › Parent structure object ID (name)
- › Auto Sequence® short test code (if printing from Auto Sequence®; if printing from object field is omitted)
- › Object ID (name)
- › Test date
- › Test period (from appliance description)
- › Auto Sequence® status (field is omitted, if not printing from Auto Sequence®)
- › Object status (overall status of all tests appended to the object or sub-structure objects)
- › User name (Printing from Auto Sequence®: user who performed test; printing from object: currently signed-in user)

Following table describes tag content arrangement and its data for supported label form size.

Form size W x H (mm)	Tag content arrangement	Data
50 x 25.5	Text	Parent object name, Test code, Object ID, test or retest date, status, user
	QR	Parent object name, Test code, Object ID, test date, test period, Auto Sequence® status, Object status, user.

Notes:

- › Data not available will not be printed on the label.
- › Object without appended Auto Sequence® test has no status!
- › If Auto Sequence® was modified, its short code is marked with asterisk (*).
- › Object status depends on all measurements (Auto Sequences® or Single tests) appended to the object or sub-structure objects, see chapter 5.1.2.1 *Measurement status indication under the Structure object* for details.

Following table describes data content written on RFID / NFC tag.

RFID / NFC tag type	Data
NTAG216	Parent object name, Test code, Object ID, test date, test period, Auto Sequence® status, Object status, user.

Appendix D - Default list of Auto Sequences®

Pre-programmed DEMO Auto Sequences®

<i>No.</i>	<i>Name</i>	<i>Description</i>
1	DEMO_1	This Auto Sequence® is just for demonstration of manipulation of Auto Sequence® operation.
2	DEMO_2	This Auto Sequence® is just for demonstration of manipulation of Auto Sequence® operation.

Appendix E - Programming of Auto Sequences® on MTLink

The Auto Sequence® Editor is a part of the MTLink software. In Auto Sequence® Editor, Auto Sequences® can be pre-programmed and organized in groups, before uploaded to the instrument.

E.1 Auto Sequence® Editor workspace

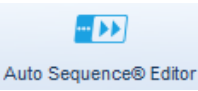
To enter Auto Sequence® editor's workspace, select  in Home Tab of MTLinkPC SW. Auto Sequence® editor workspace is divided in four main areas. On the left side **1**, structure of selected group of Auto Sequence® is displayed. In the middle part of the workspace **2**, the elements of the selected Auto Sequence® are shown. On the right side, list of available single tests **3** and list of flow commands **4** are shown. Single test area contains three tabs, Measurements Inspections and Custom Inspections tab. Custom Inspections and their tasks are programmed by user.

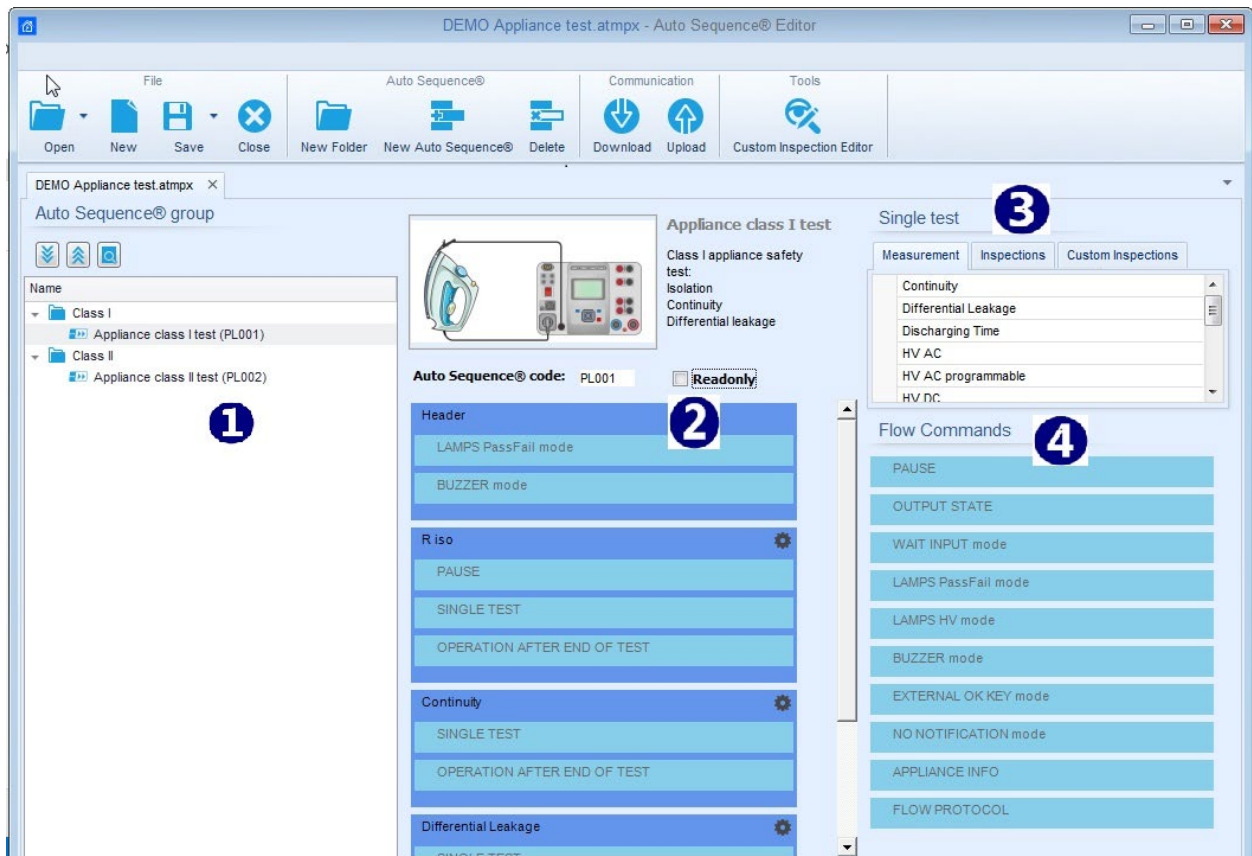

Figure E.1: Auto Sequence® editor workspace

An Auto Sequence[®] **2** begins with Name, Description and Image, followed by the first step (Header), one or more measuring steps and ends with the last step (Result). By inserting appropriate Single tests **3** and Flow commands **4** and setting their parameters, arbitrary Auto Sequences[®] can be created.



Figure E.2: Example of an Auto Sequence[®] header

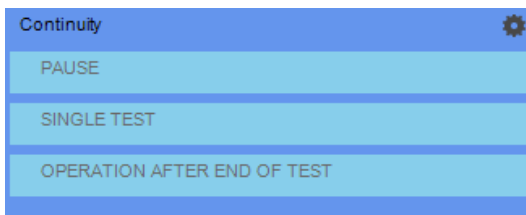

Figure E.3: Example of a measurement step



Figure E.4: Example of an Auto Sequence[®] result

E.2 Managing of Auto Sequence[®] groups

The Auto Sequences[®] can be divided into different user defined Auto Sequence[®] groups. Each Auto Sequence[®] group is stored in a file. More files can be opened simultaneously in Auto Sequence[®] editor. Within Auto Sequence[®] Group, tree structure can be organized, with folders / subfolders containing Auto Sequences[®]. The three structure of currently active Auto Sequence[®] Group is displayed on the left side of the Auto Sequence[®] editor workspace, see *Figure E.5*.

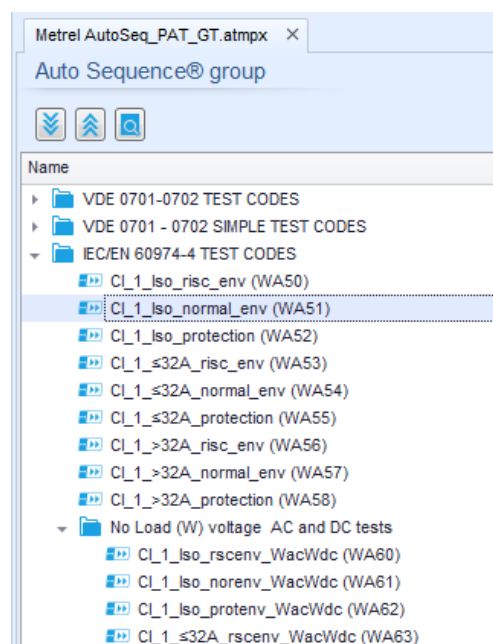









Figure E.5: Auto Sequence[®] Group tree organization

Operation options on Files and Auto Sequence® Group are available from menu bar at the top of Auto Sequence® editor workspace.



File operation options:

	Opens a file (Auto Sequence® Group).
	Creates a new file (Auto Sequence® Group).
	Saves / Saves as the opened Auto Sequence® Group to a file.
	Closes the file (Auto Sequence® Group).





Group of Auto Sequences® view options:

	Expand all folders / subfolders / Auto Sequences®.
	Collapse all folders / subfolders / Auto Sequences®.
	Toggle between Search by name within Auto Sequence® group and normal view. See chapter E.2.2 <i>Search within selected Auto Sequence® group</i> for details.

Auto Sequence® Group operation options (also available by right clicking on Folder or Auto Sequence®):

	Adds a new folder / subfolder to the group.
	Adds a new Auto Sequence® to the group.
	Deletes: <ul style="list-style-type: none"> - the selected Auto Sequence® - the selected folder with all subfolders and Auto Sequences®



Right click on the selected Auto Sequence® or Folder opens menu with additional possibilities:

	Auto Sequence®: Edit Name, Description and Image (see <i>Figure E.6</i>). Folder: Edit folder name
	Auto Sequence®: Copy to clipboard Folder: Copy to clipboard including subfolders and Auto Sequences®
	Auto Sequence®: Paste it to selected location Folder: Paste it to selected location
	Auto Sequence®: Create shortcut to selected Auto Sequence®

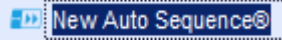
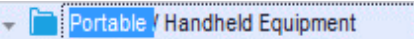
Double click on the object name allows it name edit:

DOUBLE CLICK	<p>Auto Sequence® name: Edit Auto Sequence® name</p>  <p>Folder name: Edit folder name</p> 
--------------	---

Drag and drop of the selected Auto Sequence® or Folder / Subfolder moves it to a new location:

DRAG & DROP	<p>“Drag and drop” functionality is equivalent to “cut” and “paste” in a single move.</p> <ul style="list-style-type: none">  move to folder  insert
-------------	--



E.2.1 Auto Sequence® Name, Description and Image editing

When EDIT function is selected on Auto Sequence®, menu for editing presented on *Figure E.6* appear on the screen. Editing options are:

Name: Edit or change the name of Auto Sequence®.

Description: Any text for additional description of Auto Sequence® can be entered.

Image: Image presenting Auto Sequence® measuring arrangement can be entered or deleted.

	Enters menu for browsing to Image location.
	Deletes the Image from Auto Sequence®.

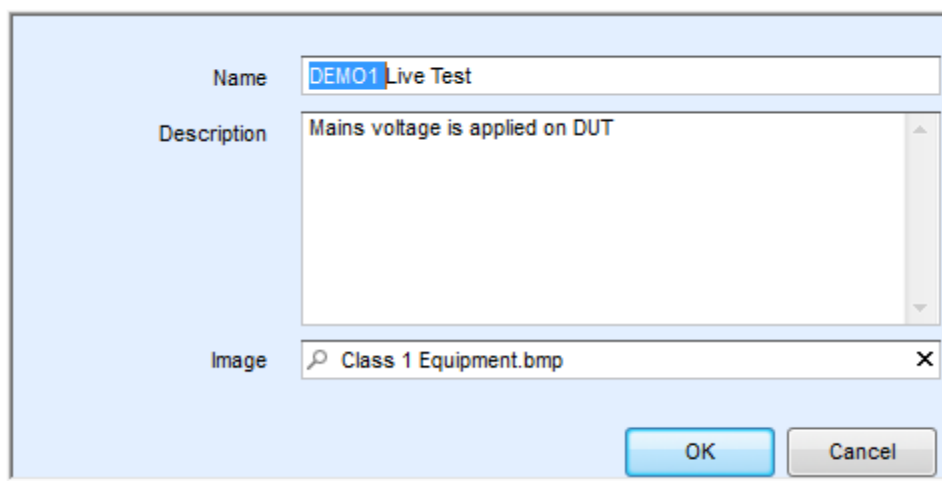



Figure E.6: Editing the Auto Sequence® Name, Description and Image

E.2.2 Search within selected Auto Sequence® group

When  function is selected, Search menu as presented on *Figure E.7* appear on the screen. By entering the text into search box, found results are automatically highlighted with yellow background. Search functionality is implemented in Folders, Subfolders and Auto Sequences® of selected Auto Sequence® Group. Search functionality is case sensitive. Search text can be cleared by selecting the Clear button.

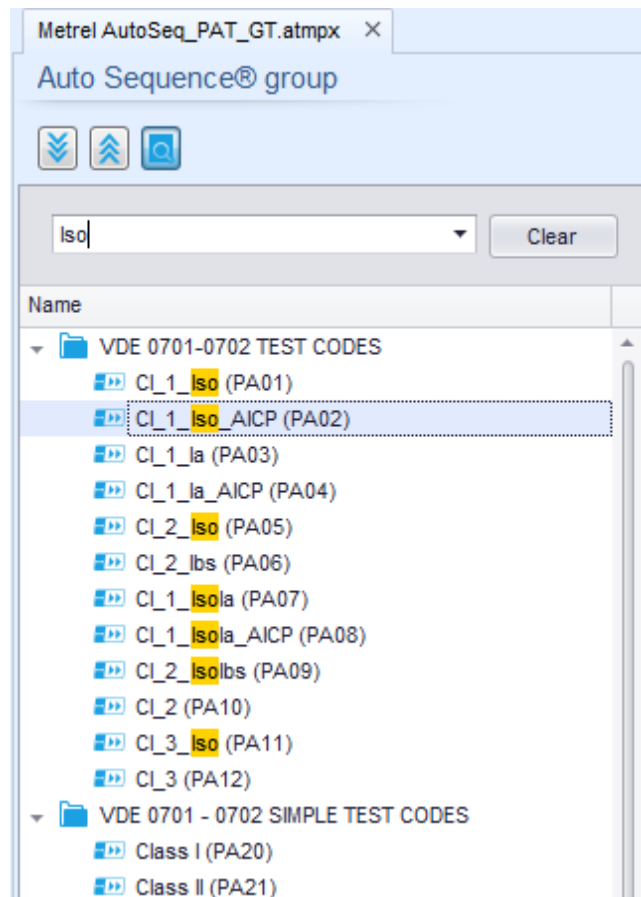

Figure E.7: Example of Search result within Auto Sequence® group

E.3 Elements of an Auto Sequence®

E.3.1 Auto Sequence® steps

There are three kinds of Auto Sequence® steps.

Header

The Header step is empty by default.
Flow commands can be added to the Header step.

Measurement step

The Measurement step contains a Single test and the Operation after end of test flow command by default. Other Flow commands can also be added to the Measurement step.

Result

The Result step contains the Result screen flow command by default. Other Flow commands can also be added to the Result step.

E.3.2 Single tests

Single tests are the same as in MTLINKMeasurement menu.
Limits and parameters of the measurements can be set. Results and sub-results can't be set.

E.3.3 Flow commands

Flow commands are used to control the flow of measurements. Refer to chapter *E.5 Description of flow commands* for more information.



E.3.4 Number of measurement steps

Often the same measurement step has to be performed on multiple points on the device under test. It is possible to set how many times a Measurement step will be repeated. All carried out individual Single test results are stored in the Auto Sequence® result as if they were programmed as independent measuring steps.

E.4 Creating / modifying an Auto Sequence®

If creating a new Auto Sequence® from scratch, the first step (Header) and the last step (Result) are offered by default. Measurement steps are inserted by the user.

Options:

Adding a measurement step	By double clicking on a Single test a new measurement step will appear as the last of measurement steps. It can also be dragged and dropped on the appropriate position in the Auto Sequence®.
Adding flow commands	Selected flow command can be dragged from the list of Flow commands and dropped on the appropriate place in any Auto Sequence® step.
Changing position of flow command within measurement step	By a click on an element and use of  ,  keys.
Viewing / changing parameters of flow commands or single tests.	By a double click on the element.
Setting number of measurement step repetitions	By setting a number in the  field. Note: Up to 999 step repetitions can be set.

Right click on the selected measurement step / flow command:

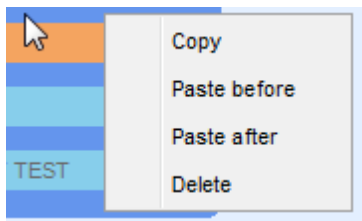
	<p>Copy – Paste before A measurement step / flow command can be copied and pasted above selected location on the same or on another Auto Sequence®.</p> <p>Copy – Paste after A measurement step / flow command can be copied and pasted under selected location on the same or on another Auto Sequence®.</p> <p>Delete Deletes the selected measurement step / flow command.</p>
---	---

E.5 Description of flow commands

Double click on inserted Flow Command opens menu window, where text or picture can be entered, external signalling and external commands can be activated and parameters can be set.

Flow commands Operation after end of test and Results screen are entered by default, others are user selectable from Flow Commands menu.

Pause

A Pause command with text message or picture can be inserted anywhere in the measuring steps. Warning icon can be set alone or added to text message. Arbitrary text message can be entered in prepared field Text of menu window.

Parameters:

Pause type	Show text and/or warning (<input checked="" type="checkbox"/> check to show warning icon) Show picture (<input type="text"/> browse for image path)
Duration	Number in seconds, infinite (no entry)

Output state

Sets outputs OUT_1, OUT_2, OUT_3, and OUT_4 on OUTPUT port.

Following settings of this command are ignored:

- › OUT_1 and OUT_2 while Lamps HV mode is enabled.
- › OUT_3 and OUT_4 while Lamps Pass / Fail mode is enabled.

All outputs are single normally opened relay contacts if not checked in Menu Output pins window.

Parameters:

<input checked="" type="checkbox"/> OUT_1	Set closed relay contact between OUTPUT pins 4 and 9
<input checked="" type="checkbox"/> OUT_2	Set closed relay contact between OUTPUT pins 3 and 8
<input checked="" type="checkbox"/> OUT_3	Set closed relay contact between OUTPUT pins 2 and 7
<input checked="" type="checkbox"/> OUT_4	Set closed relay contact between OUTPUT pins 1 and 6
<input checked="" type="checkbox"/> OUT_5 <input checked="" type="checkbox"/> OUT_6 <input checked="" type="checkbox"/> OUT_7 <input checked="" type="checkbox"/> OUT_8	Applicable only when using CE Adapter

Wait input mode

Reads input condition on pins IN_2, IN_3, IN_4 and IN_5 on INPUT port. Input must be high to proceed with the Auto Sequence®.

Parameters

State	On – enables Wait input mode; set active INPUT from Input pins menu Off – disables Wait input mode
<input checked="" type="checkbox"/> IN_2	IN_2 reading condition on INPUT pin 6 is active
<input checked="" type="checkbox"/> IN_3	IN_3 reading condition on INPUT pin 7 is active
<input checked="" type="checkbox"/> IN_4	IN_4 reading condition on INPUT pin 8 is active
<input checked="" type="checkbox"/> IN_5	IN_5 reading condition on INPUT pin 4 is active

Lamps HV mode

Drives external lamps through OUT_1 and OUT_2 outputs. Works only in HV & HV programmable functions.

- › Green lamp (OUT_2) ON means that the instrument is ready for HV test. Green lamp turns on before first flow command in step that contains HV test. It remains ON, if input conditions are not fulfilled to start the HV measurement. Green lamp turns off during HV measurement and after end of the HV test.
- › Red lamp (OUT_1) ON means that dangerous voltage is present at WITHSTANDING (HV(~+)) and HV(~-) test terminals. Red lamp turns on before the measurement and turns off after the measurement.

While Lamps HV mode command is enabled the settings of Drive output command for OUT_1 and OUT_2 is ignored.

Parameters

State	On – enables Lamps HV mode Off – disables Lamps HV mode
-------	--

Lamps Pass / Fail mode

Drives external lamps through OUT_3 and OUT_4 outputs.

During measurement the lights reflect status icon in single test.

After measurement

- › Blue lamp (OUT_3) lights ON when test has passed. Lamp is lit until next step is started.
- › Yellow lamp (OUT_4) lights ON when test has failed. Lamp is lit until next step is started.
- › Lights turn off at the beginning of next step.

While Lamps Pass / Fail mode command is enabled the settings of Drive output command for OUT_3 and OUT_4 is ignored.

Parameters

State	On – enables Lamps Pass / Fail mode Off – disables Lamps Pass / Fail mode
-------	--

Buzzer mode

Passed or failed measurement is indicated with beeps.

- › Pass – double beep after the test
- › Fail – long beep after the test

Beep happens right after single test measurement.

Parameters

State	On – enables Buzzer mode Off – disables Buzzer mode
-------	--

External TEST / OK key mode

Instrument enables external TEST / OK key (OK / ENTER / TEST / HV TEST) by activating INPUT pin 5 reading condition. Functionality of the EXTERNAL OK KEY mode is the same as of the OK / ENTER / TEST / HV TEST key.

Parameters

State	On – enables External TEST / OK key mode (INPUT pin 5 is active) Off – disables External TEST / OK key mode
-------	--

No notifications mode

Instrument skips pre-test warnings (see C.A 6165 User Manual, chapter 4.4 *Symbols and messages* for more information).

Parameters

State	On – enables No notifications mode Off – disables No notifications mode
-------	--

Appliance info

Instrument enables to automatically add the appliance name to the Auto Sequence®.

Parameters

Repeat Setting	Repeat:	The same Appliance ID will be offered each time if the same Auto Sequence® is carried out successively in a loop.
	Increment:	A four digit number will be added to the Appliance ID and incremented each time if the same Auto Sequence® is carried out successively in a loop.
Appliance type	Selects the type of the appliance (Appliance, Appliance_FD)	
Default Appliance ID	Enter default Appliance ID	
Appliance name	Enter Appliance name. Options: <input checked="" type="checkbox"/> Editable – allows Appliance name to be modified while running Auto Sequence®. Menu with a list of Appliance names and possibility to enter custom Appliance name is offered within the test. <input type="checkbox"/> Not editable – Default Appliance name is used. Appliance name cannot be modified while running Auto Sequence®.	
Retest period	Retest period in months. Options: <input checked="" type="checkbox"/> Editable – allows Retest period to be modified while running Auto Sequence®. Numeric keypad for entering custom Retest period is offered within the test. <input type="checkbox"/> Not editable – Default Retest period is used. Retest period cannot be modified while running Auto Sequence®.	

Note

- This flow command is active only if Auto Sequence® is started from the Auto Sequences® Main menu.

Inspection Expert mode

If Inspection Expert mode flow command is set, the Visual inspection screen and Functional inspection screen within Auto Sequence® are displayed for 1 second and an overall PASS is automatically applied at the end of test. In between, the automatic procedure can be stopped and statuses can be applied manually.

Inspection Expert mode is disabled by default.

Parameters

State	On – enables automatic settings of tickers in Visual and Functional tests. Off – disables automatic settings of tickers in Visual and Functional tests.
-------	--

Flow Protocol

This flow command controls commands for communication with external device for the control of the flow of Auto Sequence®.

Parameters

Communication settings	Selects the port for communication with the external device. - RS232(PC) - USB	
Flow settings	Commands for communication with external device (industrial PC for example)	
	<input checked="" type="checkbox"/> Proceed	Send string: Proceed Description: If Proceed Flow setting is enabled, implementation of Auto Sequence® on instrument can be automatically controlled by external device by using Proceed string command. Command works in parallel with OK / ENTER / TEST / HV TEST keys and the EXTERNAL TEST / OK key mode. Proceed Flow setting is disabled by default.
	<input checked="" type="checkbox"/> End + Status	Received strings: End - pass End - fail End - none End - empty Description: Instrument sends string to external device at the end of each Measurement step. End + Status Flow setting is disabled by default.
<input checked="" type="checkbox"/> Alarm	Received string: Alarm Description: Instrument sends "Alarm" string to external device if "empty" status is detected and if both conditions -"Fail" status at the end of measurement step and flow command OPERATION AFTER END OF TEST – fail is set to "manual". Alarm Flow setting is disabled by default.	

Operation after end of test

This flow command controls the proceeding of the Auto Sequence® in regard to the measurement results.

Parameters

Operation after end of test – pass – fail – no status	The operation can be individually set for the case the measurement passed, failed or ended without a status.	
	Manual:	The test sequence stops and waits for appropriate command (TEST key, external command...) to proceed.
	Auto:	The test sequence automatically proceeds.

Result screen

This flow command controls the proceeding after the Auto Sequence® has ended.

Parameters

<input checked="" type="checkbox"/> Auto Save	Auto Sequence® results are stored in the momentary workspace. A new Node with the month and year will be created. Under the Node Auto Sequence® results or (if Appliance info flow command is set) a new appliance and Auto Sequence® results will be stored. Up to 100 Auto Sequence® results or appliances can be automatically stored under the same node. If more results / appliances are available, they are split to multiple nodes. Local Save Flow setting is disabled by default.
<input checked="" type="checkbox"/> Auto Print	Auto Sequence® results are automatically printed.

Notes

- This flow command is active only if Auto Sequence® is started from the Auto Sequences® Main menu (not from Memory organizer).

E.6 Custom Inspections programming

Arbitrary set of tasks dedicated to specific user defined Inspections can be programmed with application of Custom Inspection Editor Tool, accessible from Auto Sequence® Editor workspace. Custom Inspections are stored in dedicated file *.indf with user defined name. For application of Custom Inspections as a single test within Auto Sequence® group, appropriate file containing specific Custom Inspection should be opened first.

E.6.1 Creating and editing Custom Inspections

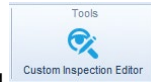

Custom Inspection Editor workspace is entered by selecting Custom Inspection Editor icon from Auto Sequences® main menu. It is divided in two main areas, as presented on *Figure E.8: Custom Inspection Editor workspace*.

- 1 Custom Inspection **Name** and **Scope** of inspection (Visual or Functional)
- 2 **Name** of Custom Inspection Item tasks and **Type** of Item Pass / Fail checkbox marking

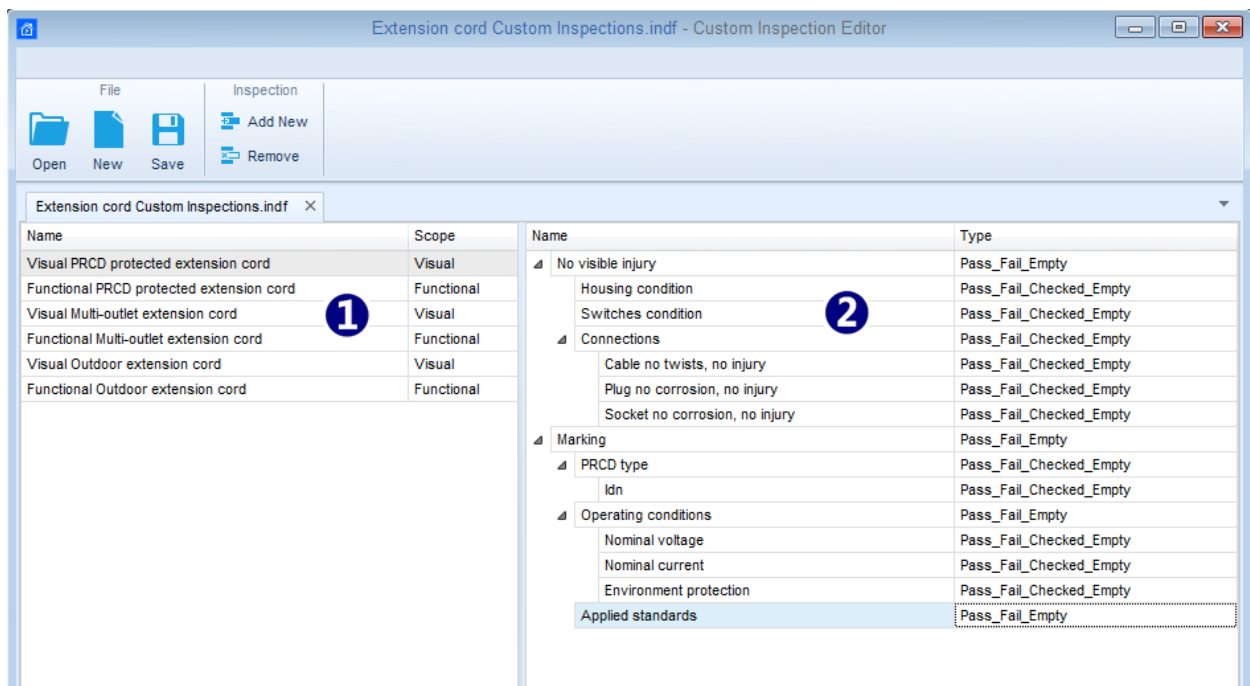





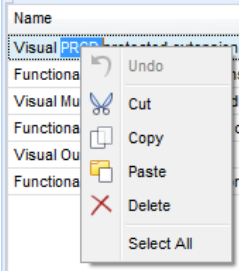
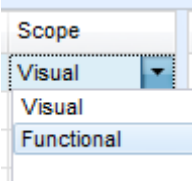

Figure E.8: Custom Inspection Editor workspace

Custom Inspection Editor Main menu options:

	Opens existing Custom Inspection Data file. By selecting, menu for browsing to location of *.indf file containing one or more Custom Inspections data appear on the screen. Selected file is opened in dedicated tab marked with file name.
	Creates a new Custom Inspection Data file. New tab with empty workspace is opened. Default name of the new tab is <i>Inspection Data File</i> ; it could be renamed during Save procedure.
	Saves / Saves as Custom Inspection Data file opened on active tab. Menu for browsing to the folder location and editing of file name is opened. Browse to the location, confirm overwriting, if file already exists or edit file name to save it as a new Custom Inspection Data file.
	Add New Custom Inspection. New inspection with default name <i>Custom Inspection</i> and default scope <i>Visual</i> appear on the editor workspace. It contains one Item task with default name <i>Custom Inspection</i> and default Type <i>Pass_Fail_Checked_Empty</i> . Default Name and Type can be edited – changed.
	Remove selected custom inspection. To select inspection, click to the inspection Name field. To remove it, select icon from editor main menu. Before removal, user is asked to confirm deletion.

Edit Name and Scope of Inspection

	Inspection Name edit: Click to the Inspection Name field to start editing it. Drag cursor, with left mouse button pressed, to select letters and words. Position cursor and double-click to select word of the name. Actions could be performed with keyboard also. Press right mouse button to activate Edit menu and select appropriate action as presented on the left figure. Menu is case sensitive; options currently not available are greyed out.
	Inspection Scope edit: Click to Inspection Scope field to open selection menu presented on left figure. Options: Visual is intended for observation of test object Functional allows functional test of observed object

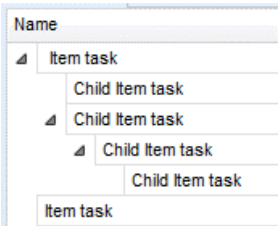
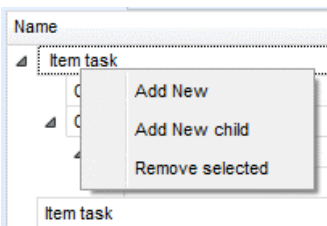

Edit Item task structure of Inspection

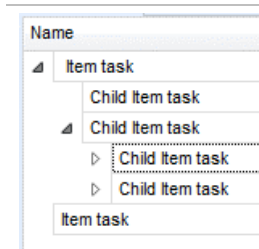
	Item tasks of the selected Inspection are listed in Name column on the right side of Editor workspace. Each Item task can have Child Item tasks, Child Item can have its own Child Item tasks and so on. Arbitrary tree structure of Item tasks and subtasks can be built as presented on left figure.
	ADD New Item task procedure: Position cursor above Item task Name and apply right mouse click to select Item task and open menu with options: Add New: new Item task is added on the top tree level Add New Child: new child Item task is added under selected Item Remove selected: delete selected Item task with all subtasks Default Name of New Item task is <i>Custom Inspection</i> , default Type <i>Pass_Fail_Checked_Empty</i> and both can be edited – changed.



Item tasks containing Child Item tasks are marked with triangle in front of their Name.

Click on triangle mark:

-  collapse Item task tree structure
-  expands Item task tree structure

Edit Name and Type of Item task

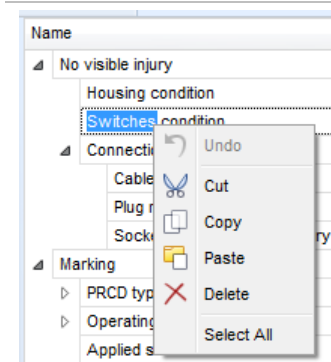

Edit Name of Item task:

Click to the Item task Name field to start editing it.

Drag cursor, with left mouse button pressed, to select letters and words. Position cursor and double-click to select word of the name. Actions could be performed with keyboard also.

Press right mouse button to activate Edit menu and select appropriate action as presented on the left figure. Menu is case sensitive; options currently not available are greyed out.

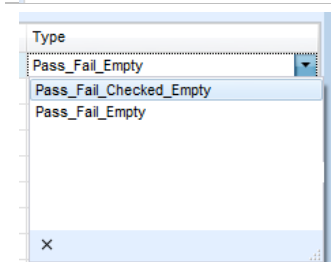

Edit Type of Item task:

Click to Item Type field to open selection menu presented on left figure. Selectable checkbox status assignment options are:

Pass_Fail_Checked_Empty: Pass, Fail, Checked, Empty (default)

Pass_Fail_Empty: Pass, Fail selection, Empty (default) value

E.6.2 Applying Custom Inspections

Custom inspections can be applied in Auto Sequences®. Direct assignment of Custom inspection to the MTLInkstructure objects is not possible.

After custom created Inspection Data file is opened, available inspections are listed in Custom Inspections tab of Single test area of Auto Sequence® Editor, see chapter *E.1 Auto Sequence® Editor workspace* for details.

Custom Inspection is added to Auto sequence as a Single test, see chapter *E.4 Creating / modifying an Auto Sequence®* for details.

Opening / changing Inspection Data File

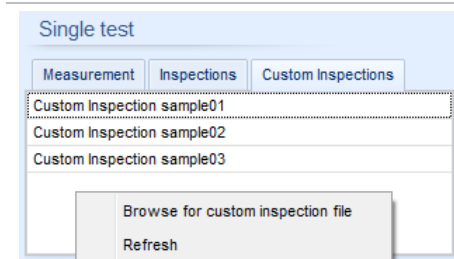

Position cursor within Custom inspections List area and apply mouse right click to open Option menu:

Refresh: Refresh content of already opened Inspection Data file.

Browse for custom Inspection file:

Menu for browsing to folder location of new Inspection Data file is opened.

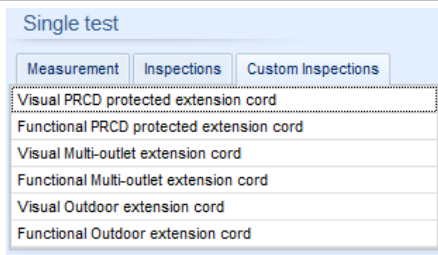

After confirmation of selection, new Inspection Data file is opened and list of available Custom Inspections is changed.

Note:

- › If MTLINKWork scope is changed, opened Inspection Data file remains active and available Custom Inspections remains the same.



FRANCE

Chauvin Arnoux

12-16 rue Sarah Bernhardt

92600 Asnières-sur-Seine

Tél : +33 1 44 85 44 85

Fax : +33 1 46 27 73 89

info@chauvin-arnoux.com

www.chauvin-arnoux.com

INTERNATIONAL

Chauvin Arnoux

Tél : +33 1 44 85 44 38

Fax : +33 1 46 27 95 69

Our international contacts

www.chauvin-arnoux.com/contacts



**CHAUVIN
ARNOUX**