



# Acoustic Imaging Camera

User Manual



Contact Us

## Safety Instruction

These instructions are intended to ensure that user can use the product correctly to avoid danger or property loss.

### Laws and Regulations

- Use of the product must be in strict compliance with the local electrical safety regulations.

### Transportation

- Keep the device in original or similar packaging while transporting it.
- Keep all wrappers after unpacking them for future use. In case of any failure occurred, you need to return the device to the factory with the original wrapper. Transportation without the original wrapper may result in damage on the device and the company shall not take any responsibilities.
- DO NOT drop the product or subject it to physical shock. Keep the device away from magnetic interference.

### Power Supply

- Please purchase the charger by yourself. Input voltage should meet the Limited Power Source (5 VDC, 2 A) according to the IEC61010-1 standard. Please refer to technical specifications for detailed information.
- Make sure the plug is properly connected to the power socket.
- DO NOT connect multiple devices to one power adapter, to avoid over-heating or fire hazards caused by overload.

### Battery

- Improper use or replacement of the battery may result in explosion hazard. Replace with the same or equivalent type only. Dispose of used batteries in conformance with the instructions provided by the battery manufacturer.
- The built-in battery cannot be dismantled. Please contact the manufacture for repair if necessary.
- For long-term storage of the battery, make sure it is fully charged every half year to ensure the battery quality. Otherwise, damage may occur.

- DO NOT charge other battery types with the supplied charger. Confirm there is no flammable material within 2 m of the charger during charging.
- DO NOT place the battery near heating or fire source. Avoid direct sunlight.
- DO NOT swallow the battery to avoid chemical burns.
- DO NOT place the battery in the reach of children.
- The lithium battery voltage is 3.6 V, and the battery capacity is 6230 mAh (22.43 Wh).

### **Maintenance**

- If the product does not work properly, please contact your dealer or the nearest service center. We shall not assume any responsibility for problems caused by unauthorized repair or maintenance.
- A few device components (e.g., electrolytic capacitor) require regular replacement. The average lifespan varies, so periodic checking is recommended. Contact your dealer for details.
- Wipe the device gently with a clean cloth and a small quantity of ethanol, if necessary.
- If the equipment is used in a manner not specified by the manufacturer, the protection provided by the device may be impaired.
- We recommend you send the device back for calibration once a year, and please contact the local dealer for the information on maintenance points.
- Please notice that the current limit of USB 3.0 PowerShare port may vary with the PC brand, which is likely to result in incompatibility issue. Therefore it's advised to use regular USB 3.0 or USB 2.0 port if the USB device fails to be recognized by PC via USB 3.0 PowerShare port.

### **Using Environment**

- Make sure the running environment meets the requirement of the device. The operating temperature shall be -20 °C to 50 °C (-4 °F to 122 °F), and the operating humidity shall be 90% or less.
- DO NOT expose the device to high electromagnetic radiation or dusty environments.
- DO NOT aim the lens at the sun or any other bright light.

### **Technical Support**

The <https://www.hikmicrotech.com/en/contact-us.html> portal will help you as a HIKMICRO customer to get the most out of your HIKMICRO products. The

portal gives you access to our support team, software and documentation, service contacts, etc.

### Emergency

If smoke, odor, or noise arises from the device, immediately turn off the power, unplug the power cable, and contact the service center.



### Manufacture Address

Room 313, Unit B, Building 2, 399 Danfeng Road, Xixing Subdistrict, Binjiang District, Hangzhou, Zhejiang 310052, China

Hangzhou Microimage Software Co., Ltd

## Symbol Conventions

The symbols that may be found in this document are defined as follows.

Symbol	Description
 Danger	Indicates a hazardous situation which, if not avoided, will or could result in death or serious injury.
 Caution	Indicates a potentially hazardous situation which, if not avoided, could result in equipment damage, data loss, performance degradation, or unexpected results.
 Note	Provides additional information to emphasize or supplement important points of the main text.

# Contents

<b>1</b>	<b>Overview .....</b>	<b>1</b>
1.1	Camera Description.....	1
1.2	Main Function.....	1
1.3	Appearance.....	2
1.3.1	Appearance: 64-Microphone Array .....	3
1.3.2	Appearance: 136-Microphone Array.....	4
<b>2</b>	<b>Preparation.....</b>	<b>6</b>
2.1	Mount Hand Strap .....	6
2.2	Operation Method.....	7
2.3	Charge Camera.....	8
2.3.1	Charge Camera via Cable Interface.....	8
2.3.2	Charge Camera via Charging Base .....	9
2.4	Power On/Off.....	10
2.4.1	Set Auto Power-off Countdown .....	11
2.5	Sleep and Wake.....	11
2.6	Auto Microphone Check.....	11
2.7	Live Interface and Menu.....	12
2.7.1	Live View Interface.....	12
2.7.2	Menus.....	14
<b>3</b>	<b>Partial Discharge Detection (PD).....</b>	<b>16</b>
3.1	Partial Discharge Detection Operation.....	16
3.2	PD Types and Levels .....	17
<b>4</b>	<b>Gas Leak Detection (LD) .....</b>	<b>19</b>
4.2	Gas Leak Detection Operations .....	20
4.3	Leak Rate Calibration .....	23
<b>5</b>	<b>Basics of Acoustic Wave Detection .....</b>	<b>25</b>
5.1	Set Frequency .....	25
5.1.1	Switch among Pre-defined Target Frequency Ranges .....	25
5.1.2	Set Target Frequency Range Manually.....	26
5.2	Set Sound Source Distance .....	26
5.3	Set Detection Sensitivity .....	27
5.4	More Tools.....	27
5.4.1	Mark and Display Peak Intensity.....	27
5.4.2	Regional Detection Frame.....	28
5.4.3	Show Multiple Sound Sources .....	28
5.4.4	Ultrasonic to Audible .....	28
<b>6</b>	<b>Display Settings.....</b>	<b>30</b>

# Acoustic Imaging Camera User Manual

---

6.1	Set Acoustic Palettes.....	30
6.1.1	Set Palette Color.....	30
6.1.2	Set Palette Opacity.....	30
6.1.3	Set Intensity Range for Palettes.....	31
6.2	Adjust Digital Zoom.....	31
6.3	Set Grayscale of Visual Image.....	32
6.4	Set Video Standard.....	32
6.5	Set Screen Brightness.....	32
6.6	On-Screen Display Info.....	33
<b>7</b>	<b>Snapshot and Video .....</b>	<b>34</b>
7.1	Capture Snapshot.....	34
7.2	Record Video .....	35
7.3	File Naming Rule.....	36
7.4	View and Manage Local Files.....	36
7.4.1	Manage Albums.....	36
7.4.2	Manage Files.....	37
7.4.3	Edit Files.....	38
7.4.4	Import and Manage Tag Note Templates.....	39
7.5	Export Files.....	40
7.6	Analyze Snapshot via HIKMICRO Analyzer Acoustic.....	41
<b>8</b>	<b>Connections .....</b>	<b>42</b>
8.1	Connect Camera to Wi-Fi.....	42
8.2	Set Camera Hotspot.....	43
8.3	Pair Bluetooth Devices.....	44
8.4	Connect to HIKMICRO Viewer APP.....	44
<b>9</b>	<b>Maintenance.....</b>	<b>46</b>
9.1	View Camera Information.....	46
9.2	Set Language.....	46
9.3	Set Time and Date.....	46
9.4	Upgrade Camera.....	46
9.4.1	Upgrade with HIKMICRO Viewer APP.....	47
9.4.2	Upgrade with an Upgrade File.....	47
9.5	Restore Camera.....	47
9.6	Record Sound Source for Trouble Shooting.....	48
9.7	Save Log.....	48
<b>10</b>	<b>More Information.....</b>	<b>50</b>

# 1 Overview

## 1.1 Camera Description

The HIKMIRCO acoustic imaging camera is a professional product for sound source positioning. With its Low-noise MEMS microphones and adjustable bandwidth range, it provides an easy and effective way to locate the pressurized gas leaks or partial discharge in industrial environments. By using a large 4.3" LCD touch screen, the results overlaying on a visual image allows you to quickly find the source of the problems. Adopting this lightweight and easy-to-use tool, you can discover the potential safety risks, minimize troubleshooting, and save extra costs of equipment failures and downtime.

## 1.2 Main Function

### **Acoustic Imaging**

Camera detects the real-time sound intensity of the sources, and locates the sources in the scene.

### **Partial Discharge Detection (PD)**

Camera detects partial discharge activities and estimate their types based on sound frequency, and displays the real-time estimation in live view for your reference.

### **Gas Leak Detection (LD)**

Camera detects and estimates real-time gas leak rate, leak cost, and leak level for reference.

### **Palette**

Camera supports multiple palettes to display the detected sound sources and their intensities.

### **Record Videos & Capture Snapshots**

Camera supports recording videos, capturing snapshots, and managing albums.

## **1.3 Appearance**

There are two types of the acoustic imaging camera in this series with different microphone array (No.13 in the following figures).



1.3.1 Appearance: 64-Microphone Array

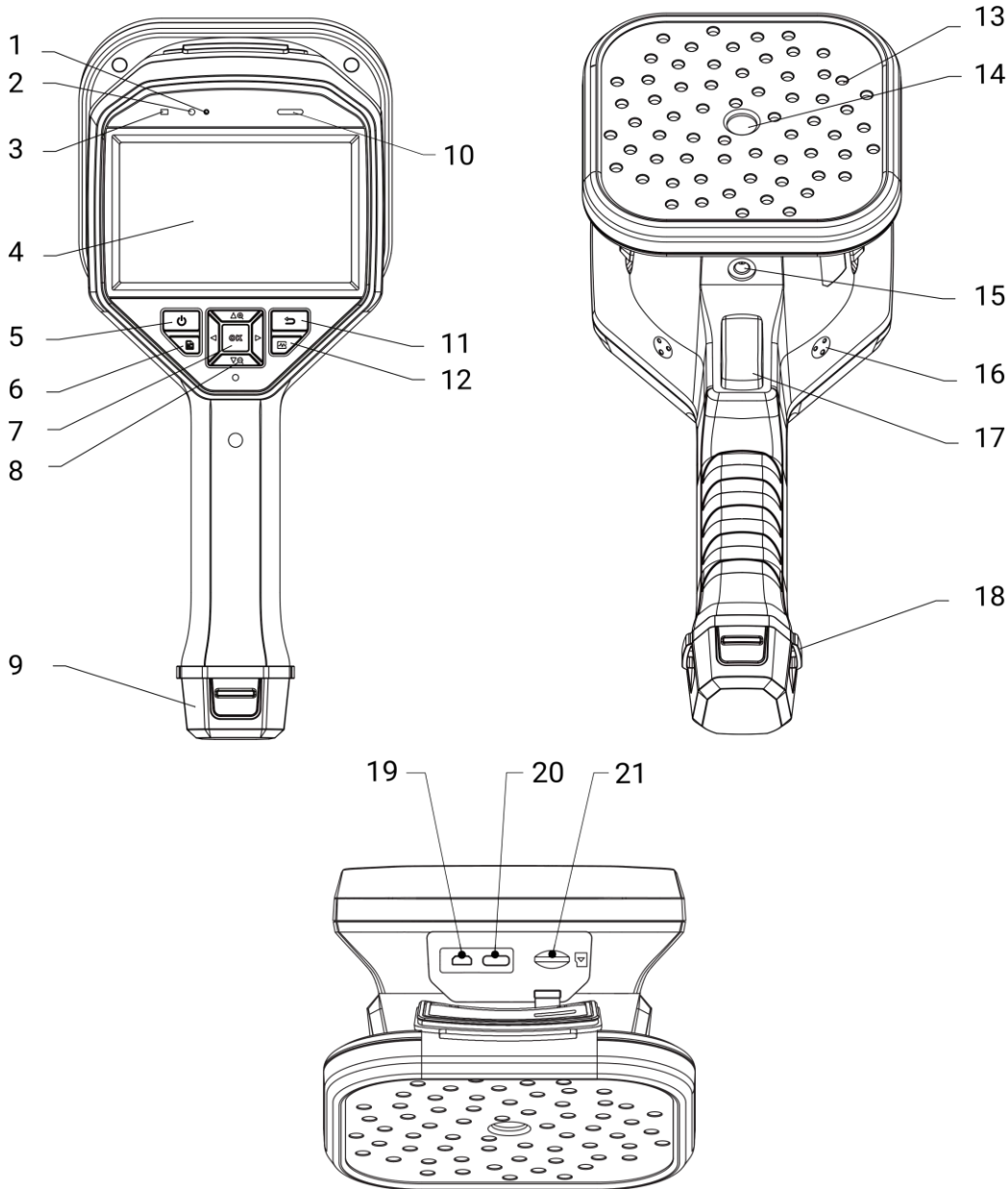

Figure 1-1 Appearance: 64-Microphone Array

1.3.2 Appearance: 136-Microphone Array

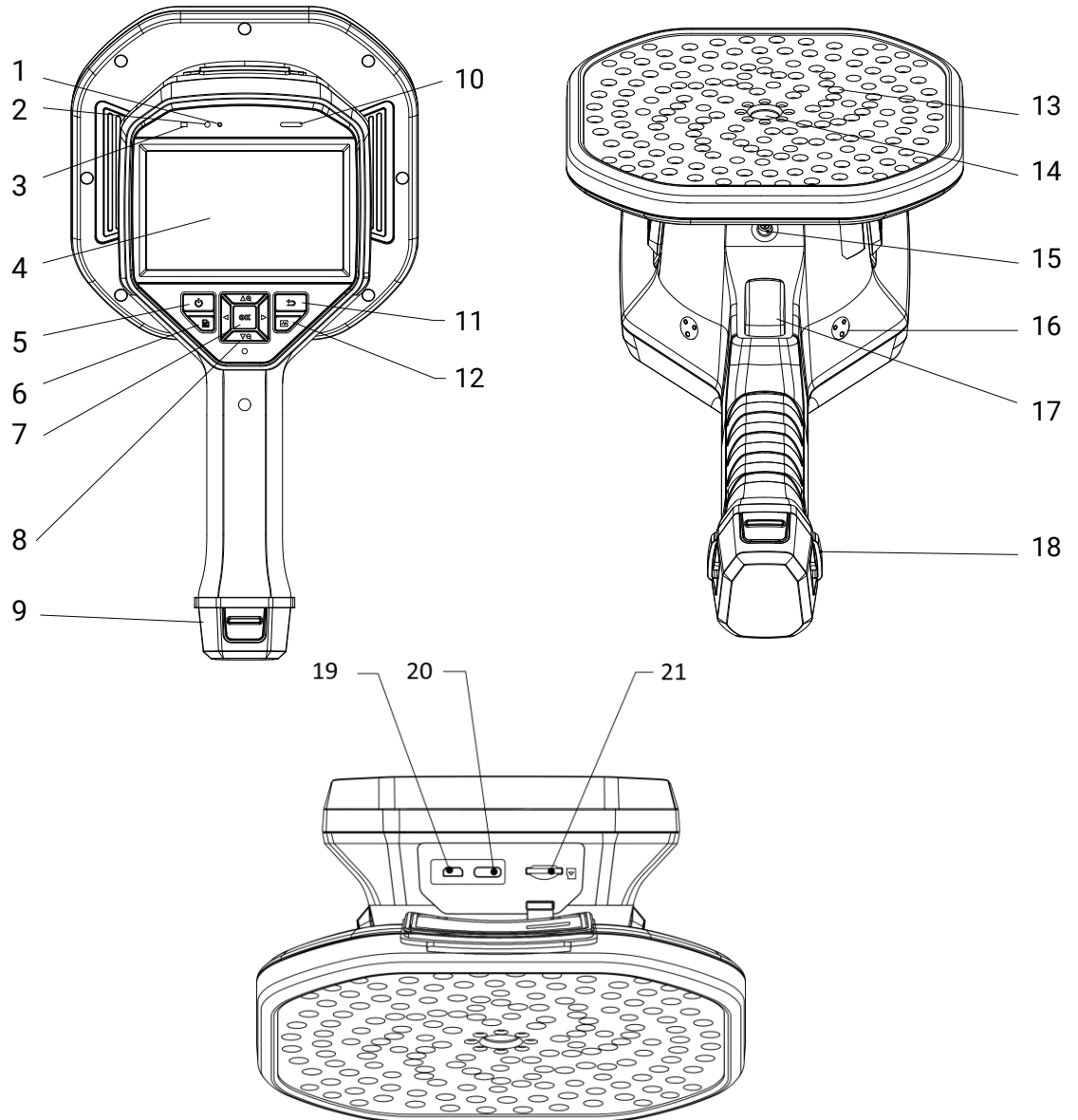















Figure 1-2 Appearance: 136-Microphone Array

Table 1-1 Interface Description

No.	Component	Function
1	Light Sensor	Senses the ambient brightness.
2	Microphone	Records voice notes.
3	Power Indicator	Solid red: Charge normally. Solid green: Fully charged.
4	LCD Touch Screen	Allows live view and touch-screen operation.

## Acoustic Imaging Camera User Manual

---

5	Power Button	Hold  to power on/off. Press  enter/exit sleep mode.
6	File Button	Press  to access the albums.
7	Confirm Button	Non-Menu Mode: Press  to enter menu. Menu Mode: Press  to confirm.
8	Navigation Button	Non-Menu Mode: <ul style="list-style-type: none"> <li>● Press  or  to zoom in or zoom out by 0.1× continuously.</li> <li>● Hold  or  to zoom in or zoom out by 1× continuously.</li> </ul> Menu Mode: Press  ,  ,  , and  to select parameters.
9	Battery Compartment	For holding the battery.
10	Loudspeaker	Plays voice notes.
11	Back Button	Press  to save the parameters and return to previous menu.
12	Frequency Button	Press to select the frequency range frame edges and configure the frequency parameters.
13	Microphone Array	Detects sound in the scene.
14	Visual Camera	Views the visual images.
15	Tripod Attachment Point	Mounts the tripod.
16	Hand Strap Attachment Points	Mounts the hand strap.
17	Trigger	Non-Menu Mode: <ul style="list-style-type: none"> <li>● Press: Capture snapshots.</li> <li>● Hold: Record videos.</li> </ul> Menu Mode: Press to return to live view interface.
18	Hand Strap Attachment Holes	Fixes the lower part of the hand strap to the camera.
19	Micro HDMI Interface	Displays the image and menu interface via HDMI output.
20	Type-C Interface	Charges the camera or exports files with supplied cable.
21	MicroSD Card Slot	For holding the MicroSD card.

## 2 Preparation

### 2.1 Mount Hand Strap

The hand straps aim at attaching to the camera and stabilizing it. Please make sure wrap your hands with the hand straps to prevent the camera from accidental falling or bumping.

The upper part of the hand strap is attached to the camera by a buckle. There are two buckle attachment points on both sides of the camera. The lower part of the hand strap is threaded through the holes at the base of the camera.

1. Insert the upper part of the hand straps into the buckles.

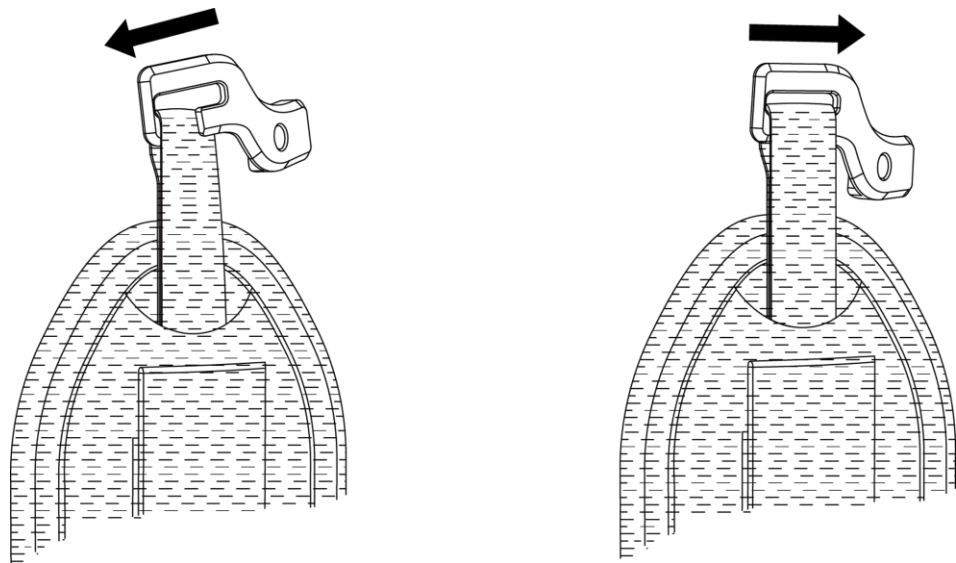

Figure 2-1 Insert Upper Part of Hand Strap

2. Fit the buckle on the camera and tighten the screw with the supplied wrench.
3. Thread the lower part of the hand strap through the hole at the base of the camera.
4. Secure the hand strap with the hook-and-loop fastener. Adjust the tightness according to your hands.

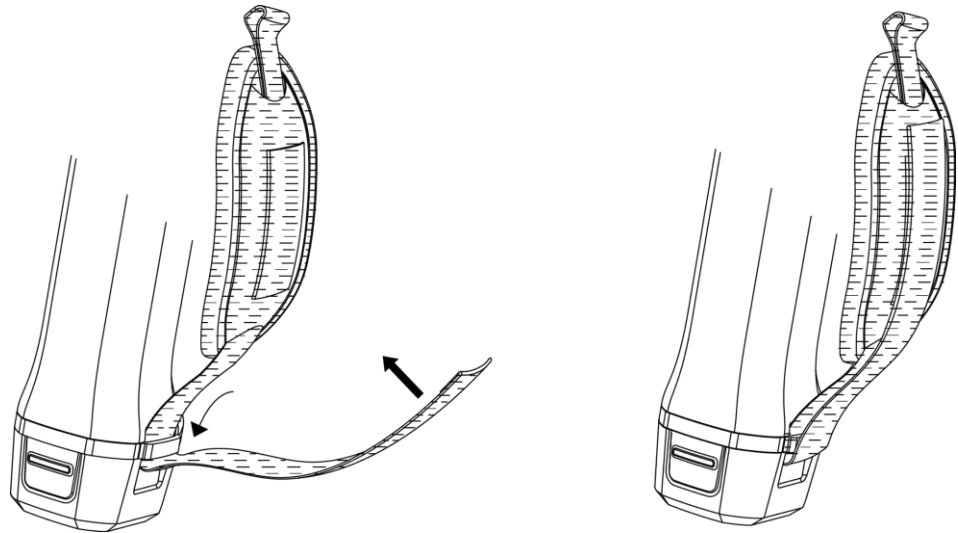

Figure 2-2 Secure Lower Part of Hand Strap

## 2.2 Operation Method

The camera supports both touch-screen control and button control.

### Touch-Screen Control

Tap on the screen to set parameters and configurations.

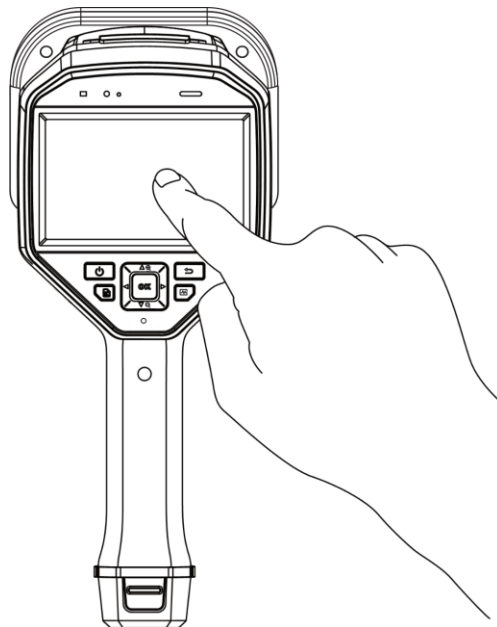

Figure 2-3 Touch-Screen Control

## Button Control

Press the navigation buttons to set parameters and configurations.

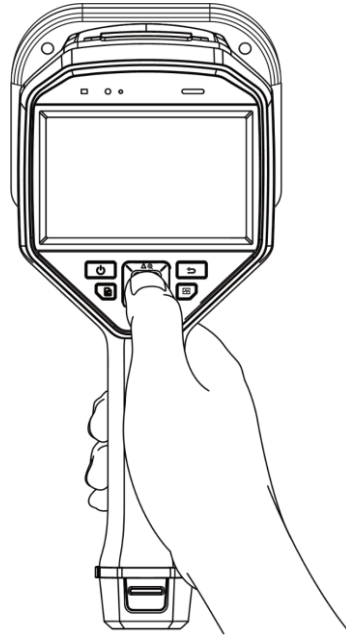

Figure 2-4 Button Control

## 2.3 Charge Camera

Please fully charge the camera before it is used for the first time or when it is in low battery.

### 2.3.1 Charge Camera via Cable Interface

#### *Before You Start*

Please make sure the battery is installed before charging via cables.

#### *Steps*

1. Open the connector cover of the camera.
2. Plug the type-C male connector of the charging cable to the camera and the other type-A connector to power adapter.

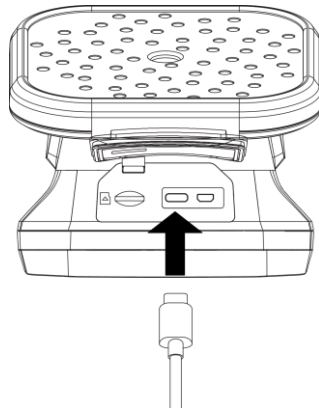

Figure 2-5 Charge via Type-C Cable

### 2.3.2 Charge Camera via Charging Base

You can take out the battery and insert it into the charging base for fast charging.

#### *Before You Start*

Please make sure the camera is power off before removing the battery.

#### *Steps*

1. Hold the camera, and press both battery lock catches of the camera.

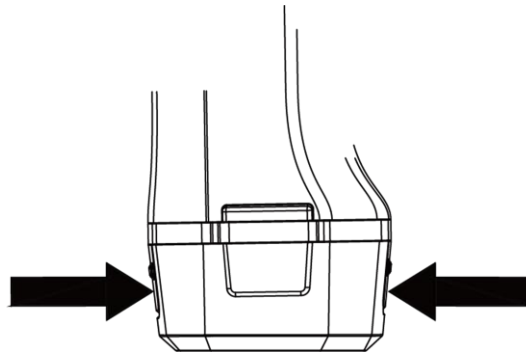

Figure 2-6 Remove Battery Base

2. Hold the lock catches, and draw the battery base to take out the battery.
3. Insert the battery into the charging base. You can see the charging status via the pilot lamp on the charging base.



The red indicating light is on if the battery is charging properly, and the green indicating light is on if the battery is fully charged.

---

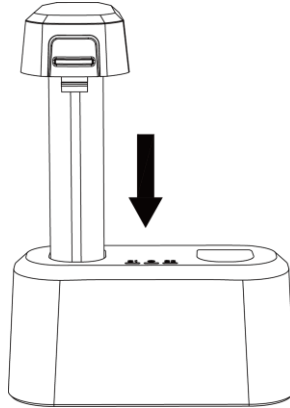



Figure 2-7 Charge Battery

4. When the battery is fully charged, draw the battery from the charging base.
5. Insert the battery into the camera and push it into the locked position.

## 2.4 Power On/Off

### Power On

Hold  to turn on the camera. You can observe the target when the live view interface is stable.



If the battery of the camera is low, please charge it in time or replace it with a fully-charged standard battery, so as to ensure that the camera functions normally.

---



### Power Off

When the camera is turned on, hold  to power off the camera.



## 2.4.1 Set Auto Power-off Countdown

### *Steps*

1. Press  in the live view interface to show the menu.
2. Go to **Settings > Device Settings > Auto Off**.
3. Tap Auto Off or press  to enable auto power-off.
4. Set the automatic shutdown time for camera as required.
5. Press  to save and return to previous menu.

## 2.5 Sleep and Wake

Sleep and wake is used to save energy and increase battery time.

### **Sleep and Wake Manually**

Press  to enter sleep mode and press again to wake camera up.

### **Set Auto Sleep**

In live view, press  to call the main menu. Go to **Settings > Device Settings > Auto Sleep** to set waiting time before auto sleep.

When there is no button pressing or screen tapping operation on camera for more than the set waiting time, camera enters sleep mode automatically.

### **Camera Sleep, Scheduled Capture and Video Recording**

When the camera is recording a video clip or on scheduled capturing, auto sleep will not be triggered. However, press  will stop the video recording or scheduled capture and force the camera into sleep mode.

## 2.6 Auto Microphone Check

Auto microphone check is a camera self-test on the microphone array.

Go to **Settings > Device Settings > Auto Microphone Check** for the test. If microphone error is detected, please contact your dealer or our technical support for help.

## 2.7 Live Interface and Menu

### 2.7.1 Live View Interface

After starting up, camera screen shows the live view interface with detected acoustic wave.

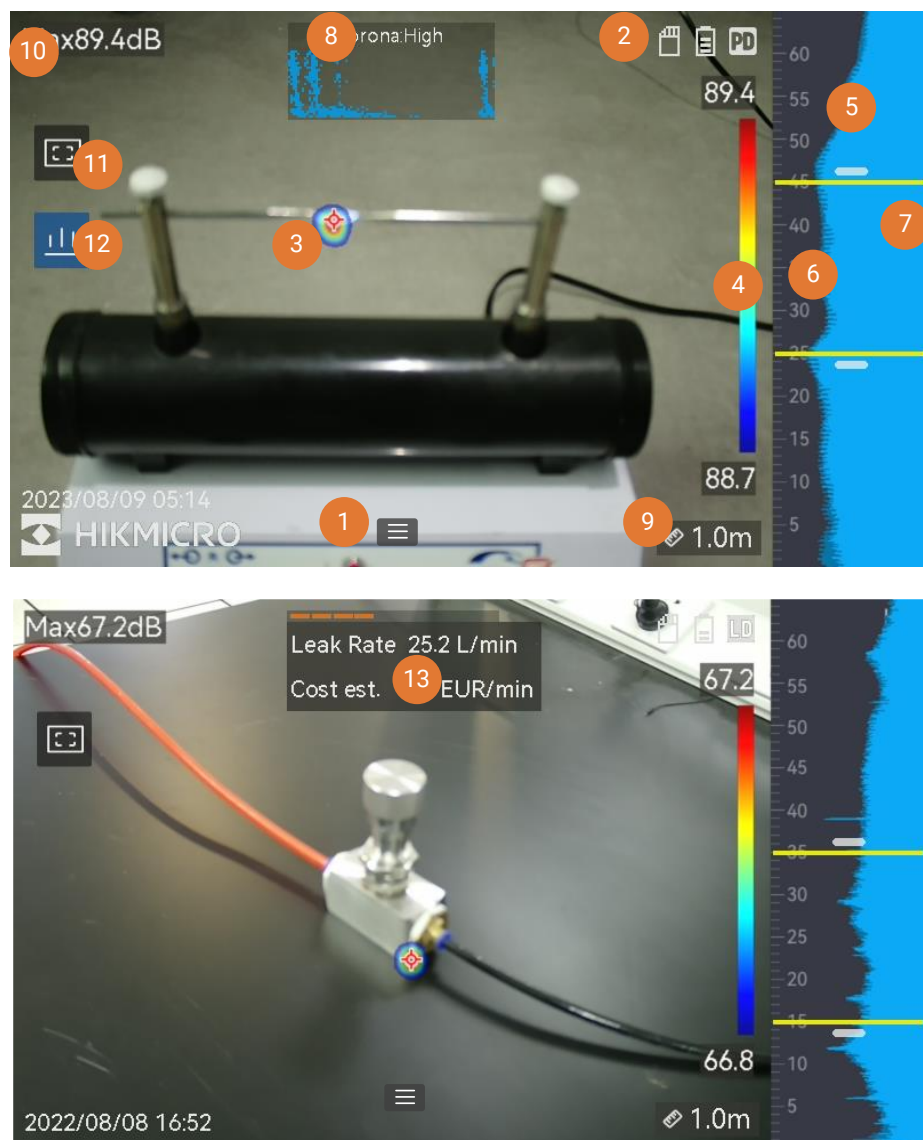



Figure 2-8 Live View Interface

Table 2-1 Live View Interface Description

No.	Part Name	Function
1	Menu Icon	Tap on the icon to call the main menu.
2	Status Bar	Camera working status icons are displayed in the bar. You can turn on/off the display from <b>Settings &gt; Display Settings &gt; Status Icons</b> .
3	Acoustic Palette	The location and intensity of detected sound source are converted to palette colors overlaying on the visual image for easy observation. The size of palette stands for the intensity of the sound source. Bigger acoustic palette covered area means wider sound intensity range.
4	Intensity Scale (Palette Bar)	Intensity scale (palette bar) show the relation between displayed color and sound intensity. The value at the ends of the bar stands for the maximum and minimum intensity of the set frequency range. <i>See 6.1.1 Set Palette Color for setting instructions.</i>
5	Frequency Band	Shows the supported frequency band of the camera.
6	Selected Frequency Band / Target Frequency Range	Sound intensity of this frequency band is detected and converted to acoustic palette. <i>See 5.1 Set Frequency for instructions.</i>
7	Dynamic Intensity of All Frequencies	Shows the intensity change of supported frequencies.
8 & 12	PRPD and its Control Icon	Only available in PD mode. Tap on icon (12) to display phase resolved partial discharge (PRPD) diagram for better PD activity diagnosis. Tap on PRPD diagram (8) to enlarge the display.
9	Sound Source Distance	Shows the set distance of sound source. <i>See 5.2 Set Sound Source Distance for setting instructions.</i>

No.	Part Name	Function
10	Maximum Intensity	Stands for the detected maximum intensity of the scene. See 5.4.1 <i>Mark and Display Peak Intensity</i> for setting instructions.
11	Regional Detection Frame	Tap on the icon to show a frame in the middle of the screen. The camera only displays sound sources in the frame to reduce interference from less interested areas. See 5.4.2 <i>Regional Detection Frame</i> for more information.
13	Gas Leak Info.	Only available in LD mode. Shows detected gas leak estimation. See 4 <i>Gas Leak Detection (LD)</i> for more information.

## 2.7.2 Menus

In the live view interface, tap  or press  to show the menu bar, and swipe down to call the swipe-down menu.

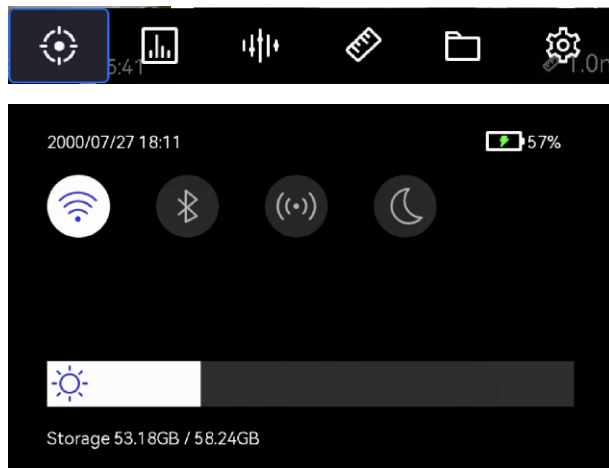













Figure 2-9 Main Menu and Swipe-Down Menu

Table 2-2 Menu Description

Menu Icon	Function
	Detection mode switch. Partial Discharge Detection (PD) and Gas Leak Detection (LD) are supported.
	Adjusts detection sensitivity. Bigger value means higher sensitivity. See 5.3 <i>Set Detection Sensitivity</i> for setting instructions.
	Pre-defined target frequency ranges for quick switching.



Menu Icon	Function
	Distance to sound source.
	Local albums of captured images and videos. See <i>7.4 View and Manage Local Files</i> for setting instructions.
	Settings of all camera function.
	Tap to turn on/off camera Wi-Fi. See <i>8.1 Connect Camera to Wi-Fi</i> for setting instructions.
	Tap to turn on/off camera Bluetooth. See <i>8.3 Pair Bluetooth</i> for setting instructions.
	Tap to turn on/off camera hotspot. See <i>8.2 Set Camera Hotspot</i> for setting instructions.
	Tap to switch menu themes between dark and light.
	Swipe to adjust screen brightness.

## 3 Partial Discharge Detection (PD)

Partial discharge detection is often used in electrical equipment and facility inspection. It detects abnormal partial discharges faults and instructs maintenance activities.

### 3.1 Partial Discharge Detection Operation

#### *Steps*

1. In the live view interface, tap  or press  to show the menu.
2. Select  to switch detection mode to PD.
3. Set detection distance. Measure the distance between the microphone array to the target and input the data to the camera. *See 5.2 Set Sound Source Distance.*
4. Hold and aim the microphone array to the target.
5. (Optional) If the target sound source is small and there is much interference around, enable the regional detection frame. *See 5.4.2 Regional Detection Frame.*
6. (Optional) If you want to listen to the detected ultrasonic sound source (usually inaudible with human ears) for double confirm, enable Ultrasonic to Audible and connect your camera to a pair of Bluetooth headsets. *See 5.4.4 Ultrasonic to Audible and 8.3 Pair Bluetooth .*
7. Adjust the selected frequency range. *See 5.1 Set Frequency.*
8. Adjust detection sensitivity. *See 5.3 Set Detection Sensitivity.*
9. Check acoustic palettes position, maximum sound intensity position, PRPD diagram and the detection result on screen. To read the result, *see 3.2 PD Types and Levels.*
10. Take snapshots or record videos of the suspected sound sources. *See 7 Snapshot and Video.*

### 3.2 PD Types and Levels

When detecting a partial discharge sound source, camera automatically identifies the type and strength level, and display the result on screen.



Due to potential environmental factors that may affect detection accuracy, PD type and strength level provided are approximate and for informational purposes only.

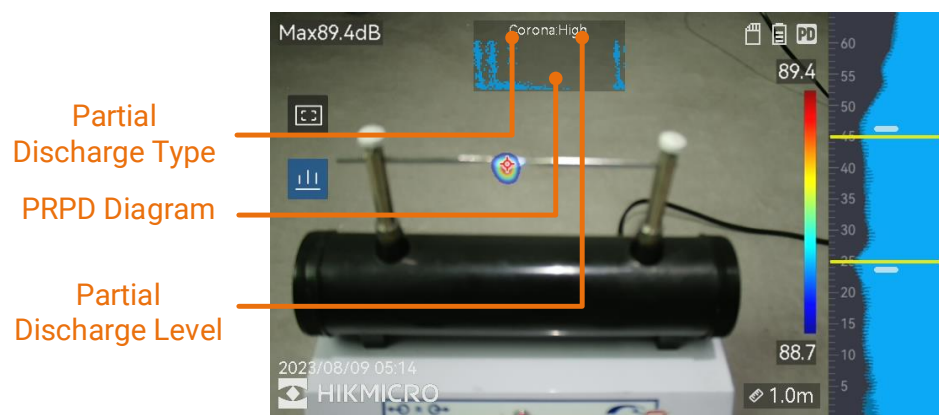

Figure 3-1 Partial Discharge Display

The explanation of screen display and the recommended handling are shown in the following tables.

Table 3-1 Partial Discharge Types

Partial Discharge Types	Explanation
Corona	Corona discharge occurs on the sharp surface of a conductor surrounded by gas. It usually happens in electrical systems like high-voltage power lines, transformers, or electrical motors.
Floating	Floating discharge, one of arcing discharges, happens when the electrical current flows through the conducting path created by voltage difference between two conductors. It might occur in various situations, such as high-voltage power transmission systems, electrical switches, circuit breakers, and welding equipment.

Partial Discharge Types	Explanation
Surface	Surface discharge refers to the electrical discharge travels along the surface of insulation. It is primarily caused by the contamination and weather conditions like high humidity, of the insulator surface. It often occurs in high-voltage equipment, such as transformers, cables, switchgear, and motors.
Particle	Particle discharge refers to the partial discharge of electrical energy that interacts with metallic particles and debris present in the electrical systems. It can result from loose particles or particles generated by mechanical wear, corrosion, or degradation of insulation materials.
Noise	Other detected sound.

If different types of partial discharges coexist in the scene, the most prominent partial discharge type shows in live view.

Table 3-2 Partial Discharge Severity and Handling

Partial Discharge Severity	Recommended Handling
Normal	No observable/measurable deterioration.
Low	Minor deterioration which requires attention. Shorten inspection period and take maintenance actions when necessary.
Medium	Moderate deterioration. Locate and clean the Item during routine maintenance, or carry out related electrical test of the item. Or use online monitor to monitor the discharge tendency.
High	Serious deterioration. Item cannot be returned to service without shut down or engineering advise.



## 4 Gas Leak Detection (LD)

LD mode is often used in gas leak detection of gas pipelines, tanks, valves, etc.

In LD, there are 2 gas leak modes with different calculations of leak cost. Select the leak mode according to the inspected target and the way of cost calculation.

Table 4-1 Gas Leak Modes

Gas Leak Mode	Description
Bottled Gas	Locate leak points and detect leak rate. Calculate estimated cost according to the price of gas and leak rate.
Compressed Air	Locate leak points and detect leak rate. The leak cost is the cost of extra power that the air compressor consumed to maintain system pressure. The cost is calculated according to detected leak rate, price of electricity, air compressor specific power and its everyday working hours. The power waste can also be converted to CO2 emissions for display.



This product is designed to assess gas leak to achieve cost savings. However, due to potential environmental factors that may affect detection accuracy, the estimations provided are approximate and for informational purposes only. It should be noted that the results presented by the camera are not a guarantee of actual cost savings or a recommendation, and may not accurately reflect the specific situation of your facilities.

---

## 4.2 Gas Leak Detection Operations



The following procedure is a general operation guide. Fine tune the detection by adjusting leak type, frequency, distance, and sensitivity to find solid and stable leak points.

### Steps

1. In the live view interface, tap or press to show the menu.
2. Select to switch detection mode to LD.
3. Go to **Settings > Acoustic Settings > Gas Leak Settings > Gas Leak Mode**, and set the mode as **Bottled Gas** or **Compressed Air**. See Table 4-1 for mode difference.
4. Set leak detection parameters.



The parameters affect detection accuracy, please set them correctly.

Table 4-2 Detection Parameters Settings

Parameter	Description	Setting Path
Leak Type	Set according target type, metal pipes, threaded pipe, quick pipe joint, and other are selectable. Different target type calls different algorithms to improve accuracy.	Settings > Acoustic Settings > Gas Leak Settings > Leakage Type
System Pressure	The pressure of inspected container or pipes. The paramter helps improve accuracy when detecting small leaks. Pressure unit can be changed from Settings > Acoustic Settings > Gas Leak Settings > Unit Settings > Pressure.	Settings > Acoustic Settings > Gas Leak Settings > System Pressure

5. Set the parameters for result display and cost calculation.

Refer to Table 4-3 for the parameters for compressed air leak, and Table 4-4 for bottled gas leak.

Table 4-3 Compressed Air Leak: Result Display and Cost Calculation

Parameter	Description	Setting Path
Leak Rate Unit	Unit for leak rate display.	Settings > Acoustic Settings > Gas Leak Settings > Unit Settings > Leak Rate Unit
Leak Level	Set leak rate for different leak levels indicating different severity. Use ⊕ and ⊖ to add or cancel a level. Leak level is displayed above the leak rate in the result window.	Settings > Acoustic Settings > Gas Leak Settings > Leak Level
Air Compressor Specific Power	Air compressor specific power, indicating the working efficiency of an air compressor, is the ratio of input power to compressed air flow rate at a given pressure. It can be found in the data sheet of the air compressor.	Settings > Acoustic Settings > Gas Leak Settings > Compressed Air Settings > Air Compressor Specific Power
Price of Electricity	The electricity price of the inspected plant/facility.	Settings > Acoustic Settings > Gas Leak Settings > Compressed Air Settings > Price of Electricity
Leak Cost Time Unit	Time period for cost calculation.	Settings > Acoustic Settings > Gas Leak Settings > Unit Settings > Leak Cost Time Unit
Operating Hours per Day	Working hours of the air compressor per day. It affects the estimated cost display.	Settings > Acoustic Settings > Gas Leak Settings > Compressed Air Settings > Operating Hours per Day

Parameter	Description	Setting Path
CO2 Emissions per kWh	CO2 emissions per kWh (carbon emissions from electricity) are determined by the type of energy source used for power generation and are affected by factors such as the efficiency of the power generation equipment. It can be obtained by querying the carbon emission factor of the local power grid.	Settings > Acoustic Settings > Gas Leak Settings > Compressed Air Settings > CO2 Emissions per kWh

Table 4-4 Bottled Gas Leak: Result Display and Cost Calculation

Parameter	Description	Setting Path
Leak Rate Unit	Unit for leak rate display.	Settings > Acoustic Settings > Gas Leak Settings > Unit Settings > Leak Rate Unit
Leak Level	Set leak rate for different leak levels indicating different severity. Use ⊕ and ⊖ to add or cancel a level. Leak level is displayed above the leak rate in the result window.	Settings > Acoustic Settings > Gas Leak Settings > Leak Level
Price of Gas	Price of leaking gas.	Settings > Acoustic Settings > Gas Leak Settings > Bottle Gas Settings > Price of Gas
Leak Cost Time Unit	Time period for cost calculation.	Settings > Acoustic Settings > Gas Leak Settings > Unit Settings > Leak Cost Time Unit

6. Set detection distance. Measure the distance between the microphone array to the target and input the data to the camera. *See 5.2 Set Sound Source Distance.*

7. Hold and aim the microphone array to the target.
8. (Optional) If the target sound source is small and there is much interference around, enable the regional detection frame. See 5.4.2 *Regional Detection Frame*.
9. (Optional) If you want to listen to the detected ultrasonic sound source (usually inaudible with human ears) for double confirm, enable Ultrasonic to Audible and connect your camera to a pair of Bluetooth headsets. See 5.4.4 *Ultrasonic to Audible* and 8.3 *Pair Bluetooth*.
10. Adjust the selected frequency range. See 5.1 *Set Frequency*.
11. Adjust detection sensitivity. See 5.3 *Set Detection Sensitivity*.
12. Check acoustic palettes position, maximum sound intensity position, and the detection result on screen.

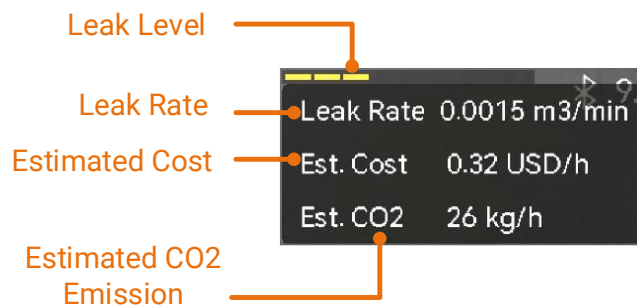

Figure 4-2 Gas Leak Estimation (Compressed Air)



13. (Optional) Calibrate the leak rate if you find it is deviated from the actual amount. See 4.3 *Leak Rate Calibration*.
14. Take snapshots or record videos for the suspected sound sources. See 7 *Snapshot and Video*.

### 4.3 Leak Rate Calibration

If you find the leak rate is deviated from the actual amount, set a calibration factor for each leak rate range. Calibrated leak rate = the detected leak rate × the set calibration factor.

You can set different calibration factors for different leak rate ranges. Calibration factor is a number from 0.000000 to 10.000000, up to 6 decimal places allowed.

#### *Steps*

1. In the live view interface, tap  or press  to show the menu.
2. Select  to switch detection mode to LD.
3. Go to **Settings > Acoustic Settings > Gas Leak Settings > Leak Rate Calibration**, and enable the function.
4. Select a range to calibrate, and input a factor number by the soft keyboard for the range.



Leak rate ranges are camera provided, set a calibration factor for each range in use.

---

5. Press  to confirm the settings and set factors for other ranges.

## 5 Basics of Acoustic Wave Detection

The camera supports acoustic wave detection among different frequency ranges. Detected sound source is marked with shaped acoustic palettes to show its dynamic location and intensity.

### 5.1 Set Frequency

#### *Steps*

1. The camera supports sound detection of two configurable frequency bands with different upper limit. Choose the one that better covers possible target frequencies from **Settings > Acoustic Settings > Frequency Band**.
2. Select a target frequency band, sound of which is visualized to acoustic palettes in the display for easy observation. You can switch among 3 pre-defined frequency ranges or adjust manually.

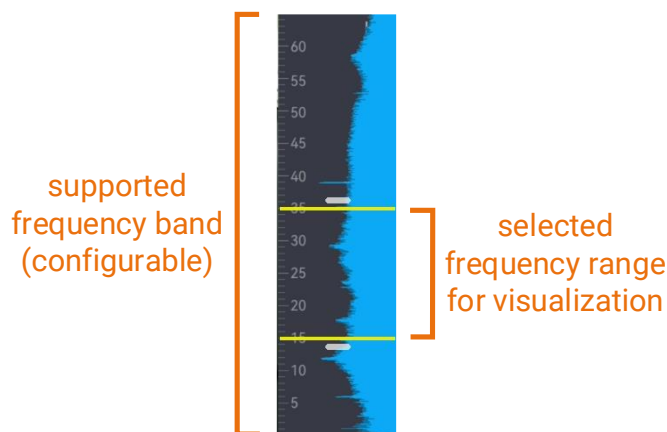



Figure 5-1 Frequency

#### 5.1.1 Switch among Pre-defined Target Frequency Ranges

##### *Steps*

1. In the live view interface, tap  or press  to show the menu.





2. Select  and select a range option.

## 5.1.2 Set Target Frequency Range Manually

### Steps

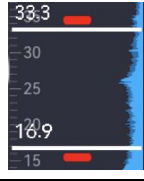
1. Select a subject for adjustment.

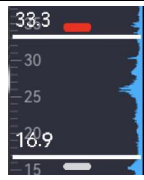
Table 5-1 Selected Frequency Adjustment

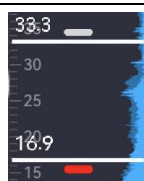
Objective	Operation	Operation Result
Adjust the upper and lower limits together.	Press  once or tap the area between the yellow lines.	
Adjust the upper limit only.	Press  twice or tap on the upper yellow line.	
Adjust the lower limit only.	Press  three times or tap on the lower yellow line.	









2. Press/hold  and  to adjust values.

3. Press  to save and exit.

## 5.2 Set Sound Source Distance

Distance to sound source helps to increase the acoustic wave detection accuracy.

### Steps







1. In live view interface, tap  or press  to show the menu.
2. Select .
3. Adjust the distance value by pressing/holding  and  or tapping  and .
4. Press  to save and exit.



## 5.3 Set Detection Sensitivity

Higher sensitivity means that sound source of lower intensity can be detected. Higher sensitivity also means that interferences are more easily to be detected and displayed.

### Steps

1. In the live view interface, tap  or press  to show the menu.
2. Select .
3. Press  and  or tapping on screen to select a level. Bigger number means higher sensitivity.
4. Press  to save and exit.

## 5.4 More Tools

### 5.4.1 Mark and Display Peak Intensity

Mark peak intensity point with  and display the peak intensity value on screen.

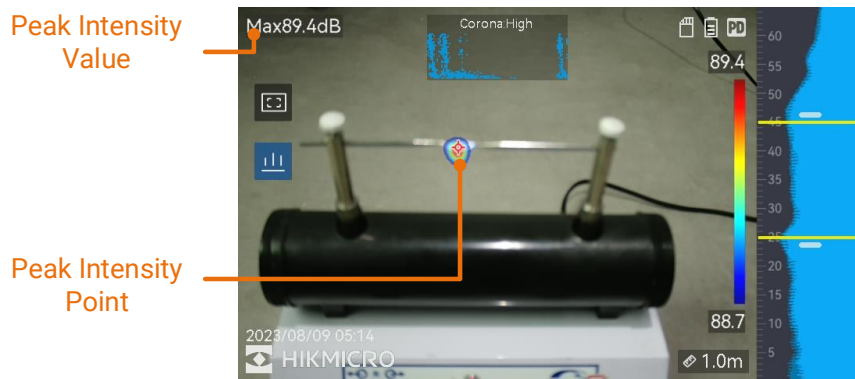





Figure 5-2 Mark Peak Intensity

### Steps

1. In live view interface, tap  or press  to show the menu.
2. Go to Settings > Acoustic Settings > Sound Intensity Display.
3. Enable **Peak**.
4. Press  to save and exit.

### 5.4.2 Regional Detection Frame

If the target sound source is small and there is sound interference around, enable the regional detection frame and aim the frame to the target. Sound detection only carries out in the framed area.

Tap  to turn on/off regional detection frame.

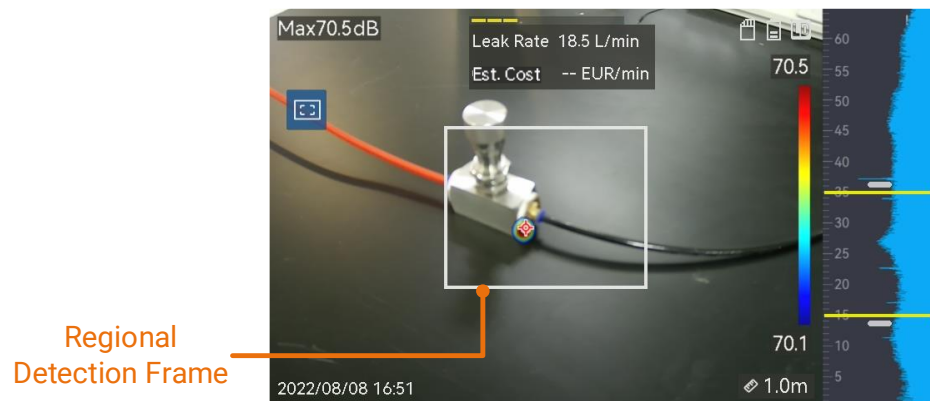

Figure 5-3 Regional Detection Frame

### 5.4.3 Show Multiple Sound Sources

Usually, camera only displays acoustic palettes at the strongest sound source. If you want to see the other sound sources in the scene, turn on **Multiple Sources** from **Settings > Acoustic Settings > Multiple Sources**.



In practice, multiple sound source mode is hard to avoid the influence of reflected sound sources. In cases that pipes for inspection are close to ceiling or wall, detected multiple sources are likely several reflections of one leak point. Thus, we are not recommended to use the mode in scenarios with strong reflection.

---

### 5.4.4 Ultrasonic to Audible

Normally, human ear can hear sound with its frequency ranges from about 20 to 20,000 Hz. Sound of higher frequency should be converted to audible sound for hearing.

Camera supports Ultrasonic to Audible function for the conversion. Connect the camera to Bluetooth headphones for listening to real-time ultrasonic sound sources.



- Users should prepare a pair of Bluetooth headphones.
  - After enabling the Ultrasonic to Audible, ultrasonic sound in recorded videos is also converted.
  - Converted sound source can not be played with the camera speaker.
  - Ultrasonic to Audible function is paused when other audio files (voice note and audio in video clips) are played.
- 

### Steps



1. Connect your camera to a pair of Bluetooth headsets. See *8.3 Pair Bluetooth*.
2. Enable **Ultrasonic to Audible** function.
  - 1) In live view interface, tap  or press  to show the menu.
  - 2) Go to **Settings > Acoustic Settings > Ultrasonic to Audible**.
  - 3) Enable the function and an ear icon shows in the live image.
3. Listen to the real-time audio and adjust volume.
  - 1) Tap on the  on the screen.
  - 2) Slide the volume bar for adjustment.



Figure 5-4 Ultrasonic to Audible and Volume Adjustment



## 6 Display Settings

### 6.1 Set Acoustic Palettes

Acoustic palettes are the shaped colors overlaying on visual image indicating the location and strength of detected sound source. Palette color, opacity and intensity range of palettes are adjustable.

#### 6.1.1 Set Palette Color

##### *Steps*

1. Press  in the live view interface to show the menu.
2. Select  from the main menu, go to **Acoustic Settings > Palettes**, and select a desired color combination.
3. Press  to save and exit.



##### *Result*

Acoustic palette overlaid above the sound source and palette bar changes to the selected palette.

#### 6.1.2 Set Palette Opacity

You can view the acoustic palette and the visual images at the same time if the opacity is properly set.

##### *Steps*

1. In live view interface, tap  or press  to show the menu.
2. Go to **Settings > Acoustic Settings > Palettes Opacity**, and select a desired level.
3. Press  to save and exit.



The opacity level ranges from 0% to 100%. The lower the value is, the more transparent the acoustic palette is.

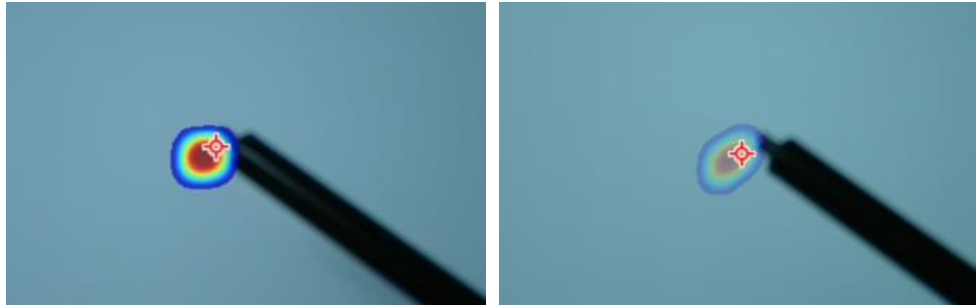

Level: 75% vs Level: 25%

---

## 6.1.3 Set Intensity Range for Palettes

Colors in palettes stand for different sound intensity values. Usually, camera automatically calculates intensity range for palettes. You can also manually set a fixed range if the auto palette display is not satisfactory.

- **Auto (default):** Camera calculates the upper limit, lower limit, and the intensity delta automatically.
- **Manual:** Camera calculates the upper limit and lower limit of intensity according to the set intensity delta and actual intensity of target sound source.

### *Steps*

1. In the live view interface, tap or press to show the menu.
2. Go to **Settings > Acoustic Settings > Intensity Range**, and press to switch to Manual.
3. Select **Intensity Delta** and press .
4. Press/hold and to adjust values.
5. Press to save and exit.

## 6.2 Adjust Digital Zoom

The camera supports 1× to 16× digital zoom.



- In the live view interface, hold or to zoom in or zoom out by 1× continuously.

- In the live view interface, press  $\triangle\oplus$  or  $\nabla\ominus$  to zoom in or zoom out by 0.1× precisely.

## 6.3 Set Grayscale of Visual Image

The colored live view image turns to black and white if grayscale image is enabled. The black and white image makes colored acoustic palettes more prominent for observation.

### *Steps*

1. In the live view interface, tap  or press  $\textcircled{K}$  to show the menu.
2. Go to **Settings > Display Settings**.
3. Enable **Grayscale Image**.
4. Press  to save and exit.

## 6.4 Set Video Standard

Video standard refers to the standard used in the visual camera. Set it according to the mains frequency in your country/region. PAL and NTSC are selectable.





Striped image may occur if wrong video standard is in use.

---

Go to **Settings > Device Settings > Video Standard** to switch standards. It takes effect after camera restart.

## 6.5 Set Screen Brightness

### *Steps*

1. In the live view interface, tap  or press  $\textcircled{K}$  to show the menu.
2. Select  from the main menu, go to **Device Settings > Screen Brightness**.

- Auto: The camera adjusts screen brightness automatically according to the ambient brightness.
- Manually: Drag the brightness adjustment slider to the left or right to manually adjust screen brightness.



You can also manually adjust brightness from swipe-down menu.

---







Figure 6-1 Brightness Adjustment Slider

## 6.6 On-Screen Display Info.

On-Screen Display (OSD) information informs you the status, time and date, and other information of the camera in the live view interface.

### *Steps*

1. In the live view interface, tap  or press  to show the menu.
2. Go to **Settings > Display Settings**.
3. Tap  or press  to select the on-screen information.
4. Press  to save and exit.

## 7 Snapshot and Video

Take snapshots or record videos of inspections or suspected targets for further analysis or other purposes. Snapshots and videos saved in the camera can be exported to PC via USB cable.



- Camera does not support capturing or recording when the menu is shown.
  - When the camera is connected to your PC, it does not support capturing or recording.
  - Go to **Settings > Device Settings > Device Initialization** to initialize the memory card if needed.
- 

### 7.1 Capture Snapshot

Operate the camera to capture live images and save the snapshots in local albums.

#### *Before You Start*

Make sure that there is a working memory card mounted in your camera. See *1.3 Appearance* to locate the memory card slot of your camera.

#### *Steps*

1. Set a capture mode and pull **Trigger** in live view interface to capture snapshots. There are 3 modes available. Each mode requires different operations.
  - 1) Go to **Settings > Capture Settings > Capture Mode**.
  - 2) Select a mode.
    - **Capture One Image**: Pull **Trigger** once to capture one snapshot.
    - **Scheduled Capture**: Set the capture **Interval** and **Number**. Pull **Trigger** in live view, and the camera captures snapshots according



to the set interval and amount. Pull **Trigger** again or press  to stop capturing.

- 3) Press  to return to the live view interface.
- 4) Aim the lens to your target and pull **Trigger** to capture snapshots.

2. **Optional:** After capturing, you can tap the thumbnail of the captured snapshot to view and edit the image.

### ***What to do next***

- Go to albums to view and manage files and album folders. See *7.4.1 Manage Albums* and *7.4.2 Manage Files* for operation instructions.
- To edit saved images, see *7.4.3 Edit Files* for operation instructions.
- You can connect your camera to PC to export local files for further use. See *7.5 Export Files*.



## 7.2 Record Video

You can record videos of the target. The recorded video and audio are saved in the memory card.

### ***Steps***

1. In the live view interface, hold the trigger to start recording. The recording status icon and time icon appear.
2. When you finish, pull the trigger again to stop recording. The recorded video will be saved automatically and exit.



You can also press  or  to stop recording.

---

3. Refer to *7.5 Export Files* to export videos.



The video format is MP4 format. You can play videos on the camera or export to the compatible players to play.

---

## 7.3 File Naming Rule

Naming rule of captured pictures and videos is allowed to change. Go to **Settings > Capture Settings** to set **Filename Header** and **File Naming**.



Table 7-1 File Naming Rule

Element	Description
Filename Header	File name starts with the set header.
File Naming	Time Stamp or Numbering are selectable. Time stamp includes year, month, day, hour, minute, and second.

## 7.4 View and Manage Local Files

Camera captured snapshots and videos are saved in local albums. You can create, delete, rename and set an album as the default saving album. For files, operations, such as browsing, moving and deleting, are available.









### *Steps*

1. Enter album.
  - In live view, press  to enter albums.
  - In live view, press  to call the main menu, and select  to enter albums.
2. To create, rename, delete and set an album as the default saving album, see *7.4.1 Manage Albums* for instructions.
3. For file operations, such as, moving or deleting a file, see *7.4.2 Manage Files* for instructions.
4. To modify an image, for example, editing the text or voice notes saved with the images, see *7.4.3 Edit Files* for instructions.

### 7.4.1 Manage Albums

You can create several albums to manage captured snapshots and video files on your camera. Newly captured snapshots and videos are saved in the **Default Saving Album** .

### *Steps*

1. Enter albums.
  - In live view, press  to enter albums.
  - In live view, press  to call the main menu, and select  to enter albums.
2. Create an album.
  - 1) Tap  in upper right corner to add an album.
  - 2) Edit the album name.
  - 3) Press  to save the album.
3. Rename, delete or set an album as the default saving album.
  - 1) Select an album and press .
  - 2) Tap  in upper right corner of the screen.
  - 3) Select Set as Default Saving Album, Rename or Delete as required.
  - 4) The album icon turns to  when it is set as the default saving album.

## 7.4.2 Manage Files

### *Steps*















1. Enter albums.
  - In live view, press  to enter albums.
  - In live view, press  to call the main menu, and select  to enter albums.
2. Select an album and press .
3. Browse the image and video files.
  - 1) Select a file and press .
  - 2) Press  and  to browse the previous or the next file.
  - 3) Press  to call the operation menu to check more available operations. File formats and their supported operations are shown below.

Table 7-2 File Formats and Operations

File Type	Format	Descriptions
Images	File Name.pd.jpeg File Name.ld.jpeg	Editing text and voice notes, moving files, checking basic information, and deleting files are supported on camera.

File Type	Format	Descriptions
Videos	File Name.pd.mp4 File Name.ld.mp4	Playing, moving and deleting video files are supported on camera.

#### 4. Moving or deleting several files.

- 1) In an album, tap  in the upper right corner of the screen.
- 2) Press  and  to select a file and press . If you want to select all files, tap  in the upper right corner. If you want to cancel all selection, tap .

A selected file displays with a  in its upper right corner.

- 3) Tap Delete or Move.
  - If you tap delete, files are deleted after confirmation.
  - If you tap move, select a target album to start moving.

### 7.4.3 Edit Files

Editing the text, voice or tag notes saved with the images.

#### *Steps*















1. Enter albums.
  - In live view, press  to enter albums.
  - In live view, press  to call the main menu, and select  to enter albums.
2. Select an album and press .
3. Select a file and press  to call the editing menu.
4. Select an option and complete corresponding operations.

Table 7-3 Editing and Managing Images

Icon	Description
	Editing text note. Add a new text note or change the existed note, and press  to save the settings.
	Editing voice note. You can add a new voice note, play or delete an existed voice note. If the file already has a voice note, tap to play or delete the note. If the file has no voice note attached, press  or tap  to record one.

Icon	Description
	<p>Editing tag notes. Tag notes are predefined texts that can be added to the images quickly. Tag note template should be imported to the camera before you can use it. See <i>7.4.4 Import and Manage Tag Note Templates</i>.</p> <ol style="list-style-type: none"> <li>1. Select <b>Tag Note</b>.</li> <li>2. Select a tag name.</li> <li>3. Select tag an option or multiple options, and press <b>OK</b>.</li> <li>4. Press <b>◀</b> and <b>▶</b> to switch to the previous or next tag for configuration.</li> </ol>
	<p>Move the file to other albums. Select a target album and press <b>OK</b> to confirm the moving.</p>
	<p>Show basic information of the file, for example, the saving time and resolution.</p>
	<p>Delete file.</p>
	<p>Play video.</p>

### 7.4.4 Import and Manage Tag Note Templates

Tag note templates contains the predefined tag name and options. With the template imported and activated, users can quick add tags to captured snapshots.

Tag note templates are generated on the client software HIKMICRO Analyzer Acoustic. Copy the templates of json format to the storage of your camera, then you can use and manage the templates.

1. Generate tag note templates on HIKMICRO Analyzer Acoustic.



- Download HIKMICRO Analyzer Acoustic client software from our website. See *7.6 Analyze Snapshot via HIKMICRO Analyzer Acoustic* for more information.
  - Click on  at the upper right corner of the software window to get operation guide.
  - Software generated templates are saved in the path of PC:  
Public\HIKMICRO Analyzer Acoustic\TextRemarkTemplate.
- 

2. Connect your camera to PC by the supplied cable. Copy and paste the template files to the TextNote folder of the camera storage.



If more than one templates are imported, the first template is the active one by default. Up to 10 templates can be imported.

---

3. Go to **Settings > Capture Settings > Tag Note Template** to manage templates.
  - 1) Select a template.
  - 2) Tap on **...** at the upper right corner of screen.
  - 3) Set the template as the default template or delete the template.

## 7.5 Export Files

Connecting the camera to your PC with supplied cable, you can export the recorded videos and captured snapshots.



- Plug the type-C male connector of USB cable to the camera and the other type-A connector to PC.
  - You can export the files using USB cable while the camera is turned off.
  - You can export the files by inserting the memory card to your PC which has a card slot.
- 

### ***Steps***

1. Open the cover of cable interface.
  2. Connect the camera to your PC with cable and open the detected disk.
  3. Select and copy the videos or snapshots to PC to view the files.
  4. Disconnect the camera from your PC.
- 



You can play the recorded videos using the default players.

---

## 7.6 Analyze Snapshot via HIKMICRO Analyzer Acoustic

Captured snapshots can be imported to HIKMICRO Analyzer Acoustic PC client for analysis and report generating.



Visit our website <http://www.hikmicrotech.com>, or contact us to get the software.

Click on  at the upper right corner of the software window to get operation guide.

## 8 Connections

### 8.1 Connect Camera to Wi-Fi

#### *Steps*

1. Enter Wi-Fi setting interface. Choose from the following ways.
  - Tap and hold  from the swipe-down menu.
  - Go to **Settings > Connections > WLAN**.
2. Tap  to enable Wi-Fi, and the searched Wi-Fi will be listed.

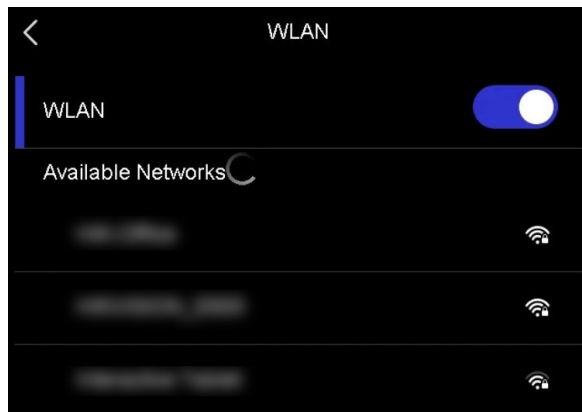



Figure 8-1 Wi-Fi List

3. Select Wi-Fi to connect to and a soft keyboard is displayed.
4. Enter the password.
5. Tap  to hide the keypad and connect Wi-Fi.



- DO NOT tap **space**, or the password may be incorrect.
  - Leaving the Wi-Fi setting interface does not interrupt the connection.
- 

#### *Result*

A Wi-Fi icon  shows in live view interface when the connection is completed.



## 8.2 Set Camera Hotspot

When the camera's hotspot is on, other equipment with Wi-Fi function can join the camera for data transmission.

### Steps



1. Enter hotspot configuration interface. Choose from the following ways.
  - Tap and hold  from swipe-down.
  - Go to **Settings** > **Connections** > **Hotspot**.
2. Tap  to enable hotspot function.



Figure 8-2 Hotspot

3. Set and join the hotspot.

#### Using hotspot password

1. Tap **Set Hotspot**. A soft keyboard is displayed.
2. Set the password for the hotspot by tapping the screen.
3. Tap  to save.
4. Enable the Wi-Fi function of other equipment and search the camera hotspot to join.

#### Using hotspot QR code

1. Scan the QR code using HIKMICRO Viewer to quickly join the hotspot and connect the camera to the APP. For more information about the APP, see *8.4 Connect to HIKMICRO Viewer APP*.





- When setting password, do not tap **space**, or the password may be incorrect.
- The password should be at least 8 digits, consisting of numbers and characters.

## 8.3 Pair Bluetooth Devices

Pair your camera with an external Bluetooth player (speaker or headsets) to play the recorded audios or converted live ultrasonic sound sources.

### *Steps*

1. Enter Bluetooth configuration page. Choose from the following ways.
  - Tap and hold  from swipe-down menu.
  - Select  from the main menu. Go to **Settings > Connections > Bluetooth**.
2. Tap on  to enable the Bluetooth. The camera searches and displays available nearby Bluetooth devices.



Make sure the external Bluetooth device is in discoverable mode.

---

3. Tap to select an external Bluetooth device to start automatic pairing and connecting.



The Bluetooth function is for audio play only. If you want to exporting local files, see *7.5 Export Files* for instructions.

---

## 8.4 Connect to HIKMICRO Viewer APP

HIKMICRO Viewer is a mobile APP working with the camera. With the APP, you can:

- View camera live image.
- Visit camera local album, download snapshots and videos.
- Upgrade camera firmware.

Follow the steps to connect the camera to the APP.

### *Before You Start*

Download and install HIKMICRO Viewer to your phone. Search the APP name in your APP store, or scan the following QR code.



### ***Steps***

1. Add your camera and your phone to the same local network.
  - Use camera Wi-Fi, see *8.1 Connect Camera to Wi-Fi*.
  - Use camera Hotspot, see *8.2 Set Camera Hotspot*.
2. (Ignore this step if camera hotspot is used) Launch the APP, tap on the “+” icon and select **Add Device**.

The APP searches and displays available devices in the local network.
3. Tap on your camera in APP to complete connecting.
4. Tap on **Live View**, **On-Device File**, or **Device Upgrade** to continue.

## 9 Maintenance

### 9.1 View Camera Information



Go to **Settings > Device Settings > Device Information** to view the camera information.

### 9.2 Set Language

Go to **Settings > Device Settings > Language** to set system language.

### 9.3 Set Time and Date

#### *Steps*

1. Press  to show the menu in the live view interface.
2. Go to **Settings > Device Settings > Time and Date**.
3. Set the date and time.
4. Press  to save and exit.



Go to **Settings > Display Settings** to enable or disable time and date on-screen display.

---

### 9.4 Upgrade Camera

Upgrade the camera via an upgrade file, or via HIKMICRO View APP.

### 9.4.1 Upgrade with HIKMICRO Viewer APP

Connect your camera to HIKMICRO Viewer APP and tap on **Device Upgrade** to check camera firmware version and proceed online upgrading. See 8.4 *Connect to HIKMICRO Viewer APP* for more details.

### 9.4.2 Upgrade with an Upgrade File

#### *Before You Start*

- Please download the upgrade file from the official website <http://www.hikmicrotech.com> or contact the customer service and technical support to get the upgrade file first.
- Make sure that the camera battery is fully charged.
- Make sure that Auto Power-off function is turned-off to avoid accidental suspension during upgrading.
- Make sure that a memory card has been installed to camera.

#### *Steps*

1. Connect the camera to your PC with a type-C to type A cable and open the detected disk.
2. Copy the upgrade file and paste it to the root directory of the camera.
3. Disconnect the camera from your PC.
4. Reboot the camera and then it will upgrade automatically. The upgrading process will be displayed in the main interface.



After upgrading, the camera reboots automatically. You can view the current version in **Settings > Device Settings > Device Information**.

---

## 9.5 Restore Camera

You can default the camera to the factory settings.

---



This function should be used with caution.

---

#### *Steps*

1. Press **OK** to show the menu in the live view interface.
2. Go to **Settings > Device Settings > Device Initialization**.
3. Select **Restore Device**. A prompt appears.
  - **OK**: Tap **OK** to initialize the device.
  - **Cancel**: Tap **Cancel** to exit and return to the previous menu.

## 9.6 Record Sound Source for Trouble Shooting

Record sound source function is to save original audio files for trouble shooting when microphone error occurs.

### *Steps*

1. Go to **Settings > Capture Settings > Record Sound Source** to enable the function.
2. Return to live view, aim the microphone array to a sound source and hold the trigger to start video recording.
3. Pull the trigger to stop recording. Or the recording stops when it reaches the maximum length (20 seconds).
4. Export the audio file and send the file to your dealer or our technical support for trouble shooting.



- The audio files are not available in the local album. Connect your camera to a PC, then check and export the files, see *7.5 Export Files* for instructions.
  - The audio files are saved in DCIM folder. The file name is the same as the video file, and the format is \*.sonic.
- 

## 9.7 Save Log

Camera supports saving operation logs for trouble shooting. The logs are saved in log folder under the root directory of the camera storage/memory card. Connect the camera to a PC to export the logs.

### *Steps*

1. Go to **Settings > Device Settings > Save Log** to enable the function.
2. Camera starts saving operation logs. It stops when you turn off the function or when the camera restarts or powers off.



You need to enable the function again if you need the camera to save logs after a restart.

---

3. Visit the device storage/memory card and copy the log files (\*.tar) to your PC and send the file to our technical support. See *7.5 Export Files* for instructions.

## 10 More Information

Scan the following QR code to get device common FAQ.





## Legal Information

© Hangzhou Microimage Software Co., Ltd. All rights reserved.

### About this Manual

The Manual includes instructions for using and managing the Product. Pictures, charts, images and all other information hereinafter are for description and explanation only. The information contained in the Manual is subject to change, without notice, due to firmware updates or other reasons. Please find the latest version of this Manual at the HIKMICRO website (<http://www.hikmicrotech.com>).

Please use this Manual with the guidance and assistance of professionals trained in supporting the Product.

### Trademarks

 **HIKMICRO** and other HIKMICRO's trademarks and logos are the properties of HIKMICRO in various jurisdictions.

**HDMI**<sup>™</sup>: The terms HDMI and HDMI High-Definition Multimedia Interface, and the HDMI Logo are trademarks or registered trademarks of HDMI Licensing Administrator, Inc. in the United States and other countries.

Other trademarks and logos mentioned are the properties of their respective owners.

### Disclaimer

TO THE MAXIMUM EXTENT PERMITTED BY APPLICABLE LAW, THIS MANUAL AND THE PRODUCT DESCRIBED, WITH ITS HARDWARE, SOFTWARE AND FIRMWARE, ARE PROVIDED "AS IS" AND "WITH ALL FAULTS AND ERRORS". HIKMICRO MAKES NO WARRANTIES, EXPRESS OR IMPLIED, INCLUDING WITHOUT LIMITATION, MERCHANTABILITY, SATISFACTORY QUALITY, OR FITNESS FOR A PARTICULAR PURPOSE. THE USE OF THE PRODUCT BY YOU IS AT YOUR OWN RISK. IN NO EVENT

WILL HIKMICRO BE LIABLE TO YOU FOR ANY SPECIAL, CONSEQUENTIAL, INCIDENTAL, OR INDIRECT DAMAGES, INCLUDING, AMONG OTHERS, DAMAGES FOR LOSS OF BUSINESS PROFITS, BUSINESS INTERRUPTION, OR LOSS OF DATA, CORRUPTION OF SYSTEMS, OR LOSS OF DOCUMENTATION, WHETHER BASED ON BREACH OF CONTRACT, TORT (INCLUDING NEGLIGENCE), PRODUCT LIABILITY, OR OTHERWISE, IN CONNECTION WITH THE USE OF THE PRODUCT, EVEN IF HIKMICRO HAS BEEN ADVISED OF THE POSSIBILITY OF SUCH DAMAGES OR LOSS.

YOU ACKNOWLEDGE THAT THE NATURE OF THE INTERNET PROVIDES FOR INHERENT SECURITY RISKS, AND HIKMICRO SHALL NOT TAKE ANY RESPONSIBILITIES FOR ABNORMAL OPERATION, PRIVACY LEAKAGE OR OTHER DAMAGES RESULTING FROM CYBER-ATTACK, HACKER ATTACK, VIRUS INFECTION, OR OTHER INTERNET SECURITY RISKS; HOWEVER, HIKMICRO WILL PROVIDE TIMELY TECHNICAL SUPPORT IF REQUIRED.

YOU AGREE TO USE THIS PRODUCT IN COMPLIANCE WITH ALL APPLICABLE LAWS, AND YOU ARE SOLELY RESPONSIBLE FOR ENSURING THAT YOUR USE CONFORMS TO THE APPLICABLE LAW. ESPECIALLY, YOU ARE RESPONSIBLE, FOR USING THIS PRODUCT IN A MANNER THAT DOES NOT INFRINGE ON THE RIGHTS OF THIRD PARTIES, INCLUDING WITHOUT LIMITATION, RIGHTS OF PUBLICITY, INTELLECTUAL PROPERTY RIGHTS, OR DATA PROTECTION AND OTHER PRIVACY RIGHTS. YOU SHALL NOT USE THIS PRODUCT FOR ANY PROHIBITED END-USES, INCLUDING THE DEVELOPMENT OR PRODUCTION OF WEAPONS OF MASS DESTRUCTION, THE DEVELOPMENT OR PRODUCTION OF CHEMICAL OR BIOLOGICAL WEAPONS, ANY ACTIVITIES IN THE CONTEXT RELATED TO ANY NUCLEAR EXPLOSIVE OR UNSAFE NUCLEAR FUEL-CYCLE, OR IN SUPPORT OF HUMAN RIGHTS ABUSES.

IN THE EVENT OF ANY CONFLICTS BETWEEN THIS MANUAL AND THE APPLICABLE LAW, THE LATTER PREVAILS.

## Regulatory Information

---

These clauses apply only to the products bearing the corresponding mark or information.

---

### **FCC Compliance Statement**

Please take attention that changes or modification not expressly approved by the party responsible for compliance could void the user's authority to operate the equipment.

This device complies with part 15 of the FCC Rules. Operation is subject to the following two conditions:

- (1) this device may not cause harmful interference, and
- (2) this device must accept any interference received, including interference that may cause undesired operation.

This equipment complies with FCC radiation exposure limits set forth for an uncontrolled environment.

### **For models with 136 microphone array:**

Note: This product has been tested and found to comply with the limits for a Class B digital device, pursuant to part 15 of the FCC Rules. These limits are designed to provide reasonable protection against harmful interference in a residential installation. This product generates, uses, and can radiate radio frequency energy and, if not installed and used in accordance with the instructions, may cause harmful interference to radio communications. However, there is no guarantee that interference will not occur in a particular installation. If this product does cause harmful interference to radio or television reception, which can be determined by turning the equipment off and on, the user is encouraged to try to correct the interference by one or more of the following measures:

- Reorient or relocate the receiving antenna.
- Increase the separation between the equipment and receiver.
- Connect the equipment into an outlet on a circuit different from that to which the receiver is connected.
- Consult the dealer or an experienced radio/TV technician for help.

### **For models with 64 microphone array:**

Note: This equipment has been tested and found to comply with the limits for a Class A digital device, pursuant to part 15 of the FCC Rules. These limits are designed to provide reasonable protection against harmful interference when the equipment is operated in a commercial environment. This equipment generates, uses, and can radiate radio frequency energy and, if not installed and used in accordance with the instruction manual, may cause harmful interference to radio communications. Operation of this equipment in a residential area is likely to cause harmful interference in which case the user will be required to correct the interference at his own expense.

### **EU Conformity Statement**



This product and - if applicable - the supplied accessories too are marked with "CE" and comply therefore with the applicable harmonized European standards listed under the Directive 2014/30/EU (EMCD), Directive 2014/35/EU (LVD), Directive 2011/65/EU (RoHS).

Hereby, Hangzhou Microimage Software Co., Ltd. declares that this device (refer to the label) is in compliance with Directive 2014/53/EU.

The full text of the EU declaration of conformity is available at the following internet address:

<https://www.hikmicrotech.com/en/support/download-center/declaration-of-conformity/>

### **Restrictions in the 5 GHz band:**

According to Article 10 (10) of Directive 2014/53/EU, when operating in the 5150 to 5350 MHz frequency range, this device is restricted to indoor use in: Austria (AT), Belgium (BE), Bulgaria (BG), Croatia (HR), Cyprus (CY), the Czech Republic (CZ), Denmark (DK), Estonia (EE), Finland (FI), France (FR), Germany (DE), Greece (EL), Hungary (HU), Iceland (IS), Ireland (IE), Italy (IT), Latvia (LV), Liechtenstein (LI), Lithuania (LT), Luxembourg (LU), Malta (MT), Netherlands (NL), Northern Ireland (UK(NI)), Norway (NO), Poland (PL), Portugal (PT), Romania (RO), Slovakia (SK), Slovenia (SI), Spain (ES), Sweden (SE), Switzerland (CH), and Turkey (TR).

## Frequency Bands and Power

The frequency bands and modes and transmitting power (radiated and/or conducted) nominal limits applicable to the following radio equipment are as follows:

**Wi-Fi:** 2.4 GHz (2.4 GHz to 2.4835 GHz): 20 dBm; 5 GHz (5.15 GHz to 5.25 GHz): 23 dBm; 5 GHz (5.25 GHz to 5.35 GHz): 23 dBm; 5 GHz (5.47 GHz to 5.725GHz): 23 dBm; 5 GHz (5.725 GHz to 5.85 GHz): 14 dBm

Use the power adapter provided by a qualified manufacturer. Refer to the product specification for detailed power requirements.

Use the battery provided by a qualified manufacturer. Refer to the product specification for detailed battery requirements.



Directive 2012/19/EU (WEEE Directive): Products marked with this symbol cannot be disposed of as unsorted municipal waste in the European Union. For proper recycling, return this product to your local supplier upon the purchase of equivalent new equipment, or dispose of it at designated collection points. For more information see: [www.recyclethis.info](http://www.recyclethis.info)



Directive 2006/66/EC and its amendment 2013/56/EU (Battery Directive): This product contains a battery that cannot be disposed of as unsorted municipal waste in the European Union. See the product documentation for specific battery information. The battery is marked with this symbol, which may include lettering to indicate cadmium (Cd), lead (Pb), or mercury (Hg). For proper recycling, return the battery to your supplier or to a designated collection point. For more information see: [www.recyclethis.info](http://www.recyclethis.info).

## Industry Canada ICES-003 Compliance/Conformité Industrie Canada ICES-003

### For models with 136 microphone array:

This device meets the CAN ICES-003 (B) / NMB-003 (B) standards requirements.

Cet appareil répond aux exigences des normes CAN ICES-003 (B)/NMB-003 (B).

**For models with 64 microphone array:**

This device meets the CAN ICES-003 (A) / NMB-003 (A) standards requirements.

Cet appareil répond aux exigences des normes CAN ICES-003 (A)/NMB-003 (A).

This device complies with Industry Canada licence-exempt RSS standard(s). Operation is subject to the following two conditions:

- (1) this device may not cause interference, and
- (2) this device must accept any interference, including interference that may cause undesired operation of the device.

This equipment complies with IC RSS-102 radiation exposure limits set forth for an uncontrolled environment.

For this device, please pay attention to the following notes when the device is operating in 5 GHz:

(i) The device for operation in the band 5150-5250 MHz is only for indoor use to reduce the potential for harmful interference to co-channel mobile satellite systems;

(ii) The maximum antenna gain permitted for devices in the bands 5250-5350 MHz and 5470-5725 MHz shall comply with the e.i.r.p. limit; and

(iii) The maximum antenna gain permitted for devices in the band 5725-5825 MHz shall comply with the e.i.r.p. limits specified for point-to-point and non point-to-point operation as appropriate.

Users should also be advised that high-power radars are allocated as primary users (i.e. priority users) of the bands 5250-5350 MHz and 5650-5850 MHz and that these radars could cause interference and/or damage to LE-LAN devices.

Le présent appareil est conforme aux CNR d'Industrie Canada applicables aux appareils radioexempts de licence. L'exploitation est autorisée aux deux conditions suivantes :

- (1) l'appareil ne doit pas produire de brouillage, et
- (2) l'utilisateur de l'appareil doit accepter tout brouillage radioélectrique subi, même si le brouillage est susceptible d'en compromettre le fonctionnement.

ce matériel est conforme aux limites de dose d'exposition aux rayonnements, CNR-102 énoncée dans un autre environnement.

(i) Les dispositifs fonctionnant dans la bande 5150-5250 MHz sont réservés uniquement pour une utilisation à l'intérieur afin de réduire les risques de brouillage préjudiciable aux systèmes de satellites mobiles utilisant les mêmes canaux.

(ii) Le gain d'antenne maximal autorisé pour les appareils dans les bandes 5250-5350 MHz et 5470-5725 MHz doivent respecter le pire limiter; et

(iii) Le gain d'antenne maximal autorisé pour les appareils dans la bande 5725-5825 MHz doivent respecter le pire limites spécifiées pour le point-à-point et l'exploitation non point à point, le cas échéant.

Les utilisateurs de radars de haute puissance sont désignés utilisateurs principaux (c.-à-d., qu'ils ont la priorité) pour les bandes 5250-5350 MHz et 5650-5850 MHz et que ces radars pourraient causer du brouillage et/ou des dommages aux dispositifs LAN-EL.

### KC

#### **For models with 136 microphone array:**

B 급 기기: 이 기기는 가정용(B 급) 전자파적합기기로서 주로 가정에서 사용하는 것을 목적으로 하며, 모든 지역에서 사용할 수 있습니다.

#### **For models with 64 microphone array:**

A 급 기기: 이 기기는 업무용(A 급) 전자파적합기기로서 판매자 또는 사용자는 이 점을 주의하시기바라며, 가정 외의 지역에서 사용하는 것을 목적으로 합니다.

### INFORMATIONEN FÜR PRIVATE HAUSHALTE

1. Getrennte Erfassung von Altgeräten: 1. Getrennte Erfassung von Altgeräten:

Elektro- und Elektronikgeräte, die zu Abfall geworden sind, werden als Altgeräte bezeichnet. Besitzer von Altgeräten haben diese einer vom unsortierten Siedlungsabfall getrennten Erfassung zuzuführen. Altgeräte gehören insbesondere nicht in den Hausmüll, sondern in spezielle Sammel- und Rückgabesysteme.

2. Batterien und Akkus sowie Lampen:

Besitzer von Altgeräten haben Altbatterien und Altakkumulatoren, die nicht vom Altgerät umschlossen sind, die zerstörungsfrei aus dem Altgerät entnommen werden können, im Regelfall vor der Abgabe an einer Erfassungsstelle vom Altgerät zu trennen. Dies gilt nicht, soweit Altgeräte einer Vorbereitung zur Wiederverwendung unter Beteiligung eines

öffentlich-rechtlichen Entsorgungsträgers zugeführt werden.

### 3. Möglichkeiten der Rückgabe von Altgeräten:

Besitzer von Altgeräten aus privaten Haushalten können diese bei den Sammelstellen der öffentlich-rechtlichen Entsorgungsträger oder bei den von Herstellern oder Vertriebern im Sinne des ElektroG eingerichteten Rücknahmestellen unentgeltlich abgeben. Rücknahmepflichtig sind Geschäfte mit einer Verkaufsfläche von mindestens 400 m<sup>2</sup> für Elektro- und Elektronikgeräte sowie diejenigen Lebensmittelgeschäfte mit einer Gesamtverkaufsfläche von mindestens 800 m<sup>2</sup>, die mehrmals pro Jahr oder dauerhaft Elektro- und Elektronikgeräte anbieten und auf dem Markt bereitstellen. Dies gilt auch bei Vertrieb unter Verwendung von Fernkommunikationsmitteln, wenn die Lager- und Versandflächen für Elektro- und Elektronikgeräte mindestens 400 m<sup>2</sup> betragen oder die gesamten Lager- und Versandflächen mindestens 800 m<sup>2</sup> betragen. Verreiber haben die Rücknahme grundsätzlich durch geeignete Rückgabemöglichkeiten in zumutbarer Entfernung zum jeweiligen Endnutzer zu gewährleisten. Die Möglichkeit der unentgeltlichen Rückgabe eines Altgerätes besteht bei rücknahmepflichtigen Verreibern unter anderem dann, wenn ein neues gleichartiges Gerät, das im Wesentlichen die gleichen Funktionen erfüllt, an einen Endnutzer abgegeben wird.

### 4. Datenschutz-Hinweis:

Altgeräte enthalten häufig sensible personenbezogene Daten. Dies gilt insbesondere für Geräte der Informations- und Telekommunikationstechnik wie Computer und Smartphones. Bitte beachten Sie in Ihrem eigenen Interesse, dass für die Löschung der Daten auf den zu entsorgenden Altgeräten jeder Endnutzer selbst verantwortlich ist.

### 5. Bedeutung des Symbols „durchgestrichene Mülltonne“:



Das auf Elektro- und Elektronikgeräten regelmäßig abgebildete Symbol einer durchgestrichenen Mülltonne weist darauf hin, dass das jeweilige Gerät am Ende seiner Lebensdauer getrennt vom unsortierten Siedlungsabfall zu erfassen ist.





**HIKMICRO**

See the World in a New Way