

USER MANUAL

METER FOR ELECTRICAL INSTALLATION PARAMETERS

MPI-540 • MPI-540-PV

MPI-540 • MPI-540-PV

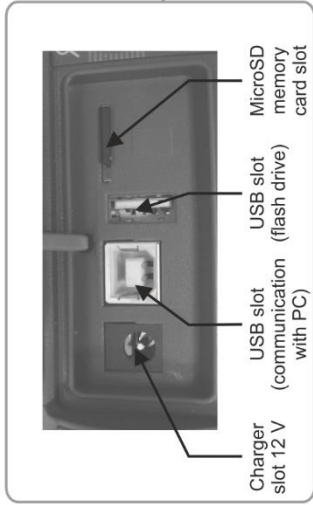

Clamps slots
I1, I2, I3 - recorder
 R_e - measurement
of earth systems

Measuring
terminals

Recorder N socket
ES socket for measuring
earth resistance and soil
resistivity



Starting
the measurement
procedure

Contact
electrode

Touchscreen

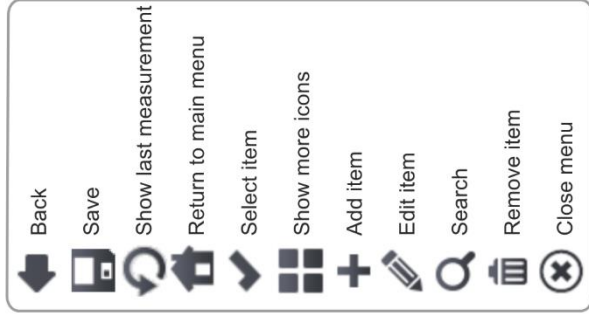



USER MANUAL

METER FOR ELECTRICAL INSTALLATION PARAMETERS MPI-540 • MPI-540-PV



**SONEL S.A.
Wokulskiego 11
58-100 Świdnica
Poland**

Version 2.10 16.10.2023

MPI-540 / 540-PV meter is a modern, easy in use and safe measuring device. Please acquaint yourself with this manual in order to avoid measuring errors and prevent possible problems in operation of the meter.

CONTENTS

1 Safety	7
2 Main menu	8
2.1 Meter settings	9
2.1.1 Setting date and time	10
2.1.2 Automatic shutdown	11
2.1.3 Display parameters	12
2.2 Settings of measurements	13
2.2.1 Sub-menu Measurements	13
2.2.2 Sub-menu Edit fuses	14
a. Adding fuse characteristics	14
b. Adding fuses	19
2.2.3 MPI-540-PV Sub-menu PV modules	21
2.3 Communication	22
2.3.1 USB communication	22
2.3.2 Connection to a Wi-Fi network	22
2.3.3 MPI-540-PV Connection with an irradiance meter	22
2.3.4 E-mail settings	23
2.4 Software update	23
2.4.1 Update via USB	23
2.4.2 Update via Wi-Fi	24
2.5 Regional settings	24
2.6 Meter information	25
3 Measurements	26
3.1 Diagnostics performed by the meter – limits	27
3.2 Measurement of alternating voltage and frequency	27
3.3 Checking the correctness of PE (protective earth) connections	28
3.4 Fault loop parameters	29
3.4.1 Settings of measurements	29
3.4.2 Fault loop parameters in the L-N and L-L circuits	31
3.4.3 Fault loop parameters in the L-PE circuit	34
3.4.4 Fault loop impedance in L-PE circuit protected with a residual current device (RCD)	37
3.4.5 Prospective short-circuit current	40
3.4.6 Measurement of fault loop impedance in IT networks	41
3.5 Voltage drop	42
3.6 Resistance-to-earth	44
3.6.1 Settings of measurements	44
3.6.2 Earth resistance measurement with 3-pole method (R_{E3P})	46
3.6.3 Earth resistance measurement with 4-wire method (R_{E4P})	50
3.6.4 Earth resistance measurement with 3-pole method with additional clamp (R_{E3P+C})	54
3.6.5 Earth resistance measurement with two-clamp method (2C)	58
3.7 Soil resistivity	61
3.7.1 Settings of measurements	61
3.7.2 Main elements of the screen	62
3.7.3 Soil resistivity measurements (ρ)	63
3.8 RCD parameters	67
3.8.1 Settings of measurements	67
3.8.2 RCD tripping current	70
3.8.3 RCD tripping time	73
3.8.4 Measurements in IT networks	76
3.9 Automatic measurements of RCD parameters	77

3.9.1	Setting automatic measurements of RCD parameters.....	77
3.9.2	Automatic measurement of RCDs.....	78
3.10	Insulation resistance	82
3.10.1	Settings of measurements	82
3.10.2	Measurement using probes.....	86
3.10.3	Measurements using UNI-Schuko adapter (WS-03 and WS-04)	88
3.10.4	Measurements using AutoISO-1000c.....	91
3.11	Low-voltage resistance measurement.....	95
3.11.1	Resistance measurement	95
3.11.2	Measurement of resistance of protective conductors and equipotential bonding with ± 200 mA current.....	98
3.12	Phase sequence	102
3.13	Motor rotation direction.....	103
3.14	Illuminance	105
3.15	MPI-540-PV Resistance-to-earth (PV).....	106
3.16	MPI-540-PV Insulation resistance (PV).....	107
3.17	MPI-540-PV Continuity of connections (PV)	107
3.18	MPI-540-PV Open circuit DC voltage U_{oc}	108
3.19	MPI-540-PV Short circuit DC current I_{sc}	109
3.20	MPI-540-PV Test of the inverter panel η , P , I	110
3.20.1	Measurement configuration.....	111
3.20.2	Live mode.....	114
3.21	MPI-540-PV Resetting C-PV clamp	115
3.22	MPI-540-PV Irradiance and temperature	115
4	Auto measurements	116
4.1	Proceeding auto measurements	116
4.2	Creating measurement procedures	118
5	Recorder	120
5.1	Functional Description.....	120
5.2	Main elements of the screen	122
5.2.1	Top bar	123
5.2.2	Title bar	123
5.2.3	Main window.....	124
5.2.4	Information bar on the parameters of the current network	124
5.2.5	Help.....	124
5.3	Connecting the measuring system	125
5.3.1	Measuring arrangements	125
5.3.2	Verifying the connection.....	128
5.4	Recording configuration	129
5.4.1	Configuration using the meter	129
5.4.2	Recording configuration	130
5.5	Analyzer settings.....	133
5.5.1	Hardware settings – clamps (manner of connecting).....	133
5.5.2	Settings – Regional settings.....	134
5.5.3	Managers – file manager	136
a.	Data viewing	136
b.	Data preview.....	137
5.6	LIVE mode of the network.....	138
5.6.1	Transient waveforms of current and voltages (waveforms).....	138
5.6.2	Timeplot of effective values.....	140
5.6.3	"Live" mode - tabular view.....	141
5.6.4	Vector diagram of fundamental components (phasor).....	143

5.6.5	Harmonics graph/table.....	144
5.7	Switching the recording on/off.....	146
5.7.1	Approximate recording times.....	146
5.7.2	Recording guidelines.....	147
5.8	Recording analysis.....	148
5.8.1	Recording timeplot.....	151
a.	Functional Description.....	151
b.	Selecting parameters for the timeplot.....	153
c.	Creating and managing a timeplot.....	154
5.8.2	Harmonics waveform graph.....	156
5.8.3	Event list.....	158
5.8.4	Energy costs calculator.....	161
a.	Functional Description.....	161
b.	Settings of the energy cost calculator.....	162
5.9	Energy loss calculator.....	164
5.9.1	Functional Description.....	164
5.9.2	Configuration of the loss calculator.....	165
5.10	Inverter efficiency.....	166
6	Memory of the meter.....	167
6.1	Memory of measurements.....	167
6.1.1	Memory settings.....	167
6.1.2	Structure of the memory.....	168
a.	Fundamentals of navigating the Memory menu.....	169
b.	Adding a new measurements tree.....	171
6.1.3	Entering the measurement result.....	176
6.1.4	Viewing saved measurements.....	177
6.1.5	Sharing recorded measurements.....	179
6.1.6	Searching the meter memory.....	180
6.2	Recorder memory.....	181
6.2.1	microSD Memory Card.....	181
6.2.2	USB external memory (flash drive).....	181
6.2.3	Compatibility with Sonel Analysis software.....	181
6.2.4	PC connection and data transmission.....	182
7	Power supply.....	183
7.1	Monitoring of the battery charge status.....	183
7.2	Replacing rechargeable batteries.....	183
7.3	Charging the rechargeable batteries.....	184
7.4	General rules for using Li-Ion rechargeable batteries.....	185
8	Cleaning and maintenance.....	186
9	Storage.....	186
10	Dismantling and utilisation.....	186
11	Technical data.....	187
11.1	Basic data.....	187
11.1.1	Measurement of alternating voltages (True RMS).....	187
11.1.2	Frequency measurement.....	187
11.1.3	Measurement of fault loop impedance Z_{L-PE} , Z_{L-N} , Z_{L-L}	187
11.1.4	Measurement of fault loop impedance $Z_{L-PE(RCD)}$ (without triggering of RCD).....	188
11.1.5	Measurement of parameters of RCD.....	189
11.1.6	Measurement of resistance-to-earth R_E	192
11.1.7	Low-voltage measurement of continuity of circuit and resistance.....	193

11.1.8	Measurement of insulation resistance	194
11.1.9	Light measurements	195
11.1.10	Phase sequence	196
11.1.11	Motor rotation	196
11.1.12	MPI-540-PV Measurement of open circuit DC voltage U_{OC}	196
11.1.13	MPI-540-PV Measurement of short circuit DC current I_{SC}	196
11.2	Recorder data	196
11.2.1	Inputs	196
11.2.2	Sampling and RTC	197
11.2.3	Voltage measurement	197
11.2.4	Measurement of current (True RMS)	198
11.2.5	Frequency measurement	198
11.2.6	Measuring harmonics	199
11.2.7	Unbalance	199
11.2.8	Power and energy measurement	199
11.2.9	Estimated measurement uncertainty values for power and energy	200
11.3	Other technical data	201
11.4	Additional data	202
11.4.1	Additional uncertainties according to IEC 61557-2 (R_{ISO})	202
11.4.2	Additional uncertainties according to IEC 61557-3 (Z)	202
11.4.3	Additional uncertainties according to IEC 61557-4 ($R \pm 200$ mA)	202
11.4.4	Additional uncertainties of earth resistance measurement (R_E)	202
11.4.5	Additional uncertainties according to IEC 61557-6 (RCD)	203
11.5	List of reference standards	203
12	Optional accessories	204
12.1.1	MPI-540-PV C-PV clamp	205
13	Positions of the meter's cover	206
14	Manufacturer	206

1 Safety

MPI-540 meter is designed for performing check tests of protection against electric shock in AC mains systems and recording the parameters of electric mains. The meter is used for making measurements and providing results to determine safety of electrical installations. Therefore, in order to provide conditions for correct operation and accuracy of obtained results, the following recommendations must be observed:

- Before you proceed to operate the meter, acquaint yourself thoroughly with the present manual and observe the safety regulations and specifications provided by the producer.
- Any application that differs from those specified in the present manual may result in a damage to the device and constitute a source of danger for the user.
- MPI-540 meters must be operated only by appropriately qualified personnel with relevant certificates authorising the personnel to perform works on electric systems. Operating the meter by unauthorised personnel may result in damage to the device and constitute a source of danger for the user.
- Using this manual does not exclude the need to comply with occupational health and safety regulations and with other relevant fire regulations required during the performance of a particular type of work. Before starting the work with the device in special environments, e.g. potentially fire-risk/explosive environment, it is necessary to consult it with the person responsible for health and safety.
- It is unacceptable to operate:
 - ⇒ a damaged meter which is completely or partially out of order,
 - ⇒ a meter with damaged insulation,
 - ⇒ a meter stored for an excessive period of time in disadvantageous conditions (e.g. excessive humidity). If the meter has been transferred from a cool to a warm environment with a high level of relative humidity, do not start measurements until the meter is warmed up to the ambient temperature (approximately 30 minutes).
- If the battery is discharged to a level preventing further measurements, the meter displays an appropriate message and then turns off.
- Battery spill and damage to the meter may occur if discharged batteries are left in the meter.
- Before measurements may commence, make sure the leads are connected to the appropriate measurement sockets.
- Do not operate a meter with an open or incorrectly closed battery (accumulator) compartment or power it from other sources than those specified in the present manual.
- **R_{ISO}** meter inputs are electronically protected against overloads (caused by e.g. connecting the meter to a live circuit) up to 463 V RMS for 60 seconds.
- Repairs may be performed only by an authorised service point.



NOTE!

Only accessories for a given device should be used. Using other accessories may cause damage to measuring terminals, introduce additional measurement error and create a risk for the user.



Due to continuous development of the meter's software, the actual appearance of the display, in case of some of the functions, may slightly differ from the display presented in this operating manual.

2 Main menu

The main screen is available:

- after the meter has been turned on,
- at any time after the  icon has been selected on the display (does not apply to the recorder).

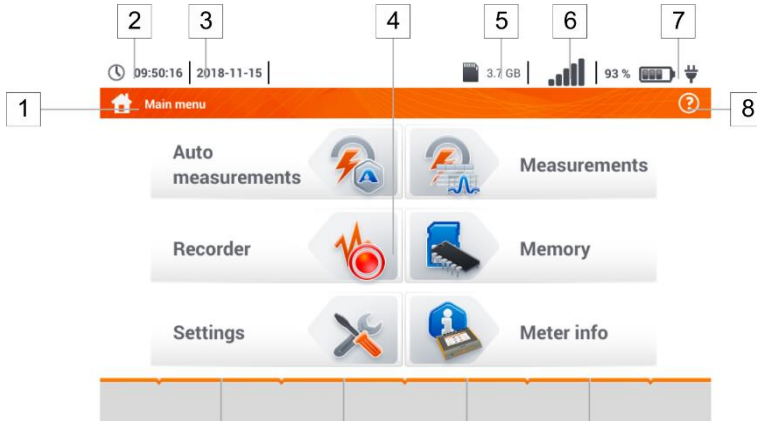

Fig. 2.1 Main elements of the screen

1 Name of the active menu

The fact of introducing a change that has not been saved yet is indicated by the * symbol in the screen header.



2 Time

3 Date

4 Main screen

5 Free space on the memory card

If the card is not in the slot, the icon on the screen is crossed out.

6 Wireless network signal strength

7 Battery discharge indicator

8 Active menu help

- Visualisation of connection systems
- Explanation of icons

Touching a selected main menu item redirects to the sub-menu. Available options:

- **Recorder** – measurement of electrical parameters of the tested network. The description of the recording mode is provided in **section 5**,
- **Settings** – going to the settings of the main functions and parameters of the meter,

- **Measurements** – Selecting the measurement function. The description of individual functions is provided in **section 3** ,
- **Memory** – viewing and managing the saved measurement results. A detailed description of the function is provided in **section 6.1** ,
- Meter information.

2.1 Meter settings

The **date** , **time** and display **brightness** can be set from the **Meter settings** screen level.

①  In the main menu select **Settings**.

②  Select **Meter settings**

③  Parameters to change
 ⇒ Date and time (**section 2.1.1**)
 ⇒ Auto off (**section 2.1.2**)
 ⇒ Display (**section 2.1.3**)

2.1.1 Setting date and time

①

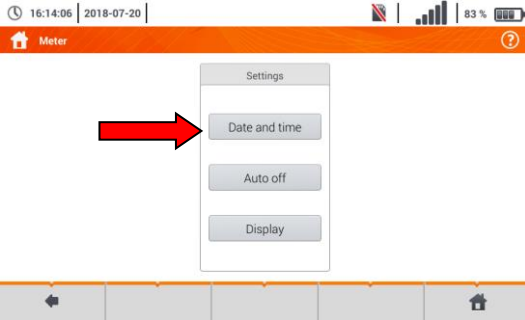

Select **Date and time**.

②

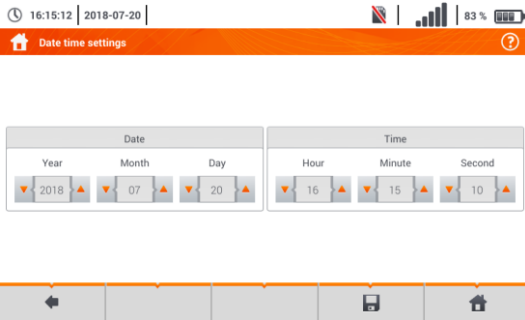

Touch the appropriate icon to modify the selected parameter:

▲ value increase by 1,

▼ value decrease by 1,

2018 touching opens the field for manual entering of the value (step ③).

③

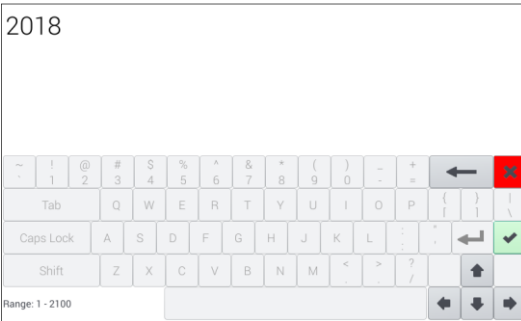

Delete the existing entry and enter the required value manually.

Functions of icons

✖ reject the changes and return to step ②



✓ accept changes and go to step

④

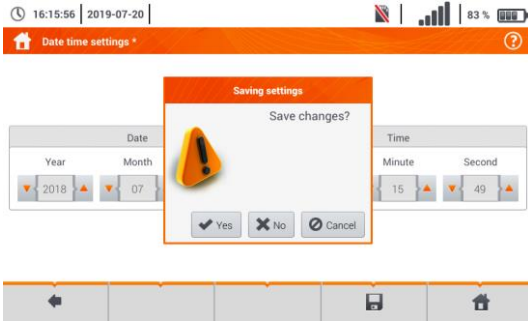
4



Description of function icons

- ← return to the previous screen
- After touching the icon you may be prompted to save or reject changes (figure):
 - Yes** – accept selection,
 - No** – reject changes,
 - Cancel** – cancel the action
-  saving changes
-  return to the main menu

2.1.2 Automatic shutdown

1

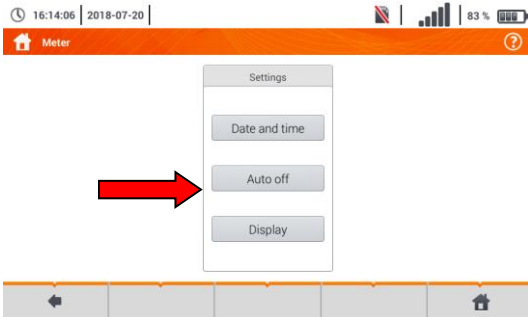

Select **Auto off**.

2

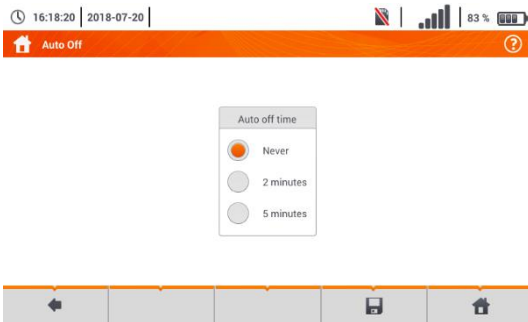

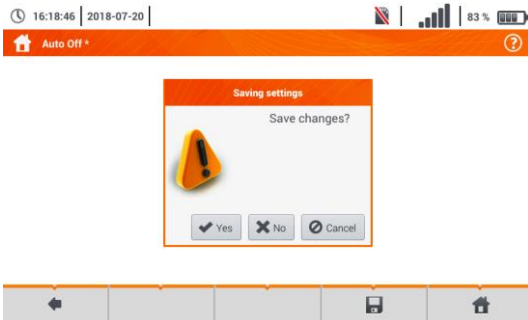

Select the required option.

3



Description of function icons

- ← return to the previous screen
- After touching the icon you may be prompted to save or reject changes (figure):
 - Yes** – accept selection,
 - No** – reject changes,
 - Cancel** – cancel the action
-  saving changes
-  return to the main menu

2.1.3 Display parameters

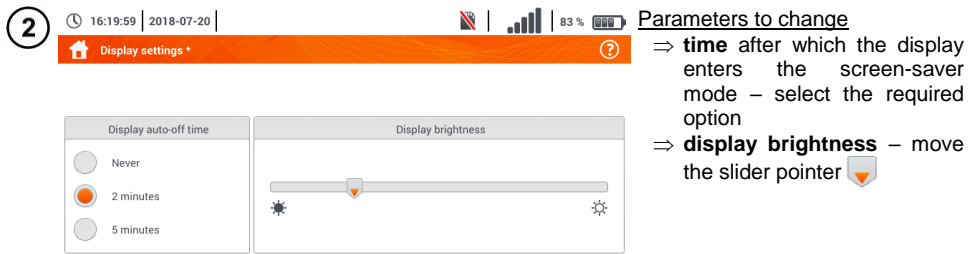
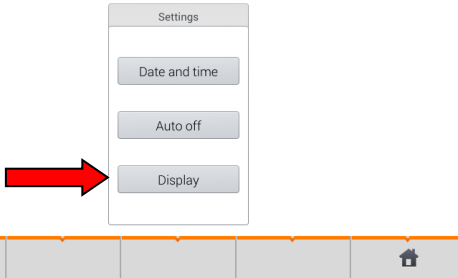

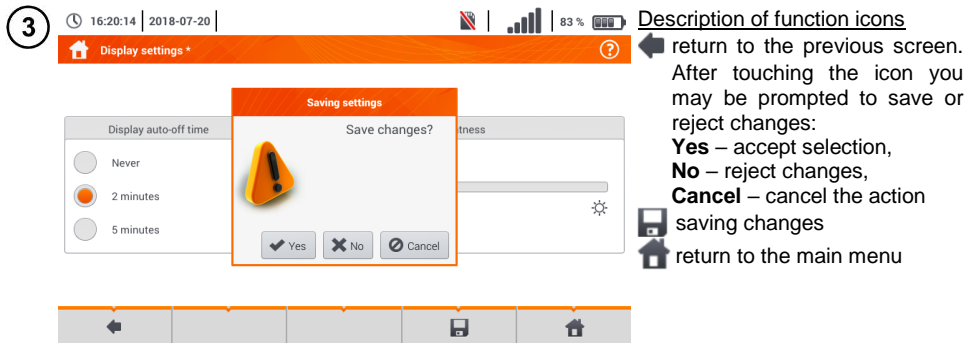

Parameters to change

- ⇒ **time** after which the display enters the screen-saver mode – select the required option
- ⇒ **display brightness** – move the slider pointer 



Description of function icons

-  return to the previous screen. After touching the icon you may be prompted to save or reject changes:
 - Yes** – accept selection,
 - No** – reject changes,
 - Cancel** – cancel the action
-  saving changes
-  return to the main menu

2.2 Settings of measurements

From the **Measurement settings** menu it is possible to edit:

- network parameters,
- fuses database,
- **MPI-540-PV** photovoltaic installation parameters,
- **MPI-540-PV** photovoltaic modules database.

2.2.1 Sub-menu Measurements

The option of **Measurements** consists of:

- mains rated voltage,
- network frequency,
- manner of presentation of short-circuit loop result,
- type of mains for the tested object,
- system of units,
- memory settings (auto-incrementing memory cells),
- auto measurements timer,
- **MPI-540-PV** minimum value of irradiance for conversion of STC conditions,
- **MPI-540-PV** temperature measurement source,
- **MPI-540-PV** the number of photovoltaic modules in series,
- **MPI-540-PV** the number of photovoltaic modules in parallel,
- RCD EV measurement standard.

Before the measurements select the **type of mains** from which the tested object is powered. Then select **the mains rated voltage** U_n (110/190 V, 115/200 V, 127/220 V, 220/380 V, 230/400 V or 240/415 V). This voltage value is used for calculating the values of prospective short-circuit current.

Determination of **network frequency** that is the source of potential interferences is necessary in order to select a proper measuring signal frequency in resistance-to-earth measurements. This selection ensures optimum interference filtering. The meter is designed for filtration of interferences generated by 50 Hz and 60 Hz networks.

RCD EV measurement standard defines the parameters for measuring RCD protectors dedicated to the field of electromobility and photovoltaics.

Setting **Autoincrementing** as active (→) causes each saved measurement (**section 6.1.3**) to be placed in an automatically created new measurement point (**section b** step ⑭).

Auto measurements timer determines the time interval of starting subsequent steps of the measurement procedure.

⑭



- Expand the selection list using the  icon.
- Select the required parameter value.

2

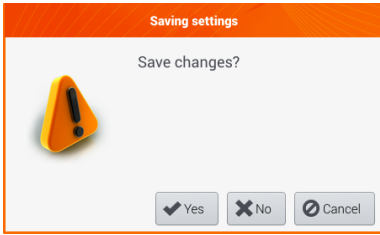

Description of function icons

- ◀ return to the previous screen. After touching the icon you may be prompted to save or reject changes:
Yes – accept selection,
No – reject changes,
Cancel – cancel the action
- 💾 saving changes
- 🏠 returning to the main menu

2.2.2 Sub-menu Edit fuses

On the **Fuse base** screen the following parameters of circuit breakers can be defined and edited:

- manufacturer,
- model (type) of fuse,
- characteristic of fuse.

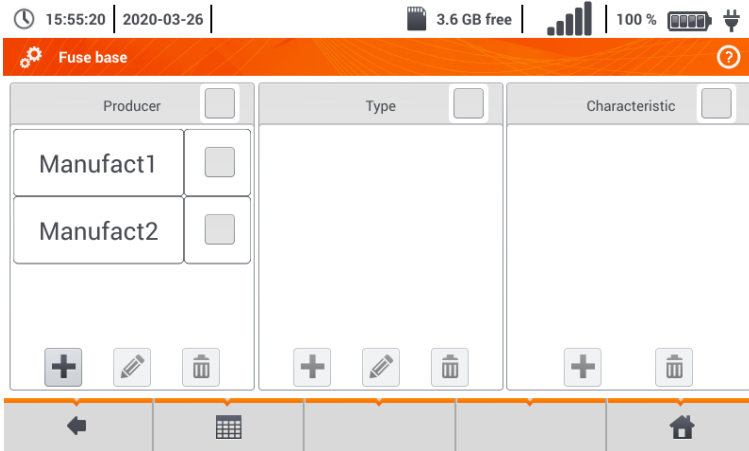

a. Adding fuse characteristics

1

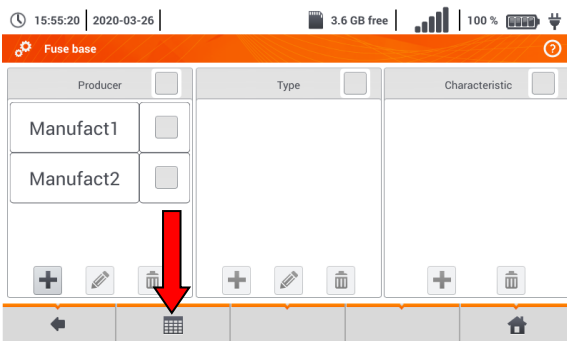

- Select the  icon.
- A menu will appear for adding time-current characteristics of fuses.

2



Available options

- adding characteristics for the selected fuse rated current.
- removing characteristics for the selected fuse rated current.
- pasting the set value for records in the whole row or table.

Description of function icons

- inactive characteristic
- active characteristic
- adding a new characteristic
- editing the name of the active characteristic
- removing the active characteristic
- returning to the previous screen
- going to the main menu

3

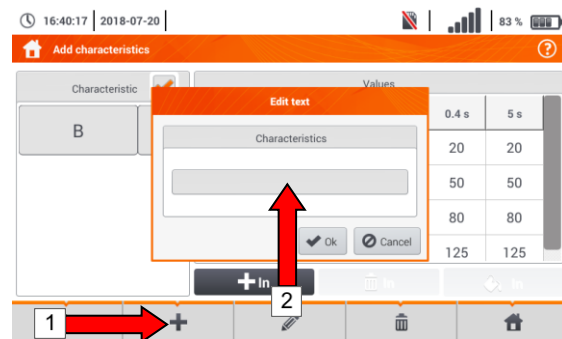

To create a new characteristic:

- select the icon,
- touch the name selection field.

4

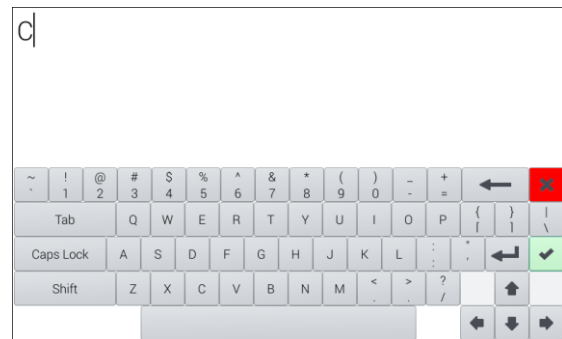

Enter the name from the touch keypad (holding certain buttons for a longer time triggers Polish characters).

Functions of icons

- rejecting changes and returning to step 3
- accepting changes and going to step 5

5

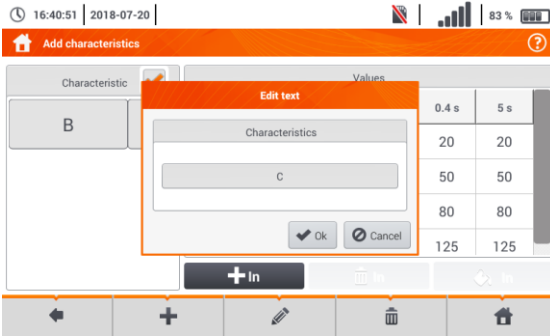



Description of function icons

Ok – accept the name

Cancel – cancel the action

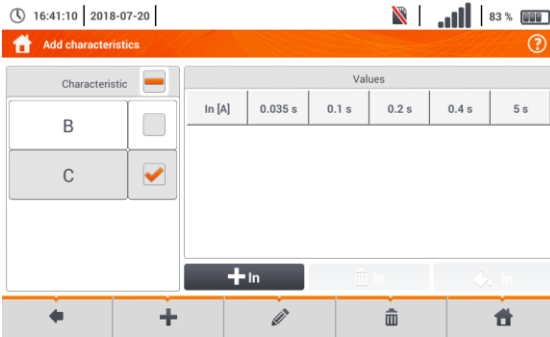
6



• Activate the created characteristic .

• Add rated fuse current using icon .

• Editing fuse data proceed as in steps [3](#) [4](#) [5](#).

7

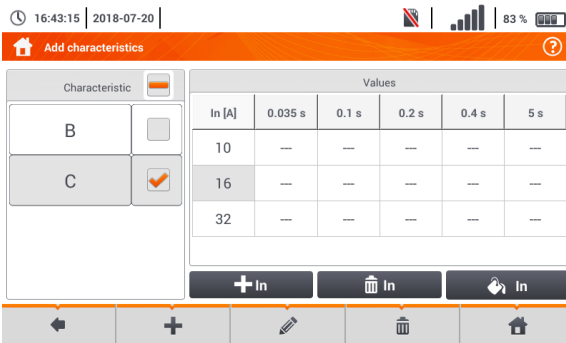

• To activate a row of data, select any item in the row.

• Icons   will be activated.

8

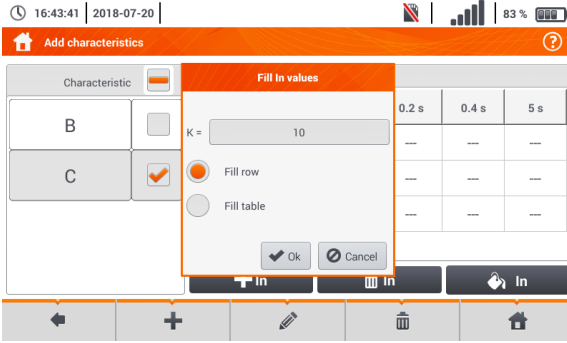

After selecting , the following options are available:

- ⇒ **parameter K** – setting the multiplication factor of fuse rated current (parameter of the time-current characteristic),
- ⇒ **fill row** – copying K value to the selected row,
- ⇒ **fill table** – copying K value to all records.

- Touch the K parameter edit field.
- Enter the parameter values as in step 4.

Description of function icons

Ok – accept selection
Cancel – cancel changes

9

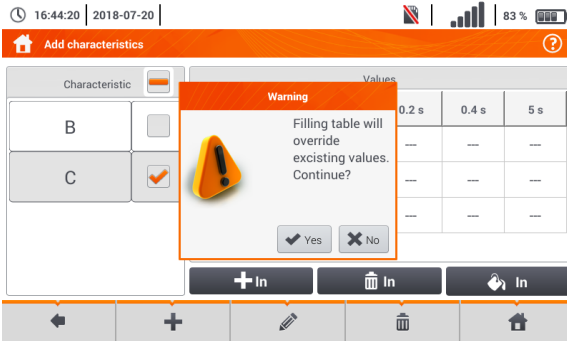

You will be prompted to conform the selection.

Description of function icons

Yes – accept selection
No – reject changes

10

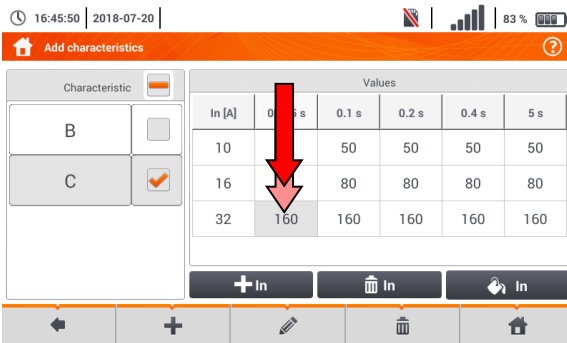

To change the contents of a selected cell, touch it **twice**.

11



On-screen keyboard will appear. Delete the existing entry and enter the required one.

Functions of icons

- ✖ reject changes and return to the menu for adding characteristics
- ✔ accept changes and return to the menu for adding characteristics

12

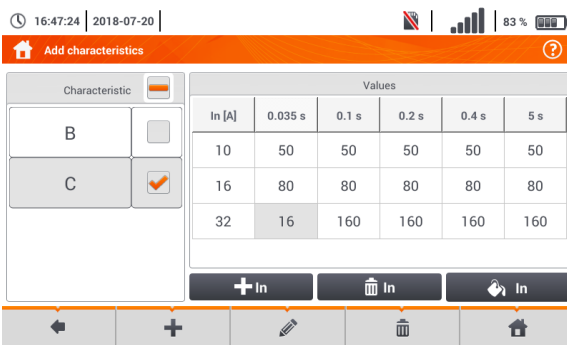

Select the ← icon and return to the fuse base menu.

b. Adding fuses

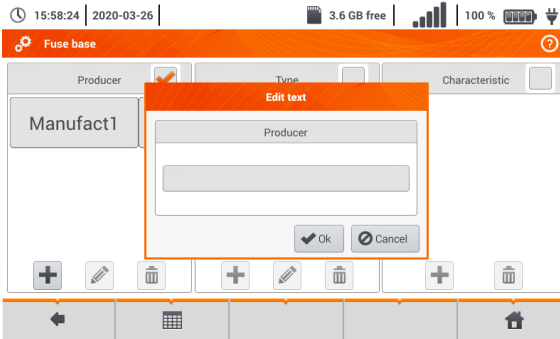

①



Add a producer.

- In **Producer** column press **+**.
- Touch the name input field.
- Enter the name from the touch keypad (holding certain buttons for a longer time triggers additional characters).

Functions of icons

-  reject the changes
-  accept changes and go to step

②

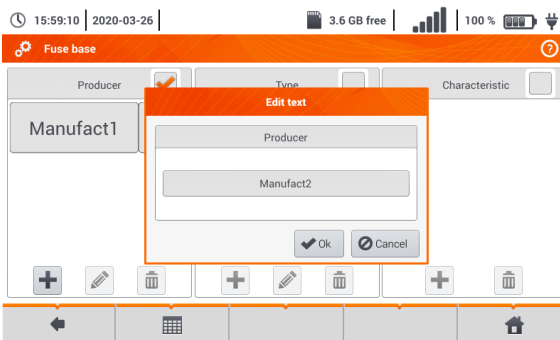

2

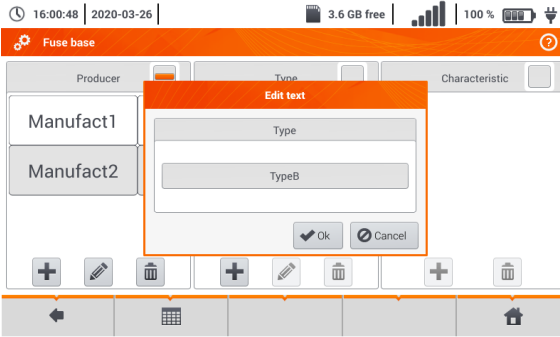

- Select the producer.
- In **Type** column press **+**.
- Enter the fuse model as in step ①.

3

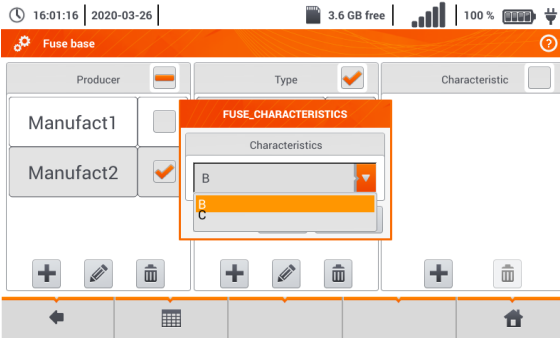

- Highlight the required type of fuse.
- In the **Characteristic** column press **+**.
- Enter the fuse characteristic from list.

4

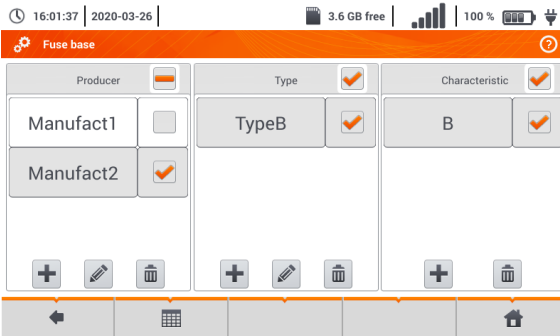

Description of function icons

- record inactive
- record active
- +** add new record
- edit active record name
- remove active record
- return to the previous screen
- return to the main menu

2.2.3 MPI-540-PV Sub-menu PV modules

1

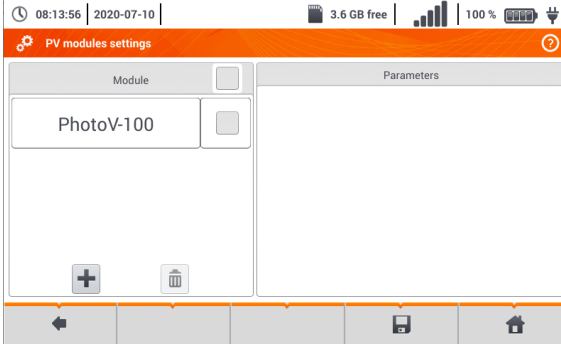

- In **Module** column, use **+** icon to add PV module.
- In **Parameters** column, complete the module parameters.

2

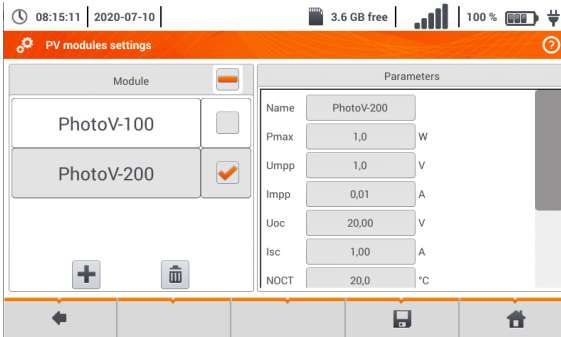

Description of function icons

- record inactive
- record active
- +** add new record
- edit active record name
- remove active record
- return to the previous screen
- return to the main menu

List of parameters

- Name** – name of the module
- Pmax** – power in MPP point*
- Umpp** – voltage in MPP point*
- Impp** – current in MPP point*
- Uoc** – open circuit voltage
- Isc** – short-circuit current
- NOCT** – nominal operation cells temperature
- alpha** – temperature current coefficient - Isc
- beta** – temperature voltage coefficient - Uoc
- gamma** – temperature power coefficient - Pmax
- Rs** - serial resistance of PV module

* MPP – maximum power point

2.3 Communication

2.3.1 USB communication

The B-type USB port built-in in the meter is used to connect the meter to the computer in order to download the data stored in its memory. The data may be downloaded and read through the software provided by the manufacturer.

- **Sonel Analysis** – the software provides support for the meter's recorder all PQM series analysers. It enables data reading from the recorder and data analysis.
- **Sonel Reader** – the software is used to retrieve the data saved from the meter memory. In addition, it enables data transfer to the PC, data saving in popular formats and printing.
- **Sonel Reports PLUS** – supports creation of documentation after testing of electrical installation. Software communicates with Sonel test instruments, download data from memory of test instrument and creates necessary documentation.

Detailed information is available from the manufacturer and distributors.

- 1 Connect the cable to the USB port of the computer and the USB slot of the meter.
- 2 Start the program.



Current versions of software may be found at the manufacturer's website.

2.3.2 Connection to a Wi-Fi network

- 1 Go to **Settings** ► **Communication settings** ► **Wi-Fi**.
- 2 Turn on Wi-Fi (the Wi-Fi status icon  should appear in the top bar).
- 3 Select a network with Internet access from the list. Touch it twice and - if it is password-protected - enter the password. To log out of the network, also tap it twice.
- 4 Select **Ok** and check that the meter is connected to the network. The Wi-Fi status icon will then indicate the signal strength.

2.3.3 **MPI-540-PV** Connection with an irradiance meter

- 1 Go to **Settings** ► **Communication settings** ► **LoRa**.
- 2 Connect the LoRa adapter to the USB socket of the meter. The **LoRa** symbol will appear on the top bar.
- 3 Set the irradiance meter into the pairing mode. Enter its serial number to MPI-540-PV.
- 4 Select **Pair**.

2.3.4 E-mail settings

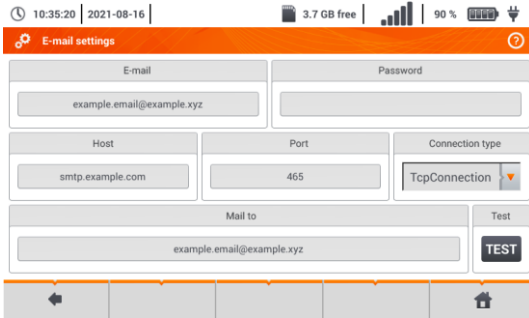

- Go to **Settings ► Communication settings ► E-mail settings**.

- Fill the fields on the screen: parameters of the outgoing mailbox address.

- Press **TEST** to send a test email.



The function works with selected email providers. The list of suppliers is available on the manufacturer's website.

2.4 Software update



NOTE!

- Before you proceed to software update, charge the accumulators.
- Do not switch off the meter while updating.

2.4.1 Update via USB

- 1 The update file can be downloaded from the manufacturer's website.
- 2 Save the file to a USB drive. The memory must have the FAT32 file system.
- 3 Select **Settings ► Software update** to open the update menu.

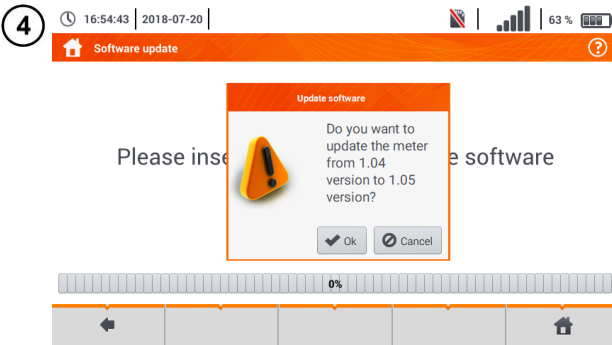

- Insert the USB memory in the Type A USB port in the meter. The information screen will appear.

- To start the update process, select **Ok** in the information window.



Alternatively, you can press the **Update via Wi-Fi** button. Then follow the procedure described in **sec. 2.4.2**.

2.4.2 Update via Wi-Fi

- 1 Connect to the Wi-Fi network according to **sec. 2.3.2**.
- 2 Choose one of the following.
 - Go to **Settings ► Software update** and select **Update via Wi-Fi**.
 - Restart the meter.
- 3 The device will automatically check if a software update is available. If it is, a window is displayed asking the user to accept the update.
- 4 To start the update process, select **Ok** in the information window.



Security features inside some networks may prevent the meter from being able to connect to the manufacturer's server with updates – then the following message will be displayed:
Unable to update Wi-Fi...

2.5 Regional settings

- 1 
 - Select **Settings ► Regional** to open the language settings menu.
 - Expand the list of languages to select from.
 - Select the required language.

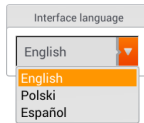

Description of function icons

 return to the previous screen (you may be prompted to save or reject changes)

 saving changes

 returning to the main menu

- 2  If the changes have not been saved or the  icon was selected, a prompt will appear to confirm the selection.

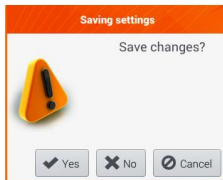

Description of function icons

Yes – accept selection

No – reject selection

Cancel – cancel the action

2.6 Meter information

1 09:50:16 | 2018-11-15 | 3.7 GB | 93% | Select **Meter info** in the main menu.

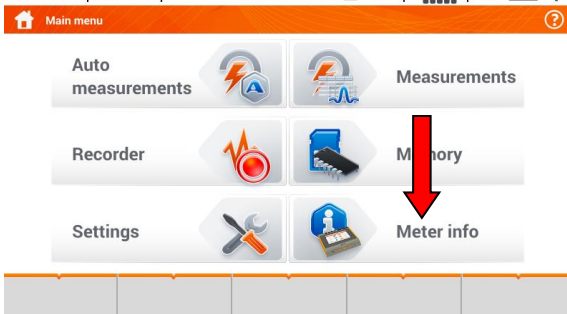

2 09:50:09 | 2018-07-21 | 54% | The menu contains information on the manufacturer and the meter.

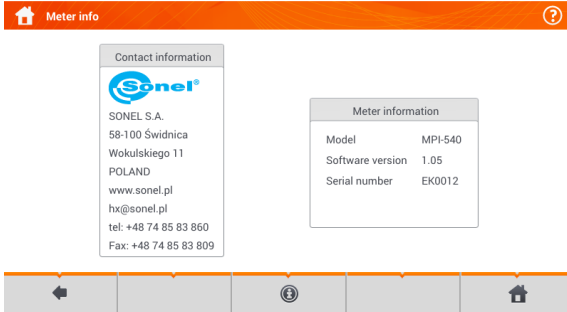

Description of function icons

← return to the previous screen (you may be prompted to save or reject changes)

ⓘ display detailed information

🏠 return to the main menu

3 09:50:25 | 2018-07-21 | 56% | The screen after selecting icon ⓘ.

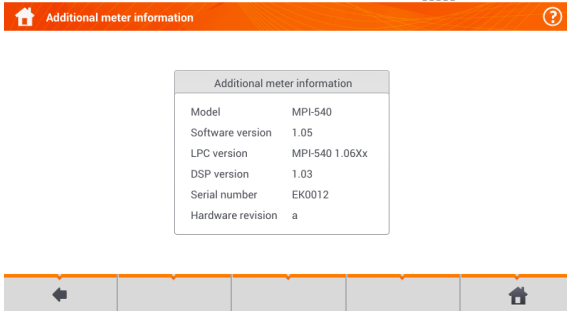

3 Measurements

The following tests are available from the **Measurements** menu.



Low voltage measurements - LV:

- fault loop impedance (Z_{L-N} , Z_{L-L} , Z_{L-PE} , $Z_{L-PE[RCD]}$ with RCD),
- voltage drop ΔU ,
- insulation resistance R_{ISO} ,
- checking the parameters of RCD (tripping current **RCD** I_A , tripping time **RCD** t_A and automatic measurements),
- resistance R_X ,
- continuity of connections R_{CONT} ,
- phase sequence **1-2-3**,
- direction of motor rotations **U-V-W**,
- resistance-to-earth R_E ,
- soil resistivity Ωm ,
- illuminance **Lux**.

MPI-540-PV



Measurements of photovoltaic devices - PV:

- continuity of protective conductors and equipotential bonding R_{CONT} ,
- resistance-to-earth R_E ,
- insulation resistance R_{ISO} **PV**,
- open circuit voltage U_{OC} ,
- short circuit current I_{SC} ,
- currents and powers on AC and DC side of the inverter and its efficiency η , **P**, **I**,
- irradiance **Irr**.



WARNING

During measurements (fault loop, RCD), do not touch conductive accessible or foreign parts of the tested electrical installation.



- The content of this chapter should be thoroughly familiarized with. It describes the **meter circuits**, the **methods of measurements** and basic principles concerning **interpretation of measurement results**.
- A progress bar is displayed during long measurements.
- The result of the last measurement is displayed until: next measurement starts, measurement parameters are changed, measurement function is changed, the meter is switched off.
- The last measurement can be recalled using the  icon.

3.1 Diagnostics performed by the meter – limits

The meter is able to assess whether the measurement result is within acceptable limits for the selected safety device or the limit value. The user may set a limit, the threshold value which should not be exceeded by the result. It is possible for all measurement functions except for:

- RCD measurements (I_A , t_A) for which the limits are permanently enabled,
- fault loop measurements, where the limit is determined indirectly by selecting a suitable overcurrent protection for which standard limits are assigned,
- the recorder.

For the measurements of insulation resistance and light the limit is the **minimum** value. For measurements of fault loop impedance, earth resistance, resistance of protective conductors and equipotential bonding - it is the **maximum** value.

The limits are set in the relevant measurement menu. After each measurement the meter displays the symbols:



the result is within the set limits,



the result is outside the set limits,



assessment of the result correctness not possible. The symbol is displayed, when for example the result is not available (e.g. measurement in progress, or no measurement has been performed)

the method for setting limits is described in the sections describing the measurement data.

3.2 Measurement of alternating voltage and frequency

The meter measures and displays alternating voltage and network frequency in the selected measurement functions in accordance with the table below.

Measuring function	U	f
Z_{L-N}	•	•
Z_{L-PE}	•	•
$Z_{L-PE[RCD]}$	•	•
R_{ISO}	•	
RCD I_A	•	•
RCD t_A	•	•
R_x		
R_{CONT}		
Phase sequence	•	
Motor rotation	•	
Resistance-to-earth R_E	•	
Soil resistivity	•	
Illuminance		
Recorder	•	•

3.3 Checking the correctness of PE (protective earth) connections

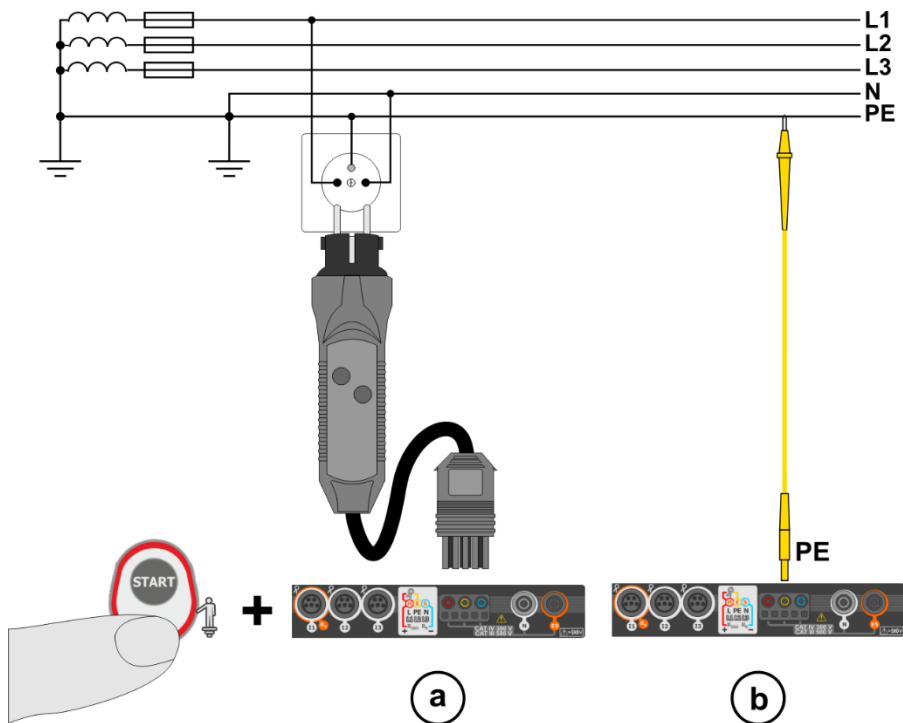

When the meter is connected as in the drawing, touch the contact electrode and wait for about **1 second**. If voltage is detected on the PE conductor, the device:

- will display text **PE!** (installation error, the PE lead connected to the phase conductor) and
- will generate a continuous audio signal

This option is available for all measuring functions that apply to residual current devices (RCD) and fault loop **except Z_{L-N} , $L-L$ measurement**.



WARNING

When phase voltage is detected on PE lead, measurements must be immediately stopped and a fault in the installation must be removed.



- Make sure to stand on non-insulated ground when measuring. Insulated ground may cause an incorrect test result.
- If the voltage on the PE conductor exceeds the acceptable limit value (approx 50 V), the meter will signal the fact.
- If the IT network has been selected in **section 2.2.1** step **①**, the contact electrode is **inactive**.

3.4 Fault loop parameters



NOTE!

- If there are residual current devices in the network tested, they should be bypassed by bridging for the period of impedance measurement. However, it should be remembered that the tested circuit is modified in this way and the obtained results may slightly differ from the actual results.
- After completing measurements, always remove modifications introduced to the tested system for the period of measurements and check the operation of the residual current switch.
- The above remarks **do not apply** to measurements of fault loop impedance with the use of function $Z_{L-PE[RCD]}$.
- Measurements of short-circuit loop impedance **downstream the inverters** are **ineffective** and measurement results **unreliable**. This is due to the fluctuations of internal impedance of the inverter during its operations. Do not perform measurements of short-circuit loop impedance directly downstream inverters.

3.4.1 Settings of measurements

1



Select item $Z_{L-N, L-L}$, Z_{L-PE} or $Z_{L-PE[RCD]}$.

2

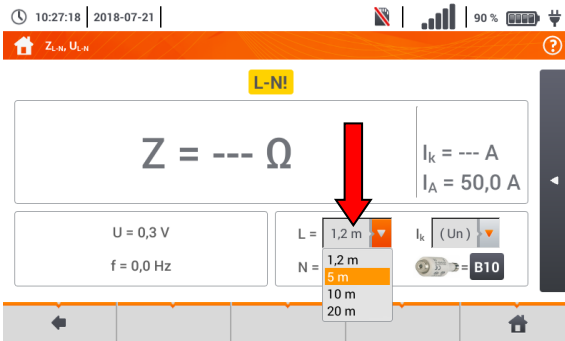

The correctness of the measurement depends on the correct adjustment of the length of leads.

If a **WS type adapter** has not been connected to the meter, standard manufacturer's lead lengths are available in the menu.

- In this case, touch the drop-down list field.
- Select the required lead length.

3

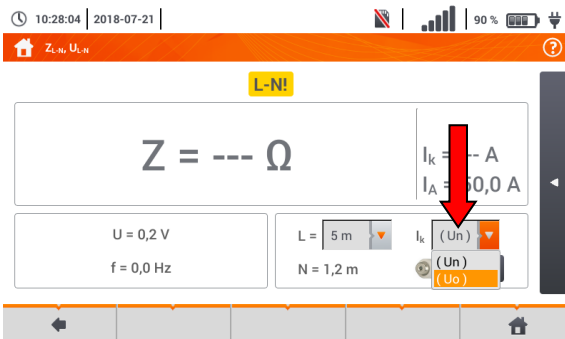

The prospective short-circuit current I_k can be calculated based on one of two values:

- ⇒ rated network voltage U_n ,
- ⇒ voltage measured by the meter U_0 .

The physical meaning of the parameter is presented in **section 3.4.5**.

- Touch the drop-down list field.
- Select the required value.

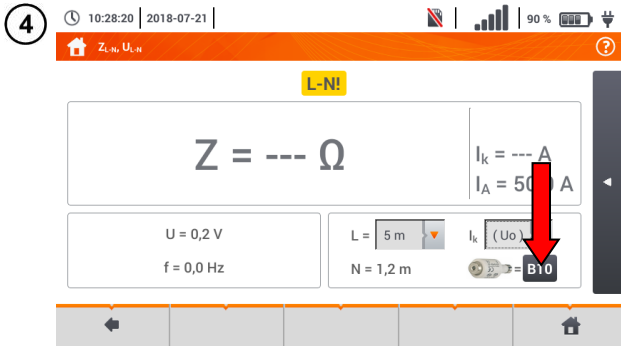

The result can be compared against the acceptable fault loop impedance Z_{sdop} , determined on the basis of the fuse parameters of the tested circuit:

- ⇒ characteristic,
- ⇒ rated current.

- Touch the fuse type field.

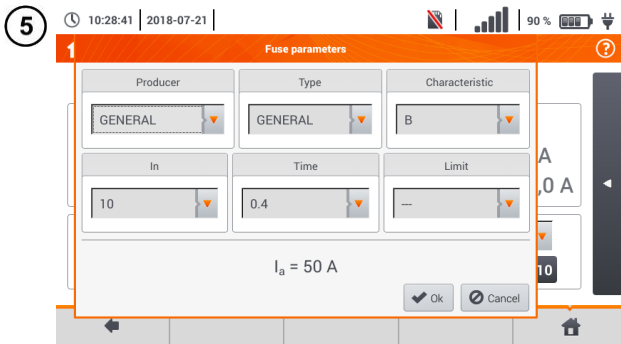

Options to select:

- **Manufacturer**
 - ⇒ GENERAL – no defined manufacturer
 - ⇒ manufacturers defined in the meter memory (**section 2.2.2**)
- **Type**
 - ⇒ GENERAL – no defined type
 - ⇒ types defined in the meter memory (**section 2.2.2**)
- **Time-current characteristic**
- **Rated current I_N**
- **Acceptable response time**
- **Limit** – the limit resulting from standard EN 60364-6
 - ⇒ --- I_a as in the standard tables – no correction
 - ⇒ **2/3Z** – I_a is increased by the value of $0.5I_a$

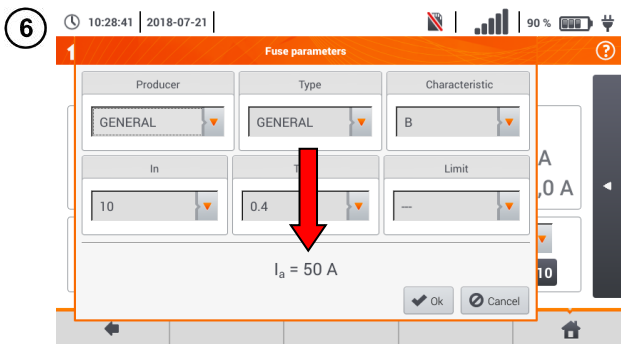

The current is calculated after setting parameters in steps (6) (7). I_a – current ensuring automatic triggering of a protective device within a required time.

Description of function icons

- Ok** – accept fuse settings
- Cancel** – cancel the action

3.4.2 Fault loop parameters in the L-N and L-L circuits

- 1 Connect test leads according to the drawing
 (a) or (b) for measurement in the L-N circuit,
 (c) for measurement in the L-L circuit.

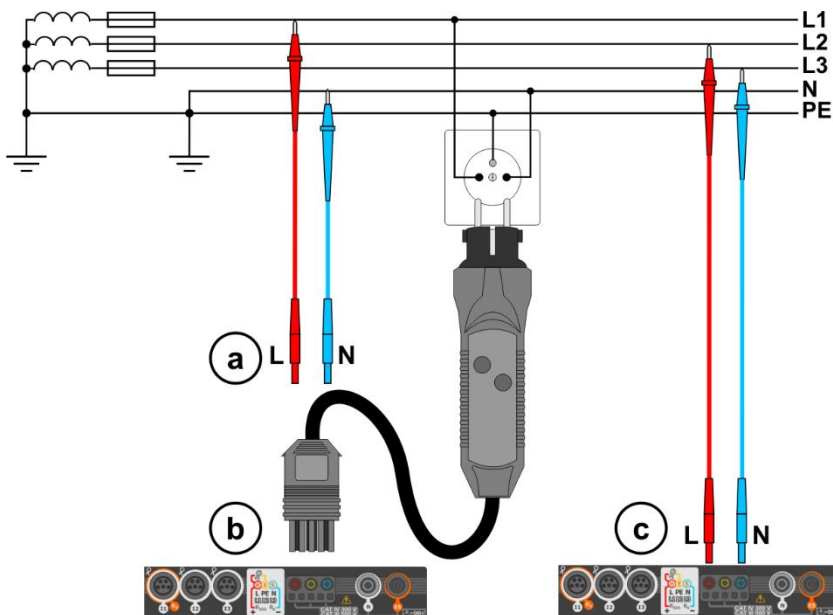

2



Select item $Z_{L-N, L-L}$.

3

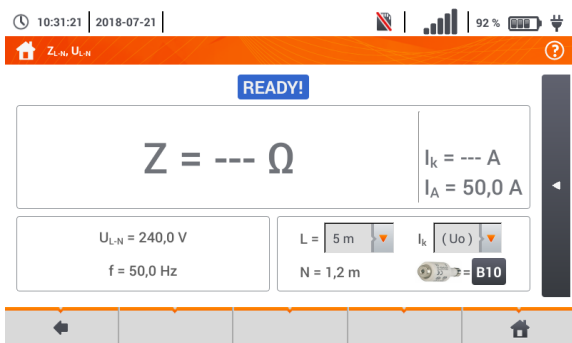

The measurement screen will appear.

Live mode

U_{L-N} – current voltage between phase and neutral conductors
 f – current frequency on the tested object

4

Enter the measurement settings in accordance with **section 3.4.1**.

5



Press **START** to perform measurement.

6

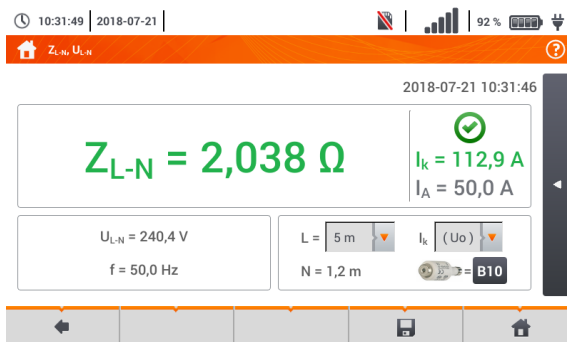

Read out the result.

Z_{L-N} – the main result
I_k – prospective short-circuit current with signalling the fulfilment of the acceptable loop criterion (section 3.4.1, step 6):

- met
- not met
- assessment not possible

I_A – current ensuring automatic triggering of a selected protective device within a required time

After selecting the bar on the right side, a menu will show with additional measurement results.

7

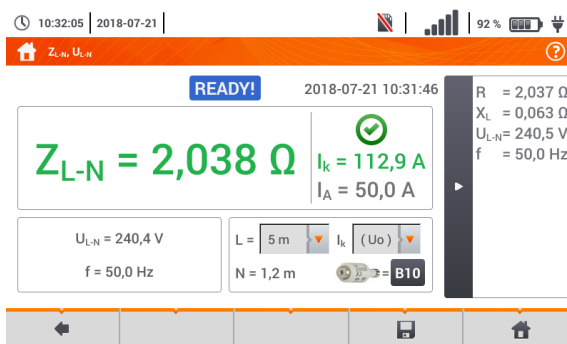

R – resistance of the tested circuit
X_L – reactance of the tested circuit
U_{L-N} – voltage relative to the neutral conductor

f – frequency
Selecting the bar hides the menu.

8

Save the measurement to the meter memory using the icon. A detailed description of memory management is contained in section 6.1.3.

The last measurement can be recalled using the icon.



- When many measurements are performed in short time intervals, the meter may emit a large amount of heat. As a result of this, the housing of the device may become hot. This is **normal**. In addition, the meter is equipped with the protection against excessive temperature.
- After approx. 15 consecutive measurements of the fault loop wait until the instrument cools down. This limitation is due to the high current measurement and multifunctionality of the meter.
- Minimum **interval** between successive measurements is **5 seconds**. The displayed message **READY!** indicates that it is possible to perform another measurement. Until the message is displayed, the meter prevents any measurements.

Additional information displayed by the meter

READY!	The meter is ready for measurement.
IN PROGRESS	Measurement in progress.
L-N!	U_{L-N} voltage is incorrect for making a measurement.
L-PE!	U_{L-PE} voltage is incorrect for making a measurement.
N-PE!	U_{N-PE} voltage exceeds allowable value of 50 V.
L ↔ N	Phase connected to N terminal instead of L terminal (for example, exchange of L and N in the mains socket).
TEMPERATURE!	Maximum temperature inside the meter is exceeded.
f!	Network frequency is outside the range of 45...65 Hz.
ERROR!	Error during the measurement. Correct result cannot be displayed.
Loop circuit malfunction!	The meter should be serviced.
U>500V! and continuous audio signal	Before measurement, voltage at test terminals exceeds 500 V.
VOLTAGE!	The voltage on the tested object is not within the limits specified for the set rated voltage of the network U_n (section 2.2.1 step ①).
LIMIT!	Too low value of the prospective short circuit current I_k for the pre-set fuse and time of its triggering.

3.4.3 Fault loop parameters in the L-PE circuit

- 1 Connect test leads according to Fig. 3.1 or Fig. 3.2.

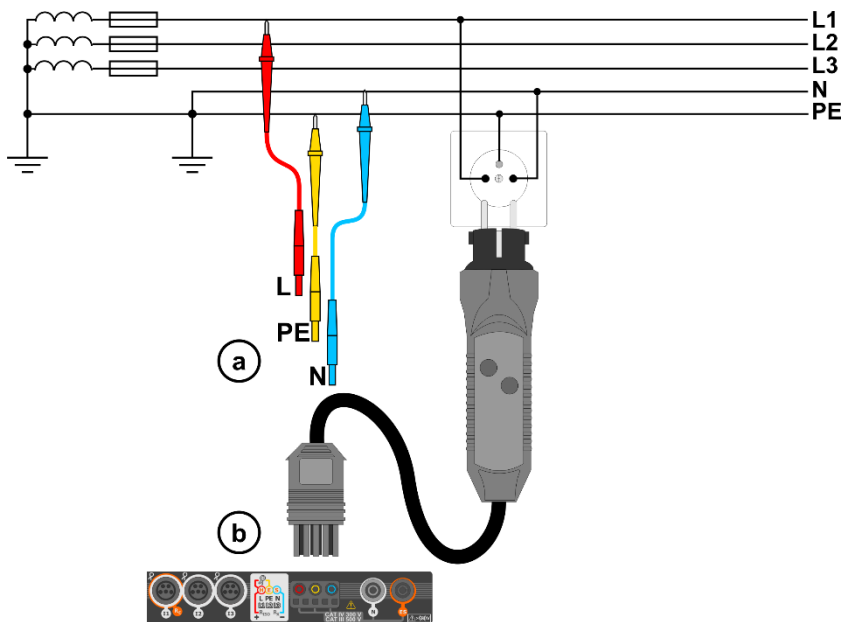

Fig. 3.1 Measurement in L-PE circuit

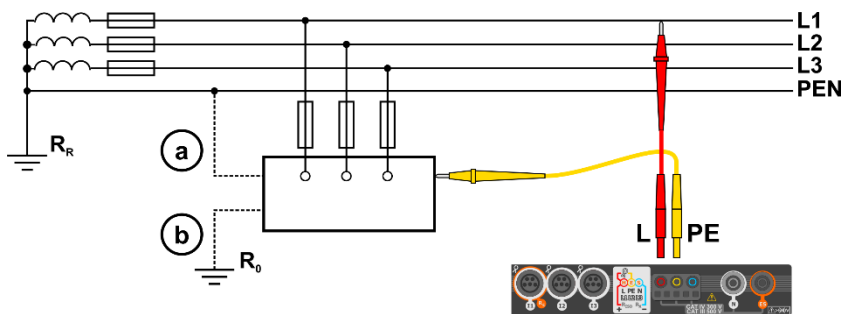

Fig. 3.2 Checking effectiveness of protection against electric shock of the meter housing in case of: **a** TN network or **b** TT network

2



Select item **Z_{L-PE}**.

3

10:48:58 | 2018-07-21 |



The measurement screen will appear.

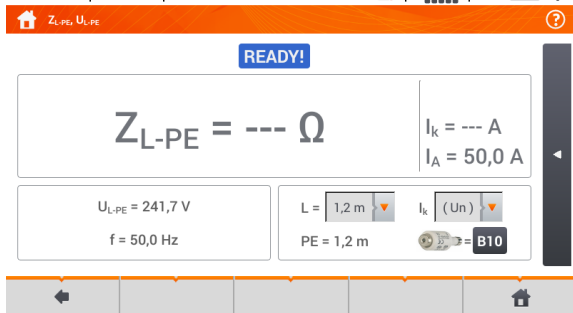

Live mode

U_{L-PE} – current voltage between phase and protective conductors
f – current frequency on the tested object

4

Enter the measurement settings in accordance with **section 3.4.1**.

5



Press the **START** button to perform measurement.

6

10:49:26 | 2018-07-21 |



Read out the result.

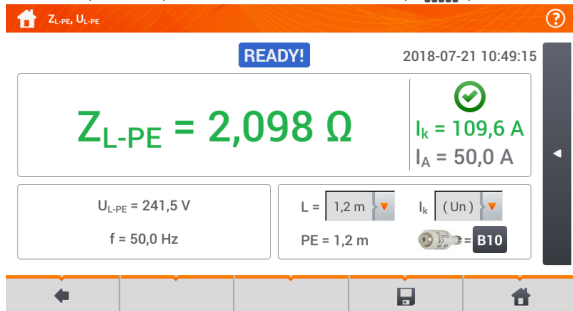

Z_{L-PE} – the main result

I_k – prospective short-circuit current with signalling the fulfilment of the acceptable loop **criterion** (**section 3.4.1**, step 6):

- met
- not met
- assessment not possible

I_a – current ensuring automatic triggering of a selected protective device within a required time

After selecting the bar on the right side, a menu will slide out with additional measurement results.

7

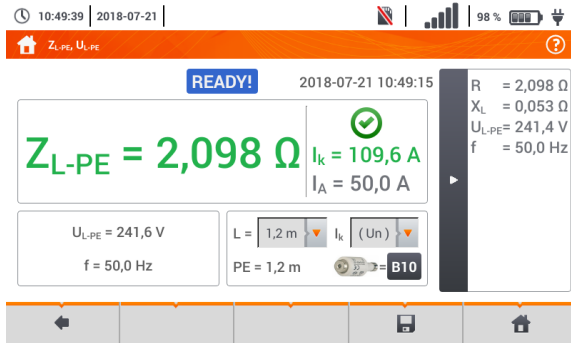

R – resistance of the tested circuit
X_L – reactance of the tested circuit
U_{L-PE} – voltage relative to the protective conductor
f – frequency

Selecting the bar hides the menu.

8

Save the measurement to the meter memory using the icon. A detailed description of memory management is contained in **section 6.1.3**. The last measurement can be recalled using the icon.



- Double-lead measurement is not available for the UNI-Schuko adapter.
- When many measurements are performed in short time intervals, the meter may emit a large amount of heat. As a result of this, the housing of the device may become hot. This is **normal**. In addition, the meter is equipped with the protection against excessive temperature.
- After approx. 15 consecutive measurements of the fault loop wait until the instrument cools down. This limitation is due to the high current measurement and multifunctionality of the meter.
- Minimum **interval** between successive measurements is **5 seconds**. The displayed message **READY!** indicates that it is possible to perform another measurement. Until the message is displayed, the meter prevents any measurements.

3.4.4 Fault loop impedance in L-PE circuit protected with a residual current device (RCD)

- 1 Connect test leads according to Fig. 3.3 , Fig. 3.4 or Fig. 3.5.

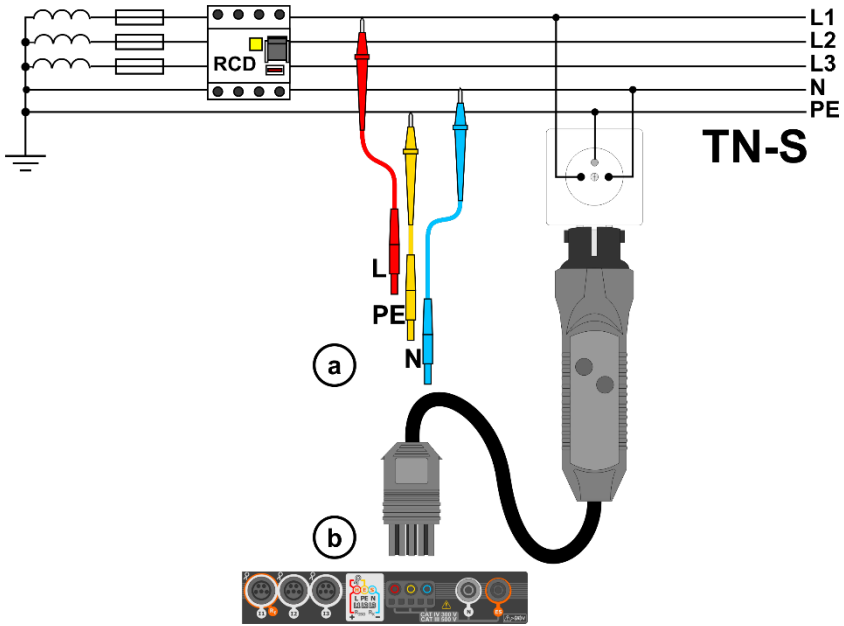

Fig. 3.3 Measurement in the TN-S system

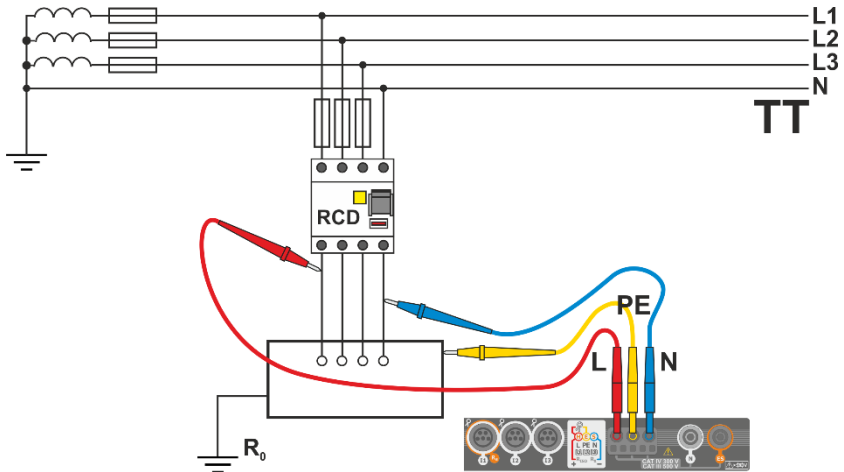

Fig. 3.4 Measurement in the TT system

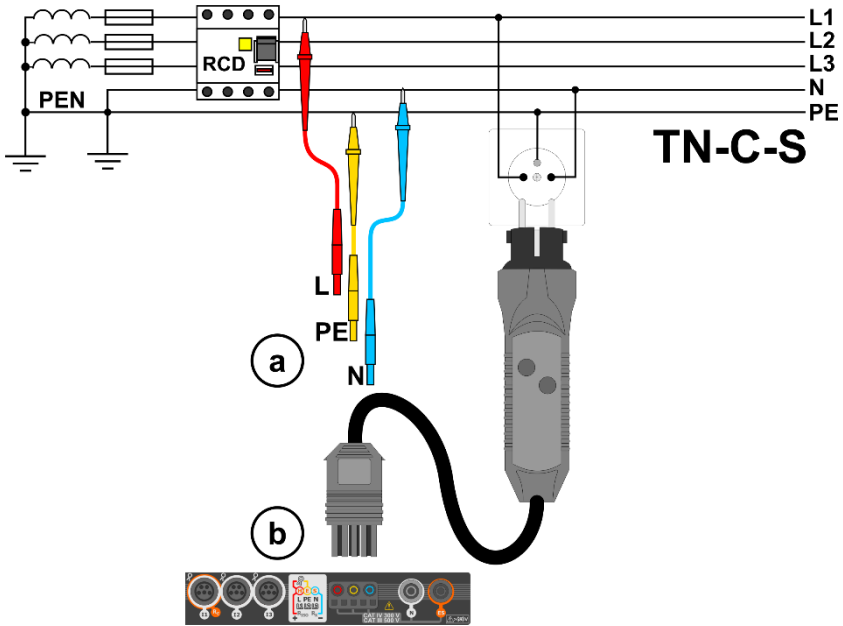

Fig. 3.5 Measurement in the TN-C-S system

2



Select item $Z_{L-PE[RCD]}$.

3

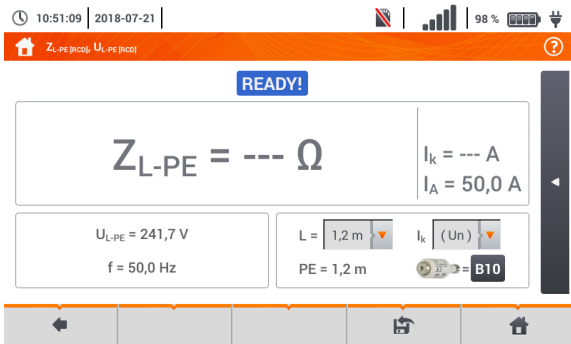

The measurement screen will appear.

Live mode

U_{L-PE} – current voltage between phase and protective conductors
 f – current frequency on the tested object

4

Enter the measurement settings in accordance with **section 3.4.1**.

5



Press the **START** button to perform measurement.

6

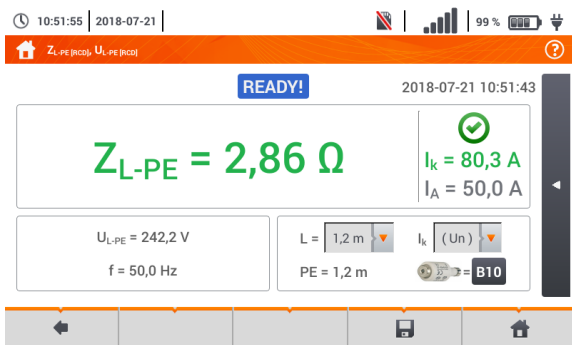

Read out the result.

Z_{L-PE} – the main result
 I_k – prospective short-circuit current with signalling the fulfilment of the acceptable loop criterion (section 3.4.1, step 6):

- met
- not met
- assessment not possible

I_a – current ensuring automatic triggering of a selected protective device within a required time

After selecting the bar on the right side, a menu will slide out with additional measurement results.

R – resistance of the tested circuit
 X_L – reactance of the tested circuit
 U_{L-PE} – voltage relative to the protective conductor
 f – frequency

Selecting the bar hides the menu.

7

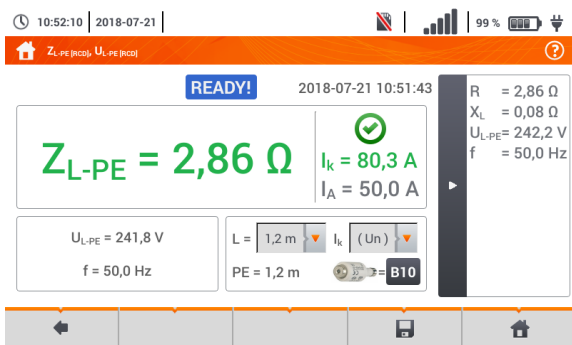

$R = 2,86 \Omega$
 $X_L = 0,08 \Omega$
 $U_{L-PE} = 242,2 V$
 $f = 50,0 Hz$

8

Save the measurement to the meter memory using the icon. A detailed description of memory management is contained in section 6.1.3. The last measurement can be recalled using the icon.



- Maximum measurement time is few seconds. The measurement can be interrupted by pressing the button.
- In the electrical installations with 30 mA RCD's, the sum of leakage currents of the installation and the test current may trigger the RCD. If this happens, try to reduce the leakage current in the tested mains (for example by disconnecting loads).
- The function works for residual current devices of rated current ≥ 30 mA.
- When many measurements are performed in short time intervals, the meter may emit a large amount of heat. As a result of this, the housing of the device may become hot. This is **normal**. In addition, the meter is equipped with the protection against excessive temperature.
- After approx. 15 consecutive measurements of the fault loop wait until the instrument cools down. This limitation is due to the high current measurement and multi-functionality of the meter.
- Minimum **interval** between successive measurements is **5 seconds**. The displayed message **READY!** indicates that it is possible to perform another measurement. Until the message is displayed, the meter prevents any measurements.

3.4.5 Prospective short-circuit current

The meter always measures fault loop impedance Z_s and the displayed short-circuit current is calculated according to the following formula:

$$I_k = \frac{U}{Z_s}$$

where:

Z_s – measured impedance,

U – voltage dependent on the network rated voltage settings U_n (section 3.4.1 point ④):

$I_k(U_n)$	$U = U_n$
$I_k(U_0)$	$U = U_0$ for $U_0 < U_n$
	$U = U_n$ for $U_0 \geq U_n$

where:

U_n – nominal voltage of the network,

U_0 – voltage measured by the meter.

On the basis of U_n rated voltage selected (section 2.2.1), the meter automatically recognizes the measurement at phase voltage or phase-to-phase voltage and takes it into account in the calculations.

If the voltage of the network being tested is outside the tolerance range, the meter will not be able to determine a proper rated voltage for the short-circuit current calculation. In such a case, --- will be displayed instead of short-circuit current value. Fig. 3.6 shows voltage ranges for which short-circuit current value is calculated.

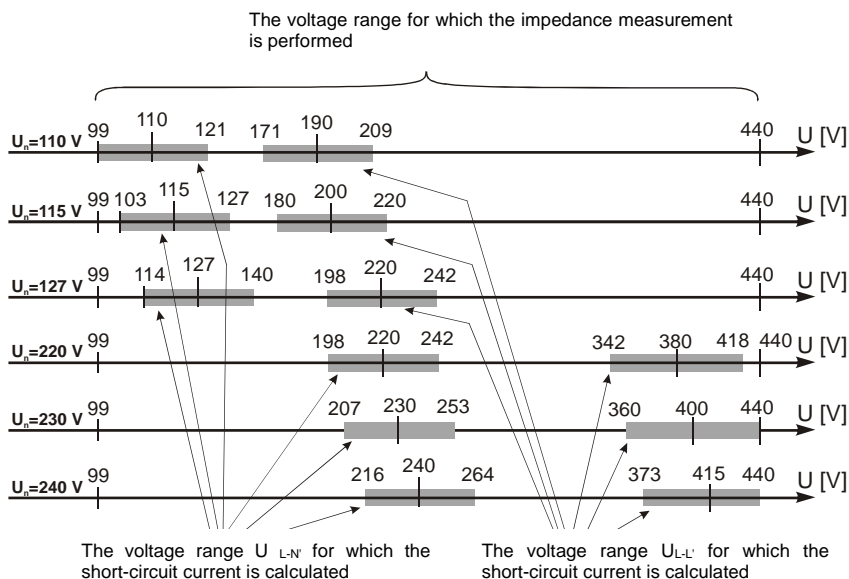

Fig. 3.6 Measuring voltage ranges

3.4.6 Measurement of fault loop impedance in IT networks

Before performing the measurements in the **Measurement settings** menu select the appropriate network type (**section 2.2.1**).



NOTE!

- After selecting an IT type network, the function of the contact electrode is **inactive**.
- When attempting to perform the Z_{L-PE} and $Z_{L-PE[RCD]}$ **measurement** a message will appear informing that the measurement is impossible.

The manner of connecting the device to the installation is shown in **Fig. 3.7**.

The manner of performing the fault loop measurements is described in **section 3.4.2**.

Operating voltage range: **95 V ... 440 V**.

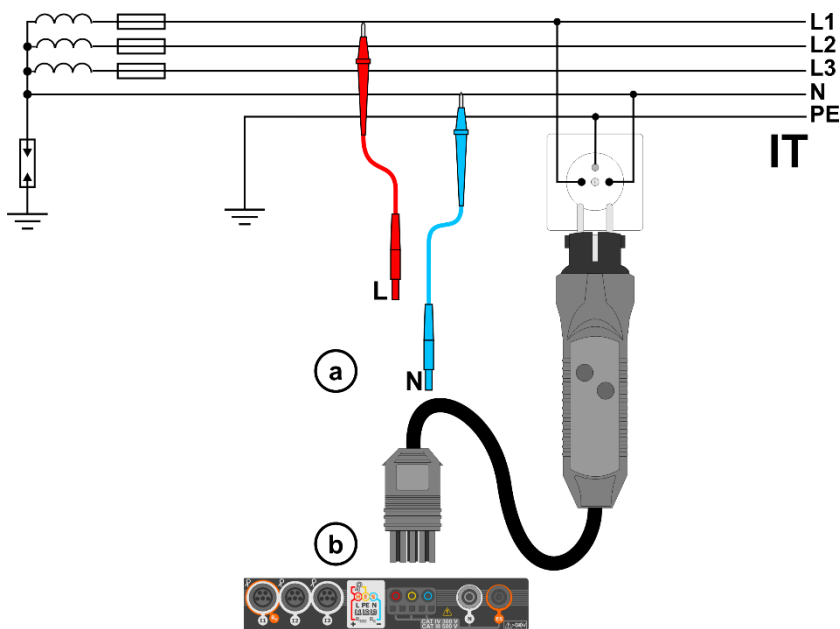
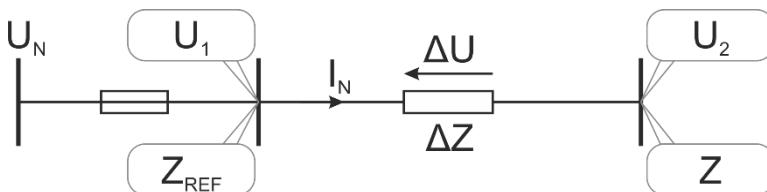

Fig. 3.7 Measurement in the IT system

3.5 Voltage drop

This function determines the voltage drop between two points of the tested network, selected by the user. The test is based on measurement of fault loop impedance L-N at these points. In a standard network, usually the voltage drop is tested between the socket and the switchgear (reference point).



The voltage drop is calculated according to the following formula:

$$\Delta U = \frac{(Z - Z_{REF}) \cdot I_N}{U_N} \cdot 100\%$$

where:

- Z – fault loop impedance at the destination point,
- Z_{REF} – fault loop impedance at the reference point,
- I_N – rated fuse current
- U_N – rated mains voltage.

①

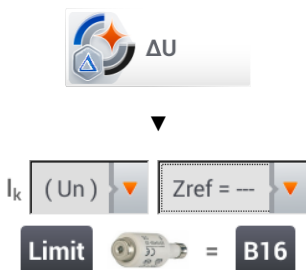

- Select item **ΔU**.
- Use setting **Zref=---** to reset previous measurement, if it has not been done yet.
- Enter the **limit** of voltage drop **ΔU_{MAX}**.
- Enter the **fuse type**, which protects the tested circuit.

②

- Connect the meter to the reference point of the tested network, as for Z_{L-N} measurement
- Press **START**.

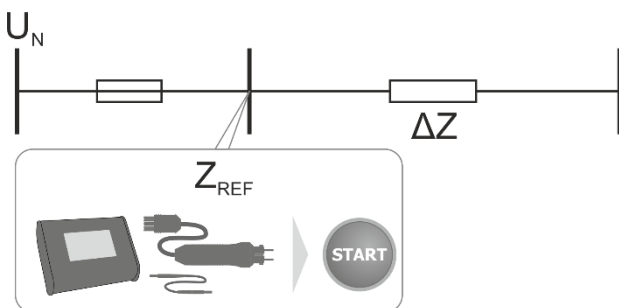

- 3 • Change the setting from **Zref** to **Z**.
- Connect the meter to the reference point, as for Z_{L-N} measurement.
- Press **START**.

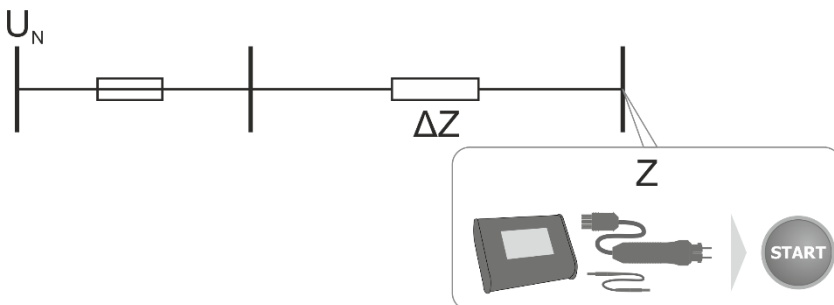

4 15:39:39 | 2020-03-26

3.6 GB free | 100%

Read out the result.

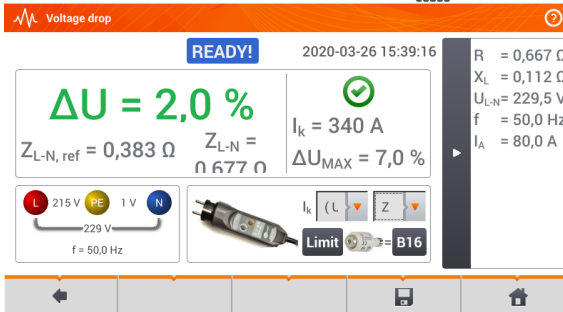

ΔU – the main result and indication of meeting **criterion ΔU_{MAX}** :

- **green:** $\Delta U \leq \Delta U_{MAX}$
- **red:** $\Delta U > \Delta U_{MAX}$

I_k – prospective short-circuit current

After selecting the bar on the right side, a menu will slide out with additional measurement results.

- R** – resistance of the tested circuit
- X_L** – reactance of the tested circuit
- U_{L-N}** – voltage relative to the neutral conductor
- f** – frequency
- I_A** – protection tripping current

Selecting the bar hides the menu.

- 5 Save the measurement to the meter memory using the icon. A detailed description of memory management is contained in **section 6.1.3**. The last measurement can be recalled using the icon.



If Z_{REF} is greater than Z , then the meter indicates $\Delta U = 0\%$

3.6 Resistance-to-earth

3.6.1 Settings of measurements

①



Select item R_E .

②

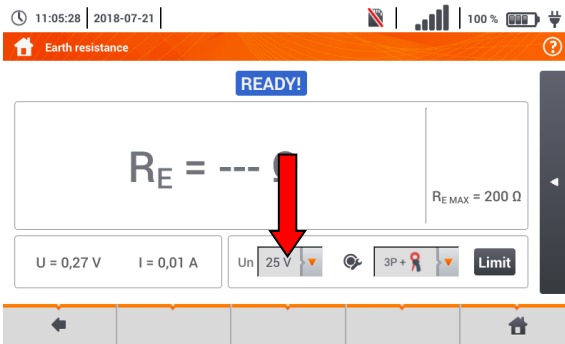

Touch the parameter drop-down menu **Un** (measuring voltage selection).

③



Select the required measuring voltage from the list.

④



Touch the drop-down menu of measurement method selection.

5

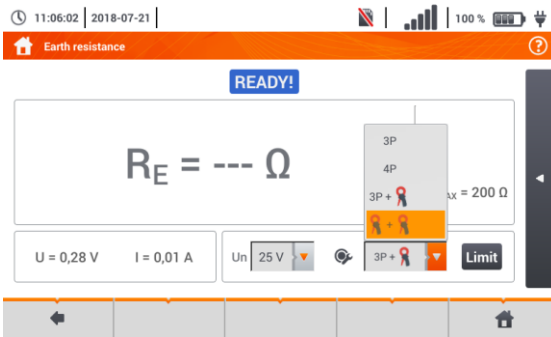

Available measurement methods

- ⇒ 3-wire
- ⇒ 4-wire
- ⇒ 3-wire + receiving clamp
- ⇒ 2-wire (transmitting + receiving clamp)

6

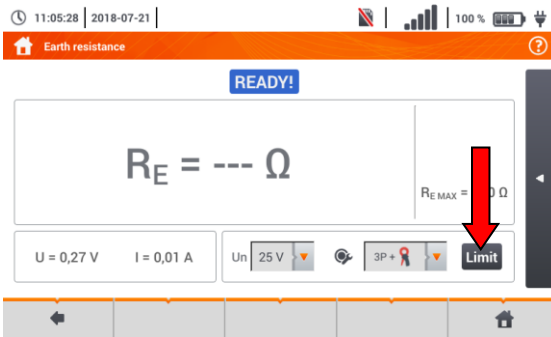

Select **Limit** to set the resistance limit.

7

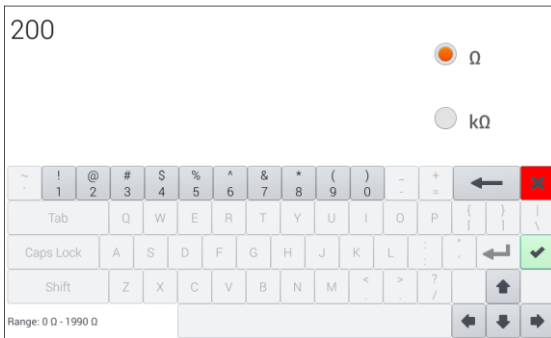

- Select unit.
- Enter the required resistance limit value:
 ⇒ 0.00...1990 for Ω,
 ⇒ 0.00...2 for kΩ.

Functions of icons

- reject changes and exit to the previous screen
- accept changes

3.6.2 Earth resistance measurement with 3-pole method (R_{E3P})

The three-pole measuring method is the basic type of resistance-to-earth measurement.

- 1 Disconnect the tested earth electrode from the installation of the facility.

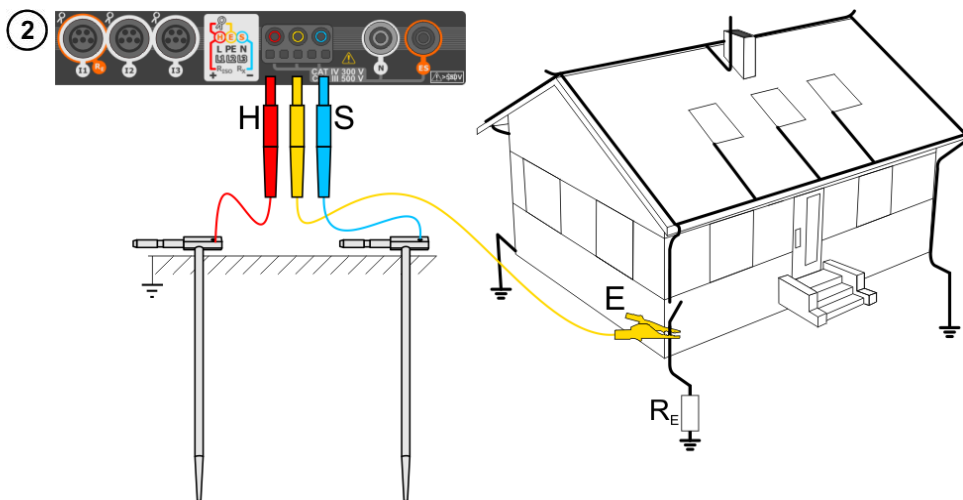
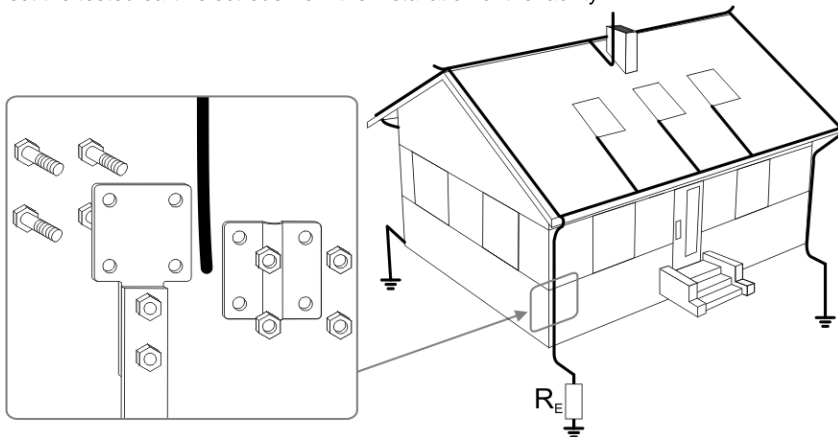

- Drive the **current** electrode into the earth and connect to the **H** socket of the meter.
- Drive the **voltage** electrode into the earth and connect to the **S** socket of the meter.
- The **earth electrode** being tested should be connected to **E** socket of the meter.
- It is recommended that the tested **earth electrode** as well as **H** and **S** electrodes should be located along one line and at relevant distances, in accordance with the rules of earth measurements.

3



- Select the **3P** option in the measurement menu.
- Select other settings in accordance with **section 3.6.1**.

4

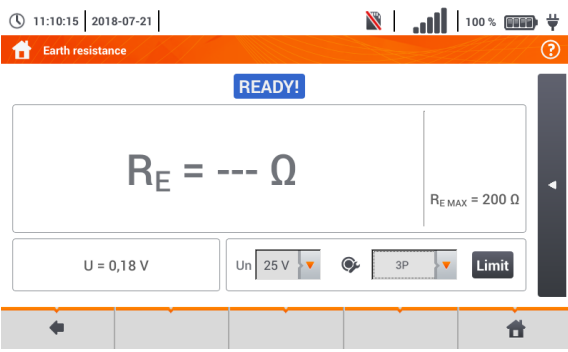

The meter is ready for measurement.

- Live mode
U – interference voltage currently on the object
- Limits
R_{E MAX} – currently set earth resistance limit

5



Press **START** to start the measurement.

6

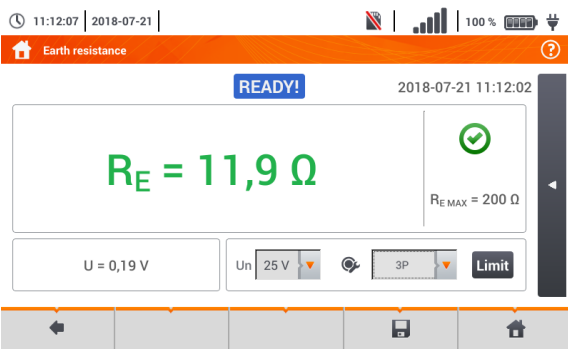

Read out the result.

- Signal lights for reaching the limit (section 3.6.1 step 6)
- ✔ the result is within the set limit
- ✘ the result is outside the set limit
- ⋮ assessment not possible

After selecting the bar ◀ on the right side, a menu will slide out with additional measurement results.

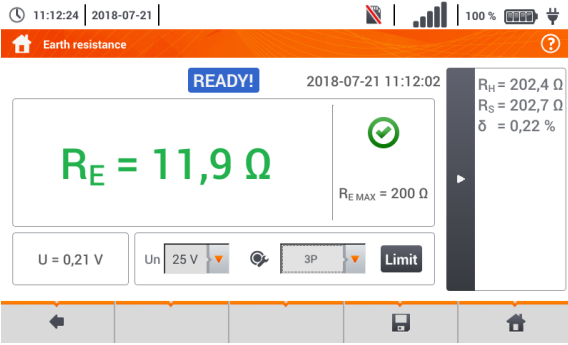

7



R_H – resistance of current electrode
 R_S – resistance of voltage electrode
 δ – additional uncertainty caused by resistance of the electrodes

Selecting the  bar hides the menu.

8

Save the measurement to the meter memory using the  icon. A detailed description of memory management is contained in **section 6.1.3**. The last measurement can be recalled using the  icon.

9

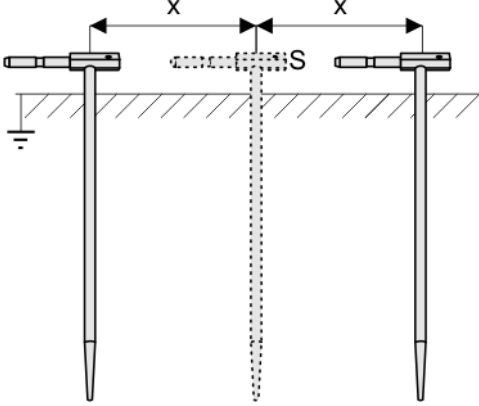

Repeat the steps **2** **5** **6** for two additional locations of the voltage electrode **S**:

- **located at a certain distance** from the tested earth electrode,
- **moved closer** by the same distance to the tested electrode.

This is done to confirm that the **S** electrode was driven into the reference earth. If so, **the difference between the value of R_E between the main measurement and each additional measurement should not exceed 3%**.

If R_E measurement results differ from one another by more than 3%, the distance of the current electrode from the earth electrode being tested **should be considerably increased** and the measurements should be repeated.



WARNING

- **Measurement of resistance-to-earth may be carried out if voltage of interferences does not exceed 24 V. Voltage of interferences is measured up to the level of 100 V.**
- **Over 50 V it is signalled as hazardous. The meter must not be connected to voltages exceeding 100 V.**



- It is recommended that the test **earth electrode** as well as **H** and **S** electrodes should be located in one line. Due to the different field conditions it is not always possible. On the manufacturer's website and in professional literature special cases of probes location have been discussed.
- Particular attention should be paid to quality of connection between the object being tested and the test lead – the contact area must be free from paint, rust, etc.
- If **resistance of test probes is too high**, R_E earth electrode measurement will **include an additional uncertainty**. Particularly high uncertainty of measurement occurs when the tested resistance is small, and the probes have a weak contact with earth (such a situation occurs frequently when the earth electrode is well made but the upper soil layer is dry and slightly conductive). Then, the ratio of resistance of the probes to resistance of the tested earth electrode is very high and consequently, uncertainty of δ measurement that depends on this ratio is also very high.
- To reduce the uncertainty of the δ , measurement, the contact of the probe with earth may be improved, for example, by:
 - moistening the spot where the probe is driven with water,
 - driving the probe in a different location,
 - applying an 80 cm probe.Also, test the test leads for:
 - whether their insulation is not defective
 - whether the lead – banana plug – probe contact areas are not corroded or loosened.In majority of cases the achieved measurement accuracy is satisfactory. However, you should always take account of the uncertainty included in the measurement.

Additional information displayed by the meter

READY!	The meter is ready for measurement.
IN PROGRESS	Measurement in progress.
VOLTAGE!	Too high voltage at the meter terminals.
H!	Interruption in the test probe circuit.
S!	Interruption in the voltage probe circuit.
$R_E > 1.99 \text{ k}\Omega$	Measuring range is exceeded.
NOISE!	Signal / noise ratio is too low (interfering signal too large).
LIMIT!	Error due to the resistance of electrodes > 30 % (for calculating uncertainty, measured values are taken into account).
	Interruption in measuring circuit or resistance of test probes is higher than 60 k Ω .

3.6.3 Earth resistance measurement with 4-wire method (R_{E4P})

Four-pole method is recommended for use in the measurement of earth resistance of very small values. It allows user to eliminate the influence of resistance of test leads on the measurement results. It is also suitable for determining the resistivity of the soil. However, it is recommended that the dedicated function should be used for this measurement (**section 3.7**).

- 1 Disconnect the tested earth electrode from the installation of the facility.

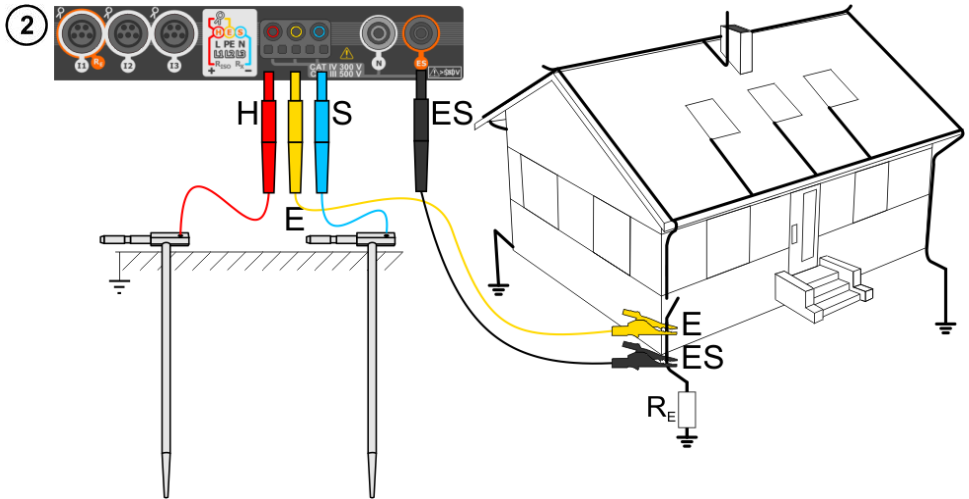
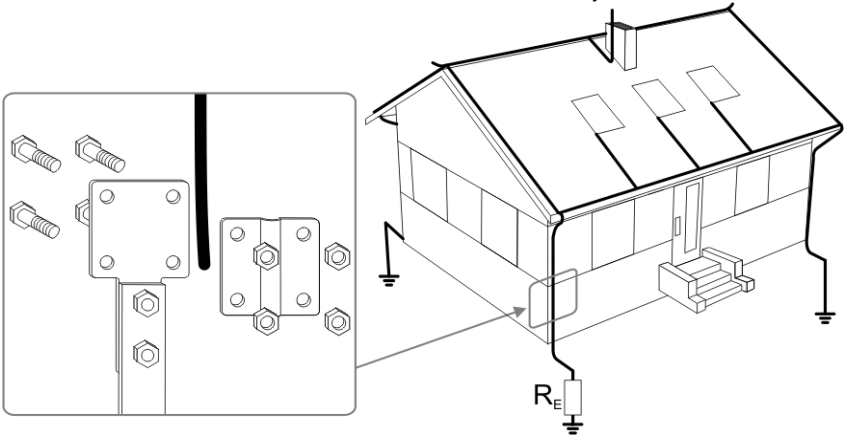

- Drive the **current** electrode into the earth and connect to the **H** socket of the meter.
- Drive the **voltage** electrode into the earth and connect to the **S** socket of the meter.
- The earth electrode being tested should be connected to **E** socket of the meter with the lead.
- **ES** socket should be connected to the tested earth electrode below **E** lead.

- It is recommended that the tested **earth electrode** as well as **H** and **S** electrodes should be located along one line and at relevant distances, in accordance with the rules of earth measurements.

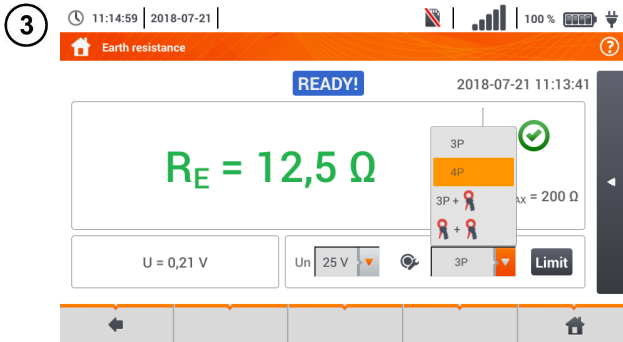

- Select the **4P** option in the measurement menu.
- Select other settings in accordance with **section 3.6.1**.

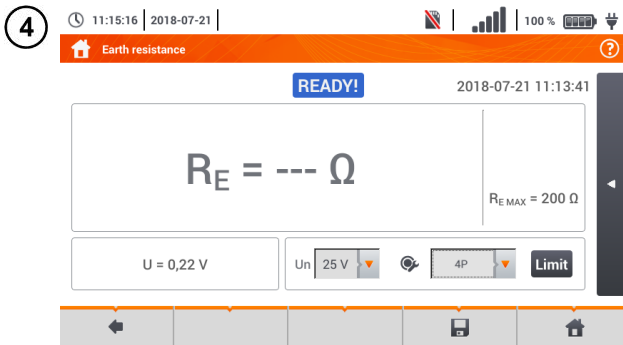

The meter is ready for measurement.

Live mode

U – interference voltage currently on the object

Limits

RE MAX – currently set earth resistance limit



Press **START** to start the measurement.

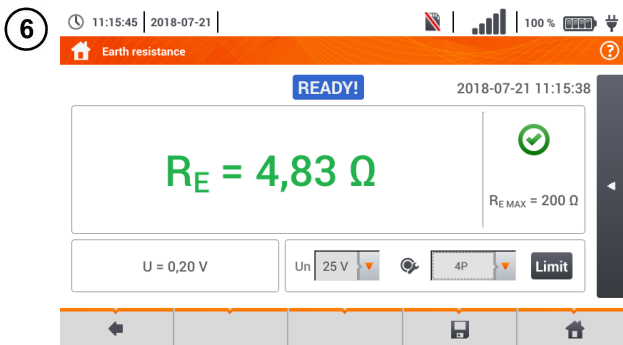

Read out the result.

Signal lights for reaching the limit (**section 3.6.1** step **6**):

- the result is within the set limit
- the result is outside the set limit
- assessment not possible

After selecting the bar on the right side, a menu will slide out with additional measurement results.

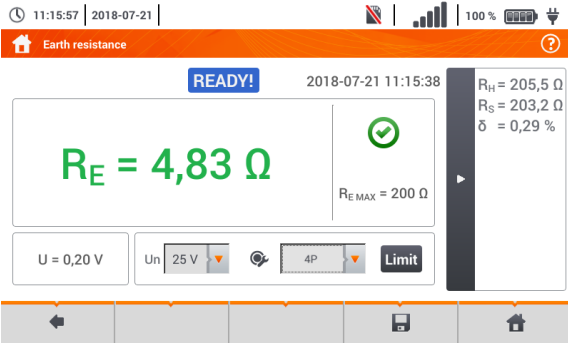

7



R_H – resistance of current electrode
 R_S – resistance of voltage electrode
 δ – additional uncertainty caused by resistance of the electrodes

Selecting the  bar hides the menu.

8

Save the measurement to the meter memory using the  icon. A detailed description of memory management is contained in **section 6.1.3**. The last measurement can be recalled using the  icon.

9

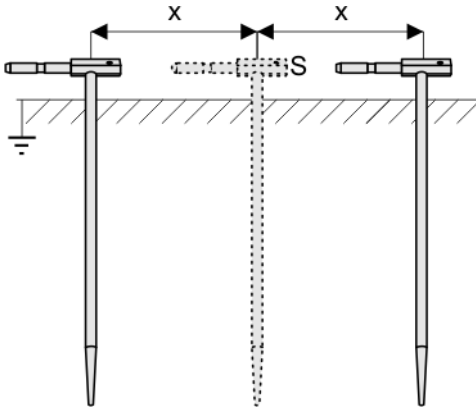

Repeat the steps **2** **5** **6** for two additional locations of the voltage electrode **S**:

- **at a certain distance** from the tested earth electrode,
- **moved closer** by the same distance to the tested earth electrode.

This is done to confirm that the **S** electrode was driven into the reference earth. If so, **the difference between the value of R_E between the main measurement and each additional measurement should not exceed 3%.**

If R_E measurement results differ from one another by more than 3%, the distance of the current electrode from the earth electrode being tested **should be considerably increased** and the measurements should be repeated.



WARNING

- **Measurement of resistance-to-earth may be carried out if voltage of interferences does not exceed 24 V. Voltage of interferences is measured up to the level of 100 V.**
- **Over 50 V it is signalled as hazardous. The meter must not be connected to voltages exceeding 100 V.**



- It is recommended that the test **earth electrode** as well as **H** and **S** electrodes should be located in one line. Due to the different field conditions it is not always possible. On the manufacturer's website and in professional literature special cases of probes location have been discussed.
- Particular attention should be paid to quality of connection between the object being tested and the test lead – the contact area must be free from paint, rust, etc.
- If **resistance of test probes is too high**, R_E earth electrode measurement will **include an additional uncertainty**. Particularly high uncertainty of measurement occurs when the tested resistance is small, and the probes have a weak contact with earth (such a situation occurs frequently when the earth electrode is well made but the upper soil layer is dry and slightly conductive). Then, the ratio of resistance of the probes to resistance of the tested earth electrode is very high and consequently, uncertainty of δ measurement that depends on this ratio is also very high. Then, in accordance with the formulas from **section 11.4.4**, calculations can be made to estimate the influence of measurement conditions.
- To reduce the uncertainty of the δ , measurement, the contact of the probe with earth may be improved, for example, by:
 - moistening the spot where the probe is driven with water,
 - driving the probe in a different location
 - applying an 80 cm probe.Also, test the test leads for:
 - whether their insulation is not defective
 - whether the lead – banana plug – probe contact areas are not corroded or loosened.
- In majority of cases the achieved measurement accuracy is satisfactory. However, you should always take account of the uncertainty included in the measurement.

Additional information displayed by the meter

READY!	The meter is ready for measurement.
IN PROGRESS	Measurement in progress.
VOLTAGE!	Too high voltage at the meter terminals.
H!	Interruption in the test probe circuit.
S!	Interruption in the voltage probe circuit.
$R_E > 1.99 \text{ k}\Omega$	Measuring range is exceeded.
NOISE!	Signal / noise ratio is too low (interfering signal too large).
LIMIT!	Error due to the resistance of electrodes > 30 % (for calculating uncertainty, measured values are taken into account).
	Interruption in measuring circuit or resistance of test probes is higher than 60 k Ω .

3.6.4 Earth resistance measurement with 3-pole method with additional clamp (R_{E3P+C})

1

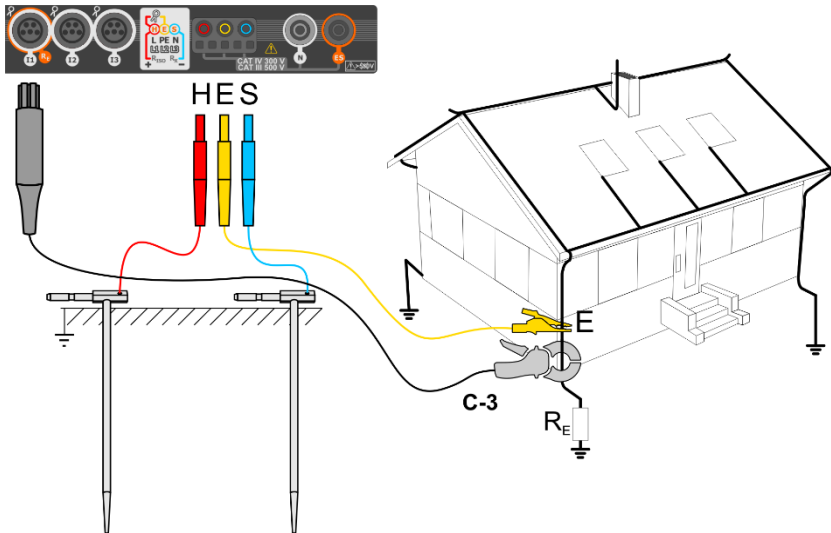

- Drive the **current** electrode into the earth and connect to the **H** socket of the meter.
- Drive the **voltage** electrode into the earth and connect to the **S** socket of the meter.
- The earth electrode being tested should be connected to **E** socket of the meter with the lead.
- It is recommended that the tested **earth electrode** as well as **H** and **S** electrodes should be located along one line and at relevant distances, in accordance with the rules of earth measurements.
- **Receiving clamps** should be attached to the tested earth electrode below the connection point of **E** lead.
- **The arrow on the clamps** can be directed in **any direction**.

2



Select the **3P + clamps** option in the measurement menu.

Select other settings in accordance with **section 3.6.1**.

3

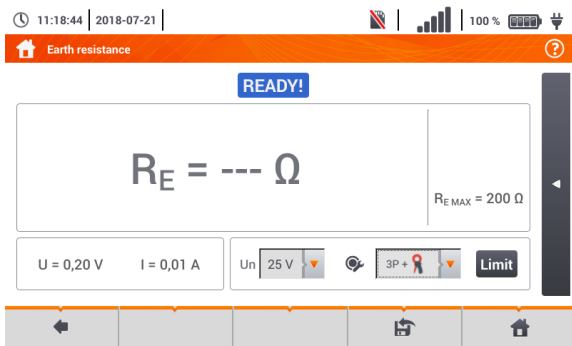

The meter is ready for measurement.

Live mode

U – interference voltage currently on the object

I – interference current currently flowing through the object

Limits

R_E MAX – currently set earth resistance limit

4



Press **START** to start the measurement.

5

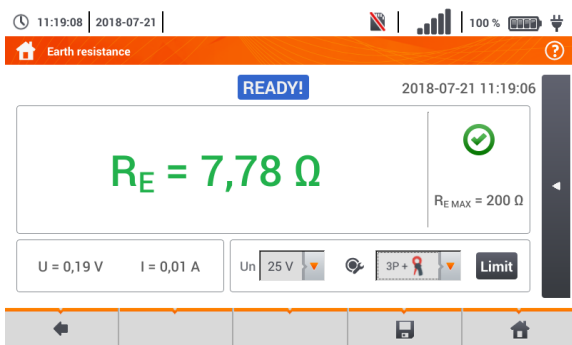

Read out the result.

Signal lights for the limit (section 3.6.1 step 6)

✔ the result is within the set limit

✘ the result is outside the set limit

⋯ assessment not possible

After selecting the bar ◀ on the right side, a menu will slide out with additional measurement results.

6

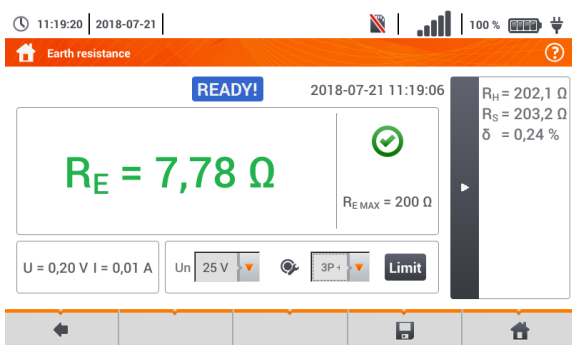



R_H – resistance of current electrode

R_S – resistance of voltage electrode

δ – additional uncertainty caused by resistance of the electrodes

Selecting the ▶ bar hides the menu.

7

Save the measurement to the meter memory using the  icon. A detailed description of memory management is contained in **section 6.1.3**. The last measurement can be recalled using the  icon.

8

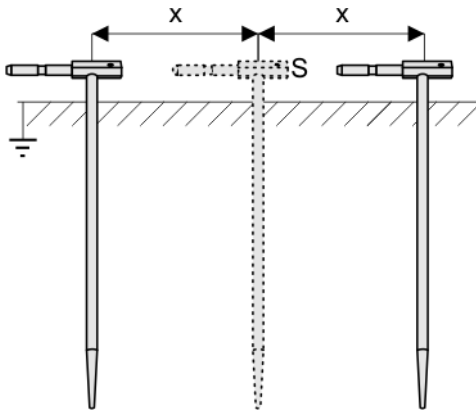

Repeat the steps 2 5 6 for two additional locations of the voltage electrode S:

- **located at a certain distance** from the tested earth electrode,
- **moved closer** by the same distance to the tested earth electrode.

This is done to confirm that the **S** electrode was driven into the reference earth. If so, **the difference between the value of R_E between the main measurement and each additional measurement should not exceed 3%**.

If R_E measurement results differ from one another by more than 3%, the distance of the current electrode from the earth electrode being tested **should be considerably increased** and the measurements should be repeated.



WARNING

- **Measurement of resistance-to-earth may be carried out if voltage of interferences does not exceed 24 V. Voltage of interferences is measured up to the level of 100 V.**
- **Over 50 V it is signalled as hazardous. The meter must not be connected to voltages exceeding 100 V.**



- It is recommended that the test **earth electrode** as well as **H** and **S** electrodes should be located in one line. Due to the different field conditions it is not always possible. On the manufacturer's website and in professional literature special cases of probes location have been discussed.
- Use **C-3 clamps** for the measurement.
- Maximum interference current: 1 A.
- Particular attention should be paid to quality of connection between the object being tested and the test lead – the contact area must be free from paint, rust, etc.
- **If resistance of test probes is too high**, R_E earth electrode measurement will **include an additional uncertainty**. Particularly high uncertainty of measurement occurs when a small value of resistance-to-earth is measured with probes that have a weak contact with earth (such a situation occurs frequently when the earth electrode is well made and the upper soil layer is dry and slightly conductive). Then, the ratio of resistance of the probes to resistance of the tested earth electrode is very high and consequently, uncertainty of measurement that depends on this ratio is also very high. Then, in accordance with the formulas from **section 11.4.4**, calculations can be made to estimate the influence of measurement conditions.
- To reduce the uncertainty of the δ , measurement, the contact of the probe with earth may be improved, for example, by:
moistening the spot where the probe is driven with water,

driving the probe in a different location,
applying an 80 cm probe.











Also, test the test leads for:
whether their insulation is not defective

whether the lead – banana plug – probe contact areas are not corroded or loosened.

In majority of cases the achieved measurement accuracy is satisfactory. However,
you should always take account of the uncertainty included in the measurement.

- Factory calibration does not include the resistance of the test leads. The result displayed by the meter is a sum of the resistance of the measured object and the resistance of leads.

Additional information displayed by the meter

	The meter is ready for measurement.
	Measurement in progress.
	Too high voltage at the meter terminals.
$R_E > 1.99 \text{ k}\Omega$	Measuring range is exceeded.
	Signal / noise ratio is too low (interfering signal too large).
	Error due to the resistance of electrodes > 30 % (for calculating uncertainty, measured values are taken into account).
	Interruption in measuring circuit or resistance of test probes is higher than 60 k Ω .
	Interruption in the test probe circuit.
	Interruption in the voltage probe circuit.
	Too small test current.
	No continuity in the current clamps circuit.

3.6.5 Earth resistance measurement with two-clamp method (2C)



- The double-clamp measurement may be applied where there is no possibility to use electrodes driven into the ground.
- The double-clamp method may only be used when measuring **multiple earthing** (it is necessary to provide a return path for the test current).
- For ring earth electrodes (step ① variant ②b) the method allows **switching off to determine continuity** of the measured earth electrode point with the rest of the earth electrode.

① a

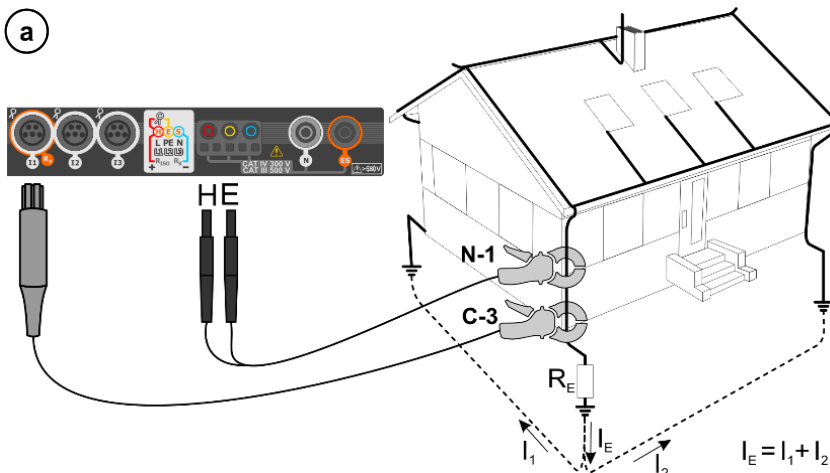

② b

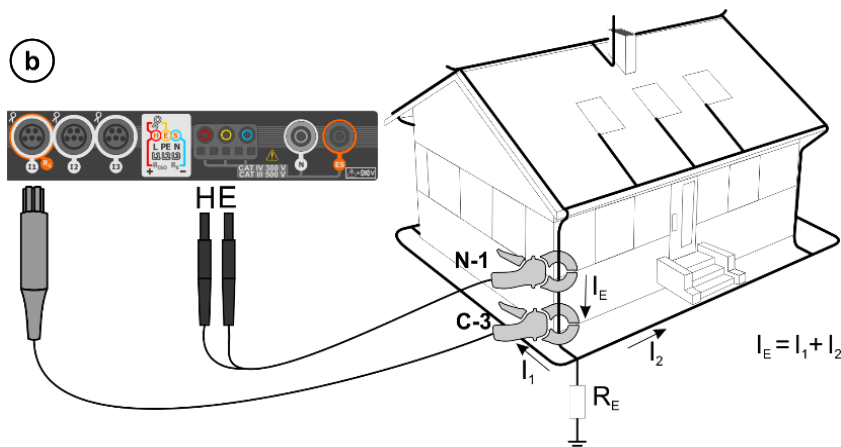

- Transmitting clamps and measuring clamps should be attached to the tested earth electrode **at a distance of at least 30 cm from each other.**
- **The arrow on the clamps can be directed in any direction.**
- Connect the transmitting clamps N-1 to H and E socket.
- Connect the measuring clamps C-3 to the clamp socket.

2



- Select the **clamps + clamps** option in the measurement menu.

- Select other settings in accordance with **section 3.6.1**.

3

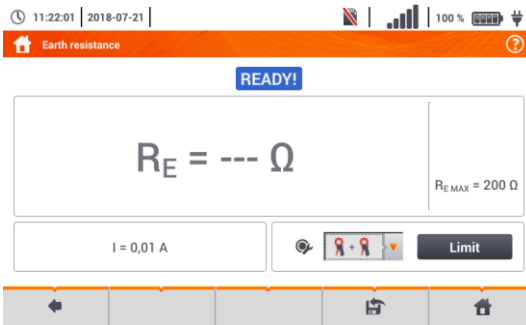

The meter is ready for measurement.

Live mode

I – interference current currently flowing through the object

Limits

R_E MAX – currently set earth resistance limit

4



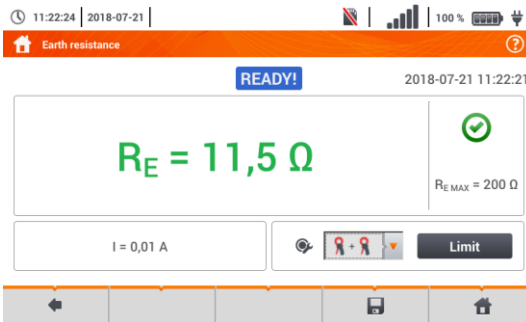

Press **START** to start the measurement.





Read out the result.

Signal lights for the limit (section 3.6.1 step 6)

-  the result is within the set limit
-  the result is outside the set limit
-  assessment not possible







5

Save the measurement to the meter memory using the  icon. A detailed description of memory management is contained in **section 6.1.3**. The last measurement can be recalled using the  icon.



- Measurements may be performed in the presence of interference current of a value not exceeding 3 A RMS and frequency in accordance with the value set in sub-menu **Measurement settings** (section 2.2.1 step ①).
- Use **N-1 clamps** as signal transmitting clamps and **C-3 clamps** as receiving clamps.
- If the current on measuring clamps is too low, the meter displays the following message: **The current measured by clamps is too low. Measurement is not possible!**
- Maximum interference current: 1 A.

Additional information displayed by the meter

	The meter is ready for measurement.
	Measurement in progress.
	Measuring range is exceeded.
	Signal / noise ratio is too low (interfering signal too large).
	Error due to the resistance of electrodes > 30 % (for calculating uncertainty, measured values are taken into account).
	Too small test current.
	No continuity in the current clamps circuit.

3.7 Soil resistivity

For soil resistivity measurements – used as preparation for the designing the earthing system or in geology measurements – a separate function is provided: measurement of soil resistivity ρ . This function is identical to 4-wire measurement of earth resistance, however, it contains an additional procedure of entering the distance between the electrodes. The measurement result is the resistivity value, calculated automatically according to the formula applied in Wenner method:

$$\rho = 2\pi LR_E$$

where:

L – distance between the electrodes (all distances must be equal),

R_E – measured resistance.

3.7.1 Settings of measurements

1



Select item Ωm .

2

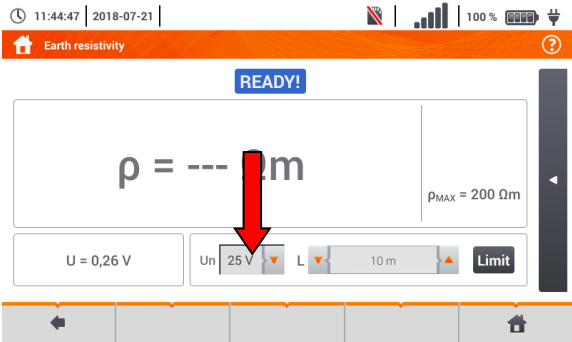

Touch the parameter drop-down menu U_n (measuring voltage selection).

3



Select the required measuring voltage from the list.

4

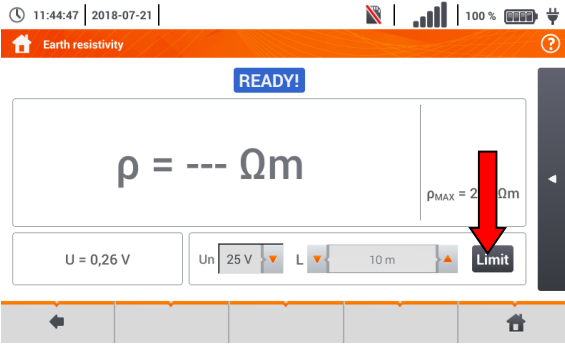

Select **Limit** to set the soil resistivity limit.

5

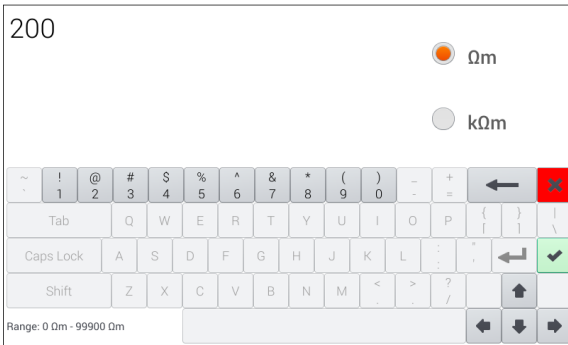

- Select unit.
- Enter the required resistance limit value:
 ⇒ **Ωm**: 0...99 900,
 ⇒ **kΩm**: 0...100.

Functions of icons

- reject changes and exit to the previous screen
- accept changes

3.7.2 Main elements of the screen

1



Select item **Soil resistivity Ωm**.

2

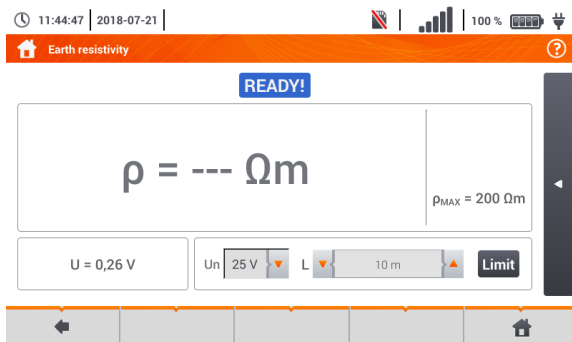

The measurement screen will appear.

Live mode

U – interference voltage

Limits

ρMAX – soil resistivity limit

After selecting the bar on the right side, a menu will slide out with additional measurement results.

3

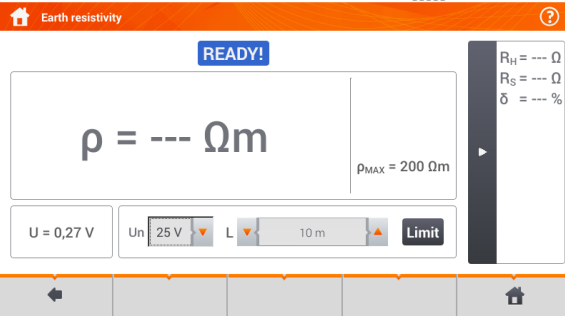

R_H – resistance of current electrode
 R_S – resistance of voltage electrode
 δ – additional uncertainty caused by resistance of the electrodes

Selecting the  bar hides the menu.

3.7.3 Soil resistivity measurements (ρ)

1

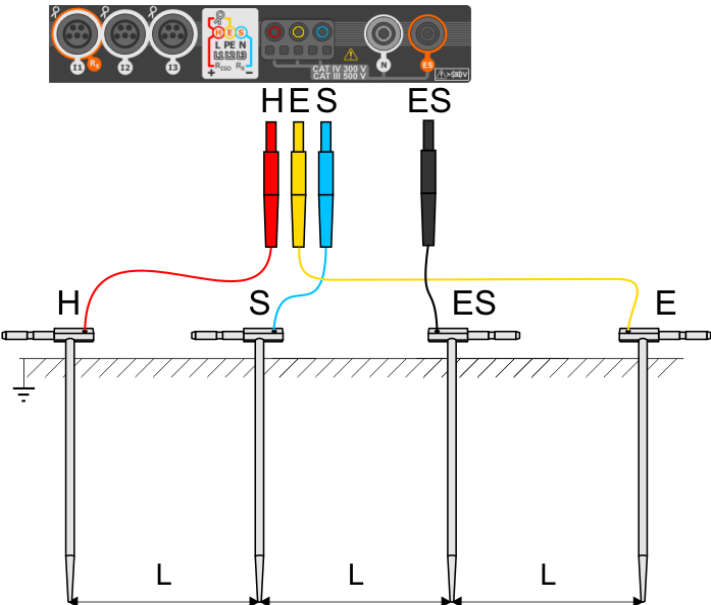

- Drive 4 probes into the ground **in one line** and at **equal** distances.
- Connect the probes to the meter according to the figure above.

2

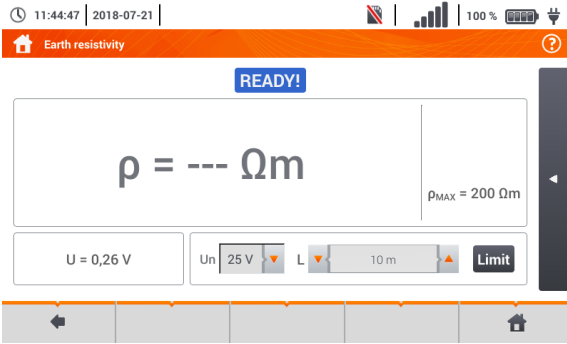

- Call up the measurement menu.

- Select other settings in accordance with **section 3.7.1**.

3



Select distance **L** between the measuring electrodes:

(b)

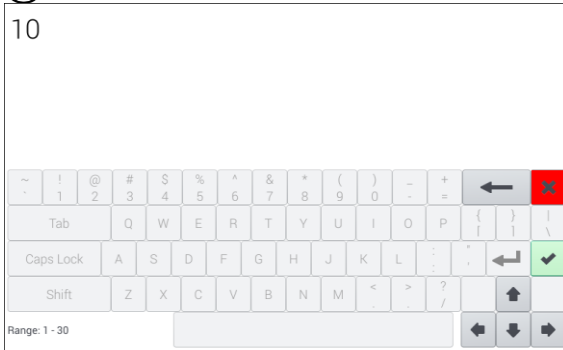

- (a) using arrows ▲ ▼ ,
- (b) from the keyboard after touching the field with the distance value (range 1...30 m)

Functions of icons

- reject changes and exit to the previous screen
- accept changes

4

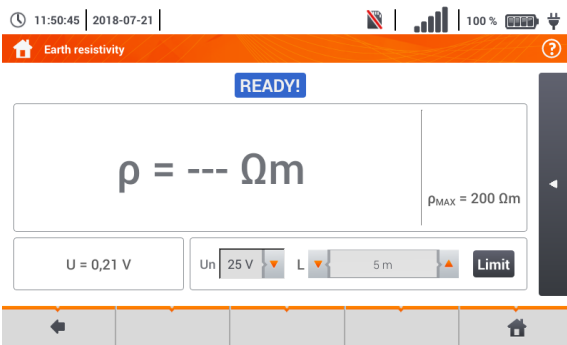

The meter is ready for measurement.

5



Press **START** to start the measurement.

6

11:51:55 | 2018-07-21 |



Read out the result.

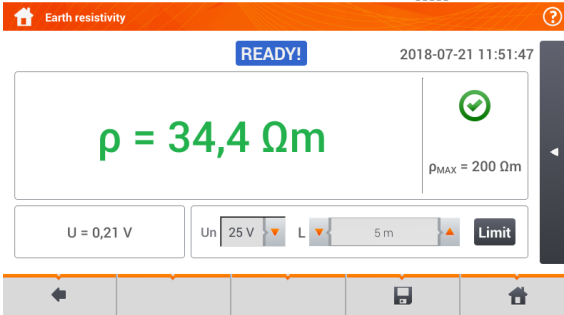

Signal lights for reaching the limit (section 3.7.1 step 4):

- the result is within the set limit
- the result is outside the set limit
- assessment not possible

After selecting the bar on the right side, a menu will slide out with additional measurement results.

7

11:52:07 | 2018-07-21 |

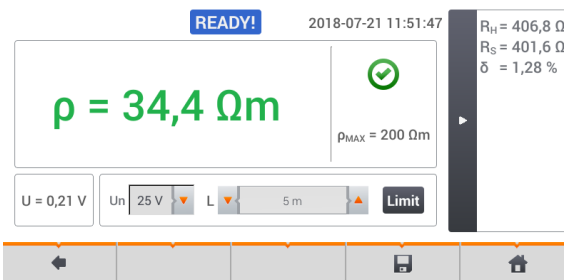
 R_H – resistance of current electrode R_S – resistance of voltage electrode δ – additional uncertainty caused by resistance of the electrodes

Selecting the bar hides the menu.

8

Save the measurement to the meter memory using the icon. A detailed description of memory management is contained in section 6.1.3. The last measurement can be recalled using the icon.

**WARNING**

- Measurement of resistivity may be carried out if voltage of interferences does not exceed 24 V. Voltage of interferences is measured up to the level of 100 V.
- Over 50 V it is signalled as hazardous. The meter must not be connected to voltages exceeding 100 V.



- The calculations assume that the distance between the measuring electrodes are equal (Wenner method). If it is not the case, perform the measurement of earth resistance using 4-pole method and calculate resistivity from the formula:

$$\rho = 2\pi LR_E$$

where:

L – distance between the electrodes

R_E – measured resistance

- Particular attention should be paid to quality of connection between the object being tested and the test lead – the contact area must be free from paint, rust, etc.
- If **resistance of test probes is too high**, resistivity measurement **will include an additional uncertainty**. A particularly large measurement uncertainty arises when a small resistance value is measured with probes that have weak contact with the ground. Then, the ratio of resistance of the probes to measured resistance as a resistivity formula component is very high and consequently, uncertainty of measurement that depends on this ratio is also very high. Then, in accordance with the formulas from **section 11.4.4**, calculations can be made to estimate the influence of measurement conditions.
- To reduce the uncertainty of the $\bar{\delta}$, measurement, the contact of the probe with earth may be improved, for example, by:
moistening the spot where the probe is driven with water,
driving the probe in a different location,
applying an 80 cm probe.

Also, test the test leads for:

whether their insulation is not defective

whether the lead – banana plug – probe contact areas are not corroded or loosened.

In majority of cases the achieved measurement accuracy is satisfactory. However, you should always take account of the uncertainty included in the measurement.

Additional information displayed by the meter

READY!	The meter is ready for measurement.
IN PROGRESS	Measurement in progress.
VOLTAGE!	Too high voltage at the meter terminals.
H!	Interruption in the test probe circuit.
S!	Interruption in the voltage probe circuit.
RE>1.99 kΩ	Measuring range is exceeded.
NOISE!	Signal / noise ratio is too low (interfering signal too large).
LIMIT!	Error due to the resistance of electrodes > 30 % (for calculating uncertainty, measured values are taken into account).
	Interruption in measuring circuit or resistance of test probes is higher than 60 kΩ.

3.8 RCD parameters



The measurement of U_B , R_E is always performed with sinusoidal current $0.4 I_{\Delta n}$ regardless of the settings concerning waveform and multiplication factor $I_{\Delta n}$.

3.8.1 Settings of measurements

1



Select item **RCD I_A** or **RCD t_A** .

2

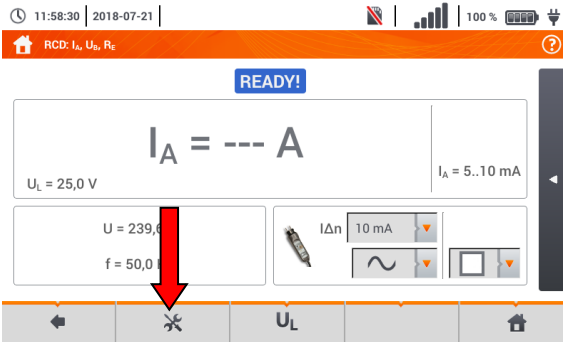

Define the displayed measurement components with the 

icon:

- a) if **RCD I_A** has been selected,
- b) if **RCD t_A** has been selected.

3a

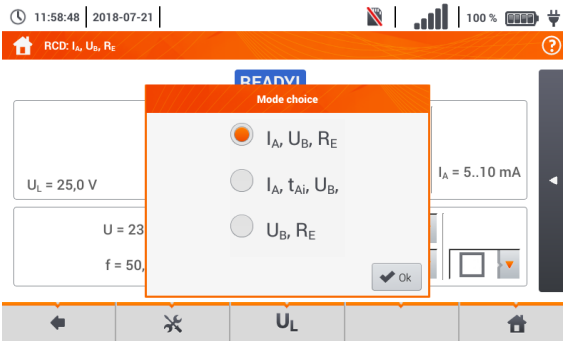

For **RCD I_A** the following parameters are available:

- I_A – RCD tripping current,
- U_B – voltage measured on PE,
- R_E – PE continuity,
- t_{Ai} – RCD triggering time when measuring tripping current.

3b

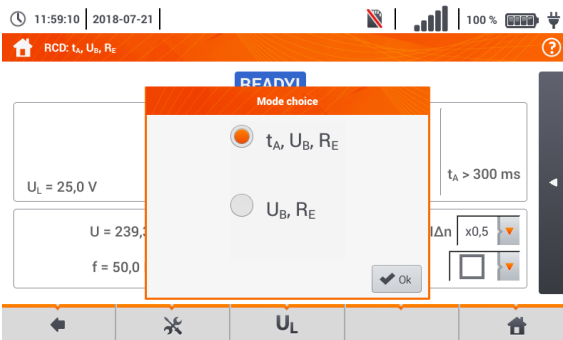

For **RCD t_A** the following parameters are available:

- U_B – voltage measured on PE,
- R_E – PE continuity,
- t_A – RCD triggering time when given the rated differential current ratio.

4

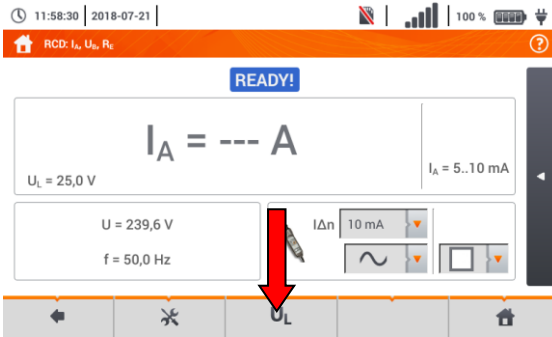

Select U_L to define the measuring voltage.

5

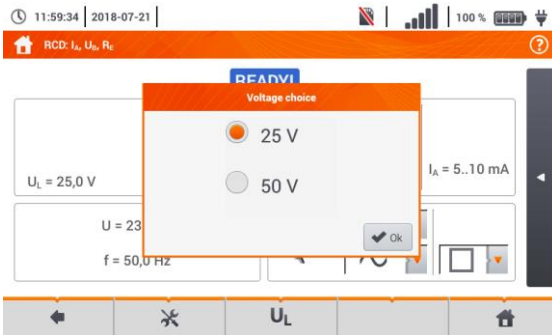

Select the required measuring voltage from the list.

6

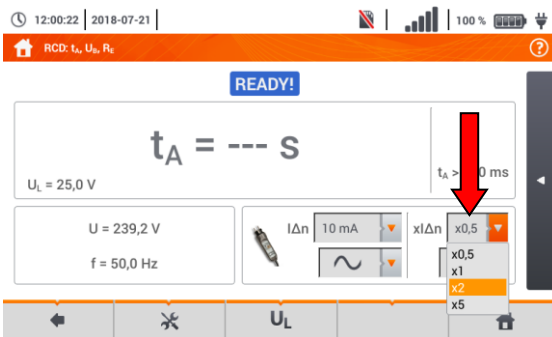

If the RCD t_A mode has been selected in step ①, set the forced current in the RCD test.

The set current is ratio of the rated residual current of the tested circuit breaker.

7

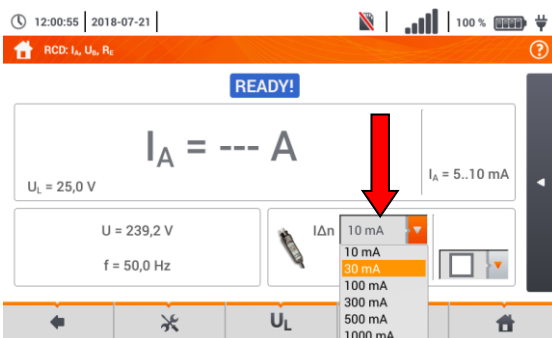

The correctness of the assessment of the test circuit breaker efficiency is dependent on the rated residual current.

Rated differential currents of RCDs are available in the menu.

- Touch the drop-down list field.
- Select the residual current of the test circuit breaker.

8

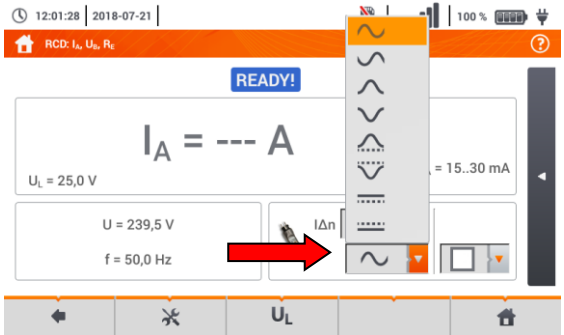

In the menu you can the wave-form of the current, which will be used to test the RCD.

- Touch the drop-down list field. Select the waveform of the measuring current.

9

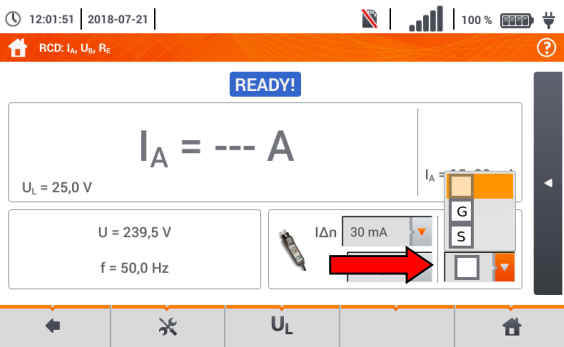

Determine the type of circuit breaker.

Available circuit breaker types

- general purpose
- G short-time delay type
- S selective

3.8.2 RCD tripping current

1 Connect the meter to the installation according to the drawing.

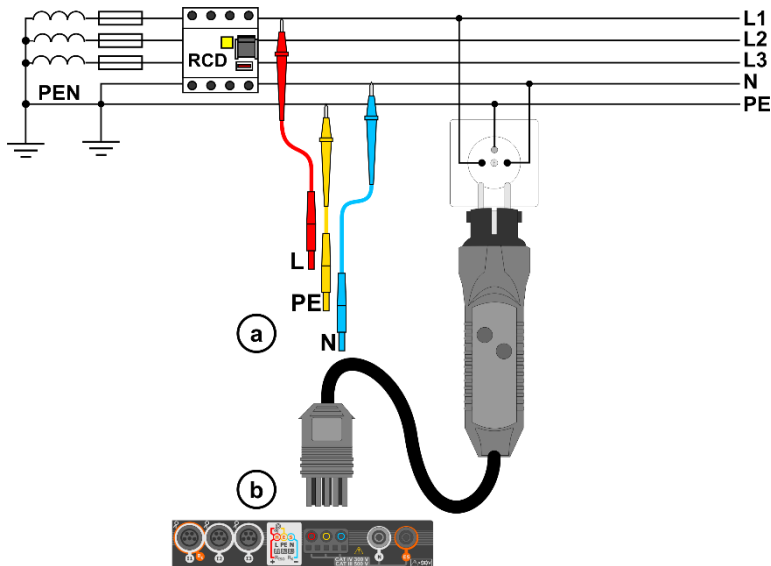

2



Select item **RCD I_A**.

3

Enter the measurement settings in accordance with **section 3.8.1**.

4

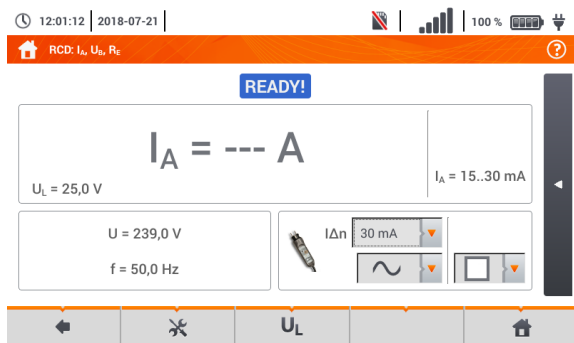

The meter is ready for measurement.

Live mode

U – voltage between phase conductor L and PE conductor
f – network frequency in the tested circuit

5



Press **START** to start the measurement.

To cancel measurement, select the  icon on the screen.

6

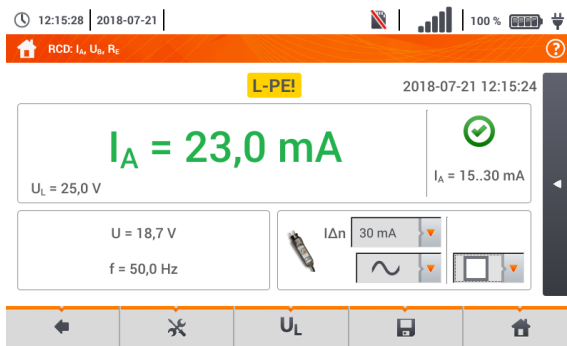

Read out the result.

Measurement result assessment

green:

$$0.5 I_{\Delta n} < I_A \leq I_{\Delta n}$$

red:

$$I_A \leq 0.5 I_{\Delta n} \\ \text{or} \\ I_A > I_{\Delta n}$$

After selecting the bar  on the right side, a menu will slide out with additional measurement results.

7

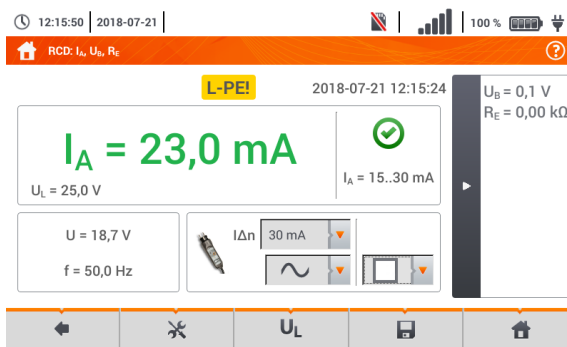



Depending on the selection made in section 3.8.1 step 2 some of the parameters below will be displayed:

UB – voltage measured on PE,
RE – PE continuity,
tA – RCD triggering time with flow of RCD disconnecting current.

Selecting the  bar hides the menu.

8

Save the measurement to the meter memory using the  icon. A detailed description of memory management is contained in section 6.1.3. The last measurement can be recalled using the  icon.



- Measurement of the triggering time t_{Ai} (t_A measured during I_A measurement) for **selective RCDs** is not available.
- The measurement of triggering time t_{Ai} is **not performed as required** by applicable standards (i.e **with RCD nominal current** $I_{\Delta n}$), but **with I_A current** measured and displayed during the measurement. In most cases where the measurement does not have to be strictly as defined by the standard, this measurement may be taken into account to assess the proper operation of RCD protection in a particular installation. When measured I_A is lower than $I_{\Delta n}$ (most frequent case), then triggering time t_{Ai} will be usually longer than the triggering time measured in function t_A , which measures the time at $I_{\Delta n}$ current:

$$I_A < I_{\Delta n} \Rightarrow t_{Ai} > t_A$$

where:

$$t_{Ai} = f(I_{\Delta n})$$

Therefore, when time t_{Ai} is s correct (not too long), it may be assumed that the time measured in function t_A would be also correct (it would not be longer).

Additional information displayed by the meter

IN PROGRESS	Measurement in progress.
U_B>U_L!	The touch voltage exceeds a preset U _L threshold value.
READY!	The meter is ready for measurement.
L-N!	U _{L-N} voltage is incorrect for making a measurement.
L-PE!	U _{L-PE} voltage is incorrect for making a measurement.
N-PE!	U _{N-PE} voltage is incorrect for making a measurement.
L ↔ N	Phase connected to N terminal instead of L terminal (for example, exchange of L and N in the mains socket).
f!	Network frequency is outside the range of 45...65 Hz.
PE!	PE conductor connected incorrectly.
ERROR!	Measurement error.
U>500V!	Before measurement, voltage at test terminals exceeds 500 V.

3.8.3 RCD tripping time

- 1 Connect the meter to the installation according to the drawing.

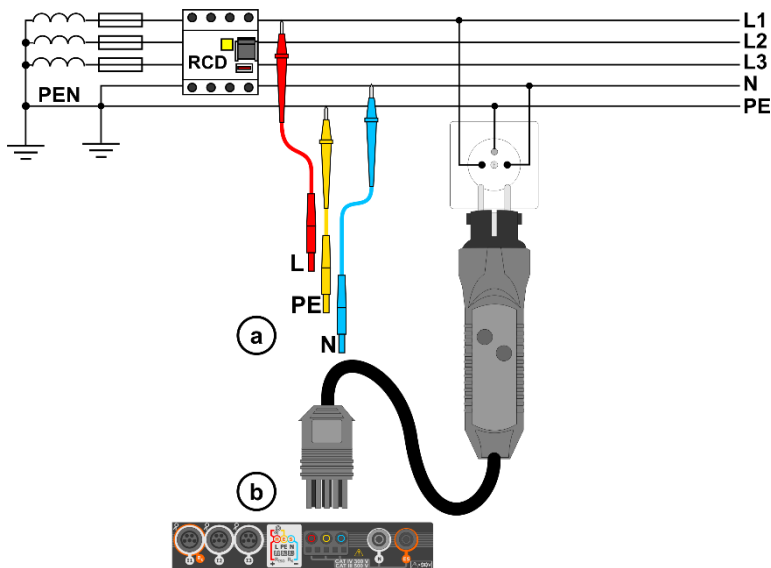

- 2



Select item **RCD t_A** .

- 3

Enter the measurement settings in accordance with **section 3.8.1**.

- 4

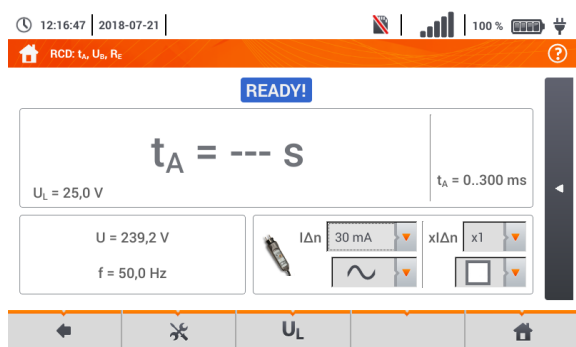

The meter is ready for measurement.

Live mode

U – voltage between phase conductor L and PE conductor
f – network frequency in the tested circuit

- 5



Press **START** to start the measurement.

6

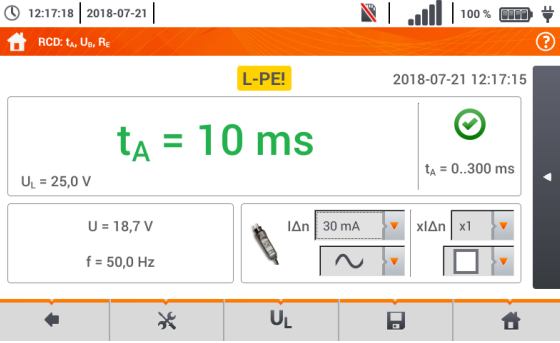

Read the result – RCD triggering time t_A .

Measurement result assessment green:

$$t_A \leq t_{dop}$$

red:

$$t_A > t_{dop}$$

After selecting the bar  on the right side, a menu will slide out with additional measurement results.

7

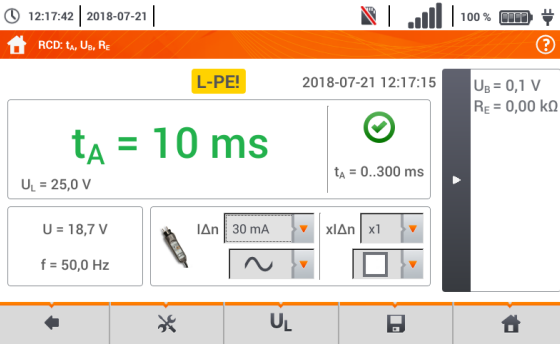



Depending on the selection made in section 3.8.1 step ② some of the parameters below will be displayed:

U_B – voltage measured on PE,
 R_E – PE continuity.

Selecting the  bar hides the menu.

8

Save the measurement to the meter memory using the  icon. A detailed description of memory management is contained in **section 6.1.3**. The last measurement can be recalled using the  icon.

Additional information displayed by the meter

IN PROGRESS	Measurement in progress.
$U_B > U_L!$	The touch voltage exceeds a preset U_L threshold value.
No $U_{L-N}!$	Lack of neutral lead that is necessary for $I_{\Delta n}$ constant and pulsed with direct current offset
READY!	The meter is ready for measurement.
L-N!	U_{L-N} voltage is incorrect for making a measurement.
L-PE!	U_{L-PE} voltage is incorrect for making a measurement.
N-PE!	U_{N-PE} voltage is incorrect for making a measurement.
L ↔ N	Phase connected to N terminal instead of L terminal (for example, exchange of L and N in the mains socket).
TEMPERATURE!	Maximum temperature of the meter is exceeded.
f!	Network frequency is outside the range of 45...65 Hz.
PE!	PE conductor connected incorrectly.
ERROR!	Measurement error.
$U > 500V!$	Before measurement, voltage at test terminals exceeds 500 V.
VOLTAGE!	Voltage exceeded.

3.8.4 Measurements in IT networks

Before performing measurements select the appropriate network type in the main menu (menu **Measurement settings**, section 2.2.1).



NOTE!

After selecting an IT type network, the function of the **contact electrode** is **inactive**.

The manner of connecting the device to the installation is shown in **Fig. 3.8** and **Fig. 3.9**.

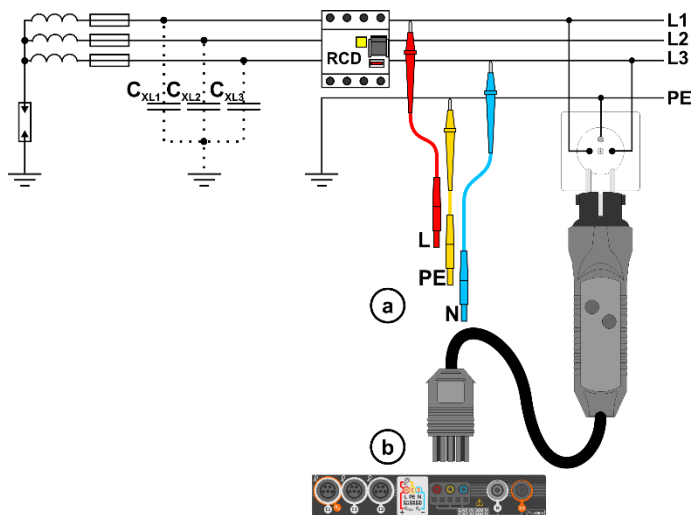

Fig. 3.8 RCD measurement in the IT network. The circuit is closed by the parasitic capacitances C_x

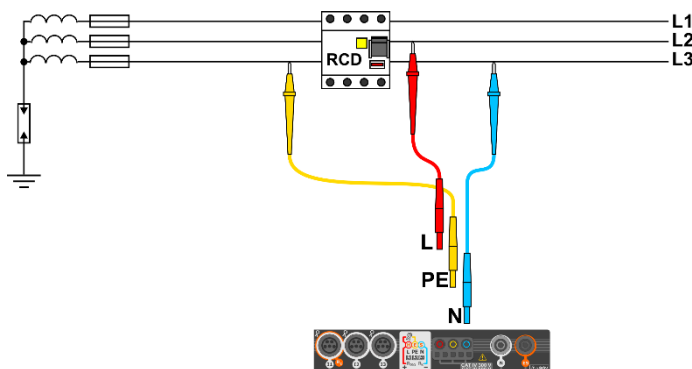

Fig. 3.9 RCD testing without the PE conductor

The manner in which the measurements of current and the RCD triggering time has been described in **section 3.8.2,3.8.3**.

Operating voltage range: **95 V ... 270 V**.

3.9 Automatic measurements of RCD parameters

The meter enables user to measure automatically RCD triggering time (t_A), disconnection current (I_A), contact voltage (U_B) and resistance-to-earth (R_E). In this mode, there is no need to trigger each measurement by pressing **START** button. The role of the user is reduced to initiating the measurement by single pressing **START** and switching RCD on after each tripping.

3.9.1 Setting automatic measurements of RCD parameters

1



Select **RCD_{AUTO}**.

2



- Select **U_L** and from then select the required measuring voltage from the list.



- Select the rated differential current of tested protection.



- Select the type of tested protection.

3



- Select the parameters to be measured. Designations:

I_A tripping current

t_A response time

+ current with increasing head is forced

- current with decreasing head is forced

x0.5 / 1 / 2 / 5 a multiplicity of RCD rated current, according to IEC 61557-6

- Select the metering mode:

(a) full,

(b) standard.

4a



If **full** mode has been selected, select the type of tested protection.



RCD other than EV. There is no 6 mA DC module in this type of device.



EV type RCD. Here there is a 6 mA DC module. In this situation, before the test it is necessary to:

- determine according to which standard the measurement is to be carried out (**sec. 2.2.1**),

- determine the multiplication factor of the 6 mA DC differential current (**EV** button). The test settings vary depending on the selected standard.



RCD other than the EV, which is protected by a RCM (residual current monitoring device at 6 mA DC). In this situation, before the test it is necessary to:

- determine according to which standard the measurement is to be carried out (**sec. 2.2.1**),
- tick **RCM**,
- determine the multiplication factor of the 6 mA DC differential current (**EV** button). The test settings vary depending on the selected standard.

4b



If **standard** mode has been selected, set the shape of the testing current. In this mode, RCD EV and RCM tests are unavailable.

3.9.2 Automatic measurement of RCDs

1 Connect the meter to the installation according to the drawing.

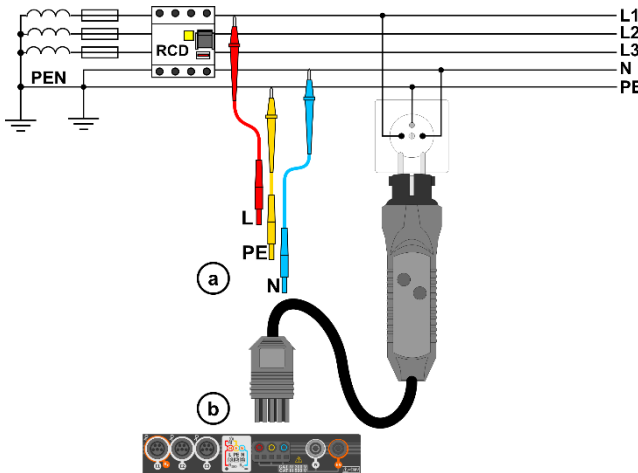

2



Select **RCD_{AUTO}**.

3 Enter the measurement settings in accordance with **section 3.9.1**.

4

The meter is ready for measurement.

Live mode

U – voltage between phase conductor L and PE conductor
f – network frequency in the tested circuit

5



Press **START** to start the measurement.

6

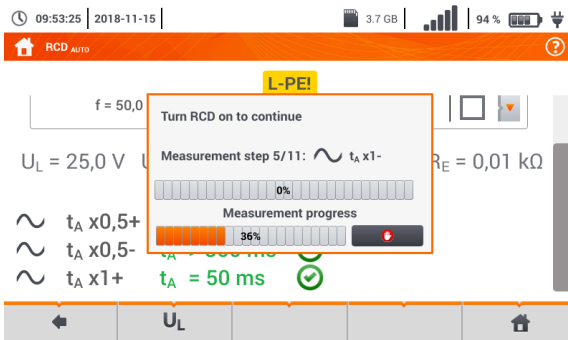

Tested RCD switch, must be **turned on** after each triggering, measurements are **completed**.

The progress of the measurement is illustrated by progress bars: **top** – progress of the ongoing measurement, **bottom** – progress of the entire measurement sequence.

The sequence may be cancelled at any time using icon

7

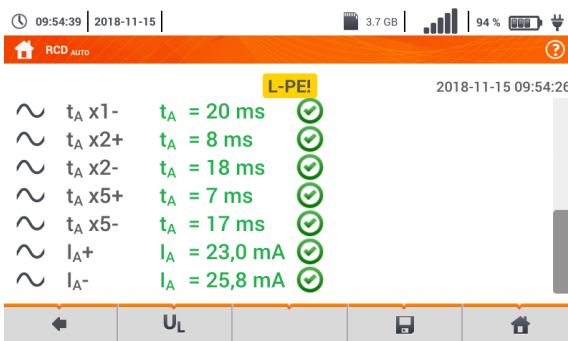

Eventually, measured parameters are displayed (**sec. 3.9.1** step 5), and:

U_L – test voltage,
U_{L-PE} – voltage between L and PE,
U_B – voltage measured on PE,
R_E – PE continuity.

The list of results may be scrolled on the screen.

Symbols indicating correctness of response

✓ criterion met

✗ criterion not met

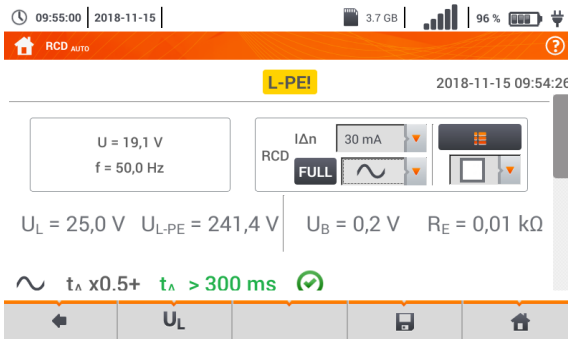

For more information refer to **Criteria for assessing the correctness of component results**.

8

Save the measurement to the meter memory using the icon. A detailed description of memory management is contained in **section 6.1.3**. The last measurement can be recalled using the icon.



- U_B and R_E are always measured.
- The measurement of U_B , R_E is always performed with sinusoidal current $0.4 I_{\Delta n}$ regardless of the settings concerning waveform and multiplication factor $I_{\Delta n}$.
- Automatic measurement is interrupted in the following cases:
the switch was tripped during the measurement of U_B , R_E or t_A at the half value of $I_{\Delta n}$,
the switch did not trip during other component measurements,
the value of pre-set voltage U_L has been exceeded,
voltage was disconnected during one of the component measurements,
values R_E and mains voltage did not allow to generate the required current value for one of component measurements.
- The meter automatically skips the measurements impossible to perform, e.g. when the value of selected current $I_{\Delta n}$ and its multiplicity exceed the testing range of the meter.

Criteria for assessing the correctness of component results

Parameter	Assessment criterion	Notes
$I_A \sim$	$0.5 I_{\Delta n} \leq I_A \leq 1 I_{\Delta n}$	-
$I_A \sim \sim$ $I_A \sim \sim \sim$	$0.35 I_{\Delta n} \leq I_A \leq 2 I_{\Delta n}$	for $I_{\Delta n} = 10 \text{ mA}$
$I_A \sim \sim$ $I_A \sim \sim \sim$	$0.35 I_{\Delta n} \leq I_A \leq 1.4 I_{\Delta n}$	for other $I_{\Delta n}$
$I_A \dots$	$0.5 I_{\Delta n} \leq I_A \leq 2 I_{\Delta n}$	-
$I_A \dots 6 \text{ mA}$	$3 \text{ mA} \leq I_A \leq 6 \text{ mA}$	for 6 mA RCD <input type="checkbox"/> EV and RCM (acc. to IEC 62955 and IEC 62752)
t_A at $0.5 I_{\Delta n}$	$t_A \rightarrow \text{rcd}$	▪ for all types of RCD ▪ for AC module of RCD <input type="checkbox"/> EV
t_A at $1 I_{\Delta n}$	$t_A \leq 300 \text{ ms}$	▪ for general purpose RCDs <input type="checkbox"/> ▪ for AC module of RCD <input type="checkbox"/> EV
t_A at $2 I_{\Delta n}$	$t_A \leq 150 \text{ ms}$	▪ for general purpose RCDs <input type="checkbox"/> ▪ for AC module of RCD <input type="checkbox"/> EV
t_A at $5 I_{\Delta n}$	$t_A \leq 40 \text{ ms}$	▪ for general purpose RCDs <input type="checkbox"/> ▪ for AC module of RCD <input type="checkbox"/> EV
t_A at $1 I_{\Delta n}$	$130 \text{ ms} \leq t_A \leq 500 \text{ ms}$	for selective RCDs <input type="checkbox"/> S
t_A at $2 I_{\Delta n}$	$60 \text{ ms} \leq t_A \leq 200 \text{ ms}$	for selective RCDs <input type="checkbox"/> S
t_A at $5 I_{\Delta n}$	$50 \text{ ms} \leq t_A \leq 150 \text{ ms}$	for selective RCDs <input type="checkbox"/> S
t_A at $1 I_{\Delta n}$	$10 \text{ ms} \leq t_A \leq 300 \text{ ms}$	for short-time delay RCDs <input type="checkbox"/> G
t_A at $2 I_{\Delta n}$	$10 \text{ ms} \leq t_A \leq 150 \text{ ms}$	for short-time delay RCDs <input type="checkbox"/> G
t_A at $5 I_{\Delta n}$	$10 \text{ ms} \leq t_A \leq 40 \text{ ms}$	for short-time delay RCDs <input type="checkbox"/> G
t_A at $1 I_{\Delta n}$	$t_A \leq 10 \text{ s}$	for 6 mA RCD <input type="checkbox"/> EV and RCM ($I_A = 6 \text{ mA}$ acc. to IEC 62955 and IEC 62752)
t_A at $10 I_{\Delta n}$	$t_A \leq 300 \text{ ms}$	for 6 mA RCD <input type="checkbox"/> EV and RCM ($I_A = 60 \text{ mA}$ acc. to IEC 62955 and IEC 62752)
t_A at $33 I_{\Delta n}$	$t_A \leq 100 \text{ ms}$	for 6 mA RCD <input type="checkbox"/> EV and RCM ($I_A = 200 \text{ mA}$ acc. to IEC 62955)
t_A at $50 I_{\Delta n}$	$t_A \leq 40 \text{ ms}$	for 6 mA RCD <input type="checkbox"/> EV and RCM ($I_A = 300 \text{ mA}$ acc. to IEC 62752)

Additional information displayed by the meter

IN PROGRESS	Measurement in progress.
$U_B > U_L!$	The touch voltage exceeds a preset U_L threshold value.
No $U_{L-N}!$	Lack of neutral lead that is necessary for $I_{\Delta n}$ constant and pulsed with direct current offset
READY!	The meter is ready for measurement.
L-N!	U_{L-N} voltage is incorrect for making a measurement.
L-PE!	U_{L-PE} voltage is incorrect for making a measurement.
N-PE!	U_{N-PE} voltage is incorrect for making a measurement.
L ↔ N	Phase connected to N terminal instead of L terminal (for example, exchange of L and N in the mains socket).
TEMPERATURE!	Maximum temperature of the meter is exceeded.
f!	Network frequency is outside the range of 45...65 Hz.
PE!	PE conductor connected incorrectly.
ERROR!	Measurement error.
U>500V!	Before measurement, voltage at test terminals exceeds 500 V.
VOLTAGE!	Voltage exceeded.

3.10 Insulation resistance



WARNING

The tested object must not be live.

3.10.1 Settings of measurements

1



Select item R_{ISO} .

2

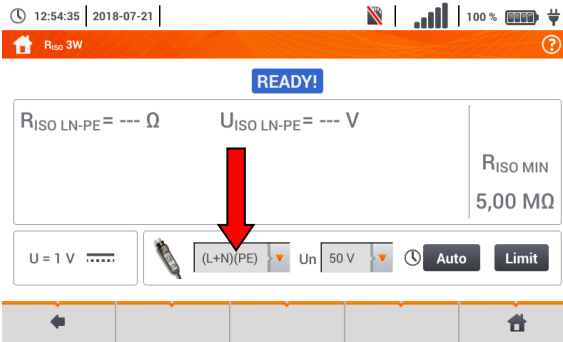

Connect the meter probe or the adapter which the measurements will be performed with.

Touch the drop down menu to set the measuring mode.

Positions will vary depending on whether the following have been connected to the meter:

- a) probes,
- b) UNI-Schuko adapter,
- c) AutoISO-1000c adapter

3a



If **separate leads with probes** have been connected to the meter, select the required option from the menu:

- **single measurement mode** – the measurement continues only when the user holds the START button,
- ↻ **continuous measurement mode** – the measurement is triggered by a short press of the START button and ends when START is pressed again.

3b



If **UNI-Schuko** adapter has been connected to the meter, select the required option from the menu:

- ⇒ **(L)(PE)(N)** – if the **phase** conductor on the **left** relative to the socket protective pin,
- ⇒ **(N)(PE)(L)** – if the **phase** conductor on the **right** relative to the socket protective pin,
- ⇒ **(L+N)(PE)** – shorted L and N conductors, measurement to PE (simplified method).

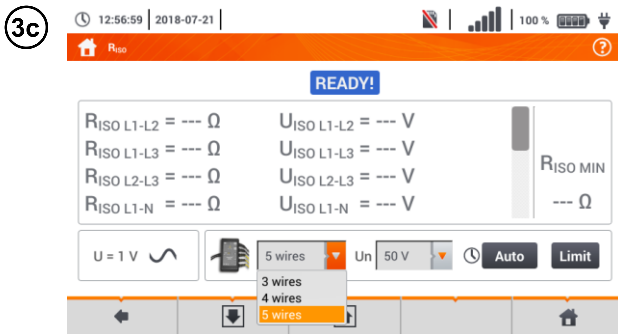

If **AutoISO** adapter has been connected to the meter, select the required option from the menu:

- ⇒ **3 wires** – measuring a 3-core cable,
- ⇒ **4 wires** – measuring a 4-core cable,
- ⇒ **5 wires** – measuring a 5-core cable.

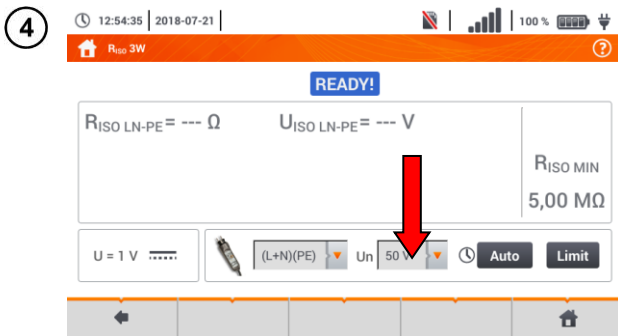

Touch the drop down menu to set the measuring voltage **Un**.



Select the required measuring voltage from the list.

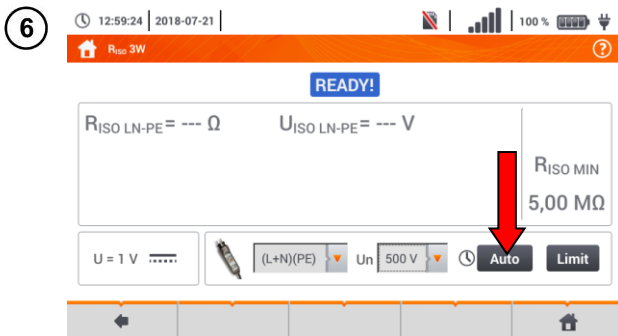

Set the measurement duration using the icon. After the selection has been made, it will display the set value.

7

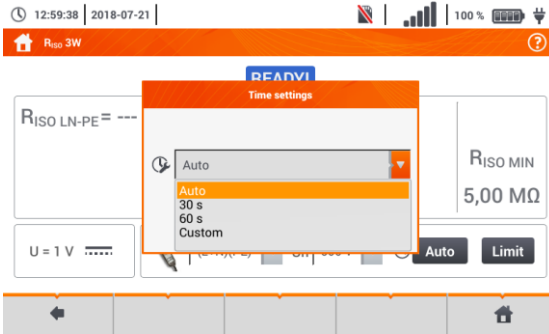

Available options

- ⇒ **Auto** – the meter automatically selects measurement duration depending on the capacity of the object measured
- ⇒ 30 s
- ⇒ 60 s
- ⇒ **Custom** – manual setting of time within the range of 1...60 s

8

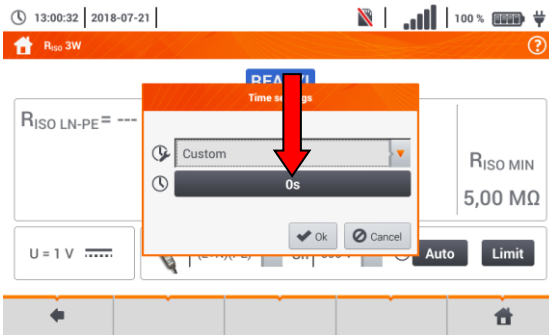

If the **Custom** option has been selected, enter the required time.

9

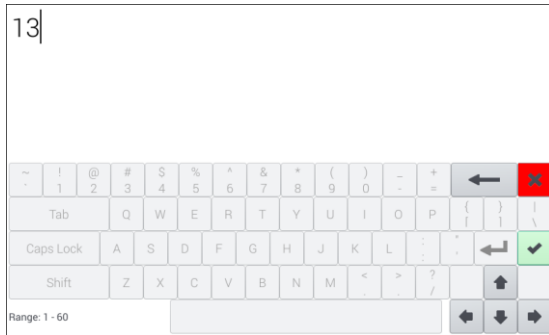

Delete the previous time value and enter a new one from the range of 1...60 s.

Functions of icons

- reject changes and exit to the previous screen
- accept changes

10



Description of function icons

- Ok** – accept selection
- Cancel** – reject changes

11

Select **Limit** to set the acceptable insulation resistance criterion.



12



- Select unit.
- Delete the previous value and enter a new one. Ranges:
 - ⇒ **kΩ**: 0...2 000 000,
 - ⇒ **MΩ**: 0.0...2000.0,
 - ⇒ **GΩ**: 0.000...2.000.

Functions of icons

- rejecting changes and exit to the previous screen
- accepting changes

13

- returning to the previous screen
- going to the main menu



3.10.2 Measurement using probes



WARNING

- During measurements of insulation resistance, dangerous voltage up to 1 kV occurs at the ends of test leads of the meter.
- **It is forbidden** to disconnect test leads before the measurement is completed. Failure to obey the above instruction will lead to **electric shock with high voltage** and make it impossible to discharge the tested object.

1



Select item R_{ISO} to call up the measurement menu.

2

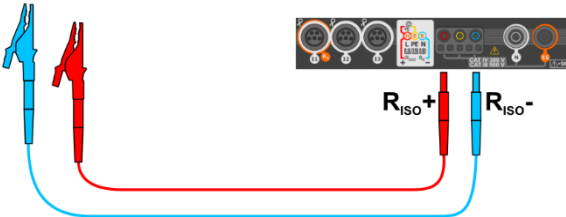

Connect the probes to the meter.

3

Enter the measurement settings in accordance with **section 3.10.1**.

4

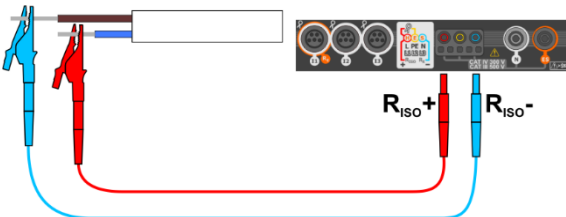

Connect test leads according to the drawing.

5



Trigger the measurement.

- **single measurement mode** – the measurement continues only when the user holds the START button,
- ↻ **continuous measurement mode** – the measurement is triggered by a short press of the START button and ends when START is pressed again.

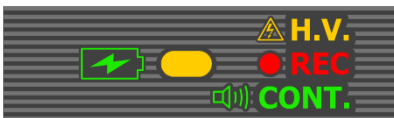

During the measurement the **H.V./REC/CONT.** diode is lit in **orange**.

6

13:16:03 | 2018-07-21

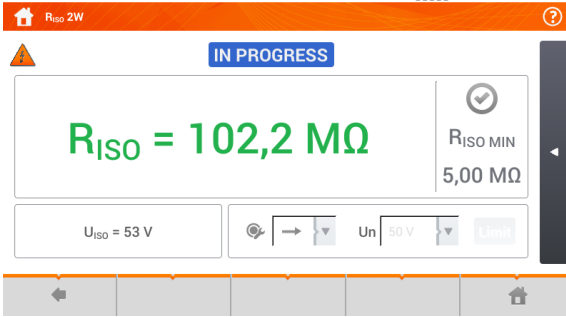

100 %

Read the measurement result.



Signal lights for reaching the limit (section 3.10.1 step 11)

- the result is within the set limit
- the result is outside the set limit
- assessment not possible

If continuous measurement has been selected (icon ) , the measurement can be stopped by selecting the  icon.



- The meter emits a continuous audio signal until test voltage reaches 90% of the pre-set value (and also when 110% of the preset value is exceeded).
- After completion of measurement, the capacitance of the object tested is discharged by shorting R_{ISO+} and R_{ISO-} terminals with resistance of 100 kΩ.

Additional information displayed by the meter

READY!	The meter is ready for measurement.
IN PROGRESS	Measurement in progress.
	Too high voltage detected on terminals of the meter. Disconnects the terminals from the test object.
NOISE!	Interference voltage occurs on the tested object. Measurement is possible but may be burdened with additional uncertainty.
LIMIT!	Current limit tripped. The symbol displayed during the measurement is accompanied by a continuous beep. If it is displayed after the measurement, it means that the measurement result was obtained during operation with a current limiting device (e.g. short circuit on the test object).

3.10.3 Measurements using UNI-Schuko adapter (WS-03 and WS-04)



WARNING

- During measurements of insulation resistance, dangerous voltage up to 500 V occurs at the ends of test leads of the meter.
- **It is forbidden** to disconnect test leads before the measurement is completed. Failure to obey the above instruction will lead to electric shock with high voltage and make it impossible to discharge the tested object.

1



Select item **R_{ISO}**, to call up the measurement menu.

2

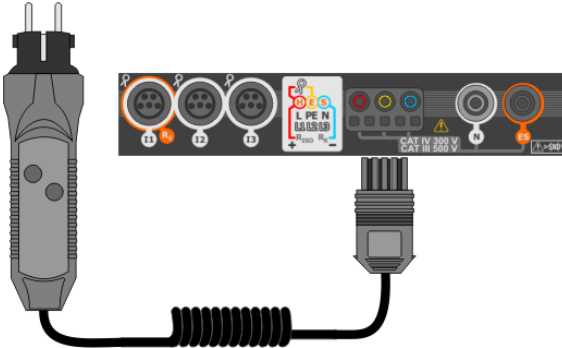

Connect **WS-03 adapter** or **WS-04 adapter** with UNI-Schuko outlet plug.

The meter detects this fact automatically and changes the appearance of the screen.

3

Enter the measurement settings in accordance with **section 3.10.1**

4

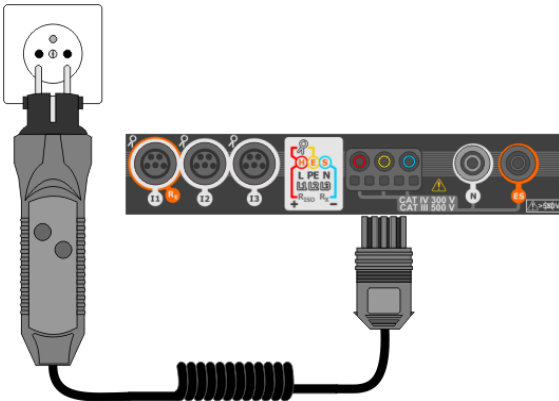

Connect the adapter to the test socket.

5

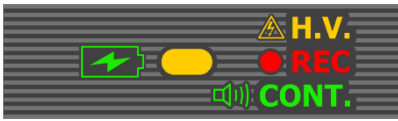

Press **START** to start measurement.

If any of the voltages exceeds allowable voltage value (50 V), **Object under voltage** message is displayed and the measurement is blocked.

During the measurement the **H.V./REC/CONT.** diode is lit in **orange**.

6

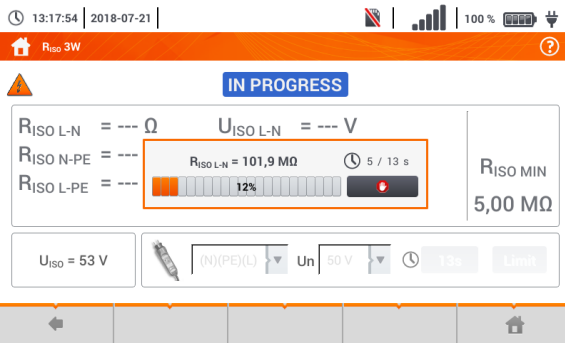

View of the screen during measurement.

The display shows the symbol of the resistance being measured and the progress bar of this measurement.

The progress bar indicates the status of the measurement.

The measurement may be cancelled at any time using the icon.

7

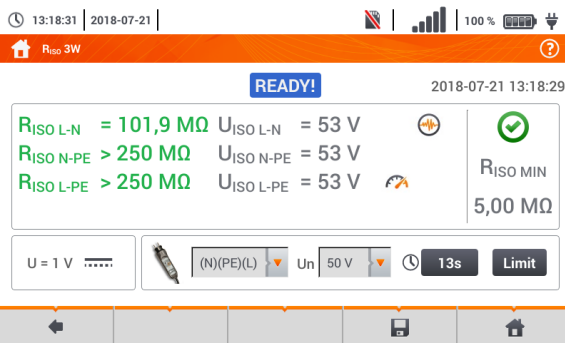

Read out the results.

Signal lights for reaching the limit (section 3.7.1 step 4)

- the result is within the set limit
- the result is outside the set limit
- assessment not possible

Additional signal lights for each of the measured lead pairs

- noise** – too strong interference signal recorded
- limit** – measurement taken at inverter current limit (e.g. short circuit in the test object)



8

Save the measurement to the meter memory using the icon. A detailed description of memory management is contained in **section 6.1.3**. The last measurement can be recalled using the icon.



- The meter emits a continuous audio signal until test voltage reaches 90% of the preset value (and also when 110% of the preset value is exceeded).
- After completion of measurement, the capacitance of the object tested is discharged by shorting R_{ISO+} and R_{ISO-} terminals with resistance of 100 k Ω .

Additional information displayed by the meter

READY!	The meter is ready for measurement.
IN PROGRESS	Measurement in progress.
	Too high voltage detected on terminals of the meter. Disconnects the terminals from the test object.
	Interference voltage occurs on the tested object. Measurement is possible but may be burdened with additional uncertainty.
	Current limit tripped. The symbol displayed during the measurement is accompanied by a continuous beep. If it is displayed after the measurement, it means that the measurement result was obtained during operation with a current limiting device (e.g. short circuit in the test object).

3.10.4 Measurements using AutoISO-1000c



WARNING

- During measurements of insulation resistance, dangerous voltage up to 1 kV occurs at the ends of test leads of the meter.
- **It is forbidden** to disconnect test leads before the measurement is completed. Failure to obey the above instruction will lead to **electric shock with high voltage** and make it impossible to discharge the tested object.

1



Select item **R_{ISO}**, to call up the measurement screen.

2

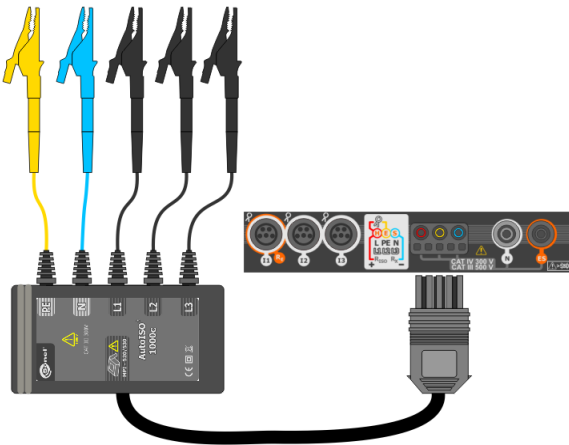

Connect **AutoISO-1000c** adapter.

The meter detects this fact automatically and changes the appearance of the screen.

3

Enter the measurement settings in accordance with **section 3.10.1**.

4



The meter is ready for measurement.

Live mode

U – interference voltage

Description of function icons

↓ scrolling down the list of measurements

↑ scrolling up the list of measurements

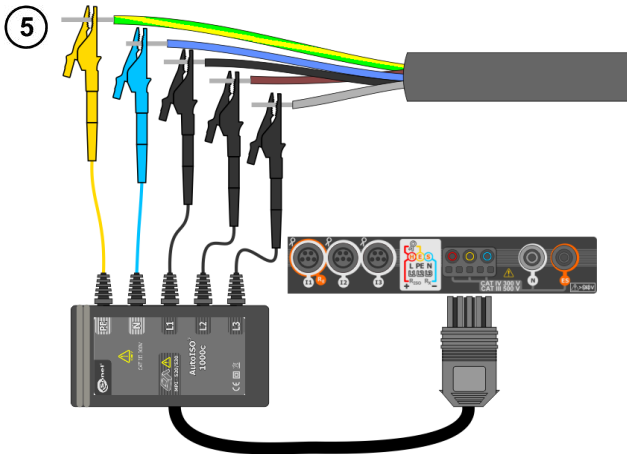

Connect AutoISO-1000c adapter to the lead tested.



Press **START** to start measurement.

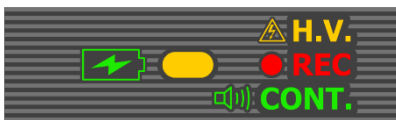

During the measurement the **H.V./REC/CONT.** diode is lit in **orange**.

If any of the voltages exceeds allowable voltage value (50 V), **Object under voltage** message is displayed and the measurement is blocked.

First, checking of voltages on particular pairs of wires is performed.

If any of the voltages exceeds allowable voltage, the symbol of this voltage is displayed (e.g. **VOLTAGE! L1PE**), and the measurement is interrupted.

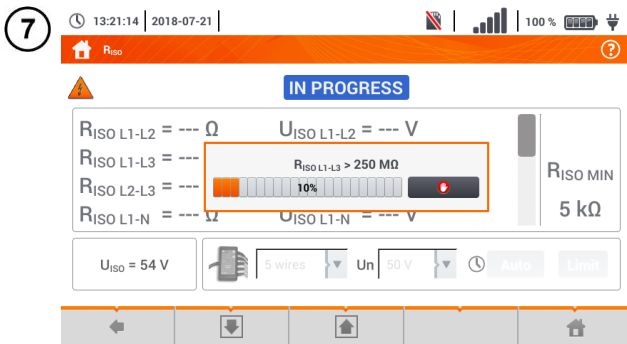

View of the screen during measurement.

The display shows the symbol of the resistance being measured and the progress bar of this measurement.

The bar shows % of progress of total measurement.

The measurement may be cancelled at any time using the  icon.

8

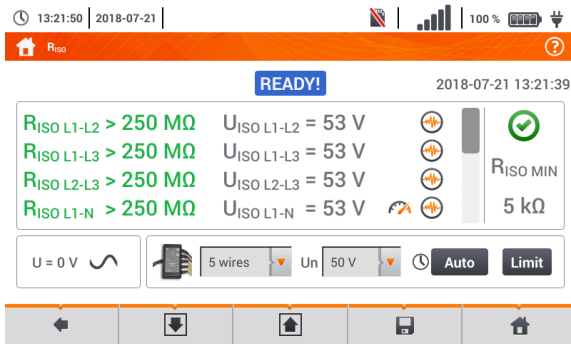

Read out the results.

Signal lights for reaching the limit (section 3.7.1 step 4)

- the result is within the set limit
- the result is outside the set limit
- assessment not possible

Additional signal lights for each of the measured lead pairs

- noise** – too strong interference signal recorded
- limit** – measurement taken at inverter current limit (e.g. short circuit in the test object)

9

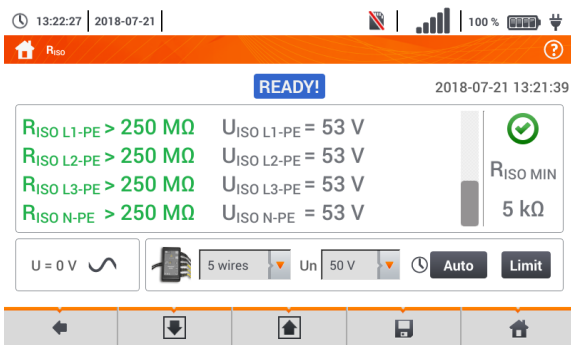

Using the slider or icons scroll the screen to read other measurement results.





10

Save the measurement to the meter memory using the icon. A detailed description of memory management is contained in **section 6.1.3**. The last measurement can be recalled using the icon.



- The meter emits a continuous audio signal until test voltage reaches 90% of the pre-set value (and also when 110% of the preset value is exceeded).
- After completion of measurement, the capacitance of the object tested is discharged by shorting R_{ISO+} and R_{ISO-} terminals with resistance of 100 kΩ.

Additional information displayed by the meter

	The meter is ready for measurement.
	Measurement in progress.
	Too high voltage detected on terminals of the meter. Disconnects the terminals from the test object.
	Interference voltage occurs on the tested object. Measurement is possible but may be burdened with additional uncertainty.
	Current limit tripped. The symbol displayed during the measurement is accompanied by a continuous beep. If it is displayed after the measurement, it means that the measurement result was obtained during operation with a current limiting device (e.g. short circuit in the test object).

3.11 Low-voltage resistance measurement

3.11.1 Resistance measurement

1



Select item R_x , to call up the measurement screen.

2



Select **Autozero** to eliminate the resistance of test leads.

3

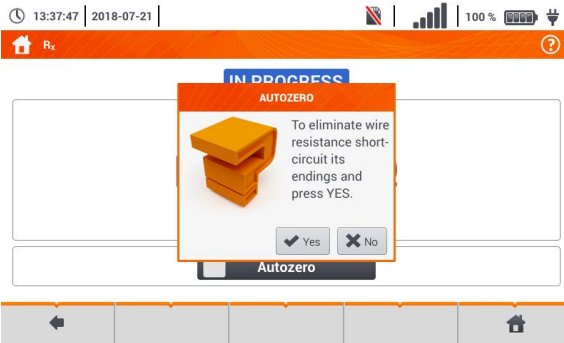

Follow the on-screen prompts.

Description of function icons

Yes – accept selection
No – cancels the action

After selecting **Yes** the meter will give the **result reduced** by the resistance of test leads.

4

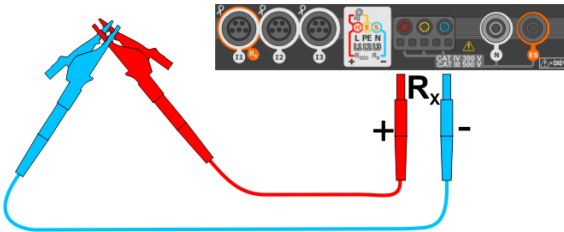

To **disable compensation** of the resistance of leads, repeat steps 2 3 4 with **open** test leads. Then the measurement result will **contain the resistance of test leads**.

5

13:41:12 | 2018-07-21 |



The meter is ready for measurement.



6

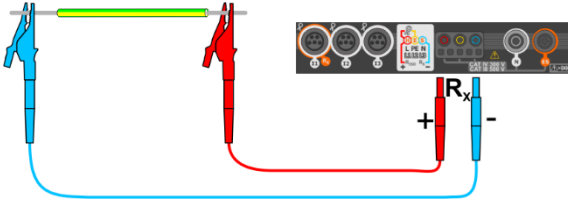

- Connect the meter to the tested object.
- Measurement starts automatically.

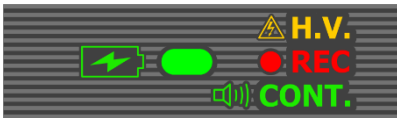

- During the measurement the **H.V./REC/CONT.** diode is lit green and a sound signal is emitted.

7

13:41:39 | 2018-07-21 |



Read out the result.

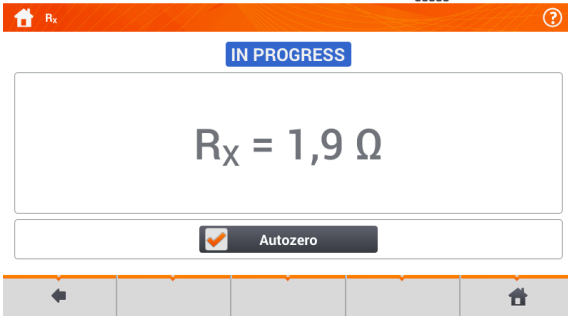

NOTE!

Display of symbols  **VOLTAGE!** indicates that the tested object is live. The measurement is blocked. The meter must be **immediately disconnected from the object.**



- If the **Autozero** option was **not deselected**, (steps ②③④), the meter invariably **reduces** the measurement result by the resistance of the previously connected test leads. Therefore, for each change of the leads, the **Autozero** procedure must be repeated.
- The correction factor is also remembered after restarting the function and/or the meter.
- If the test leads have been changed to such of a **lower** resistance than the previous ones but the **Autozero** procedure has not been performed, the meter will **understate** the value of the measurement. In extreme cases, the meter may indicate a **negative resistance**. Similarly, **greater** resistance of the leads causes an **overstated** result of the measurements.
- Maximum compensation of test leads resistance (Autozero) equals 500 Ω .

Additional information displayed by the meter

IN PROGRESS

Measurement in progress

VOLTAGE!

Incorrect voltage on object.

NOISE!

Interference voltage occurs on the tested object. The measurement is possible however it will be burdened with additional uncertainty that is specified in the technical data.

3.11.2 Measurement of resistance of protective conductors and equipotential bonding with ± 200 mA current

1



Select item **R_{CONT}**, to call up the measurement screen.

2

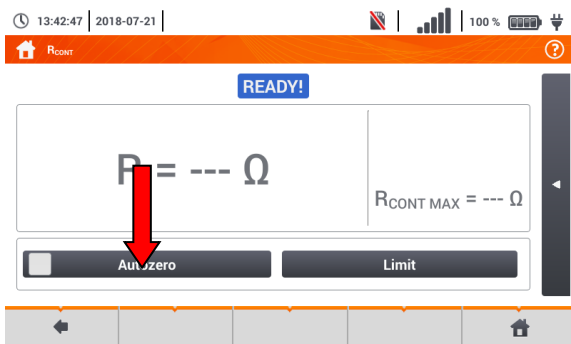

In order to eliminate the impact of the resistance of test leads on measurement result, the compensation (autozeroing) of resistance may be performed. For this purpose, select **Autozero**.

3



Follow the on-screen prompts.

Description of function icons

Yes – accept selection
No – cancels the action

After selecting **Yes** the meter will measure resistance of test leads 3 times. Then it will give the **result reduced** by this resistance.

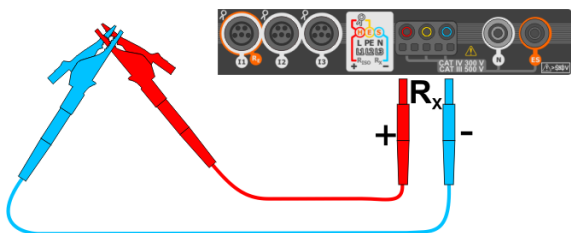

4

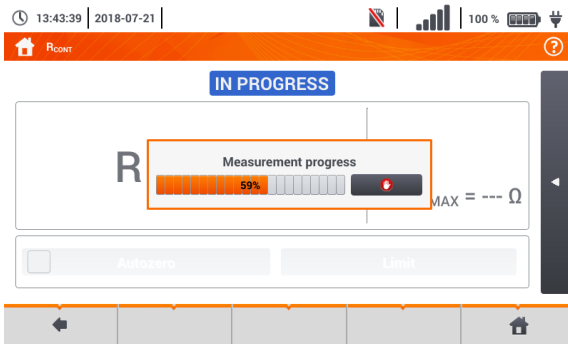

To **disable compensation** of the resistance of leads, repeat steps ② ③ with **open** test leads. Then the measurement result will **contain the resistance of test leads**.

5

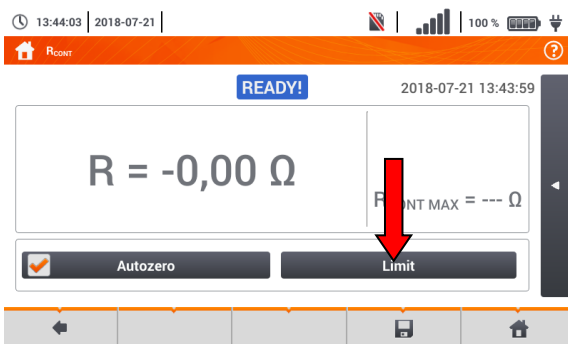

Set the acceptable limit resistance of the measured object.



6



Using the on-screen keyboard delete the existing value and enter the required one.

Range: 0...400 Ω

Functions of icons

-  reject changes and exit to the previous screen
-  accept changes

7

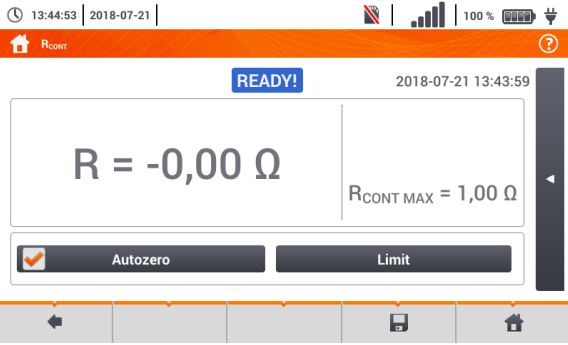

The meter is ready for measurement.

8

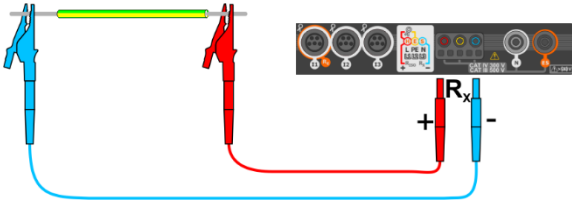

- Connect the meter to the tested object.
- Measurement starts automatically.

9

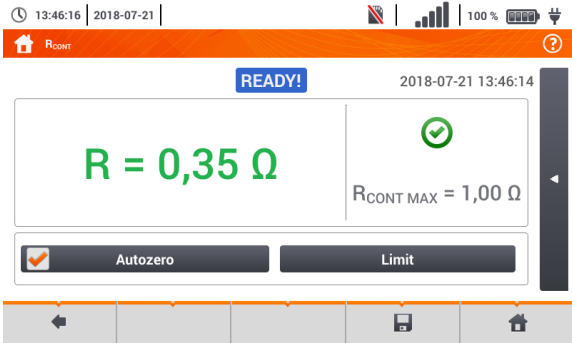

Read the measurement result.

The result is the arithmetic mean of the values of two measurements at a current of 200 mA with opposite polarities R_F and R_R .

$$R = \frac{R_F + R_R}{2}$$

Signal lights for the limit (step 5)

- ✔ the result is within the set limit
- ✘ the result is outside the set limit
- ⊖ assessment not possible

After selecting the bar  on the right side, a menu will slide out with additional measurement results.

10





R_F – result obtained for a **positive** polarity of the measuring current

R_R – result obtained for a **negative** polarity of the measuring current

Selecting the  bar hides the menu.

11

Save the measurement to the meter memory using the  icon. A detailed description of memory management is contained in **section 6.1.3**. The last measurement can be recalled using the  icon.

12



Press the **START** button in order to start the **next measurement** without disconnecting test leads from the object and proceed to step **8**.



NOTE!

Display of symbols  **VOLTAGE!** indicates that the tested object is live. The measurement is blocked. The meter must be **immediately disconnected from the object**.



- If the **Autozero** option was **not deselected**, (steps **2****3****4**), the meter invariably **reduces** the measurement result by the resistance of the connected test leads. Then, for each change of the leads, the **Autozero** procedure must be repeated.
- The correction factor is also remembered after restarting the function and/or the meter.
- If the test leads have been changed to such of a **lower** resistance than the previous ones but the **Autozero** procedure has not been performed, the meter will **understate** the value of the measurement. In extreme cases, the meter may indicate a **negative resistance**. Similarly, **greater** resistance of the leads causes an **overstated** result of the measurements.
- Maximum compensation of test leads resistance (Autozero) equals 500 Ω.

Additional information displayed by the meter

READY!	The meter is ready for measurement.
IN PROGRESS	Measurement in progress.
VOLTAGE!	Too high voltage on the tested object.
NOISE!	Interference voltage occurs on the tested object. The measurement is possible however it will be burdened with additional uncertainty that is specified in the technical data.

3.12 Phase sequence

1



Select item **Phase sequence**, to call up the measurement screen.

2 Connect the meter to the installation according to the drawing.

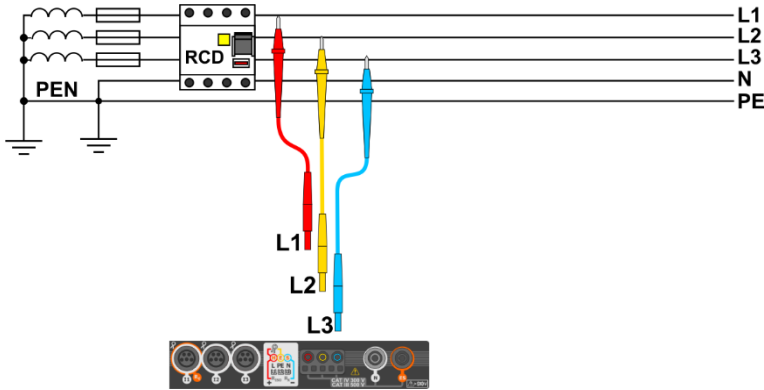

3



The meter ready for testing.

U_{L1-L2} , U_{L2-L3} , U_{L3-L1} values of phase-to-phase voltages

L1 **L2** **L3** signalling the presence of individual phases

4a

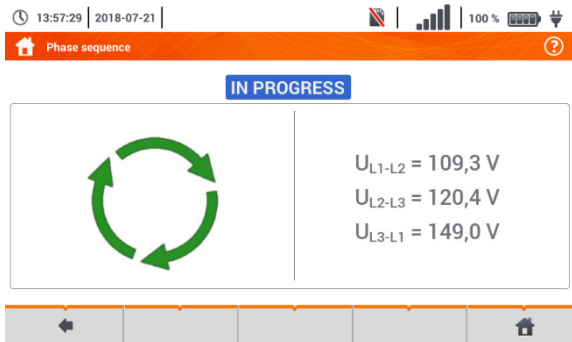

The phase sequence is **correct**, i.e. the phase sequence is in **clockwise** direction.

4b

13:58:39 | 2018-07-21 |



Phase sequence



IN PROGRESS

The phase sequence is **incorrect**, i.e. the phase sequence is in **anticlockwise** direction.

3.13 Motor rotation direction

1



Select item **Motor rotations**, to call up the measurement screen.

2

14:03:12 | 2018-07-21 |



Engine spin



IN PROGRESS

The meter ready for testing.

3

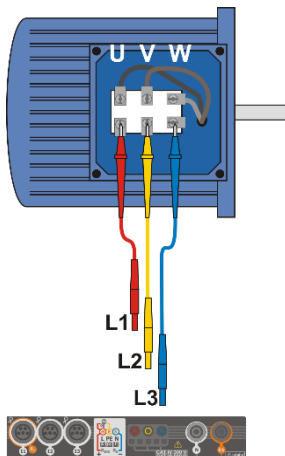

- Connect the meter to the motor according to the drawing, i.e. U terminal do input L1, V to L2, W to L3.
- Vigorously rotate the motor shaft to the right.

4a

14:03:18 | 2018-07-21



Engine spin

IN PROGRESS



Arrows on the screen rotating **to the right** mean that the motor connected to a 3-phase network will rotate the shaft **to the right**.

4b

14:08:12 | 2018-07-21



Engine spin

IN PROGRESS



Arrows on the screen rotating **to the left** mean that the motor connected to a 3-phase network will rotate the shaft **to the left**.



- Do not move the test leads during the test.
- Moving disconnected test leads, may induce voltages that result in indicating the direction of rotation.

3.14 Illuminance

1



Select item **Lux** to call up the measurement screen.

2



Connect the optical probe.

3

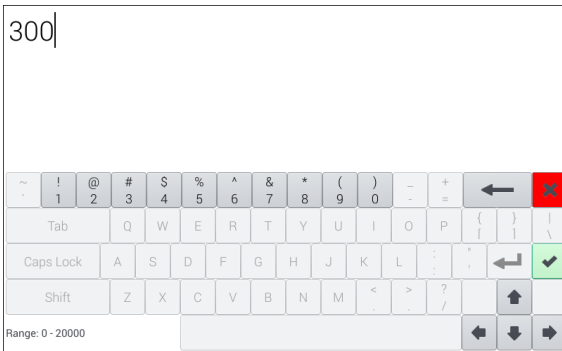

- Select **Limit** to set the criterion of minimum illuminance.
- Select unit.
- Delete the previous value and enter a new one from the range of 0...20 000 lx.

Functions of icons

- reject changes and exit to the previous screen
- accept changes

4

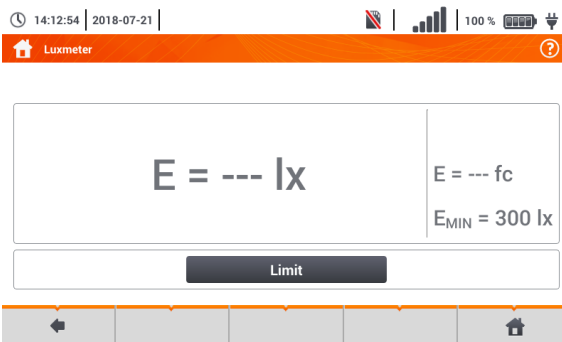

The meter is ready for light measurement.

Live mode

E [lx] – illumination expressed in lux (lm/m²)

E [fc] – illumination expressed in lm/ft² (lumen per square foot)

E_{MIN} – limit set in steps **3** **4**

5

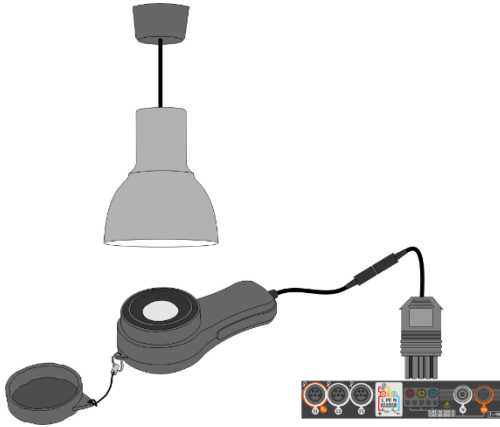

Place the probe in the test work plane.

6

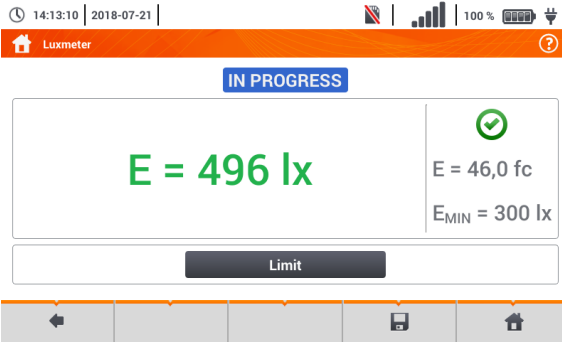

Read out the result.

Signal lights for the limit (step

3)

- the result is within the set limit
- the result is outside the set limit
- assessment not possible

7

Save the measurement to the meter memory using the icon. A detailed description of memory management is contained in **section 6.1.3**.

3.15 **MPI-540-PV** Resistance-to-earth (PV)



Connect the measuring system. The measurement is performed similarly as in **section 3.6**.

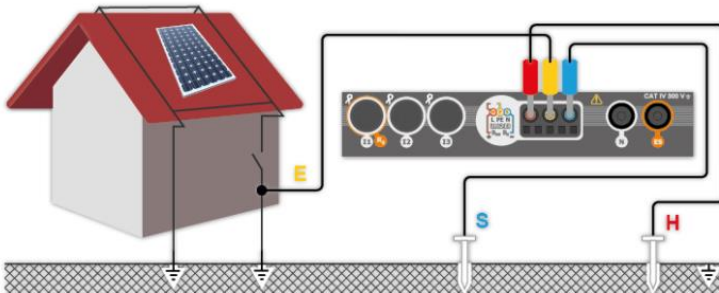

3.16 MPI-540-PV *Insulation resistance (PV)*



WARNING

- During measurements of insulation resistance, dangerous voltage up to 1 kV occurs at the ends of test leads of the meter.
- **It is forbidden** to disconnect test leads before the measurement is completed. Failure to obey the above instruction will lead to **electric shock with high voltage** and make it impossible to discharge the tested object.



The measurement is performed similarly as in **sec. 3.10**. Measure the insulation resistance between the positive pole (DC+) and grounding, as well as between the negative pole (DC-) and grounding. For this purpose:

- connect the grounding with R_{ISO-} socket of the meter, connect DC+ line with R_{ISO+} meter, select R_{ISO+} method in the instrument and start the measurement,
- connect DC- line with R_{ISO+} socket, select R_{ISO-} method in the instrument and start the measurement.

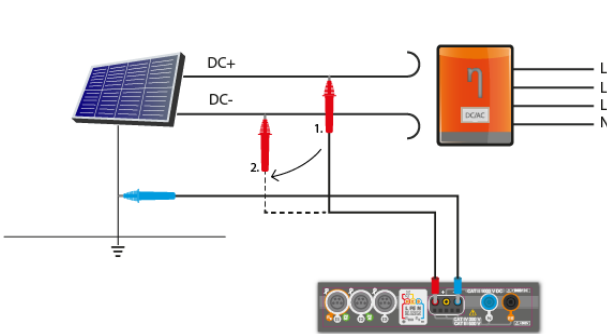

After selecting the bar ◀ on the right side, a menu will slide out with additional measurement results.

$U_{ISO\ L-N}$ – measurement voltage

Selecting the ▶ bar hides the menu.

3.17 MPI-540-PV *Continuity of connections (PV)*



Connect the measuring system. The measurement is performed similarly as in **sec. 3.11.2**.

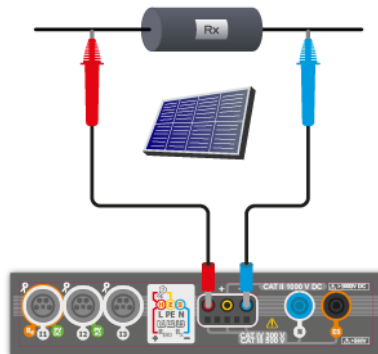

3.18 MPI-540-PV Open circuit DC voltage U_{OC}

1



Select item U_{OC} to call up the measurement screen.

2

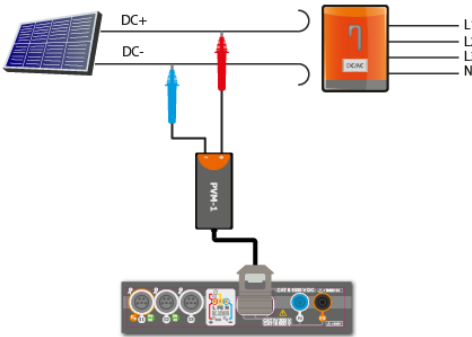

Turn off the inverter or disconnect it from the tested object. Connect the meter to the chain of PV modules using PVM-1 adapter and adapters of MC4 connectors. The following parameters will be measured:

U_{OC} – open circuit voltage,
 $U_{OC:STC}$ – open circuit voltage after conversion to STC* conditions,
 ΔU_{OC} – difference in open circuit voltage (measured and converted to STC conditions) and the same voltage declared by the producer of the panel, also converted to STC conditions.

*STC (Standard Test Conditions) – reference conditions, for which the manufacturer provides all the parameters of the modules.



WARNING

Do not disconnect MC4 connectors when the load current of working inverter flows through them. This may cause arcing and danger to the user!

3

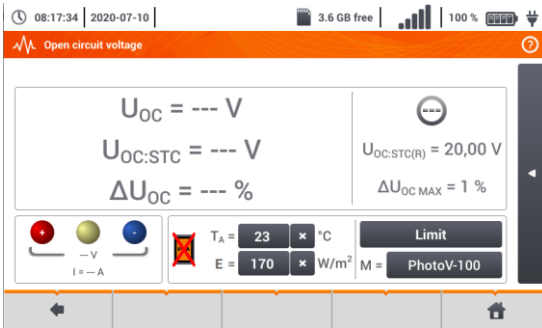

Enter the test parameters:

T_A – ambient temperature, if the source of temperature measurement = air (**sec. 2.2.1**),

T_{PV} – module temperature, if the source of temperature measurement = module (**sec. 2.2.1**),

E – irradiance,

Limit – setting of $\Delta U_{OC MAX}$ values,

M – photovoltaic module selected from the meter database (**sec. 2.2.3**).

In addition, the screen displays the following:

$U_{OC:STC(R)}$ – open circuit voltage in STC conditions, declared by the manufacturer,

$\Delta U_{OC MAX}$ – limit ΔU_{OC} set.



Parameters T_A , T_{PV} , E come from the irradiance meter, if it is connected to the meter. See also **sec. 3.22**.

4



Press **START** to start the measurement.

5

Signal lights for the limit (step 3)

- the result is within the set limit
- the result is outside the set limit
- assessment not possible

After selecting bar, a pop-up menu is displayed on the right side of the screen, containing the parameters of the measured PV object.

M – number of modules in series,

N – number of modules connected in parallel,

T_{PV} – temperature of the module.

Selecting the bar hides the menu.

3.19 MPI-540-PV Short circuit DC current I_{sc}

1



Select item I_{sc} , to call up the measurement screen. Then reset the clamp (sec. 3.21).

2

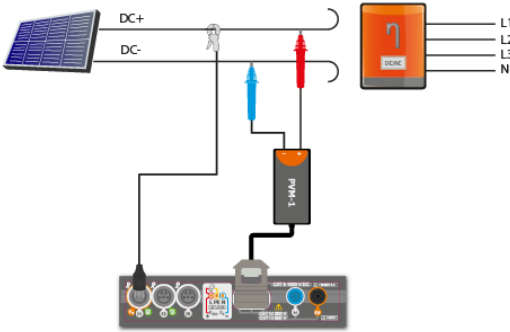

Turn off the inverter or disconnect it from the tested object. Connect the meter to the chain of PV modules using PVM-1 adapter and adapters of MC4 connectors. The following parameters will be measured:

- I_{sc} – short-circuit current
- $I_{sc:STC}$ – short circuit current after conversion for STC* conditions,
- ΔI_{sc} – difference of short-circuit current (measured and converted to STC conditions) and the same current declared by the producer of the panel, also converted to STC.

*STC (Standard Test Conditions) – reference conditions, for which the manufacturer provides all the parameters of the modules.



WARNING

Do not disconnect MC4 connectors when the load current of working inverter flows through them. This may cause arcing and danger to the user!

3



Enter the test parameters:

- T_A – ambient temperature, if the source temperature measurement = air (sec. 2.2.1),
- T_{PV} – module temperature, if the source of temperature measurement = module (sec. 2.2.1),
- E – irradiance,
- Limit** – setting of $\Delta I_{sc \text{ MAX}}$ values,
- M** – photovoltaic module selected from the meter database (sec. 2.2.3).

In addition, the screen displays the following:

- $I_{sc:STC(R)}$ – short-circuit current in STC conditions, as declared by the manufacturer,
- $\Delta I_{sc \text{ MAX}}$ – limit ΔI_{sc} set.



Parameters T_A , T_{PV} , E come from the irradiance meter, if it is connected to the meter. See also sec. 3.22.

4



If necessary, reset the clamps again. Press **START** to start the measurement.

5

Signal lights for the limit (step 3)

- the result is within the set limit
- the result is outside the set limit
- assessment not possible

After selecting bar, a pop-up menu is displayed on the right side of the screen, containing the parameters of the measured PV object.

- M** – number of modules in series,
 - N** – number of modules connected in parallel,
 - T_{PV} – temperature of the module.
- Selecting the bar hides the menu.

3.20 MPI-540-PV Test of the inverter panel η , P , I

1



Select item η , P , I , to call up the measurement screen. Then reset the clamps (sec. 3.21).

2

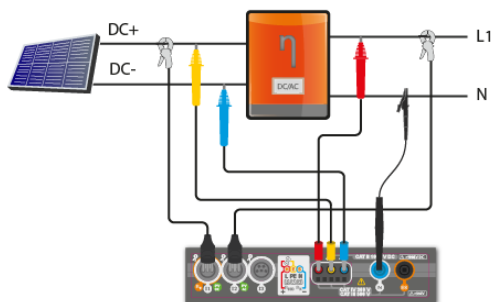

Connect the meter to the tested object. The following parameters will be measured:

- at the inverter input (DC)
- at the inverter output (AC).

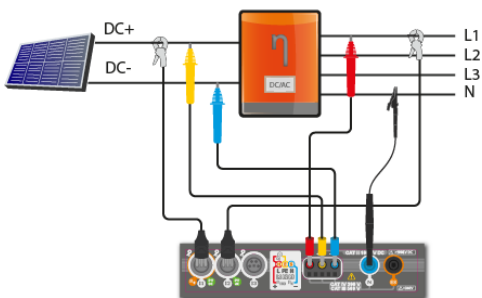

◀ In the case of 3-phase inverter, the measurement is made assuming the symmetry of the output currents and voltages on the AC side.

3

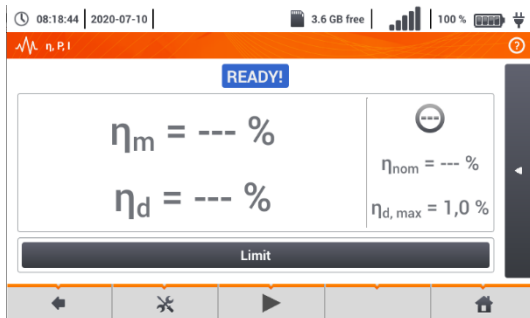

You may use icon, to select the data presented on the screen.

- ⇒ currents at input (I_{DC}) and output (I_{AC}),
- ⇒ power values at input (P_{DC}) and output (P_{AC}),
- ⇒ inverter efficiency (η_m) and the difference between the efficiencies of the inverter: measured and declared by the manufacturer (η_d).

Select **Limit**, to set the criterion of the maximum difference between the efficiencies of the inverter: measured and declared by the manufacturer.

If necessary, reset the clamp again.

Use icon to go to the measurement configuration. See sec. 3.20.1, 3.20.2.

4



Press **START**. The live mode readings will be captured and displayed in the main screen.

5 Signal lights for the limit (step 3)

- the result is within the set limit
- the result is outside the set limit
- assessment not possible

After selecting the bar on the right side, a menu will slide out with additional measurement results.

η_m – the efficiency value of the inverter as the ratio of the active power of AC side to active power of DC side

η_{nom} – efficiency of the inverter declared by the manufacturer

η_d – difference between the efficiencies of the inverter: measured and declared by the manufacturer

U_{AC} – voltage measured on AC side

U_{DC} – voltage measured on DC side

I_{AC} – current measured on AC side

I_{DC} – current measured on DC side

Selecting the bar hides the menu.

3.20.1 Measurement configuration

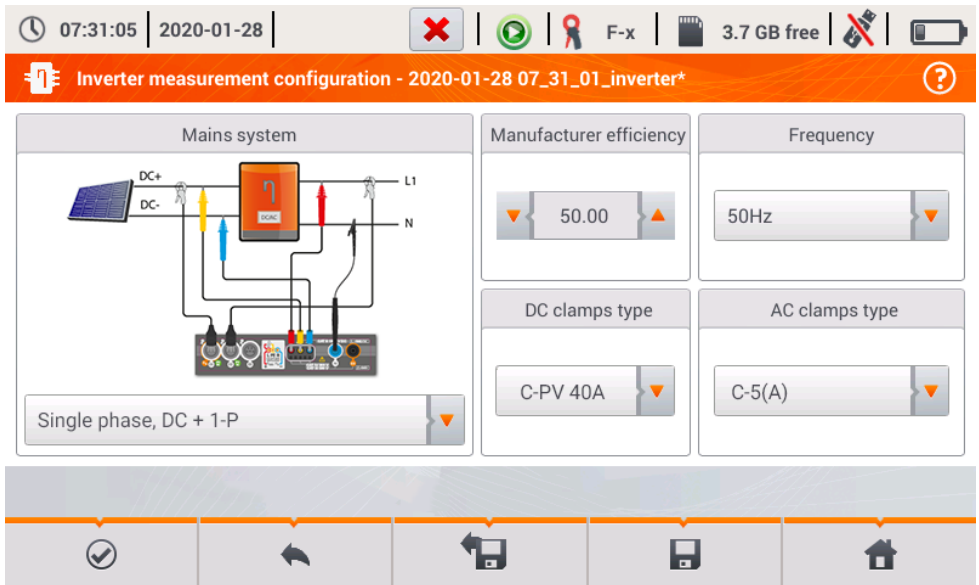

Fig. 3.10. Configuration screen of inverter efficiency measurement

Set the parameters of the tested inverter on the displayed configuration screen:

- **Mains system** – there are two types to choose from:
 - **Single phase, DC + 1-P**

Select this system type for inverters with single-phase AC output. The screen will show a simplified diagram of the meter connection to the tested circuit:

 - DC+ voltage input of the inverter must be connected to L2 input of the meter
 - DC- input of the inverter must be connected to L3 input,
 - AC voltage side of the inverter must be connected to inputs: L1 (phase wire) and N (neutral wire),
 - current of DC side of the inverter is measured with DC clamps connected to I1 input of the clamps.



It is necessary to use clamps for DC measurements

- current of AC side of the inverter is measured with clamps connected to I2 input of the meter. The user may specify any type of clamps compatible with the meter.
- **Three phase, DC + 4-P**

It is possible to measure only the efficiency of three-phase, 4-wire inverters (star configuration with neutral wire). Please note that due to the limited number of voltage inputs in the meter, it is not possible to directly measure all phase-to-phase voltages. Therefore, the measured parameters on AC side are presented as approximate values, with accuracy depending on the symmetry of the output voltages and currents of the inverter. If it works in such systems, verify voltage asymmetry before the efficiency measurement (negative sequence unbalance U_2/U_1 should be less than 1%). This verification should be carried out by configuring and connecting the meter in a standard way to a three-phase network 4-P (**sec. 5.6.3, 5.6.4**).

How to connect the meter:

- DC+ voltage input of the inverter must be connected to L2 input of the meter
- DC- input of the inverter must be connected to L3 input,
- AC voltage side of the inverter must be connected to inputs: L1 (phase wire) and N (neutral wire),
- current of DC side of the inverter is measured with DC clamps connected to I1 input of the clamps.









It is necessary to use clamps for DC measurements

- current of AC side of the inverter is measured with clamps connected to I2 input of the meter. The user may specify any type of clamps compatible with the meter.
- **Manufacturer efficiency** – efficiency of the inverter declared by the manufacturer. This value is used to compare the measured efficiency with the declared value.
- **DC clamps type** – the user may use the list to select the type of clamps used for current measurements on DC side of the inverter.
- **AC clamps type** – the user may use the list to select the type of clamps used for current measurements on AC side of the inverter.
- **Frequency** – nominal frequency of the AC output of the inverter.

After setting the required parameters, you can go directly to the required measurements.

Menu bar functions

-  entering the measurement screen (live values in a tabular view) with the specified settings (without saving the configuration).
-  saving the configuration of inverter efficiency to a file with an option to start the measurement directly after saving (field **Go to Live mode** in the pop-up window).
-  entering the list of saved configurations of inverter efficiency and creating a new configuration. Configurations are presented similarly to the measuring configurations, they have their own icon . Double-tap on a selected configuration will open it automatically and entering the screen with inverter efficiency settings (**Fig. 3.11**). The button in the menu bar  is used for adding new configurations starting of the inrush current (a window is displayed, as shown in **Fig. 3.12** with default settings). Icon  is used to edit the chosen configuration.

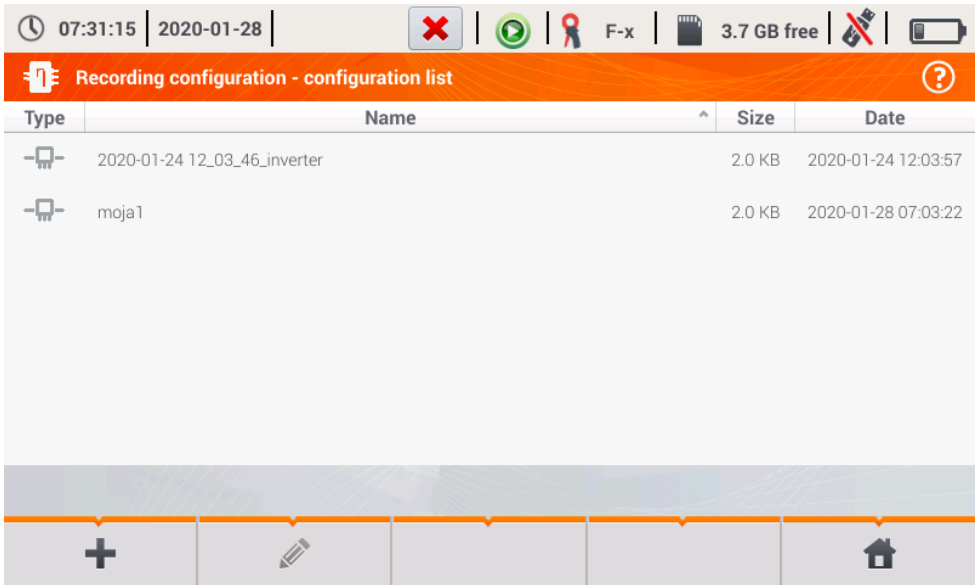

Fig. 3.11. Menu of recording configuration

3.20.2 Live mode

After entering the live mode screen, all the parameters of the measured inverter circuit are shown in a tabular view.

	η_m [%]	η_d [%]	U [V]	U_{ho1} [V]	U_{DC} [mV]	f [Hz]	I [A]
AC/DC	16.03	33.97	---	---	---	---	---
DC	---	---	3.282	---	-3.235	---	1.464
L1	---	---	0.057	---	14.73	0.000	0.624
L2	---	---	---	---	---	---	---
L3	---	---	---	---	---	---	---
N	---	---	---	---	---	---	---
L1-2	---	---	---	---	---	---	---
L2-3	---	---	---	---	---	---	---

Fig. 3.12. Live mode in tabular view for the inverter efficiency measurement mode

- **AC/DC** line:
 - column η_m displays the efficiency value η_m of the inverter as the ratio of the active power of AC side to active power of DC side:

$$\eta_m[\%] = \frac{P_{AC}[W]}{P_{DC}[W]} \cdot 100\%$$

- column η_d shows the difference between the measured and declared efficiency of the inverter:

$$\eta_d[\%] = \eta_{nom}[\%] - \eta_m[\%]$$

where η_{nom} is the declared efficiency of the inverter entered to the configuration screen.

- line **DC** presents the parameters of DC side of the inverter such as voltage, current, active power, active energy.
- values related to AC side are displayed in lines: **L1** and **Σ**.

3.21 **MPI-540-PV** *Resetting C-PV clamp*

Before the I_{SC} measurement and testing the inverter (**sec. 3.19, 3.20**) reset C-PV clamp. To do this, connect the clamp to the meter. Set the **DC ZERO** knob on the housing of the clamp to make the voltage and current readings as close to zero as possible. Only then you can connect the clamp to the tested object.

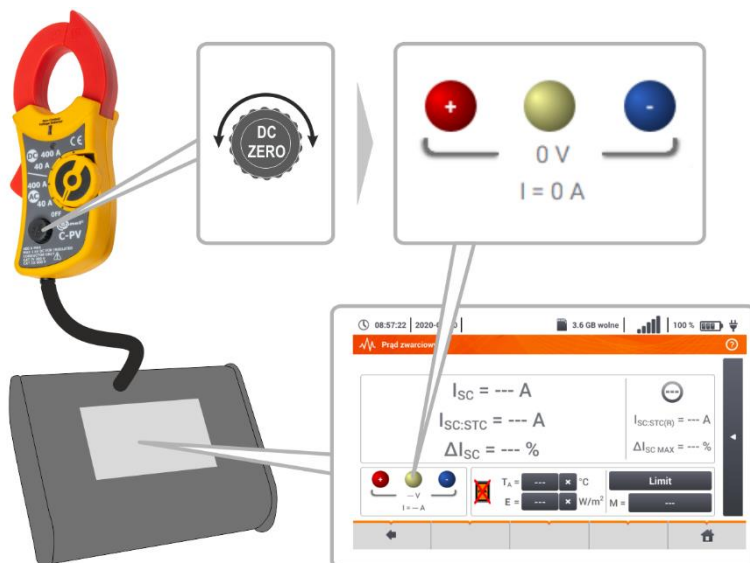

3.22 **MPI-540-PV** *Irradiance and temperature*

1 Pair the instrument and the irradiance meter according to **sec. 2.3.3**.



Select item **Irr**, to display the measurement screen.



Connect the irradiance meter to the tested object. The screen shows the current readings:

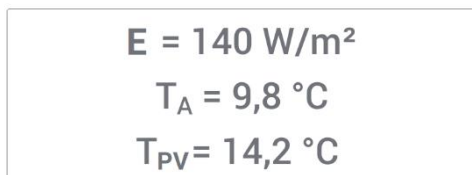

E – irradiance,
T_A – ambient temperature,
T_{PV} – PV module temperature.

4 Auto measurements

The meter includes automated test procedures.

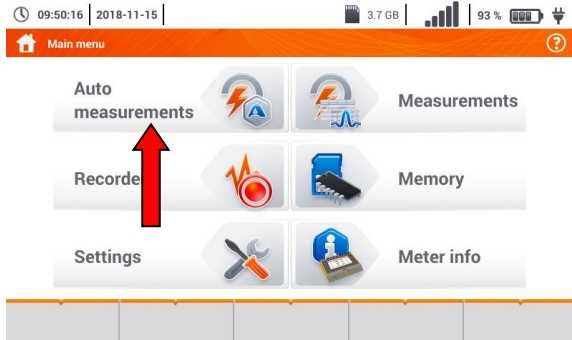

4.1 Proceeding auto measurements

1

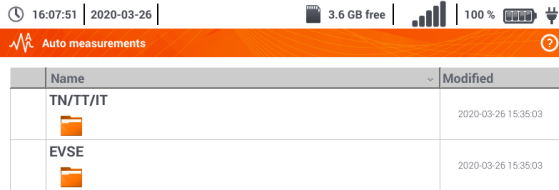

The measurement sequences are grouped into two folders:
 ⇒ measurements in TN/TT/IT networks,
 ⇒ measurements dedicated for electric vehicles charging stations.

Select the measuring sequence from the list.

2



Connect the meter to the measuring system.

In each setting field, enter the type of measuring accessory, installation parameters and other required data.

Description of function icons

- assistance for a particular measurement
- collapsing setting fields
- expanding setting fields
- saving entered measurement data

3



Press **START**. The automatic measurement sequence will start.

4



◀ The screen after completion of one of sequence measurements.

Description of function icons

- stopping the procedure and going to summary
- ↺ repeating the measurement with overwriting its result
- ↻ repeating the measurement without losing its previous result
- ⏸ stopping the procedure
- ▶▶ going to the next step of the procedure or to the summary. Time remaining to the next step is set according to **sec. 2.2.1.**

5



◀ Summary screen.

The procedure can be restarted with the ↺ icon.

Each measurement in a sequence hides partial results. To call them, touch the **label of such measurement**. A window as for a single measurement will be opened. Enter it with the use of the ◀ icon.

Save the measurement to the meter memory using the 💾 icon. A detailed description of memory management is contained in **section 6.1.3.**

6

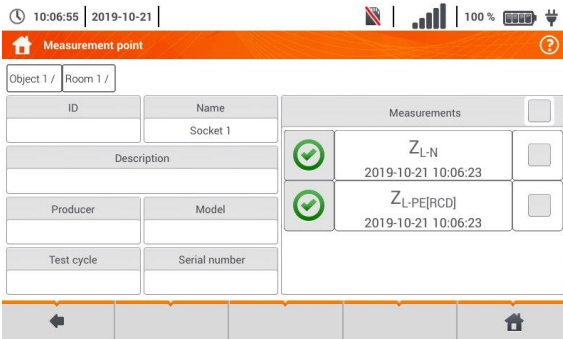

All sequence measurements will be saved in one measuring point.

Signal lights for reaching the limit

- ✔ the result is within the set limit
- ✘ the result is outside the set limit
- ⋯ assessment not possible
- ⊘ no measurement was made

4.2 Creating measurement procedures

1

Name	Modified
TN/TT/IT	2020-03-26 15:35:03
EVSE	2020-03-26 15:35:03

- Select **+**, to go to the sequence wizard.

- Select **+**, to add the desired measurement procedure.



2



From the available items select the one, which is to be a part of the procedure. In addition to standard measurements, the following are also available:

- ⇒ text message,
- ⇒ visual test.

3



After each selection, the menu with step parameters will be shown.

If the tests contain measurements in electric vehicle charging stations, then **EV** box should be selected.

Description of function icons

- assistance for a particular measurement
- collapsing setting fields
- expanding setting fields
- saving entered measurement data

4



- Changing the order of the steps is performed by using icons. Delete the step by using icon.

- Save the procedure by using icon. A window will be shown requesting the name of the procedure.

5

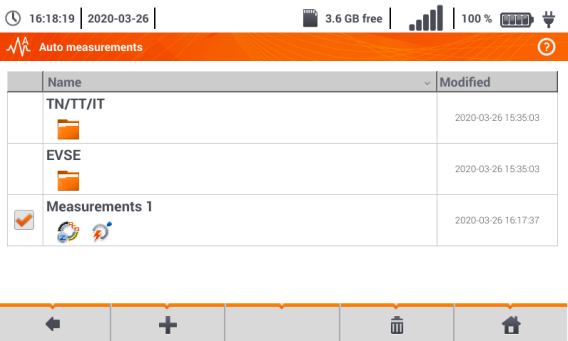

The procedure will be available from the main menu of auto-procedures. To remove it, select it with and choose .

5 Recorder

5.1 Functional Description

MPI-540 meter can be used as a 3-phase recorder of power supply parameters. It allows measurement and recording of parameters of 50/60 Hz power networks such as voltage, current, power, harmonics values, etc. To switch to the meter to power supply quality analyzer mode, select **Recorder** on the main screen.

In this mode it is possible to view the current network parameters (i.a. waveforms, component vectors, tabular data), recording of average parameter values according to the user settings and analysis of the recorded data (time diagrams, harmonics, etc.).

The analyzer module uses the following input sockets of the meter:

- three sockets of **current** clamps I1, I2, I3,
- three **voltage** banana sockets L1, L2, L3 in the multifunctional socket, to which individual voltage phases are connected (max. 550 V relative to earth),
- separate banana socket marked N.



Fig. 5.1 Measuring inputs

Four sockets for current clamps allow the user to connect several types of clamps to measure currents. The following clamps may be connected to them:

- flexible clamps F-1A, F-2A, F-3A of nominal range of 3000 A AC (different only in terms of the coil perimeter),
- CT clamps: C-4A (range 1000 A AC), C-5A (range 1000 A AC/DC), C-6A (range 10 A AC) and C-7A (range 100 A AC).

The measuring range may be changed by using additional transducers – for example, using a transducer of 10 000 A / 5 A with C-6A clamps the user may measure currents up to 10 000 A.

The recorded data is stored on a removable microSD memory card. The meter also has an internal memory, which is used for storing i.a. configuration files. A detailed description of memory management is contained in **section 5.5.3**.

Configuration of the recorder consists in that the user only sets the basic parameters: type of network, type of clamps, frequency, averaging period. All data that the meter is able to measure is always recorded. All parameters of the power supply network measured by the meter in the recorder mode are listed below:

- RMS voltage,
- DC components of voltages,
- RMS currents,
- DC components of currents (only using C-5A clamps),
- mains frequency within the range of 40..70 Hz,
- harmonics of voltages and currents (up to 40th),

- total harmonic distortion (THD) THD_F for currents and voltages,
- active, reactive, apparent and distortion power,
- active positive and negative energies,
- passive energies consumed and returned,
- apparent energies,
- power factors (PF)
- unbalance factors of voltages and currents

Some of the parameters are aggregated (averaged) according to the time selected by the user (available settings: 1 s, 3 s, 10 s, 30 s, 1 min, 10 min, 15 min, 30 min) and may be stored on a memory card.

The meter is compatible with PC software *Sonel Analysis*, which also supports other analyzers produced by Sonel. This software allows analysis of the recorded data. The data may be read using the USB cable or directly from a microSD card after inserting it to an external memory card reader connected to PC.

Tab. 5.1 presents a summary of parameters measured by MPI-540, depending on the mains type.

Tab. 5.1. Measured parameters for different network configurations

Parameter / Network type, channel		1-phase		2-phase				3-phase 4-wire					3-phase 3-wire			
		L1	N	L1	L2	N	Σ	L1	L2	L3	N	Σ	L12	L23	L31	Σ
U	Effective voltage	•		•	•	•		•	•	•			•	•	•	
U _{DC}	Voltage constant component	•		•	•	•		•	•	•			•	•	•	
I	Effective current	•		•	•	•		•	•	•	•		•	•	•	
I _{DC}	Current constant component	•	•	•	•	•		•	•	•	•		•	•	•	
F	Frequency	•		•				•					•			
P	Active power	•		•	•	•	•	•	•	•	•	•				
Q ₁	Reactive power	•		•	•	•	•	•	•	•	•	•				• ⁽¹⁾
D, S _N	Distortion power	•		•	•	•	•	•	•	•	•	•				
S	Apparent power	•		•	•	•	•	•	•	•	•	•				•
PF	Power Factor	•		•	•	•	•	•	•	•	•	•				•
tanφ	Factor tangent φ	•		•	•	•	•	•	•	•	•	•				• ⁽¹⁾
THD _F U	Total harmonic distortion voltage	•		•	•	•		•	•	•			•	•	•	
THD _F I	Total harmonic distortion current	•	•	•	•	•		•	•	•	•		•	•	•	
E _{P+} , E _{P-}	Active energy (consumed and supplied)	•		•	•	•	•	•	•	•	•	•				•
E _{Q1+} , E _{Q1-} , E _{OB+} , E _{OB-}	Reactive energy (consumed and supplied)	•		•	•	•	•	•	•	•	•	•				• ⁽¹⁾
E _S	Apparent energy	•		•	•	•	•	•	•	•	•	•				•
U _{h1..h40}	Voltage harmonic amplitudes	•		•	•	•		•	•	•			•	•	•	
I _{h1..h40}	Current harmonic amplitudes	•	•	•	•	•		•	•	•	•		•	•	•	
Unbalance U, I	Symmetrical components and unbalance factors												•			•

Explanations: L1, L2, L3 (L12, L23, L31) indicate subsequent phases,

N is a measurement of I_N current depending on the parameter type,

Σ is the total value for the system.

(1) In 3-wire networks, the total reactive power is calculated as inactive power N.

(2) Only consumed energy E_{P+}.



- During recording the **HV LED / REC / CONT.** diode flashes **red** at 2-second intervals.
- In order to avoid ambiguity in the calculating power values, attach clamps with their arrows indicating the point of connecting L terminal of the meter to the tested object.
- If they are attached in the other direction, an appropriate correction may be introduced in the meter before recording starts (**section 5.5.1**).

5.2 Main elements of the screen

After entering the recorder mode the **Main menu** is displayed. It is available:

- after switching the meter on,
- at any time after the  icon has been selected on the display.

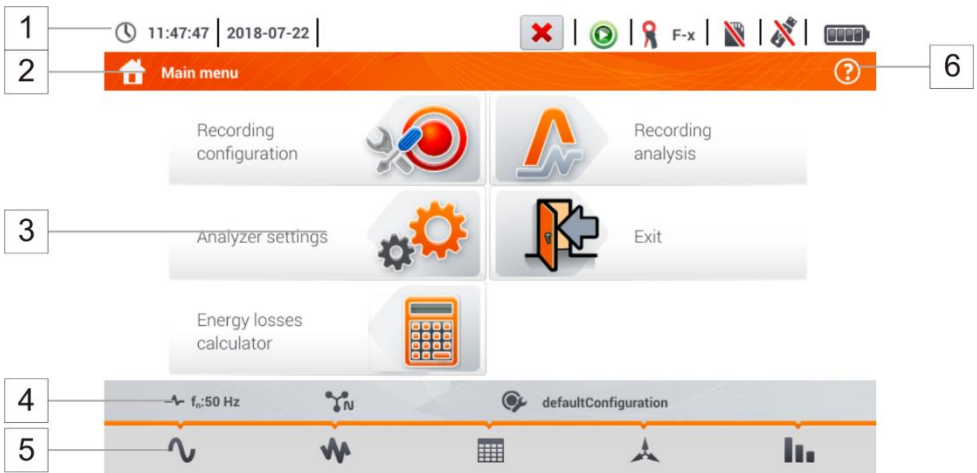

Fig. 5.2 Main elements of the recorder screen

1 Top bar

2 Name of the active menu

The fact of introducing a change that has not been saved yet is indicated by the * symbol in the screen header.



3 Main window

4 Information bar on current network configuration ,

5 Function icons bar

6 Active menu help

- Visualisation of connection systems
- Explanation of icons

5.2.1 Top bar

At the top of the screen there is a bar with status controls (Fig. 5.3).

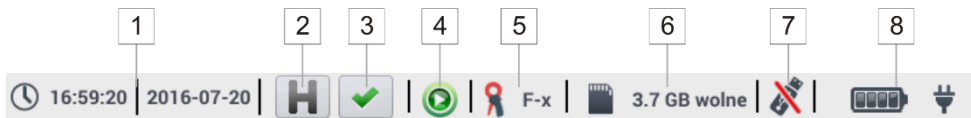





Fig. 5.3. Elements of the top bar

1 Current time and date



2 HOLD function control

Selecting this icon on the screens of LIVE mode (preview of the current network, see **sec. 5.6**) will stop the refreshing of image displayed in the main window. Press it again to return to normal mode.

3 Verifying the connection control

The icon on this button informs the user about the correctness or potential problem with the configuration or connection of the recorder (symbols ,  or  may be displayed). Pressing this icon will display a window with more detailed information about possible errors in connecting the recorder to the mains and with the compliance of mains parameters with the current measurement configuration. More information can be found in **section 5.3.2**.

4 Recording status icon

-  recording inactive
-  recording active

5 Information on connected or configured current clamps

- If the measurement configuration has **no clamps indicated** - the field displays **dashes "---**".
- When a **specific type of clamps** is selected, their **name** will be displayed.

6 Memory card icon with information about free space

If the card is not in the slot, the icon on the screen is crossed out.

7 USB external memory icon (flash drive)

If no external memory is connected, the icon is crossed out.

8 The icon of battery charge status and mains power supply

5.2.2 Title bar

The title bar (Fig. 5.2, element 2) displays the name of the current main window with the name of the section. It allows the user to quickly see which part of the interface is displayed.

5.2.3 Main window

In the central part of the screen, the main window of the recorder is displayed. The default window (shown in Fig. 5.2) contains the following items:





- **Recording configuration** – this part of the interface is used to configure the measurement system and all aspects related to the recording of network parameters such as: network type (e.g. single-phase, three-phase) or clamps type (**section 5.4**),
- **Recording analysis** – provides an analysis of the recorded data and 'live' view of the recording process (**section 5.7**),
- **Analyzer settings** – a series of the recorder configuration options can be found here (more: **section 5.5**),
- **Energy loss calculator** – in this mode the user can estimate financial losses due to poor quality of power supply,
- **Exit** – go to the main menu.

5.2.4 Information bar on the parameters of the current network

Below the main screen a bar is displayed, which shows the main parameters of the active measurement system (Fig. 5.2, element 4):

- nominal voltage,
- network frequency,
- network layout,
- name of the current recording configuration.

The network layout is symbolized by icons:

-  1-phase system,
-  2-phase system,
-  3-phase 4-wire system,
-  3-phase 3-wire system,
-  3-phase 3-wire system with the measurement of currents using Aron's method,

5.2.5 Help

On the right side of the title bar the help icon  is seen (Fig. 5.2, element 6). After its selection, a context help is displayed, which describes interface elements visible on the screen.

5.3 Connecting the measuring system

5.3.1 Measuring arrangements

The recorder may be connected directly to the following types of AC networks:

- single-phase (Fig. 5.4)
- 2-phase (split-phase) with split-winding of the transformer) (Fig. 5.5),
- 3-phase 4-wire (Fig. 5.6),
- 3-phase 3-wire (Fig. 5.7 ,Fig. 5.8).

In three-wire AC systems, current may be measured by the Aron method (Fig. 5.8), which uses only two clamps that measure linear currents I_{L1} and I_{L3} . I_{L2} current is then calculated using the following formula:

$$I_{L2} = -I_{L1} - I_{L3}$$

Pay attention to the direction of current clamps (flexible and hard). The clamps should be installed with the indicating the load direction. It may be verified by conducting an active power measurement - in most types of passive receivers active power is positive. When clamps are inversely connected, it is possible to change their polarity using in software (**Analyzer settings**→ **Clamps**)

The following figures show schematically how to connect the analyzer to the tested network depending on its type.

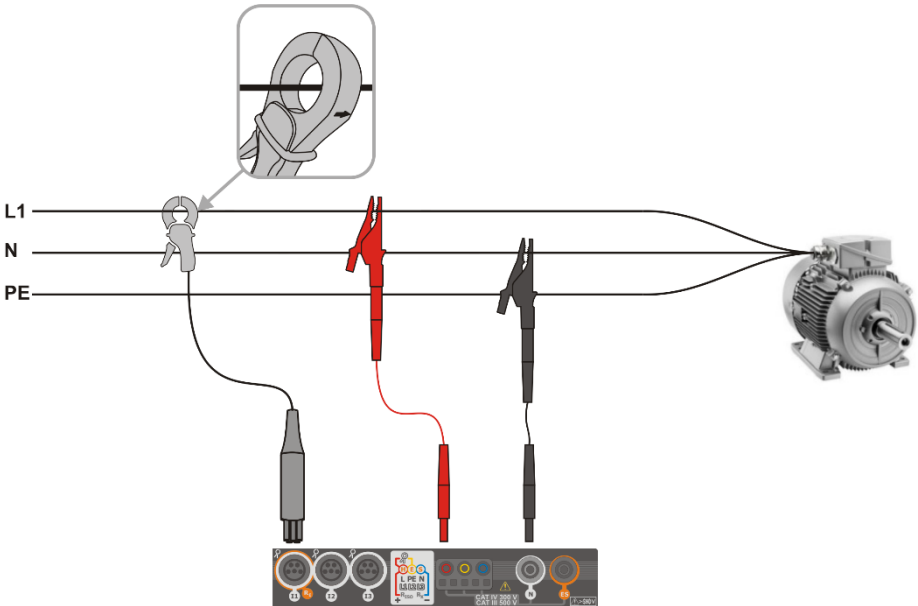

Fig. 5.4 Wiring diagram – single phase

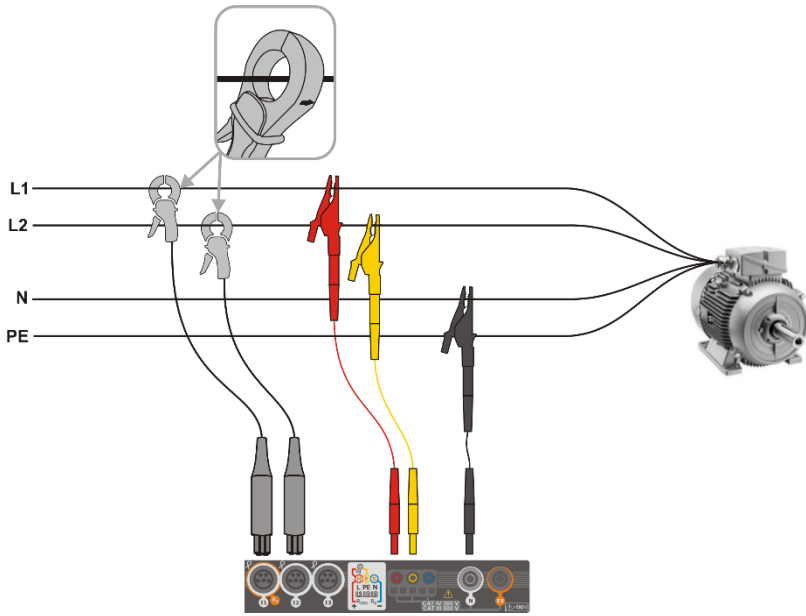

Fig. 5.5 Wiring diagram – 2-phase

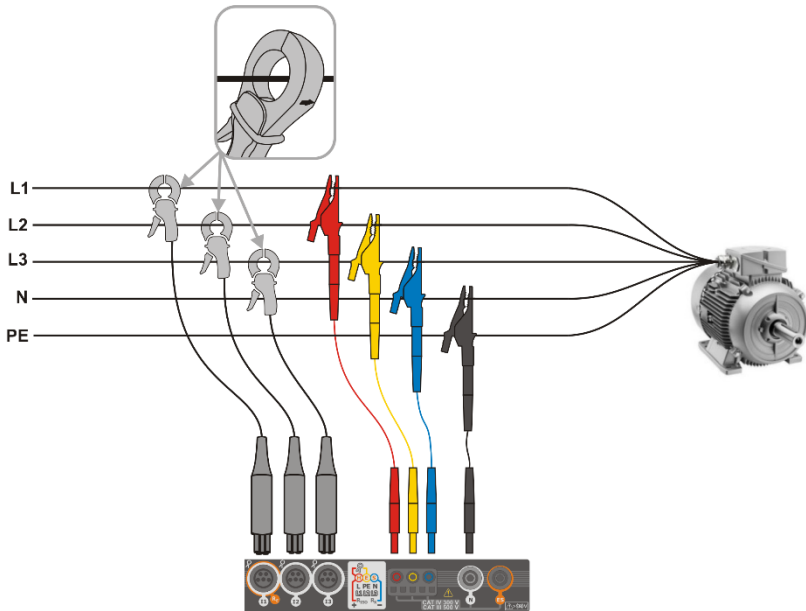

Fig. 5.6 Wiring diagram – 3-phase with four operating wires

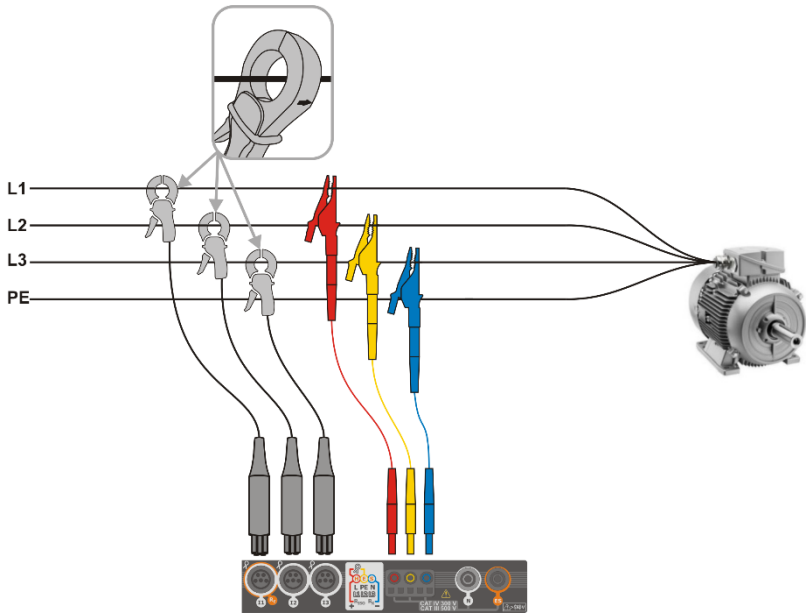

Fig. 5.7 Wiring diagram – 3-phase with three operating wires

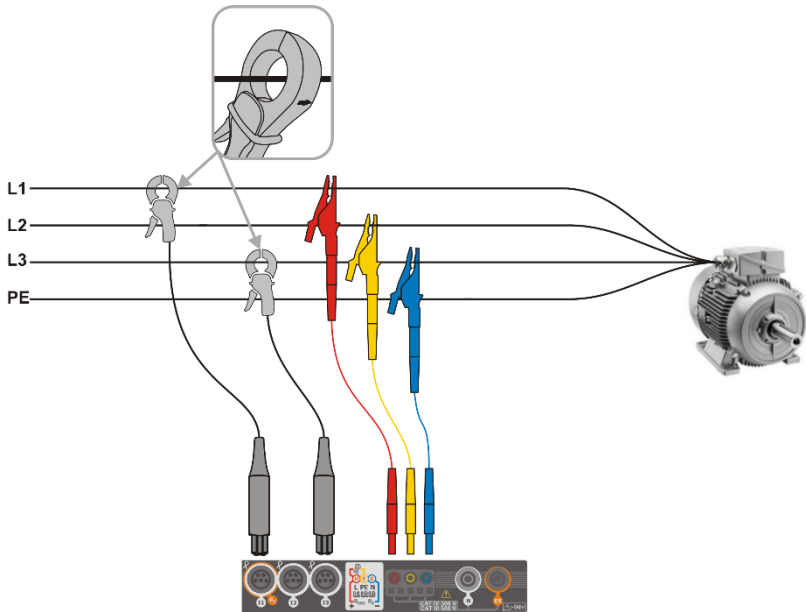



Fig. 5.8 Wiring diagram – 3-phase with three operating wires (measurement of currents using Aron method)

5.3.2 Verifying the connection

Selecting the top bar icon signalling the correct connection of the recorder (Fig. 5.3 element ) a window is displayed showing some important information on the connection of the recorder to the tested network. This information **helps the user to verify the compliance** of the current configuration of the recorder with the parameters of the measured network.

- **Voltage values** – two possible icons:
 - ✓ RMS voltages are correct, they are within the tolerance range \pm of 15% of the nominal voltage,
 - ✗ RMS values are outside the range of $U_{nom} \pm 15\%$.
- **Current values** – four options:
 - ✓ RMS currents are in the range of $0.3\% I_{nom} \dots 115\% I_{nom}$,
 - ? RMS currents are lower than $0.3\% I_{nom}$,
 - ✗ RMS currents are higher than $115\% I_{nom}$,
 - dashes are displayed when the current measurement is disabled in the configuration.
- **Voltage vectors** – the recorder verifies the correctness of the basic angles and displays the corresponding icon:
 - ✓ the vectors have correct angles in the range of $\pm 30^\circ$ of the theoretical value for a resistive load and symmetrical circuit (in 3-phase systems),
 - ? the accuracy of angles cannot be verified, because the RMS voltage value is too low (less than 1% of U_{nom}),
 - ✗ incorrect angles of vectors. In three-phase systems, this icon is displayed, among others, in case of reversed sequence of voltage phases.
- **Current vectors** – correctness of vector angles is verified for the components of main currents in relation to the voltage vectors. The following icons are displayed:
 - ✓ vectors are within $\pm 55^\circ$ in relation to angles corresponding to the voltage vectors,
 - ? the accuracy of current vector angles cannot be verified, because the RMS current values are too low (below 0.3% of I_{nom}),
 - ✗ vectors are outside the acceptable range of angles ($\pm 55^\circ$),
 - dashes are displayed when the current measurement is disabled in the configuration
- **Frequency:**
 - ✓ the measured grid frequency is in the range of $f_{nom} \pm 10\%$,
 - ? the RMS value of reference voltage phase is lower than 10V or there is no PLL synchronization,
 - ✗ the measured frequency is outside of $f_{nom} \pm 10\%$.

The icon is displayed in the top control bar in the following way:

- ✗ if the table includes is at least one ✗,
- ? if the table includes is at least one ?, but there is no error (no ✗),
- ✓ if all measured parameters are correct.

5.4 Recording configuration

Before any measurement it is necessary to properly configure the recorder in accordance with the requirements of the user. Configuration changes are made from the meter level.

5.4.1 Configuration using the meter

To access the configuration module on the main screen, select section **Recording configuration**. The list is displayed with measurement configurations saved in the recorder memory (Fig. 5.9).

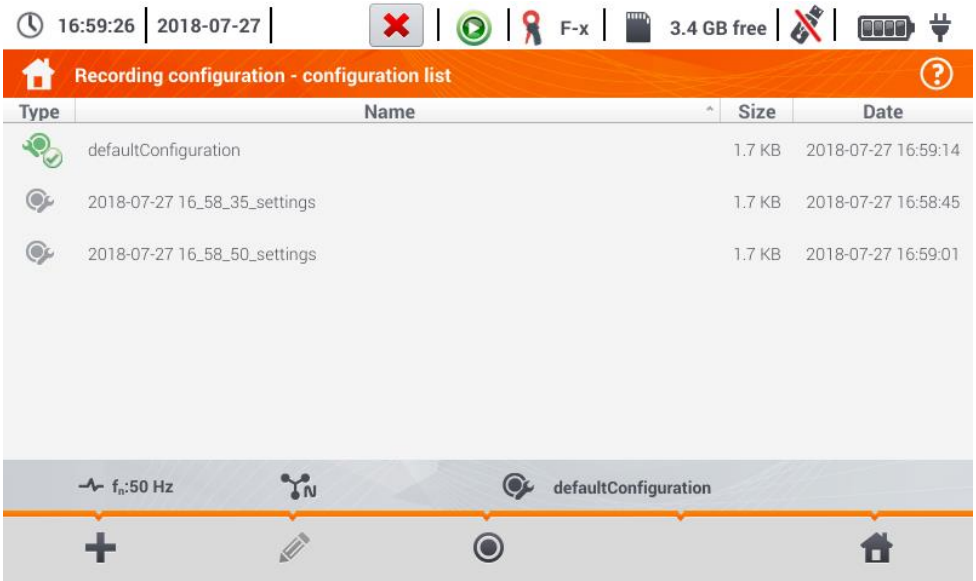

Fig. 5.9. Recording configuration – configuration list.

The table consists of columns:

- **Type** – displayed icon determines the type of measurement configuration:
 - recording according to user configuration (inactive – grey)
 - recording according to user configuration (active – green)
- **Name** – the name of the configuration given by the user,
- **Size** – the size of the configuration file,
- **Date** – Date - date and time of creating the configuration.

The list can be **scrolled** by moving a finger across the window.

Item sorting is performed by tapping the header. The first row of the table contains the active configuration. In the next rows the item will be sorted:





- in ascending order (symbol next to the header),
- in descending order (symbol next to the header).

To **activate the desired configuration**, select its line, and then on the bottom bar select icon  (activating the configuration).

To **modify the selected configuration**, on the bottom bar select icon  (editing) or double-tap the line of this configuration.

To **add a new configuration**, select icon  (add).

Description of function icons

-  adding a new configuration
-  editing the active configuration
-  activating the selected configuration
-  returning to the main menu of the recorder mode



5.4.2 Recording configuration

After the  icon has been selected, a new window will be displayed as shown in Fig. 5.10. The default name of the new configuration will be displayed in the title bar, created from the current date and time in the "YYYY-MM-DD hh_mm_ss_settings" format, which may be modified.



An asterisk after the name indicates that the configuration has been **modified** but **not saved**.

Fig. 5.10. Recording configuration – general settings

Buttons  and  at the bottom menu bar are used to switch between successive screens.

At this point, you may define:

- **Mains system.** By selecting the icon from drop-down list  or on the network name, you can select the following types:
 - ⇒ **1-phase,**
 - ⇒ **split-phase,**
 - ⇒ **3-phase 4-wire** – systems with neutral wire, e.g. star with N,
 - ⇒ **3-phase 3-wire** – systems without neutral wire – star without N and delta,
 - ⇒ **3-phase 3-wire Aron** – as standard 3-wire system, but with the current measurement using two clamps (I_1 i I_3). The third current (I_2) is determined by calculation from the relationship $I_2 = -I_1 - I_3$.
- **Frequency** – mains nominal frequency. The following options are available:
 - ⇒ **50 Hz,**
 - ⇒ **60 Hz.**
- **Averaging period** - specifies the time of averaging recorded parameters and also the time between successive recorded data on a memory card (except events). The following settings are available:
 - ⇒ 1 s,
 - ⇒ 3 s,
 - ⇒ 10 s,
 - ⇒ 30 s,
 - ⇒ 1 min,
 - ⇒ 10 min,
 - ⇒ 15 min,
 - ⇒ 30 min.
- **Nominal voltage.** The following settings are available: 58/100, 64/110, 110/190, 115/200, 120/208, 127/220, 133/230, 220/380, 230/400, 240/415, 254/440, 290/500, 400/690 V
- **Clamps type** - here you can enable or disable the measurement of currents and determine the type of clamps. If the current measurement is required, indicate clamps to be used from the following list:
 - ⇒ **No** – clamps not applied,
 - ⇒ **F-1(A), F-2(A), F-3(A)** – flexible clamps (Rogowski coil) with a nominal range of 3000 A AC,
 - ⇒ **C-4** – clamps CT (with core) with a range of 1000 A AC,
 - ⇒ **C-5** – clamps with a Hall sensor with a range of 1000 A AC/DC,
 - ⇒ **C-6** – clamps CT (with core) with a range of 10 A AC,
 - ⇒ **C-7** – clamps CT (with core) with a range of 100 A AC.
- **Voltage events: Log events** – ticking this box enables voltage event detection: swells, dips, interruptions. Three field with values allow the user to introduce own thresholds for these three types of events. Thresholds may be entered in volts or as a percentage values referenced to the nominal voltage of the network, e.g. setting the threshold of swell as +10% at nominal voltage of 230 V triggers the detection of swell after exceeding 253 V voltage ($RMS_{1/2}$). The event ends when the voltage drops to the threshold value reduced by hysteresis. If the hysteresis in the described case is 2%, then the end of the event will occur if when voltage ($RMS_{1/2}$) is lower than 248.4 V ($253\text{ V} - 4.6\text{ V}$).

- **Current events: Log events** – ticking this box enables current event detection. Entering "0" disables a given event. The entered values may be from range 0 ... I_n (where I_n is the current measurement range after taking into account current transformers).
 - **L max [A]** - maximum value threshold for current L1, L2, L3 (depending on the network). An event is detected when the value of $RMS_{1/2}$ current exceeds the specified threshold.
 - **L min [A]** – minimum value threshold for current L1, L2, L3. An event is detected when the value of $RMS_{1/2}$ current drops below the specified threshold.
 - **N max [A]** – similarly to L max, but it relates to N current channel (neutral current).
 - **N min [A]** – similarly to L min, but it relates to N current channel (neutral current).
- **Settings: Hysteresis** - percentage value in the range from 0.1 to 10, to be used for detecting events. Higher values allow to limit the number of detected events if the parameter value fluctuates around the threshold. The typical value of the hysteresis is 2%.

Description of function icons



returning to configuration list without saving changes



saving changes Additional window will appear, where it is possible to:

⇒ change the name of configuration,

⇒ set the saved configuration as active or inactive ,

⇒ accept the selection (**Ok**),

⇒ cancel the selection (**Cancel**)



return to the main menu of the recorder mode

5.5 Analyzer settings

On the **Analyzer settings** screen it is possible to:

- specify the manner of clamps fastening,
- change the phase identification,
- view files stored in the recorder mode.

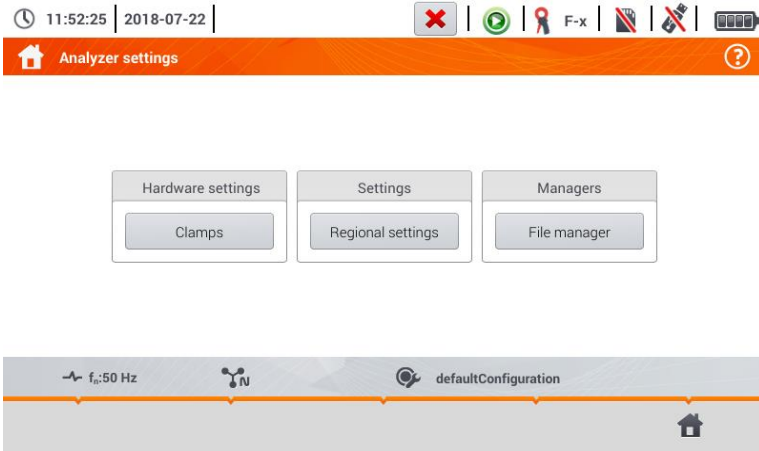

5.5.1 Hardware settings – clamps (manner of connecting)

If the clamps have not been attached in accordance with the direction of the current flow, this information can be entered into the meter. Then the recorder readings will be automatically corrected. This is useful in situations where the physical reversing of clamps is impossible or difficult.

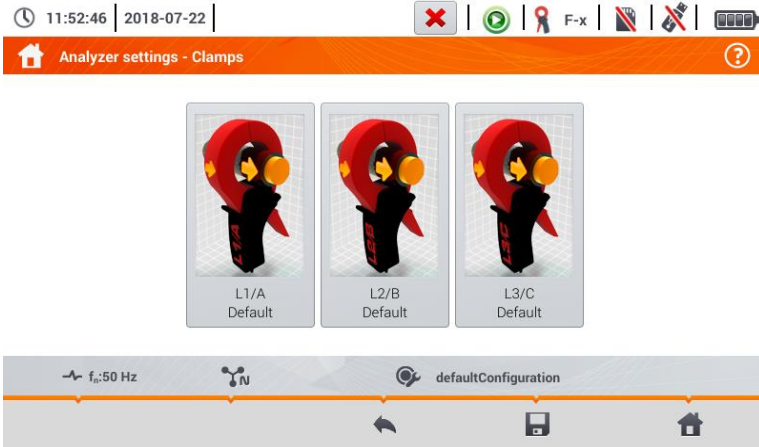

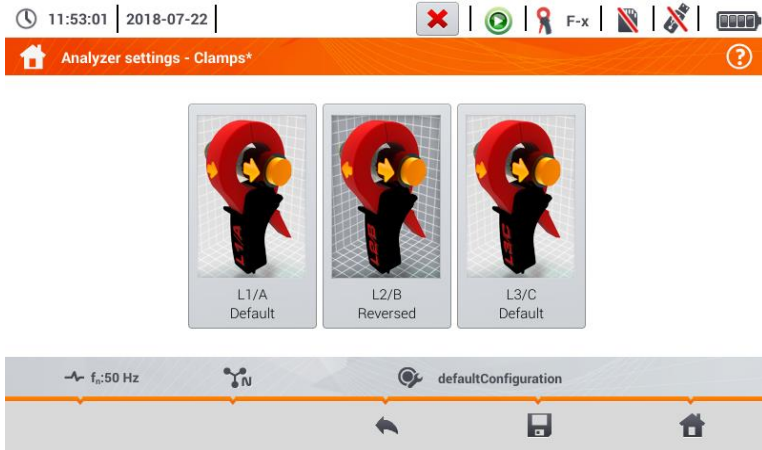

To **enter information** on the manner of attaching the clamps, tap the corresponding icon. The manner of connecting (forward/reverse) will change to the opposite (reverse/forward).



Phase of clamps can not be changed during the recording process.

Description of function icons

 returning to the recorder settings menu

 saving changes Additional window will appear, where it is possible to:
 ⇒ accept the selection (**Yes**)
 ⇒ cancel the selection (**No**)

 return to the main menu of the recorder mode

5.5.2 Settings – Regional settings

On the **Regional settings** screen it is possible to change:

- **identification of phases.** Available options:
 - ⇒ L1, L2, L3,
 - ⇒ A, B, C,
- **phase colours.** Wire colouring schemes are available for:
 - ⇒ the European Union,
 - ⇒ Australia,
 - ⇒ India,
 - ⇒ China,
 - ⇒ the United States,
 - ⇒ plus two additional schemes (U1, U2), configurable by the user.



Fig. 5.11 Regional settings

1



If option U_1 or U_2 has been selected, a screen of colour selection for a specific phase current or voltage waveforms will appear.

2

Tap the control of the required variable.

3

Tap the required colour in the colour selection area.

4



Repeat the 2 3 as many times as required.

5

Ok - confirming changes and returning to the previous screen

Cancel - rejecting the selection and returning to the previous screen

Description of function icons

-  returning to the **Analyzer setting** menu
-  saving changes
-  returning to the main menu of the recorder mode

5.5.3 Managers – file manager

On the **Analyzer settings – file manager** screen recordings saved to the memory of the meter can be viewed.

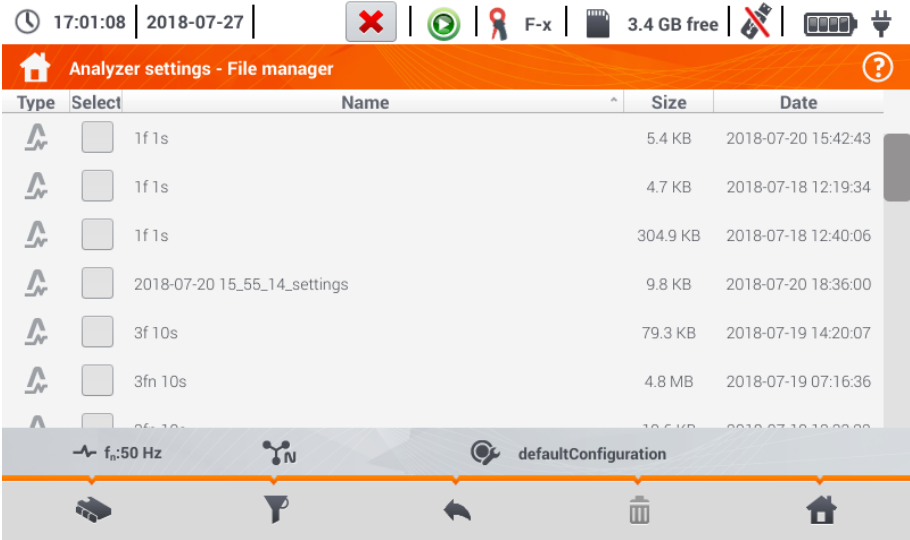

a. Data viewing

In the **Type** column icons are contained defining the type of record (waveform , screenshot , configuration file). Checkbox in the **Select** column lets the user activate the required entry (→).

Description of function icons

- selection of the location to be searched. After selecting, the menu with the following options appears:
 - microSD card selection
 - selection of the internal memory of the meter
 - saving active () files to a flash drive (option active if there is a flash drive in the USB slot)
 - activating/deselecting all records
 - closing the menu
- filtering the list of files. After the icon has been selected, filtering options appear (possibility of multiple selection, the active filter icon is **orange**):
 - saved waveforms
 - configuration file
 - screenshots with waveforms
- returning to the **Analyzer setting** menu
- removing active () record.
- returning to the main menu of the recorder mode

b. Data preview

From the file manager level the content of screenshots can be opened (symbol ). To do this, double-tap the required item (Fig. 5.12).

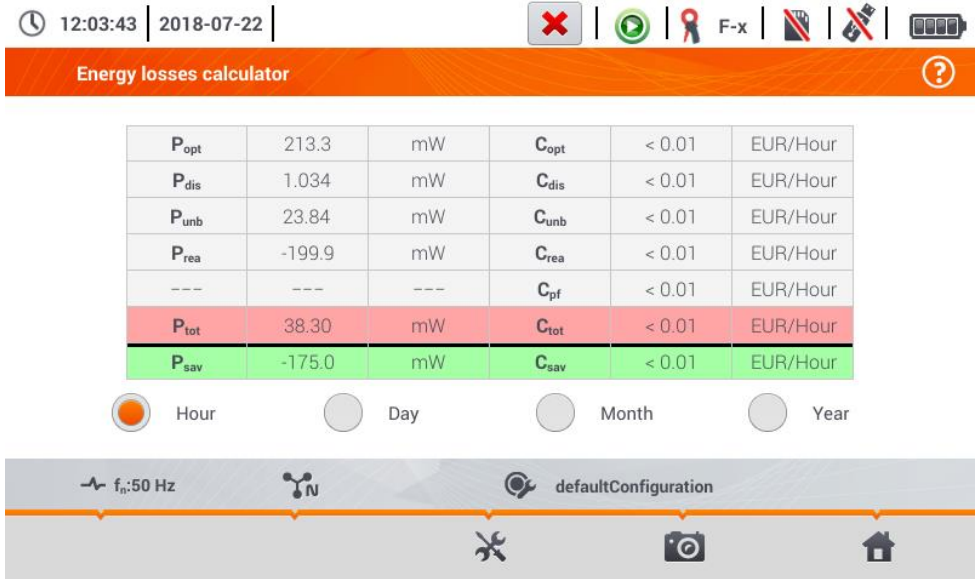











Fig. 5.12 Preview of a sample screenshot

Description of function icons

-  previous screenshot
-  next screenshot
-  return to the file manager
-  return to the main menu of the recorder mode

5.6 LIVE mode of the network

The recorder allows the user to preview network parameters in real time (LIVE mode). The icons of available views are displayed in the main recorder menu, in the bottom part:

-  view of waveforms of currents and voltages
-  timeplot view,
-  view of the table of measurements ,
-  view of the phasor diagram,
-  view of harmonics.

Screen refreshing in the LIVE mode can be temporarily blocked using the **HOLD** function (see description of the top bar in **section 5.2.1**).

- To pause refreshing, select the button on the top bar (the colour of the icon changes to **red**).
- To resume screen refreshing, select the icon again (the colour of the icon will change to **black**).

5.6.1 Transient waveforms of current and voltages (waveforms)

After the  icon has been selected the view of waveforms of currents and voltages is displayed. They show two periods of network waveforms for active channels (depending on the measurement configuration).

A sample screen is shown in Fig. 5.13 Use **labels** on the right side of the window to **switch on** and **off** individual measuring channels (at least one waveform must be always visible). Each label includes the **name of the channel** (for example "U L1") and its **effective value**.



Fig. 5.13. "Live" mode - waveforms

Description of function icons



menu of active channels. After touching, an additional menu bar is opened with buttons for enabling or disabling the display of a phase or current and voltage. The active channel is indicated by **orange** colour of the icon. Remember that the screen must **always display at least one waveform** (you can not turn off all of them). The menu displays only the buttons of channels that exist in the network layout. From this menu you can turn off:

- U collectively all voltage waveforms
- I collectively all current waveforms
- L1 collectively all phase L1 waveforms
- L2 collectively all phase L2 waveforms
- L3 collectively all phase L3 waveforms
- ⊗ selecting this icon closes the menu



zooming of the displayed waveform. After the icon has been selected, a menu expands with the following options:



after selecting this icon, use your finger to circle the area which is to be zoomed in. The graph is then enlarged; it may be moved with a finger up, down and to the sides



after selecting this icon graph will be zoomed out in steps



selecting this icon closes the zooming menu (also, the  may be selected)



icon for selecting the view type. An additional menu appears, where type of view of the LIVE mode can be changed



screenshot Selecting it saves the current contents of the main window to a graphic file. The file name is automatically created basing on the view name and the current date, for example *"Current Readings - waveforms – 2016-08-01 12_00_00"*. The files are saved to the internal memory of the meter



return to the main menu of the recorder mode



- The diagram can be scaled with gestures. To **zoom in, move apart** the two fingers touching the screen in the opposite directions). To **zoom out – bring together** the two fingers touching the screen).
- Waveforms return to their default size after turning on/off any channel (buttons on the right side).

5.6.2 Timeplot of effective values

After the  icon has been selected, the view of timeplot is displayed (Fig. 5.14). This view displays a graph of the effective values of voltages and currents in time. The whole window covers time of approx. 110 seconds. After filling the entire window, the chart moves to the left by 30 seconds.

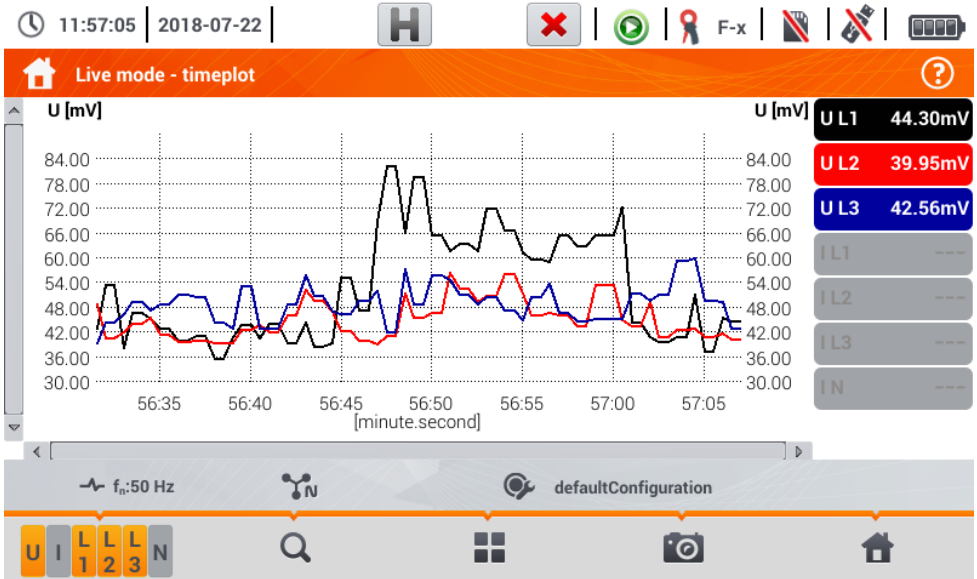









Fig. 5.14. "Live" mode - timeplot



Description of function icons

 Menu of active channels. After touching, an additional menu bar is opened with buttons for enabling or disabling the display of a phase or current and voltage. The active channel is indicated by **orange** colour of the icon. Remember that the screen must **always display at least one waveform** (you can not turn off all of them). The menu displays only the buttons of channels that exist in the network layout. From this menu you can turn off:

- U collectively all voltage waveforms
- I collectively all current waveforms
- L1 collectively all phase L1 waveform
- L2 collectively all phase L2 waveforms
- L3 collectively all phase L3 waveforms
-  selecting this icon closes the menu

 zooming of the displayed waveform. After the icon has been selected, a menu expands with the following options:

-  after selecting this icon, use your finger to circle the area which is to be zoomed in. The graph will be enlarged. After zooming in it may be moved with a finger up, down and to the sides
-  after selecting this icon graph will be zoomed out in steps.
-  selecting this icon closes the zooming menu (also, the  may be selected)

-  icon for selecting the view type. An additional menu appears, where type of view of the LIVE mode can be changed
-  screenshot Selecting it saves the current contents of the main window to a graphic file. The file name is automatically created basing on the view name and the current date, for example "Current Readings - waveforms – 2016-08-01 12_00_00". The files are saved to the internal memory of the meter
-  return to the main menu of the recorder mode



- The diagram can be scaled with gestures. To **zoom in**, spread the two fingers touching the screen in the opposite directions). To **zoom out** – bring together the two fingers touching the screen).
- Waveforms return to their default size after turning on/off any channel (buttons on the right side).

5.6.3 "Live" mode - tabular view

After the  icon has been selected a summary table with the values of network parameters is displayed. The table is refreshed in real time. A sample screen is shown in Fig. 5.15



Fig. 5.15. Live mode - measurements

The next lines were determined as follows:

- L1 phase values L1,
- L2 phase values L2,
- L3 phase values L3,
- N voltage values of the current channel I_N ,
- L1-2 phase-to-phase values L1-L2,
- L2-3 phase-to-phase values L2-L3,
- L3-1 phase-to-phase values L3-L1,
- Σ total values.

The next column show the values of individual parameters:

U [V]	RMS voltage,
U_{h01} [V]	RMS of the fundamental voltage component,
U_{DC} [V]	voltage constant component,
f [Hz]	network frequency,
I [A]	RMS current,
I_{h01} [A]	RMS of the fundamental current component,
I_{DC} [A]	current constant component,
P [W]	active power,
Q1 or QB [var]	reactive power of the fundamental component or reactive power, according to Budeanu (depending on the method of calculating reactive power),
S [VA]	apparent power,
S_N [VA] or D [var]	apparent distortion power or Budeanu distortion power (depending on the method of calculating the reactive power),
E_{P+} [Wh]	active energy consumed,
E_{P-} [Wh]	active energy returned,
E_{QL+} [varh]	inductive reactive energy consumed,
E_{QC-} [varh]	capacitive reactive energy supplied,
E_{QL-} [varh]	inductive reactive energy supplied,
E_{QC+} [varh]	capacitive reactive energy consumed,
E_s [VAh]	apparent energy,
PF	Power Factor,
cosφ	displacement power factor,
tanφL+	tangent φ inductive reactive energy consumed,
tanφC-	tangent φ capacitive reactive energy supplied,
tanφL-	tangent φ inductive reactive energy supplied,
tanφC+	tangent φ capacitive reactive energy consumed,
Pst	short-term flicker factor,
PIt	long-term flicker factor,
U₀ [V]	zero symmetric voltage component,
U₁ [V]	positive sequence symmetrical component of voltage,
U₂ [V]	negative sequence symmetrical component of voltage,
U₂/U₁ [%]	voltage unbalance factor for negative sequence,
U₀/U₁ [%]	unbalance factor for zero component of voltage,
I₀ [A]	current zero symmetrical component,
I₁ [A]	current positive sequence symmetrical component,
I₂ [A]	current negative sequence symmetrical component,
I₂/I₁ [%]	current unbalance factor for negative sequence,
I₀/I₁ [%]	current unbalance factor for zero sequence.

Description of function icons

 scrolling the table to the left/right (can also be moved using a finger)

 icon for selecting the view type. An additional menu appears, where type of view of the LIVE mode can be changed

 screenshot

 return to the main menu of the recorder mode

5.6.4 Vector diagram of fundamental components (phasor)

After the  icon has been selected the phasor diagram appears (example in Fig. 5.16). It shows the basic layout of component vectors of voltages and currents. It may be used to quickly verify the correctness of connecting the recorder to the network.

The following tables are next to the diagram:

the first, containing information on basic component values and their angles,

the second, containing the unbalance coefficients of negative components (the coefficients are only displayed for 3-phase networks).

The nature of the load is signalled by the icon of:

 the coil (inductive load) if the angle between the fundamental components of the voltage and current ($\varphi_{U_{h1}, I_{h1}}$) is greater than zero (voltage is ahead of current),



 the capacitor (capacitive load) if the angle $\varphi_{U_{h1}, I_{h1}}$ is negative (current is ahead of voltage).



Fig. 5.16. "Live" mode - phasor graph

Description of function icons

 icon for selecting the view type. An additional menu appears, where type of view of the LIVE mode can be changed

 screenshot

 return to the main menu of the recorder mode

5.6.5 Harmonics graph/table

After the  icon has been selected the mode of harmonics display is displayed. This screen allows you to view the harmonics of voltages and currents, angles between the current and voltage harmonics, $\cos\phi$ factors of these currents and THD factors. Harmonics are displayed graphically in a bar graph (default) or in a table.

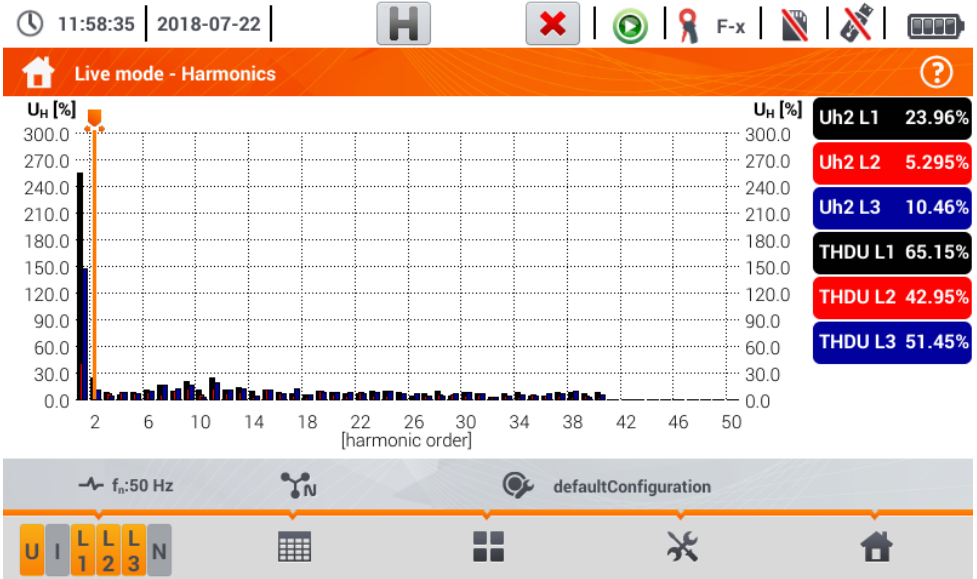





Fig. 5.17 Live mode - harmonics - bar graph

The graph includes:
graphs for the harmonics selected from the menu **Graph data selection**,
slider  - indicator of actual values. The user can slide it to any graph point.

Labels of individual waveforms are located on the right side of the screen. They display the participation of harmonics in the basic signal for these harmonics, which are indicated by the slider . In addition, tapping the label hides its corresponding graph (in graph mode only).

Description of function icons

 menu of active channels. After clicking, an additional menu bar is opened with icons for enabling or disabling the data and to switch between current and voltage harmonics. The active channel is indicated by **orange** colour of the icon

 switching to tabular view of harmonics (Fig. 5.18). The table in each row displays the harmonic values (from DC harmonic to the harmonic of 40th order) or the angles between the current and voltage harmonics. In case of harmonics, the values may be displayed in absolute units (V/A), or as percentage related to the fundamental harmonic

 switching to histogram view









-  icon for selecting the view type. An additional menu appears, where type of view of the LIVE mode can be changed
-  options menu for a chart or table. After selecting it, an additional menu bar is displayed, which provides several new options:
 -  hide/show the fundamental harmonic (not available in tabular view)
 - [V,A]** displaying values in absolute units (volts and amps)
 - [%]** displaying values as percent in relation to the fundamental component.
 -  screenshot
 -  closing the menu
-  return to the main menu of the recorder mode



Fig. 5.18. Live mode - harmonics - tabular view

5.7 Switching the recording on/off

After correct configuration you can **trigger recording** by pressing the **START** button. Recording in-progress is signalled by icon  on the top bar and flashing red LED.

To **stop recording**, press the **START** button and confirm your intention to stop in the pop-up window. Stopping the recording will be **confirmed by sounds** (three long and three short signals) and the colour of the recording icon will change into , and the red LED will stop flashing.



Recording ends automatically when the memory card is **full**, recording terminates **automatically**.

5.7.1 Approximate recording times

The maximum recording time depends on several factors, such as:

- memory card capacity,
- averaging time,
- network type,



A few selected configurations are given in Tab. 5.2. The last column specifies the approximate recording times when the memory card is almost completely empty and has approx. 3.6 GB of free space. If the averaging time is different than the one chosen for the sample user configuration of 1 second, the approximate time of recording is proportionally extended, e.g. for 10-second averaging, the recording time will be 10 times the specified recording time at 1-second averaging.

Tab. 5.2. Approximate recording times for a few typical configurations.

Averaging period	System type (current measurement on)	Current Measurement	Approximate recording time with 3.6 GB allocated space
10 minutes	3-phase 4-wire	•	> 10 years
10 minutes	1-phase	•	> 10 years
1 second	3-phase 4-wire	•	90 days
1 second	3-phase 4-wire		144 days
1 second	1-phase	•	250 days
1 second	1-phase		330 days
1 second	3-phase 3-wire	•	125 days
1 second	3-phase 3-wire		144 days

5.7.2 Recording guidelines

Before starting the recording, pay attention to the following issues:

- Verify time of the instrument. If the date or time are incorrect, correct data must be entered in accordance with **section 2.1.1**.
- Verify connections of the analyzer with the tested network. If the icon for the correct connection of the analyzer on the top bar is  or , then before recording parameters, an additional window is displayed warning about a potential problem with the connection. The user must:
confirm the start of recording despite this or
resign from the start.
- For more information about the potential problem:
call up the connection correctness window (section 5.3.2).
It may also be helpful to check the phasor diagram (section 5.6.4) - vectors of voltages and currents; rotation sequence of phases in 3-phase system should be such that phase UL1 (UL1-2) is at 0°, UL2 (UL2-3) approx. -120°, UL3 (UL3-1) approx. -240°. Both unbalance factor (for voltage and current) shown on this screen should be low (typically less than 10%).
The display of waveforms may be checked for the shape of the waveforms and the effective values of voltages and currents.
The correct connection of current clamps may be verified by checking the mark(s) of active power - in most cases of operation of receivers this sign will be positive.
- If the recording is longer, ensure the continuity of power supply by connecting an external 12 V power supply adapter to the socket of the meter (the bar in the upper right corner will show an electric plug icon).
- The memory card must be inserted into the socket, and have enough free space (which is indicated on the top bar). If the card has not enough free space for the expected records (which depends e.g. on the averaging time, recording time, network type), you must ensure a free space by deleting previous records (go to **Analyzer settings → File manager**).
- Recording takes the name of measurement configuration, which is active at the time of its triggering and there is no possibility to change it later. Therefore, it may be helpful to name the configuration before that, using a name which describes the measurements to facilitate finding it on the list of records (the name of the configuration can be modified before the start, entering the edition of active configuration).

5.8 Recording analysis

Analysis of the recorded data is possible directly using the meter itself, without additional software. The scope of the analysis includes:

- general preview of the recording - start and end time, average values of voltages and currents,
- preview the average value of voltage across the whole recording range,
- preparing timelines of any recorded parameters (limited to 1100 points and 4 parameters on a single graph) with zoom-in option and time-point marker.
- preview of bar graph for harmonics (average value for the whole recording period).





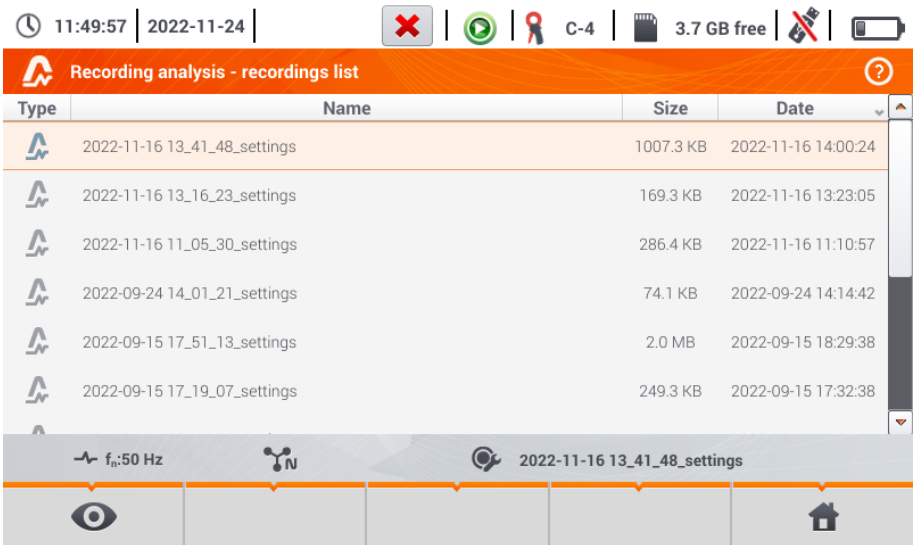

It is possible to analyse records completed and saved on the memory card and on-going records.

The list of recording (entries on the symbol ) stored in the meter memory can be found on the **Recording analysis – recording list** screen. The list can be scrolled by moving your finger up and down within the visible summary.







① To open the contents of the file:





- double-tap the desired item or
- activate the required item and select the  icon with one tap.



11:49:57 | 2022-11-24 |    C-4 |  3.7 GB free |  

Recording analysis - recordings list 

Type	Name	Size	Date
	2022-11-16 13_41_48_settings	1007.3 KB	2022-11-16 14:00:24
	2022-11-16 13_16_23_settings	169.3 KB	2022-11-16 13:23:05
	2022-11-16 11_05_30_settings	286.4 KB	2022-11-16 11:10:57
	2022-09-24 14_01_21_settings	74.1 KB	2022-09-24 14:14:42
	2022-09-15 17_51_13_settings	2.0 MB	2022-09-15 18:29:38
	2022-09-15 17_19_07_settings	249.3 KB	2022-09-15 17:32:38

   2022-11-16 13_41_48_settings 

2

11:50:23 | 2022-11-24 |



C-4



3.7 GB free



Recording analysis - recording summary



Recording configuration: 2022-11-16 13_41_48_settings

Start:	2022-11-16 13:43:08		$U_{AVG\ MIN}$	U_{AVG}	$U_{AVG\ MAX}$
Stop:	2022-11-16 14:00:24	L1:	2.714V (1.18%Un)	232.1V (100.91%Un)	248.0V (107.82%Un)
Duration:	0d 0h 17m 16s	L2:	1.034V (0.45%Un)	231.9V (100.82%Un)	242.7V (105.54%Un)
		L3:	2.931V (1.27%Un)	231.7V (100.72%Un)	243.0V (105.64%Un)
Swells: 140	Interruptions: 6	N:	-- (-%Un)	-- (-%Un)	-- (-%Un)
Dips: 44	Other: 4				
All: 194					
		L1:	$I_{AVG\ MIN}$	I_{AVG}	$I_{AVG\ MAX}$
		L2:	131.5mA	306.4mA	627.1mA
		L3:	257.9mA	291.5mA	338.3mA
		N:	244.3mA	398.4mA	722.6mA
			---	---	---



The record content will appear (recording summary). The following parameters will be shown on the screen:

Start – time of starting the recording process,

Stop – time of stopping the recording process,

Duration (of the recording process).

In addition, the parameters of voltage and current in the phase conductor and the neutral conductor are shown:

$U_{AVG\ MIN}$ minimum average voltage; the percentage relative to rated voltage Un is shown in brackets,

U_{AVG} average voltage; the percentage relative to rated voltage Un is shown in brackets,

$U_{AVG\ MAX}$ maximum average voltage; the percentage relative to rated voltage Un is shown in brackets,

$I_{AVG\ MIN}$ minimum average current,

I_{AVG} average current,

$I_{AVG\ MAX}$ maximum average current.

Recording analysis - recording summary

Recording configuration: 2022-11-16 13_41_48_settings

Start:	2022-11-16 13:43:08		$U_{AVG\ MIN}$	U_{AVG}	$U_{AVG\ MAX}$
Stop:	2022-11-16 14:00:24	L1:	2.714V (1.18%Un)	232.1V (100.91%Un)	248.0V (107.82%Un)
Duration:	0d 0h 17m 16s	L2:	1.034V (0.45%Un)	231.9V (100.82%Un)	242.7V (105.54%Un)
		L3:	2.931V (1.27%Un)	231.7V (100.72%Un)	243.0V (105.64%Un)
Swells: 140	Interruptions: 6	N:	-- (-%Un)	-- (-%Un)	-- (-%Un)
Dips: 44	Other: 4				
All: 194					
			$I_{AVG\ MIN}$	I_{AVG}	$I_{AVG\ MAX}$
		L1:	--	--	--
		L2:	--	--	--
		L3:	--	--	--
		N:	--	--	--

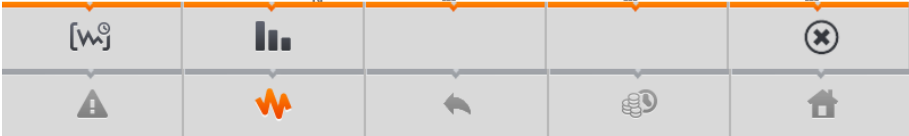

Description of function icons

- event list (**section 5.8.3**)
- expanding graphical analysis options:
 - recording timeplot (**section 5.8.1**)
 - harmonics waveform graph (**section 5.8.2**)
- closing the menu
- return to the file manager
- energy costs calculator (**section 5.8.4**)
- return to the main menu of the recorder mode



- **Minimum and maximum voltage values** are determined from the recorded **average values** (these are not minimum and maximum RMS_{1/2} values). In addition to the values in volts, in brackets you can see the percentage value related to the nominal voltage. If a channel has not been measured in a given configuration, dashes are displayed.
- **Minimums and maximums of currents** are determined **from the average currents**. If a channel has not been measured in a given configuration, dashes are displayed.

5.8.1 Recording timeplot

a. Functional Description

If in **section 5.8** step ③ the  icon has been selected, the screen shown in **Fig. 5.19** will appear.

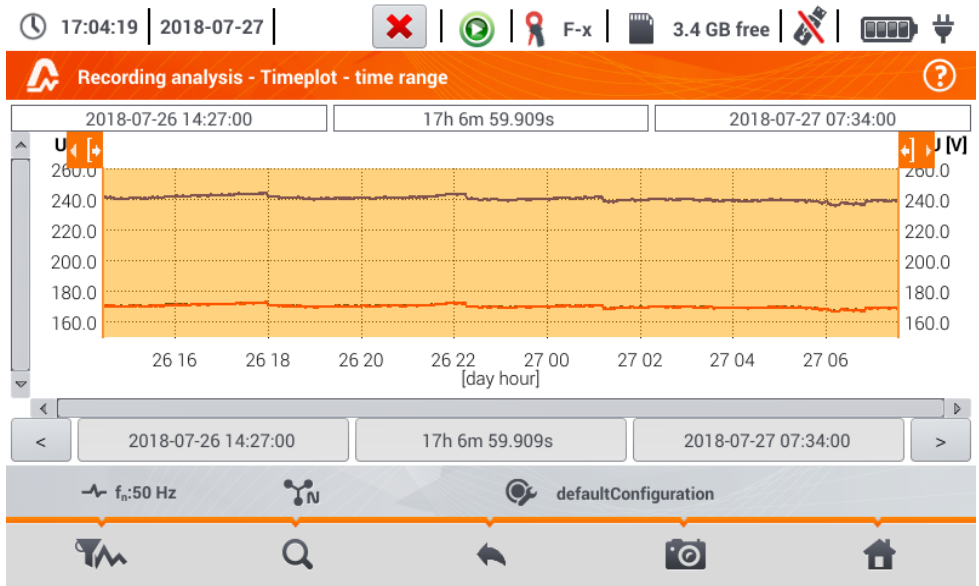

Fig. 5.19. Recording timeplot

The range of data to be analysed may be determined in two ways:



- by dragging the   icons above the graph or
- by manually entering boundary values of date and time and the interval for analysis.

Fig. 5.20 Setting the beginning of the analysis range

Fig. 5.21 Setting the width of the analysis range

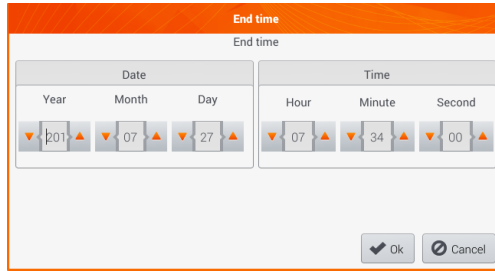











Fig. 5.22 Setting the end of the analysis range

The   icons reset the analysis range to initial settings.

Description of function icons

-  opens the **Selecting data for the plot** menu. The parameters to be analysed can be selected on this screen. A detailed description is provided in point **b**.
-  zooming of the displayed waveform. After tapping, an additional menu expands with icons:
 -  after selecting this icon, use you finger to circle the area which is to be zoomed in. The graph will be enlarged. After zooming in it may be moved with a finger up, down and to the sides
 -  after selecting this icon graph will be zoomed out in steps
 -  selecting this icon closes the zooming menu
 -  returning to **Recording analysis – recording summary** menu
-  performing the screenshot
-  return to the main menu of the recorder mode



The diagram can be scaled with gestures. To **zoom in, move apart** the two fingers touching the screen in the opposite directions). To **zoom out – bring together** the two fingers touching the screen).

b. Selecting parameters for the timeplot

After selecting the  icon, the **Selecting data for the plot** screen opens. The parameters to be analysed can be selected here. Types of readings are assigned to each of the categories, and the parameters which may be selected are assigned to these.

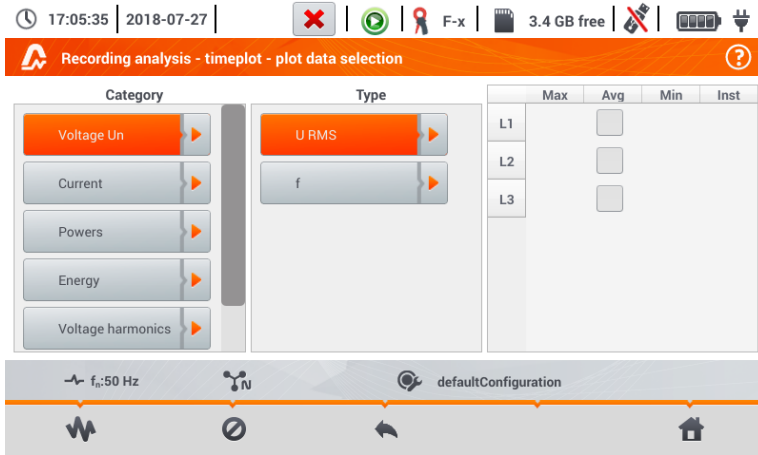

Available option (differing depending on the network layout)

- **Un voltage**
 - U RMS (effective voltage) – for phases L1, L2, L3 (A, B, C)
 - U L-L (phase-to-phase voltage)
 - f (frequency) – for phase L1 (A)
- **Current**
 - I RMS (effective current) – for phases L1, L2, L3 (A, B, C)
- **Power**
 - P (active power) – for phases L1, L2, L3 (A, B, C) and Σ sum
 - Q1 (reactive power) – for phases L1, L2, L3 (A, B, C) and Σ sum
 - S_n (distortion power) – for phases L1, L2, L3 (A, B, C) and Σ sum
 - S (apparent power) – for phases L1, L2, L3 (A, B, C) and Σ sum
 - cos ϕ – for phases L1, L2, L3 (A, B, C) and Σ sum
 - PF (power factor) – for phases L1, L2, L3 (A, B, C) and Σ sum
- **Energies**
 - EP+ (active energy consumed from network) – for phases L1, L2, L3 (A, B, C) and Σ sum
 - EP- (active energy supplied to network) – for phases L1, L2, L3 (A, B, C) and Σ sum
 - EQ+ (reactive energy consumed from network) – for phases L1, L2, L3 (A, B, C) and Σ sum
 - EQ- (reactive energy supplied to network) – for phases L1, L2, L3 (A, B, C) and Σ sum
 - ES (apparent energy) – energy for phases L1, L2, L3 (A, B, C) and in total Σ
- **Harmonics U**
 - THD U (total harmonic distortion) – for phases L1, L2, L3 (A, B, C)
 - U h1...U h40 (1...40. voltage harmonic) – for phases L1, L2, L3 (A, B, C)



- In the window for selecting the parameters, only those parameters are displayed which were recorded.
- For better orientation, the fields with parameters selected for the chart, the fields of category and type are surrounded by orange border, if they contain any selected parameters.
- If you have already ticked four parameters, any attempt to select another will result in displaying a message on limited number of parameters in the chart.

Description of function icons



calling up the time graph



deselecting all variables



returning to menu **Timeplot – time interval** (pointa)



return to the main menu of the recorder mode

c. Creating and managing a timeplot

1 17:05:54 | 2018-07-27 | [X] [Play] [Lock] F-x | 3.4 GB free | [Signal] [Battery] [Charging]

Recording analysis - timeplot - plot data selection [?]

Category	Type	Max	Avg	Min	Inst
Voltage Un	U RMS		<input checked="" type="checkbox"/>		
Current	f		<input checked="" type="checkbox"/>		
Powers					
Energy					
Voltage harmonics					

f_n: 50 Hz N defaultConfiguration

[Waveform] [No selection] [Back arrow] [Home]

Select the data to be displayed on the plot on the **Selecting data for the plot** screen. For this purpose:

- in the **Category** column select the required item, in the **Type** column select the required parameter, and in the last column select the required variable (→)
- select the icon.

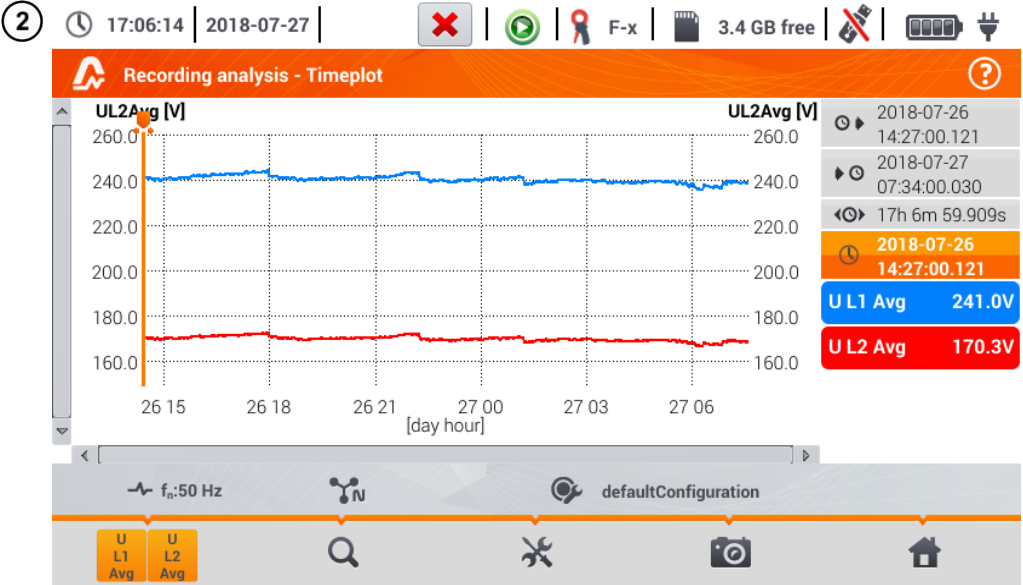

The timeplot appears. It includes:
 waveforms for the values selected in the menu **Selecting data for the plot**,
 slider - indicator of actual values. The user can slide it to any graph point.

On the right side of the screen you can see:

- time of starting the recording process,
- time of stopping the recording process,
- duration of the recording process.
- time corresponding to the position of the slider .

labels for individual waveforms. They display instantaneous values of the readings, corresponding to the position of the slider on the plot. In addition, tapping the label hides the graph that it represents.

Description of function icons

menu of active channels. After this icon has been selected, an additional menu bar opens with buttons to enable and disable the display of waveforms set for step ①. The active channel is indicated by **orange** colour of the button.

zooming of the displayed waveform. After the icon has been selected, a menu expands with the following options:

- after selecting this icon, use your finger to circle the area which is to be zoomed in. The graph is then enlarged; it may be moved with a finger up, down and to the sides
- after selecting this icon graph will be zoomed out in steps
- selecting this icon closes the zooming menu (also, the may be selected)



options menu for a chart or table. After the selection has been made, an additional menu bar appears which enables selection of a scale description on the right side and on the left side of the graph. To do this, click on the icon with the name of the parameter.



The icon with the unit name is displayed when the graph has at least two parameters with the same unit. **Select** this icon to **rescale waveforms** having the same unit to a **common scale** (described by one of the common parameters). Remember that when scales are not unified, only one waveform with unit assigned to the axis is scaled to the indicated scale and its plot is adjusted to the size of the window - other waveforms, even having the same unit, are not scaled.



returning to the **Selecting data for the plot** menu



performing the screenshot



The diagram can be scaled with gestures. To **zoom in, move apart** the two fingers touching the screen in the opposite directions). To **zoom out – bring together** the two fingers touching the screen).

5.8.2 Harmonics waveform graph

If in **section 5.8** step ③ the  icon has been selected, the screen shown in Fig. 5.23 will appear. The workspace consists of a graph, the labels menu and function icons menu. This screen allows you to view the harmonics of voltages and currents, angles between the current and voltage harmonics, $\cos\phi$ factors of these currents and THD factors. Harmonics are displayed graphically in a bar graph (default) or in a table.

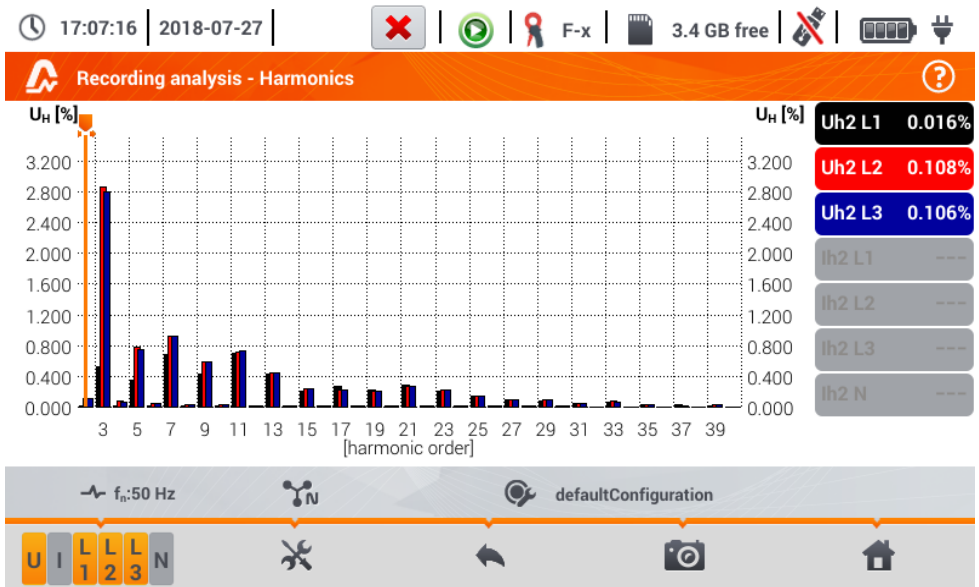

Fig. 5.23. Live mode - harmonics - bar graph

The graph includes:
 graphs for the harmonics selected from the menu **Graph data selection**,
 slider - indicator of actual values. The user can slide it to any graph point.

Labels of individual waveforms are located on the right side of the screen. They display the **name of the harmonic** and its **participation** in the basic signal for these harmonics, which are indicated by the slider . In addition, tapping the label hides its corresponding graph.

Description of function icons

menu of active channels. After selecting the icon, an additional bar is opened with buttons for enabling or disabling the data and to switch between current and voltage harmonics. The active channel is indicated by **orange** colour of the icon.

options menu for a chart or table. After selecting it, an additional menu bar is displayed, which provides several new options:

- hide/show the fundamental harmonic
- [V,A]** displaying values in absolute units (volts and amps)
- [%]** displaying values as percent in relation to the fundamental component.
- switching to tabular view of harmonics (Fig. 5.24). Each row in the table displays the values of harmonics (harmonics up to the 40th and additionally for the **[%]** mode – also THD)

closing the menu

returning to the previous screen

performing the screenshot

returning to the main menu of the recorder mode

17:07:43 | 2018-07-27 | | F-x | 3.4 GB free |

Recording analysis - Harmonics

	U _{L1} [%]	U _{L2} [%]	U _{L3} [%]
THD	1.432	3.331	3.266
h01	100.0	100.0	100.0
h02	0.016	0.108	0.106
h03	0.520	2.869	2.800
h04	0.014	0.073	0.070
h05	0.357	0.778	0.741
h06	0.011	0.051	0.049
h07	0.684	0.923	0.923
h08	0.011	0.031	0.029

Fig. 5.24. Live mode - harmonics - tabular view

5.8.3 Event list

Selecting option  from the recording summary screen (in the bottom menu) will display a window with a list of recorded events. The analyzer may detect the following types of events:

In 50/60Hz systems:

- voltage dips,
- voltage swells,
- voltage interruptions,
- exceeding the maximum current threshold ($I > \text{max.}$), separate thresholds for $I_{1,2,3}$ and I_N
- dropping below the minimum current threshold ($I < \text{min.}$), separate thresholds for $I_{1,2,3}$ and I_N

In DC systems:

- exceeding the absolute maximum DC voltage threshold ($|U_{DC}| > \text{max.}$)
- exceeding the absolute maximum DC current threshold ($|I_{DC}| > \text{max.}$)

If the user selected detection of any of the events listed above in the measurement configuration screen, and if these events have been recorded, the list will include all of them. An example of the event window is shown in Fig. 5.25.

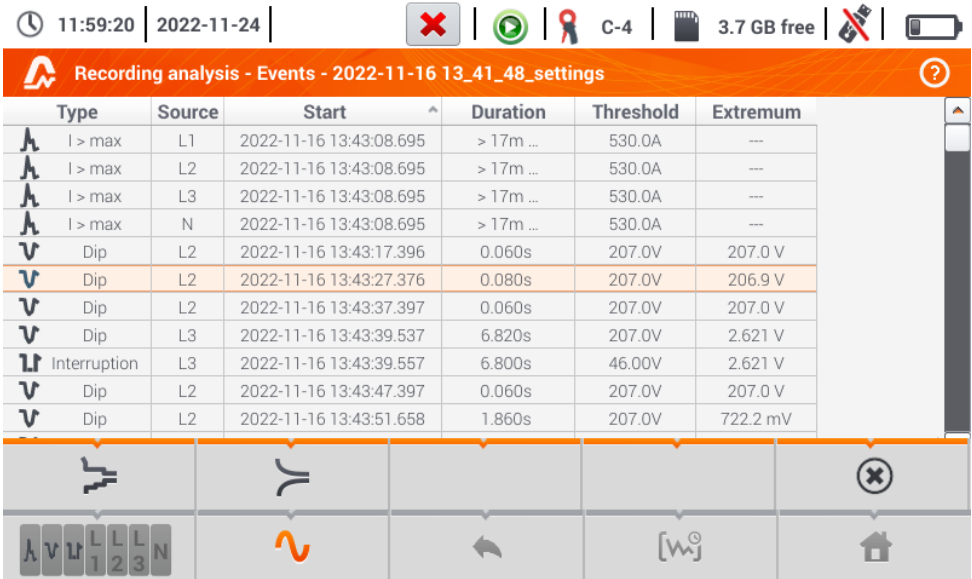

Fig. 5.25. Recording analysis – list of events

The table contains the following columns:

- **Type** of event: dip, interruption, swell, I > max, I < min, $U_{DC} > \text{max.}$, $I_{DC} > \text{max.}$
- **Source** of event: channel where the event occurred,
- **Start**: date and time of beginning of event,
- **Duration** of the event (if the event was in progress when recording was ended, an additional sign ">" is displayed, which means that the event has not been ended),
- **Threshold**: threshold value that has been set in the recording configuration,
- **Extremum**: parameter limit value (maximum or minimum, depending on the event type), which was recorded during the event. For example, in case of voltage dip, it is a residual voltage, which is the lowest $U_{RMS1/2}$ value recorded during the dip.

The table may be sorted by selected column after clicking its header. Next to the column name, a small arrow is present to show the direction of sorting.

Menu bar functions

After selecting a specific event in the table (by clicking its line), you can perform additional operations by selecting the following options from the menu bar:

 - opens additional menu of waveforms:

 - ANSI chart. It shows the graph of voltage events according to ANSI criteria. Dots represent individual events and their location indicates the duration (horizontal axis) and peak (*extremum* in the event table) related to the nominal voltage on the vertical axis. Arrow icons on the right side of the graph may be used to select individual events. By touching the screen in the graph area, the user may move the marker to the indicated place. Information about the specified event (type, duration, extreme value) are shown on the right side of the screen. An example of screen with similar diagram is shown in Fig. 5.26.



Fig. 5.26. Recording analysis – ANSI graph

☞ - CBEMA graph. It shows the graph of voltage events according to CBEMA criteria. Description of the graph and its properties are similar to ANSI chart (see above). An example of screen with similar diagram is shown in Fig. 5.27.







Fig. 5.27. Recording analysis – CBEMA graph

5.8.4 Energy costs calculator

a. Functional Description

When the parameters recorded by the recorder include active energy E_P , it is possible to calculate the energy costs according to the cost calculator set by the user. To enter the screen of the energy cost

calculator, use the bar on the recording summary window (section 5.7 step ③) and select icon . The screen with energy costs will be displayed as shown in Fig. 5.28. The following sections present:

- **Recording time** –  start,  end and  duration of the recording. The last line shows the  duration which is analysed by the algorithm of the cost calculator (full aggregation periods). The algorithm enables the calculation of the energy costs for the whole recording period and there is no option to select a different time interval.
- **Energy** – this field displays the total active energy in kilowatt-hours measured in the reporting time interval.
- **Single zone tariff** – this section displays the total cost of energy in the selected currency for single-zone variant. The tariff of this type has a single flat rate per kWh, regardless of the time of day and day of the week. **Tariff type** (may be modified by the user) is displayed **in the upper part**.
- **Multi-zone tariff** – shows the total cost of energy in the chosen currency in the multi-zone variant. This tariff allows you to define two continuous time intervals in 24 hours, which have different cost rates per kWh, and the third the rate for other times of the day. **Tariff type** (may be modified by the user) is displayed **in the upper part**. Configuration of rates and zones is carried out in the control panel of the energy cost calculator.





If you have not used or have not changed the settings of the cost calculator, the recorder will use the default settings. The settings of the cost calculator may be modified by selecting from the menu bar the  icon.



Fig. 5.28. Screen with indications of the energy cost calculator

Description of function icons

-  entering the settings of the energy cost calculator.
-  returning to the previous screen
-  performing the screenshot
-  returning to the main menu of the recorder mode

b. Settings of the energy cost calculator.

The settings of the cost calculator may be easily modified to fit individual needs. The calculator allows you to calculate costs for two tariffs:

- **Single zone tariff** – this is the simplest form of tariffs - a single rate for each kilowatt is taken into account throughout the analysed interval, regardless of time of day or day of the week,
- **Multi-zone tariff** – more extensive tariff. It allows you to set three different rates that apply in different time intervals:
 - ⇒ **Zone A billing rate** – you may enter the cost of 1 kWh for the first time interval of the day (e.g. daytime rate),
 - ⇒ **Zone B billing rate** – you may enter the cost of 1 kWh for the second time interval of the day (e.g. night-time rate),
 - ⇒ **Zone C billing rate** (not included in zones A and B).

Settings of the cost calculator are divided into two screens (**Fig. 5.29** and **Fig. 5.30**). The first screen allows you to configure the following parameters:

- **Currency** – you can choose from a list of several predefined currencies (PLN, EUR, USD, RUB, INR) or set your own (up to four characters), which will be shown on the list as the last position and marked with an asterisk (*).
- For **single zone tariff**:
 - ⇒ **Name of the single zone tariff** (C11 as default) – after clicking the name field a panel is displayed for editing.
 - ⇒ **Single zone rate** – the cost of 1 kWh of energy for the single zone tariff. The panel for editing will be displayed after the value field has been selected. The value may also be changed using the  icons. Rate values may be entered with an accuracy of four decimal places.

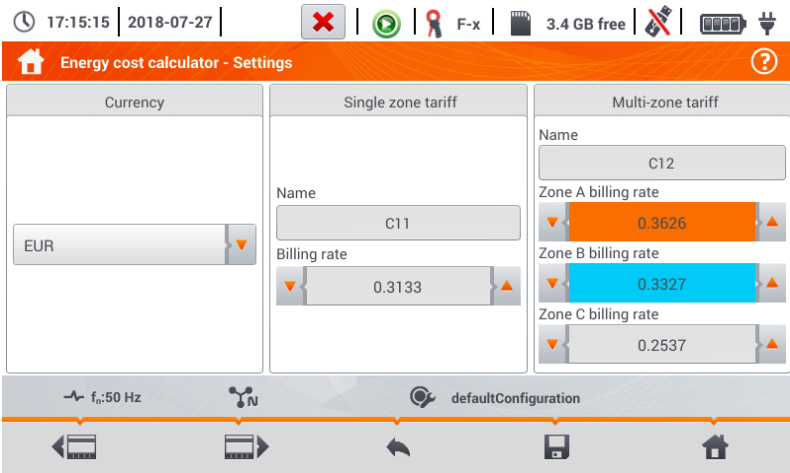

Fig. 5.29 Energy cost calculator – Settings

- For **Multi-zone tariff**:

- Name of the zone** (C12 as default),
- Zone A billing rate for 1 kWh** (colour: **orange**),
- Zone B billing rate for 1 kWh** (colour: **blue**),
- Zone C billing rate for 1 kWh** (for other times of the day).

Time intervals of the day corresponding to A, B and C zones are set on the second screen with cost calculator settings (Fig. 5.30). The main elements are the bars representing the entire day, divided into 15-minute blocks.

In the **simpler variant**, the same zone settings are valid for all days of the week (only the set marked with icon **1**). If you need to configure **other time intervals** for the selected days (e.g. for Saturdays and Sundays), then selecting the box at the bottom left of the window unlocks the second set of time intervals marked with icon **2**. Select weekdays for the second set by indicating the selection boxes for desired week days.

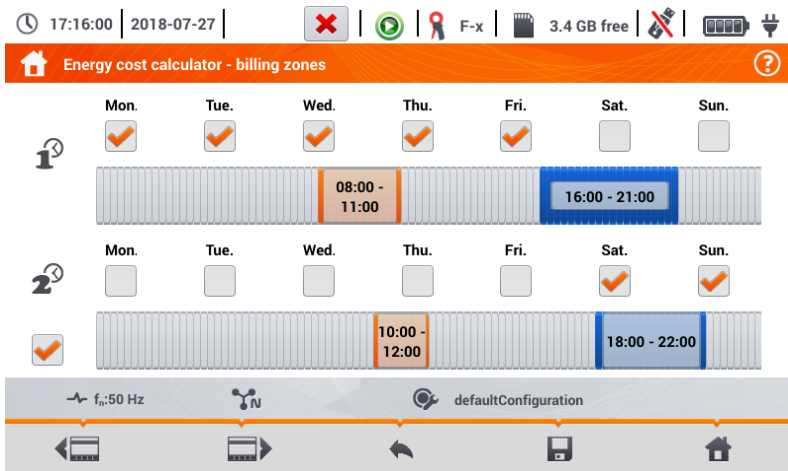

Fig. 5.30 Energy cost calculator – Billing zones in multi-zone tariff

Intervals for zones A and B (respective colours: **orange** and **blue**) may be modified by:

- touching the centre of the time interval and moving it sideways,
- touching and moving the left or the right edge of the interval, changing the limits of the tariff zone.

Start and end time is visible in the middle of the time interval. The **resolution** of time intervals is **15 minutes**. The **minimum duration** of an interval is **2 hours**.

Description of function icons

- switching between the two setting screens of the cost calculator.
- returning to the results indicated by the cost calculator. If the settings have been modified and saved, the energy costs will be automatically calculated and displayed.
- saving the settings in the analyzer memory.
- returning to the main menu of the recorder mode



The settings are global for the entire recorder (not related to a specific recording).

5.9 Energy loss calculator

5.9.1 Functional Description

In this mode, you can estimate the loss of active power and associated costs due to poor power supply quality. The loss analysis screen is shown in **Fig. 5.31**. Analysis can be performed in terms of the desired time.

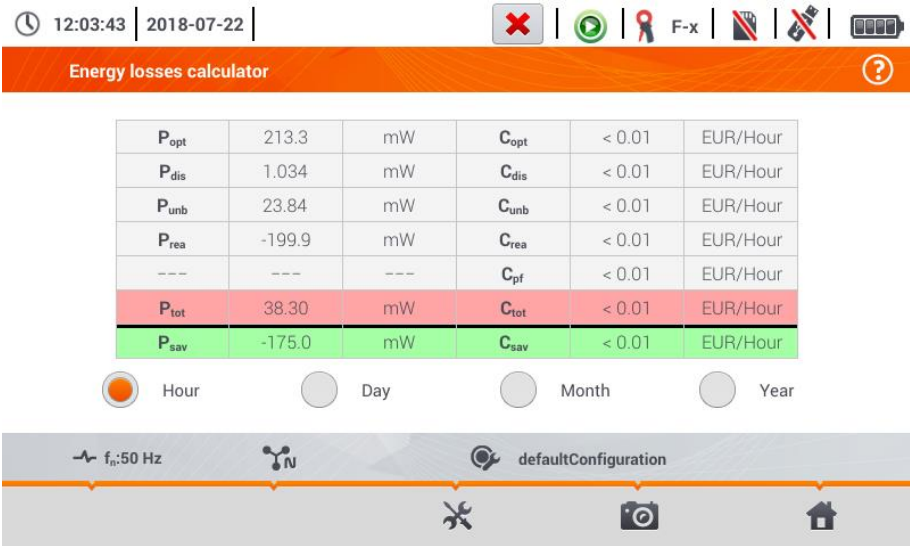

Fig. 5.31 Energy loss analysis

Parameters to analyse

P_{opt} power loss due to wire resistance (assuming the absence of higher harmonics, unbalance and reactive power)

P_{dis} losses due to higher harmonics

P_{unb} power losses due to network unbalance

P_{rea} power loss due to the presence of reactive power

P_{tot} total losses (the sum of the above)

P_{sav} losses which can be reduced by improving the quality parameters (e.g. compensation of harmonics, elimination of unbalance), arising from the relationship:

$$P_{sav} = P_{tot} - P_{opt}$$

C_{opt} cost related to P_{opt} losses

C_{dis} cost related to P_{dis} losses

C_{unb} cost related to P_{unb} losses

C_{rea} cost related to P_{rea} losses

C_{pf} cost related to a low power factor (large share of reactive power)

C_{tot} cost related to P_{rea} losses



C_{sav} cost related to P_{sav} losses

The financial loss can be estimated based on the current readings in terms of:



- ⇒ one hour,
- ⇒ one day,
- ⇒ one month
- ⇒ one year.

When one of the above options is activated ( → ), the table will display data relevant to the selection.

Description of function icons

-  going to the configuration panel of the loss calculator (**section 5.9.2**)
-  performing the screenshot
-  returning to the main menu of the recorder mode

5.9.2 Configuration of the loss calculator

After the  icon has been selected, the calculator configuration panel appears, shown in **Fig. 5.32** and **Fig. 5.33**. It is possible to switch between screens using the   icons.

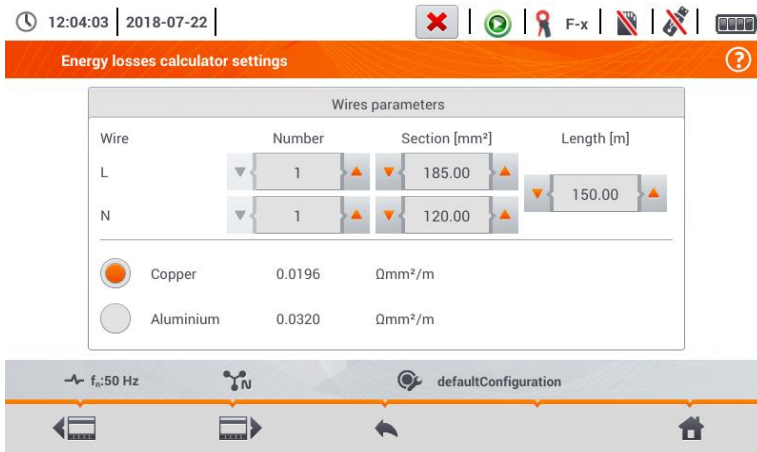

Fig. 5.32 Energy loss analysis – configuration screen 1

On the first screen, set the parameters of the wire, to which the analysis applies, namely:

- for phase conductors **L**:
 - o **number of wires** in the phase,
 - o **cross section** of cores in mm²,
- for neutral conductors **N**:
 - o **number** of neutral wires,
 - o **cross section** of cores in mm²,
- **the length** of the analysed line in metres,
- **line material** – copper or aluminium.

Based on the above parameters, the calculator will calculate the power loss in the analysed line.

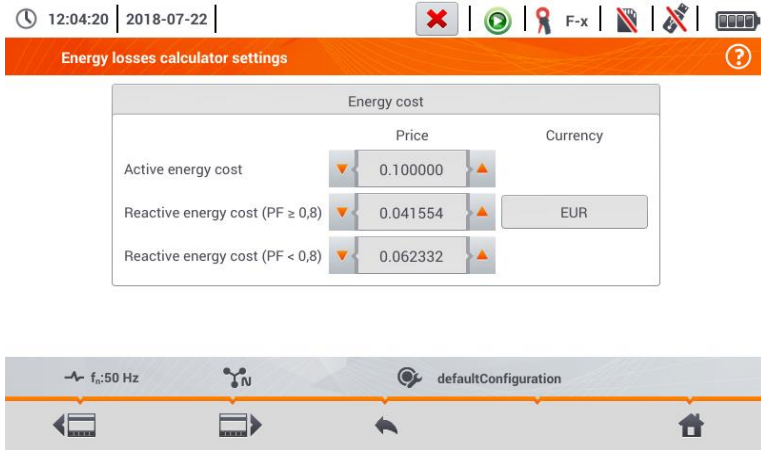

Fig. 5.33 Energy loss analysis – configuration screen 2

On the second screen, set the parameters defining the financial loss, i.e:

- cost of 1 kWh of active energy,
- cost of 1 kWh reactive energy at power factor $PF \geq 0.8$,
- cost of 1 kWh of reactive energy at power factor $PF < 0.8$,
- currency.

To change the currency:

- tap the field with the current unit,
- enter a new unit using the on-screen keyboard.

Description of function icons

switching between the two setting screens of the calculator.

returning to the results indicated by the calculator. If the settings have been modified and saved, the results will be automatically calculated and displayed.

recording calculator settings

returning to the main menu of the recorder mode

5.10 Inverter efficiency

See **sec. 3.20.1, 3.20.2.**

6 Memory of the meter

6.1 Memory of measurements

6.1.1 Memory settings

①  In the main menu select **Settings**.

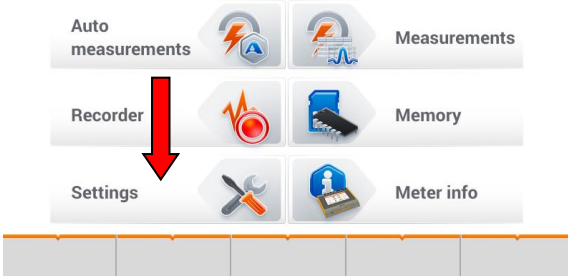

②



Select **Memory settings**.

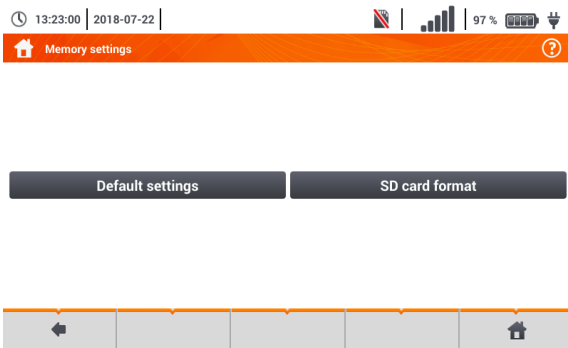

③



Two options will appear.

- **Default settings** – restores the meter memory to default memory settings. When this option has been selected, a prompt will appear asking to confirm the selection.
- **SD card format**. When this option has been selected, a prompt will appear asking to confirm that the user wants to format the SD card.

Description of function icons

-  return to the previous screen
-  return to the main menu

6.1.2 Structure of the memory

The memory of measurement results is of a tree structure (Fig. 6.1). The user can record an unlimited number of clients. Any number of objects with sub-objects can be created in each client.

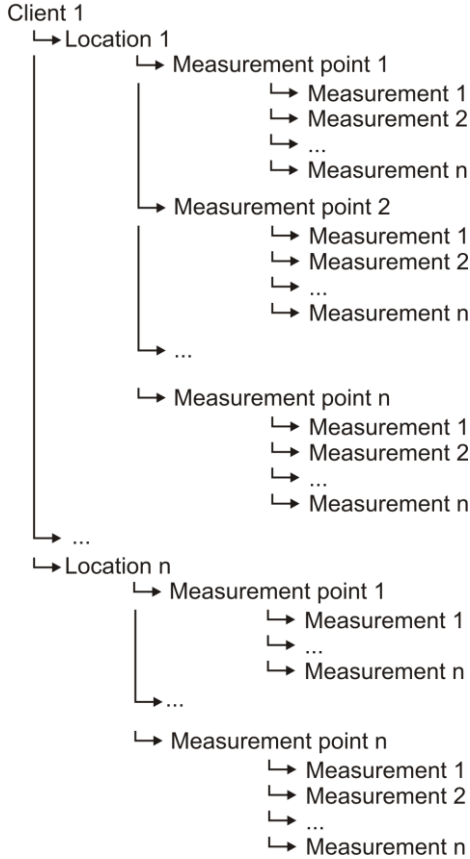
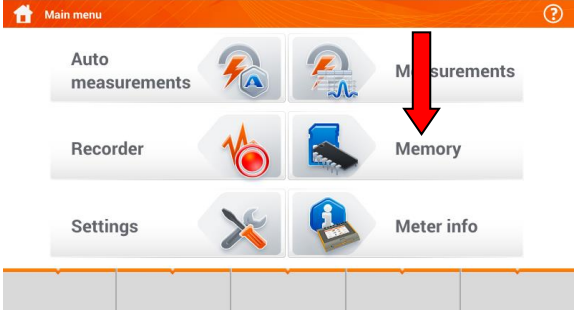

Fig. 6.1. Structure of meter memory for a single client

a. Fundamentals of navigating the Memory menu

1 09:50:16 | 2018-11-15 | 3.7 GB | 93% | Select **Memory** in the main menu.



2 13:25:51 | 2018-07-22 | 98% | Memory management panel will appear.

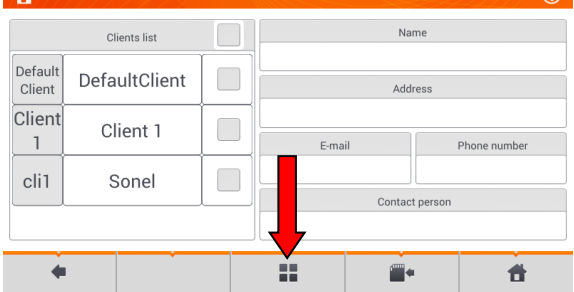

Description of function icons

- item inactive
- item active
- ← returning to the previous screen
- ➡ going to a lower level of the active item
- ✓ going to the folder tree of the active client
- 🏠 returning to the main menu
- 📁 recording the active item to the SD card
- ☰ expanding the active item management menu

3

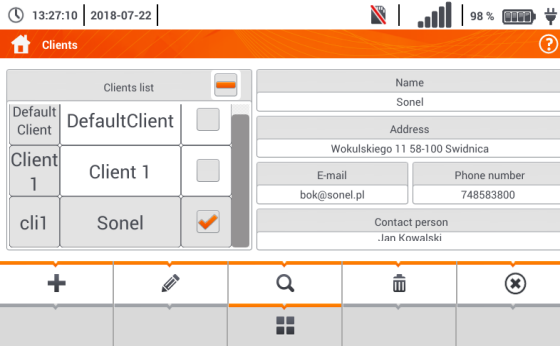

Description of icons in the edit menu

- + adding a new client
- editing the active client
- search mode (**section 6.1.4**)
- removing the active client
- closing the menu

4

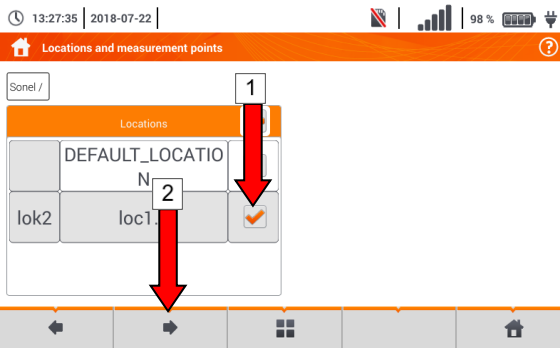

To go to a lower level of the folder tree:

- activate the required item (→)
- select the icon.

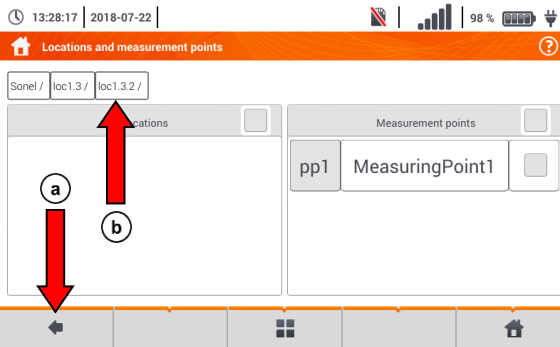

(a) To go to a higher level of the folder tree, select the icon.

(b) To move several levels up, select the name of the required folder on the top navigation bar.

b. Adding a new measurements tree

1

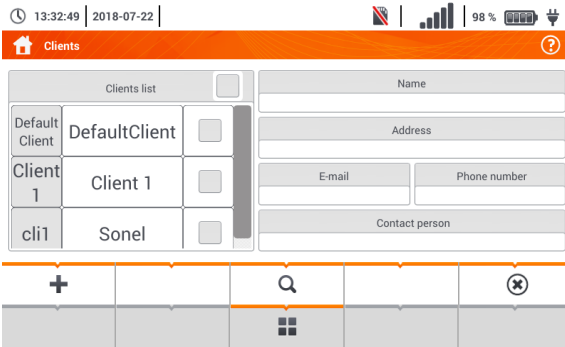

Add a new client using the + icon.

2

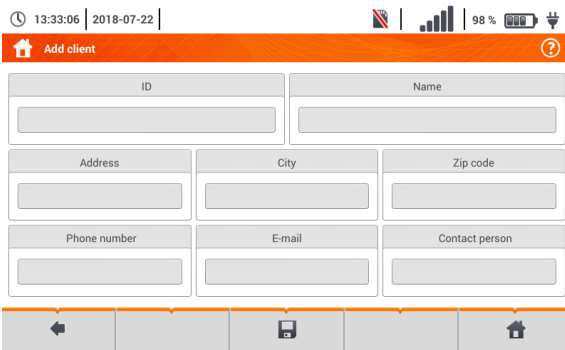

Tap and complete the required fields using the on-screen keyboard:

- ⇒ Client ID,
- ⇒ name,
- ⇒ address:
- ⇒ city,
- ⇒ postal code,
- ⇒ phone number,
- ⇒ e-mail,
- ⇒ contact person.

3

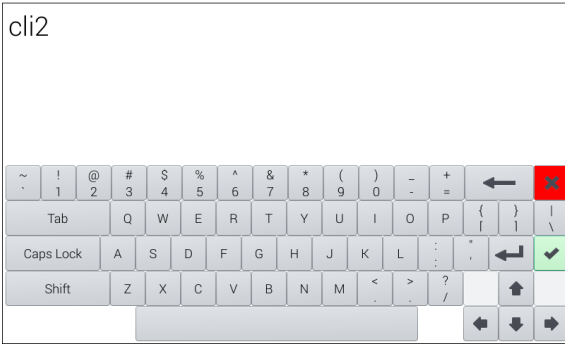



Enter the name from the touch keypad (holding certain buttons for a longer time triggers Polish characters).

Functions of icons

- rejecting changes and returning to step 2
- accepting changes and going to step 4

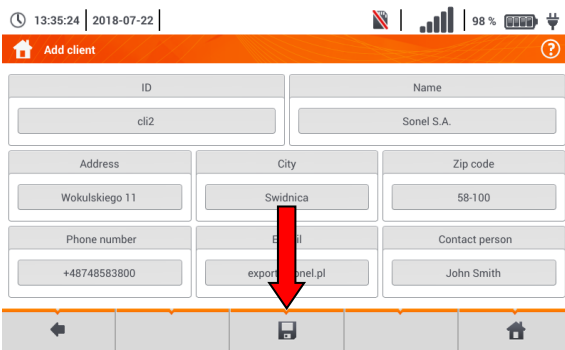



4

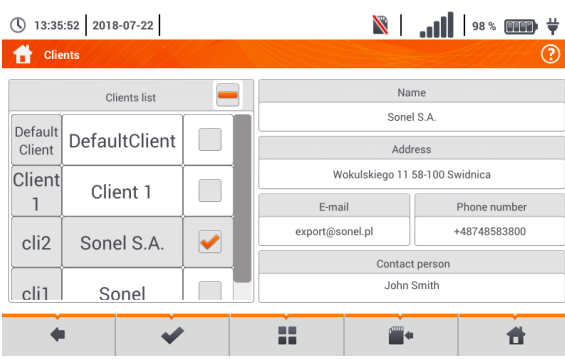

- Save changes using the  icon.
- The display will return to the client management menu.

5



- Tap to activate the selected client ( → .
- Select icon  and  to edit data.
- Further actions are the same as in steps 2, 3, 4.
- To go to the lower level of the tree:
 - ⇒ tap the label of the required item,
 - ⇒ activate the required item and select .

6

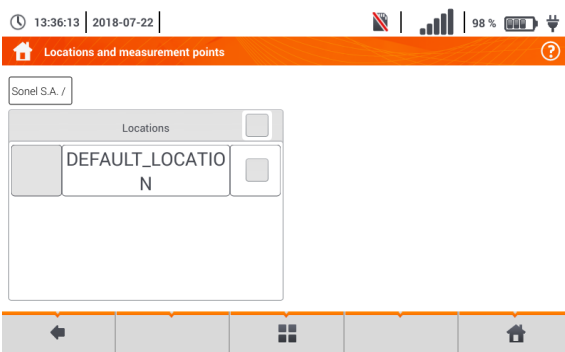

Creating a new client results in creating a default location for the measurements.

7

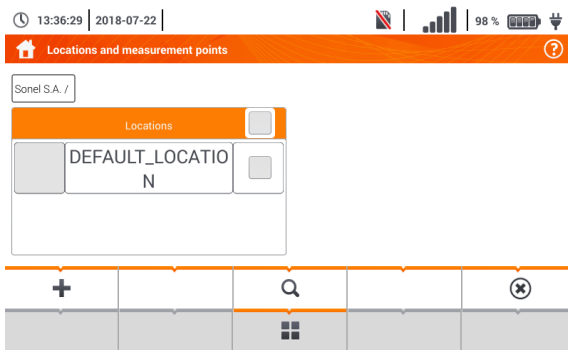

To add a new location:

- tap to activate the **Location** column,
- expand the edit menu using the  icon and select **+**,
- proceed as in steps 2 3.

8

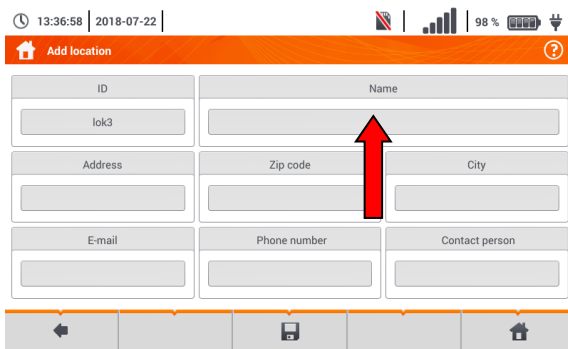

In the **Name** field the list of names for further use may be defined.

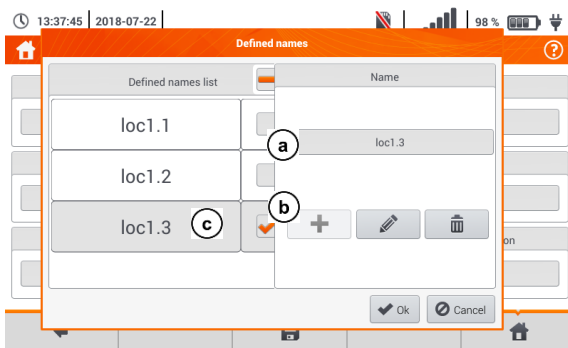

9





a) Tap the name creation field and add a new name, the same as in step 3.

b) Using the **+** icon add the created item to the list of names.

c) Select the required item and using the icons:

-  edit the name,
-  remove the name.

Tap to assign a location from the list to a required location of the tree ( → .

Ok – accept all changes.

Cancel – cancel changes.



10

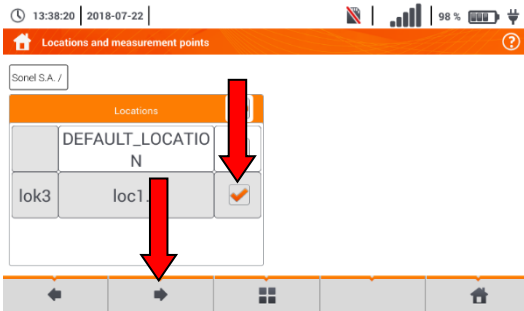

- Save changes using the  icon.
- The display will return to the location management menu.

11



- Activate the required location ( → ).
- Select  to go to the lower level of the tree.



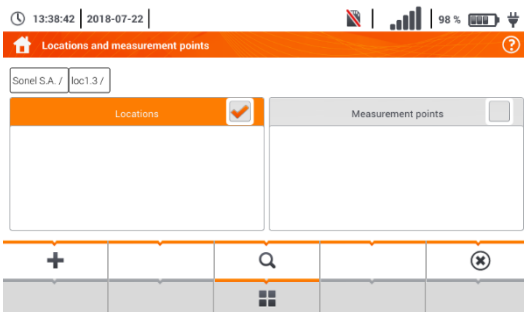



12

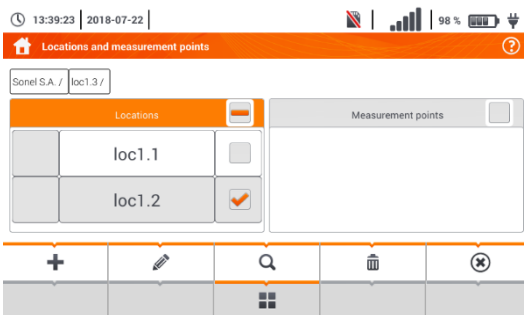

- The screen for locations and measuring points will appear.
- Tap to activate the **Location** column.
 - Expand the edit menu using the  icon and select **+**,
 - Proceed as in steps [2](#) [3](#) [4](#) and [8](#) [9](#) [10](#).

13



- Activate the required location ( → ).
- Using the  icon, go to a lower level of the menu.
- If necessary, repeat steps [12](#) [13](#).
- Using the  icon expand the edit menu and select:
 -  to edit location (as in steps [8](#) [9](#) [10](#)),
 -  to enter the search mode ([section 6.1.4](#)),
 -  remove.

14

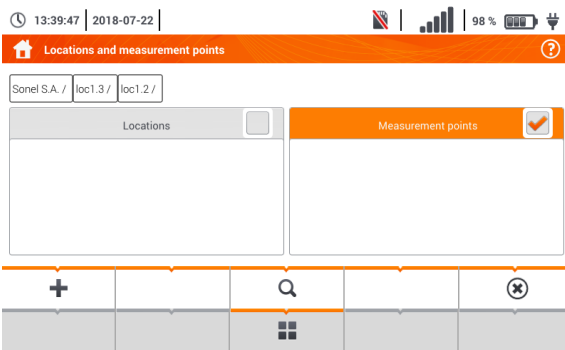

- Activate the column **Measurement points** (☐ → ☑).
- Using the ☐ icon expand the edit menu and select + to add a new measurement point (step 15).

15

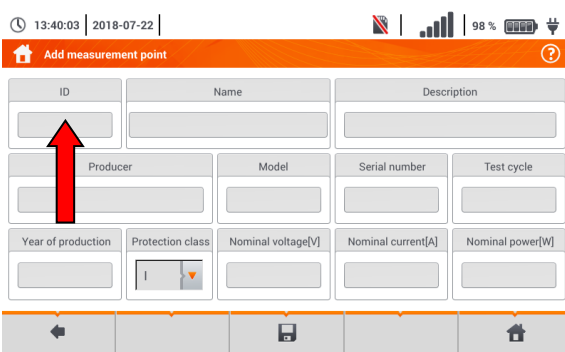

- Tap and complete the required fields using the on-screen keyboard:
- ⇒ point ID,
 - ⇒ name,
 - ⇒ description,
 - ⇒ manufacturer,
 - ⇒ model,
 - ⇒ serial number,
 - ⇒ measuring cycle,
 - ⇒ year of manufacture,
 - ⇒ safety class,
 - ⇒ nominal voltage,
 - ⇒ nominal current,
 - ⇒ nominal power.

Description of function icons

- ← returning to the previous screen
- 💾 saving changes
- 🏠 returning to the main menu

16

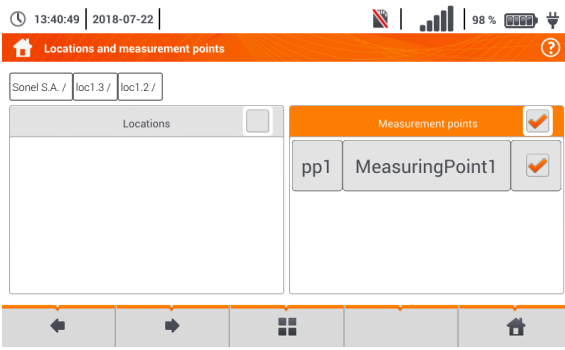

The measuring point has been saved.

Description of icons in the edit menu

- + adding a new point
- ✎ editing the active point
- Q search mode (section 6.1.4)
- 🗑 removing the active point.
- ⊗ closing the menu



- The results of measurements performed for all measuring functions can be stored in one cell of the **Measurement points** column.
- Only the results of measurements activated by pressing the **START** button can be stored in the memory (except autozeroing in low-voltage measurement of resistance).
- Complete set of results (main result and supplementary results) for a given measuring function, preset measurement settings, date and time of the measurement are stored in the memory.

6.1.3 Entering the measurement result

1

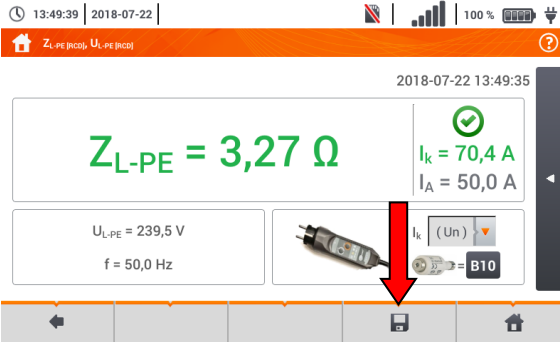

- After the measurement, select the  icon.
- The menu Entering the measurement result will appear (the menu and control the same as in **section 6.1.1**).

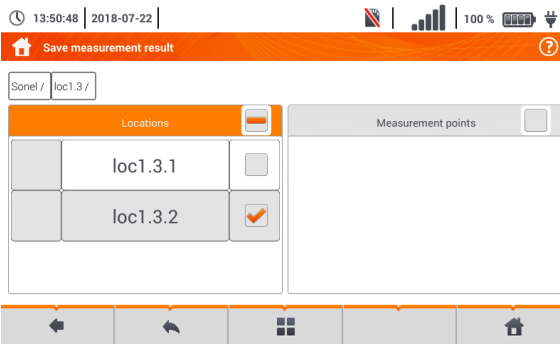

2

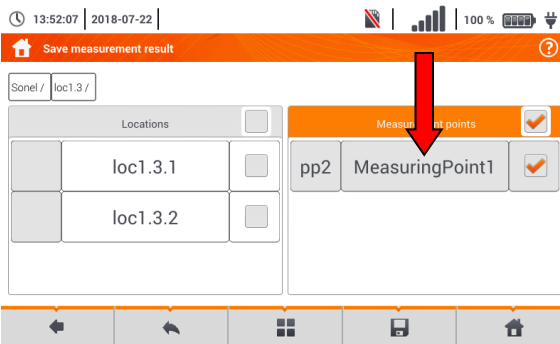

- If necessary, create a new location in accordance with **section 6.1.2b**.

3





- Select the required measurement point from the location or create a new point in accordance with **section 6.1.2b** step (14)(15)(16).
- Tap  to save the result to memory.
- In case of cancellation, return to the measurement menu using the  icon.

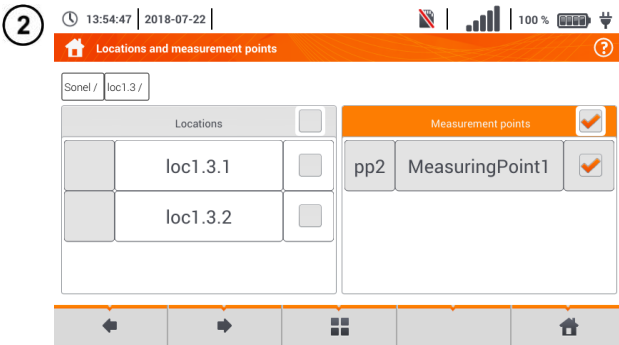
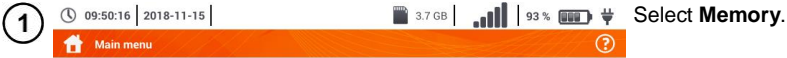

Management of objects and sub-objects is possible both in the saving to memory mode and memory viewing (**section 6.1.4**).

6.1.4 Viewing saved measurements



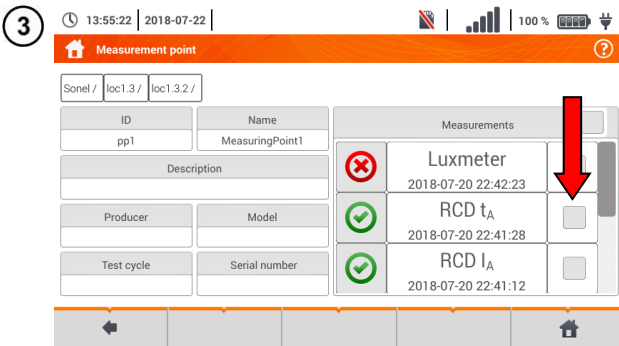

- Go to a location with a measuring point to which the measurement results were saved.
- Activate the required measuring point (→).
- Using the  icon, go to the contents of the measuring point.



The list of measuring points contained in the active point will be displayed.

Description of controls signaling that the set limit has been reached.

-  condition fulfilled
-  condition unfulfilled
-  limit not defined

To call up the measurements management menu, activate the required records (→).

4

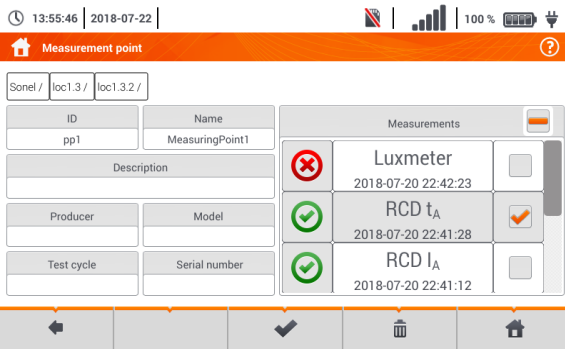

Description of function icons

- returning to the previous screen
- going to details (step 5)
- removing the active record.
- returning to the main menu

5

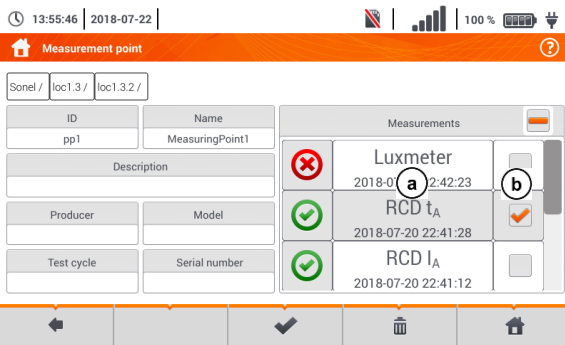

To go to the selected measurement result:

- a) tap the record label,
- b) activate the record (→) and select .

6

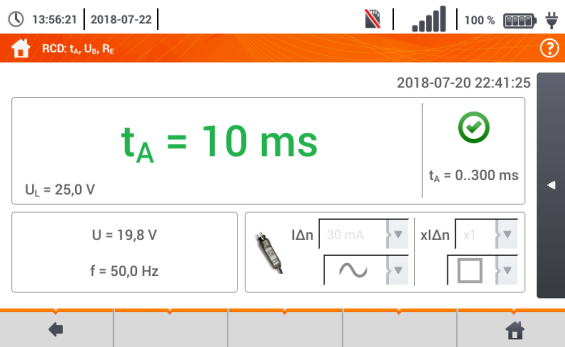



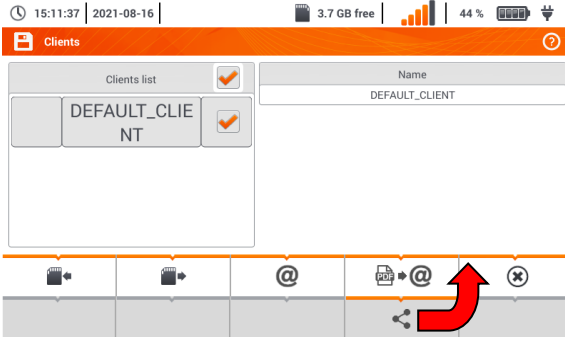

The value of the required measurement will be displayed.

6.1.5 Sharing recorded measurements







- Select . The following options are available:

  import of all clients from the memory card to the meter,

  export of selected clients to a memory card,

@ sending selected customers via e-mail,

  @ generating a report in PDF format and sending it by e-mail.

- If necessary, select the customer (  ) , which is to be subject to the requested action.
- Select the icon with the desired action.



Before sending data by e-mail, the Outbox must be configured. See **sec. 2.3.4**.

6.1.6 Searching the meter memory

1

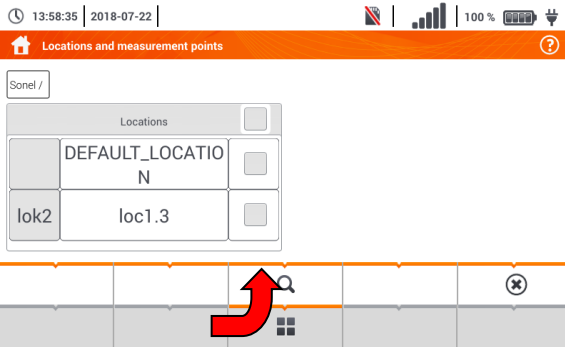

- From anywhere in the browse menu select  and .

2

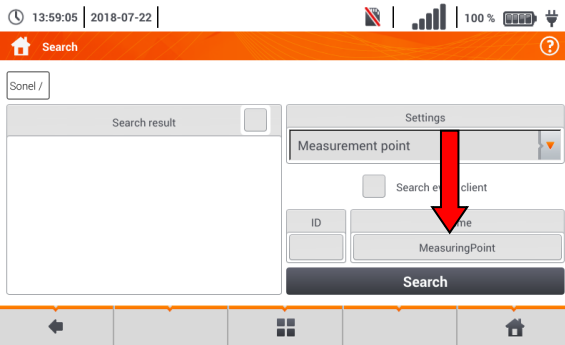

- The search menu will be displayed.

- In the **Settings** field, select the type of the searched object: **location** or **measuring point**.

- If necessary, select **Search all clients** (→)

- In the **Name** field, enter the searched phrase from the on-screen keyboard.

- Select **Search**.

3

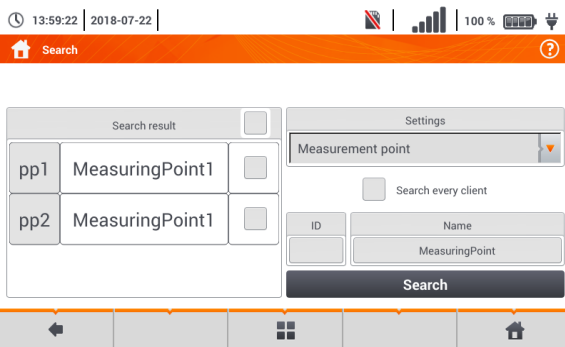



- Activate the required result (→)

- Go to details using the  icon.

- After the  icon has been selected, the option of record editing is also available in accordance with **section 6.1.2b**, steps **8** **9** **10**.

Description of other function icons

 returning to the previous screen

 returning to the main menu

6.2 Recorder memory

6.2.1 microSD Memory Card

Removable microSD HC card is the primary place of data storage. The following are saved on it:

- recorded measurement data,
- screenshot files.

The top bar shows the status of the card and its free space available.

To ensure proper operation of the meter and prevent data loss, do not:

- remove the memory card during recording. Removal of the card may result in **ending the recording process ,damage** of data recorded, and in some cases, **damage to the entire structure of files** saved on the card.
- modify or delete files stored on the card or store your own files on it. If after inserting the card the meter detects an error in the file system, the memory format panel is shown to perform formatting of the card. Only after formatting (which removes all files) it will be possible to reuse the card in the device.

In addition, before removing the card from the meter (e.g. to read the data by *Sonel Analysis*) it is recommended to turn the meter off, to save all cached data.

MicroSD memory card may be formatted from the user interface level. Go to **Analyser settings**, and then select the **Memory** section, where the user can format the selected memory (see also **section 6.1.1**).

6.2.2 USB external memory (flash drive)

Connecting an external USB stick allows user to:

- copy selected files with screenshot from microSD memory card to the memory stick,
- save the log file of the meter, in case of an error in the device in order to perform an analysis in the service of the manufacturer,
- update the firmware of the device.

Supported file systems are FAT32. When a memory formatted in a different file system is inserted, the device will display a window informing about detecting unformatted media carrier. From this window, the user may directly enter the formatting screen.

The data on the memory stick are stored in the folder named " MPI-540_DATA".

6.2.3 Compatibility with *Sonel Analysis* software



Sonel Analysis is an application used to work with MPI-540 meter and power analyzers of PQM series. In combination with the above devices it enables to:

- read data from the device,
- present data in the tabular form,
- present data in the form of graphs,
- updating firmware of analyzer to new and updating the application itself.

The software operates with Windows XP, Windows Vista, Windows 7, Windows 8 and Windows 10. Detailed manual for "*Sonel Analysis*" is available in a separate document (also downloadable from the manufacturer's website).

6.2.4 PC connection and data transmission

Connection to a computer (PC mode), ensures transmission of data stored in the recorder memory – it is possible to read data from all completed recordings.

- When connected to a PC, the display shows message "PC Connection"
- When connected to a PC, all buttons are locked except  button, unless the recorder operates with key lock mode (e.g. during recording) – then all the buttons are locked. The  icon whose selection interrupts the connection with the PC is displayed on the screen on the bottom bar.
- When within 10 seconds of connecting a PC to the device no data exchange occurs between the device and the computer, the device exits data exchange mode and terminates the connection.







Sonel Analysis software also allows you to read data directly from a microSD card using an external memory card reader. This method allows for the fastest reading of the recorded data. To use this mode, remove the memory card from the meter and put it into the reader connected to a computer (when removing the card, follow the rules described in **sec. 6.2.1**; it is safe to turn the meter off earlier).

7 Power supply

7.1 Monitoring of the battery charge status

The device is equipped with a Li-Ion battery pack 11.1 V 3.4 Ah. The battery pack includes a circuit monitoring its charge status, which provides precise level of battery pack charge and a temperature sensor.

The charging level of the battery pack is indicated by icon on the top bar of the screen on the right side (section 2 element 2).

	charging level 80...100%
	charging level 60...80%
	charging level 40...60%
	charging level 20...40%
	charging level 0...20%
	<ul style="list-style-type: none">• batteries fully discharged.• no battery• no communication with the battery pack

7.2 Replacing rechargeable batteries

MPI-540 meter is powered from SONEI Li-Ion rechargeable battery pack.

Battery charger is installed inside the meter and cooperates only with the manufacturer's rechargeable battery pack. The charger is powered by external power supply adapter. It can be also powered from the car cigarette lighter socket. Both the rechargeable battery pack and the adapter are standard components of the meter.



WARNING

If the test leads are left in the terminals during replacement of the batteries, there is a risk of electric shock.

The internal real time clock is supplied from the battery pack, therefore to avoid deleting the clock settings, the battery pack replacement may be performed with connected power supply of 12 V DC.

In order to replace the battery pack it is necessary to:

- remove all the test leads from the sockets and turn the meter off,
- connect the external power supply 12 V DC (to prevent deleting date and time settings)
- remove the four screws of the battery compartment (in the lower part of the casing, **Fig. 7.1**),
- remove the battery compartment,
- remove the compartment cover and remove the batteries,
- insert a new battery pack,
- Insert (snap) the compartment cover,
- Insert the compartment in the meter,
- screw the 4 screws of the battery compartment.

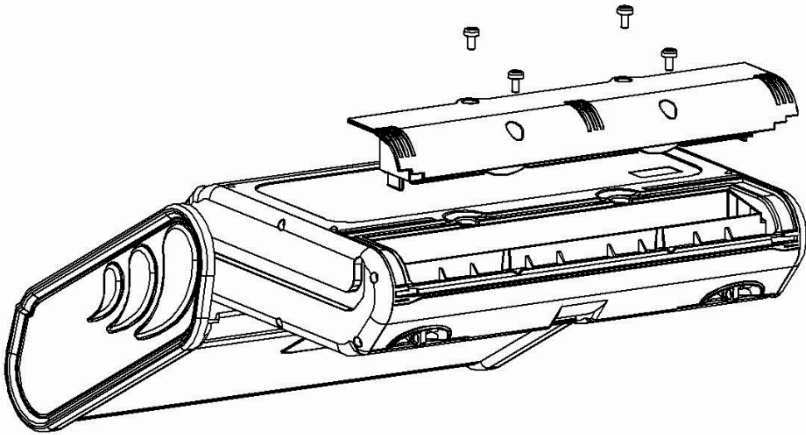

Fig. 7.1. Replacing the battery pack



NOTE!

Do not use the meter when the accumulator compartment is removed or open or power it from other sources than those mentioned in this manual.

7.3 Charging the rechargeable batteries

Charging the battery pack of the device is started automatically after connecting:



- 2 V DC power supply adapter,
- charging cable for the car cigarette lighter.

Charging is indicated by the  icon next to the battery symbol on the top bar and by the **H.V./REC/CONT.** diode. The temperature of the battery and the ambient temperature influence the charging process. If the battery temperature is below 0°C or higher than 45°C, the charging process is stopped.

Indication of charging status

- charging

meter off – diode **H.V./REC/CONT.** is lit **green**  

meter on – charging signalled only by an icon on the display  

- damage

meter off – diode **H.V./REC/CONT.** flashes **green** every 0.5 second  

meter on – error signalled by an icon on the display 



Due to interferences in the network or to high ambient temperature, the charging process of rechargeable batteries may finish prematurely. When charging time is too short, turn off the meter and start charging again.

7.4 General rules for using Li-Ion rechargeable batteries

- Store the half-charged battery pack in a plastic container placed in a dry, cool and well ventilated place and protect them from direct sunlight. The battery pack may be damaged if stored when fully discharged. The ambient temperature for prolonged storage should be maintained within the range of 5°C...25°C.
- Charge the batteries in a cool, well-ventilated place at a temperature of 10°C ... 28°C. Modern fast chargers detect both too low and too high temperature of rechargeable batteries and react to the situation adequately. When the temperature is too low, charging should be prevented as it may irreparably damage the batteries. The increase in temperature of the battery pack may cause electrolyte leakage and even its ignition or explosion.
- Do not exceed the charging current, as it may result in ignition or "swelling" of the battery pack. "Swollen" battery pack must not be used.
- Do not charge or use the batteries in extreme temperatures. Extreme temperatures reduce the lifetime of rechargeable batteries. Always observe the rated operating temperature. Do not dispose the battery pack into fire.
- Li-Ion cells are sensitive to mechanical damage. This kind of damage may cause their permanent damage and thus - ignition or explosion.
- Any interference in the structure of Li-ion battery pack may cause its damage. This may result in the ignition or explosion.
- A short-circuit of the battery poles "+" and "-" may permanently damage the battery pack or even cause its fire or explosion.
- Do not immerse Li-Ion battery in liquids and do not store in humid conditions.
- If the electrolyte contained in the Lithium-Ion battery pack, contacts eyes or skin, immediately rinse the affected place with plenty of water and consult a doctor. Protect the battery against unauthorised persons and children.
- When you notice any changes in the Lithium-Ion battery pack (e.g. changes in colour, swelling, excessive temperature), stop using the battery pack. Li-Ion batteries that are mechanically damaged, overcharged or excessively discharged are not suitable for use.
- Any misuse of the battery may cause its permanent damage. This may result in the ignition. The seller and the manufacturer shall not be liable for any damages resulting from improper handling Li-Ion battery pack.

8 Cleaning and maintenance



NOTE!

Use only the maintenance methods specified by the manufacturer in this manual.

The meter has been designed for many years of reliable use, provided that the following recommendations are observed for its maintenance and care:

1. **THE METER MUST BE DRY.** Wipe the dampened meter.
2. **THE METER MUST BE USED AND STORED IN NORMAL TEMPERATURES.** Extreme temperatures may shorten the life of electronic components and distort or melt plastic parts.
3. **THE METER MUST BE HANDLED CAREFULLY AND GENTLY.** Dropping the meter may damage its electronic elements or the housing.
4. **THE METER MUST BE KEPT CLEAN.** From time to time wipe the housing with a damp cloth. DO NOT use chemicals, solvents or detergents.
5. **CLEAN THE PROBES WITH WATER AND DRY THEM** Before the probe is stored for a prolonged period of time it is recommended to grease it with any machine lubricant.
6. The reels and test leads should be cleaned with water and detergents, and then dried.



The electronic system of the meter does not require maintenance.

9 Storage

In the case of storage of the device, the following recommendations must be observed:

- Disconnect all the test leads from the meter.
- Clean the meter and all its accessories thoroughly.
- Wind the long test leads onto the reels.
- In the case the meter is to be stored for a prolonged period of time, the batteries must be removed from the device.
- In order to prevent a total discharge of the rechargeable batteries in the case of a prolonged storage, charge them from time to time.

10 Dismantling and utilisation

Worn-out electric and electronic equipment should be gathered selectively, i.e. it must not be placed with waste of another kind.

Worn-out electronic equipment should be sent to a collection point in accordance with the law of waste electrical and electronic equipment.

Before the equipment is sent to a collection point, do not dismantle any elements. Observe the local regulations concerning disposal of packages and used batteries/rechargeable batteries.

11 Technical data

11.1 Basic data

⇒ Abbreviation "m.v." used in the specification of accuracy means standard measured value

11.1.1 Measurement of alternating voltages (True RMS)

Range	Resolution	Accuracy
0.0 V...299.9 V	0.1 V	±(2% m.v. + 4 digits)
300 V...500 V	1 V	±(2% m.v. + 2 digits)

- Frequency range: 45...65 Hz

11.1.2 Frequency measurement

Range	Resolution	Accuracy
45.0 Hz...65.0 Hz	0.1 Hz	±(0.1% m.v. + 1 digit)

- Voltage range: 50 ... 500V

11.1.3 Measurement of fault loop impedance Z_{L-PE} , Z_{L-N} , Z_{L-L}

Measurement of fault loop impedance Z_s

Test range according to IEC 61557-3:

Test lead	Test range Z_s
1.2 m	0.130 Ω...1999.9 Ω
5 m	0.170 Ω...1999.9 Ω
10 m	0.210 Ω...1999.9 Ω
20 m	0.290 Ω...1999.9 Ω
WS-03, WS-04	0.190 Ω...1999.9 Ω

Display range:

Display range	Resolution	Accuracy
0.000...19.999 Ω	0.001 Ω	±(5% m.v. + 0.03 Ω)
20.00...199.99 Ω	0.01 Ω	±(5% m.v. + 0.3 Ω)
200.0...1999.9 Ω	0.1 Ω	±(5% m.v. + 3 Ω)

- Rated operating voltage U_{nL-N} / U_{nL-L} : 110/190 V, 115/200 V, 127/220 V, 220/380 V, 230/400 V, 240/415 V
- Operating voltage range: 95 V...270 V (for Z_{L-PE} and Z_{L-N}) and 95 V...440 V (for Z_{L-L})
- Rated mains frequency f_n : 50 Hz, 60 Hz
- Operating frequency range: 45 Hz...65 Hz
- Maximum test current (for 415 V): 41.5 A (10 ms)
- Control of correctness of PE terminal connection by means of a touch electrode

Indications of fault loop resistance R_S and fault loop reactance X_S

Display range	Resolution	Accuracy
0...19.999 Ω	0.001 Ω	$\pm(5\% + 0.05 \Omega)$ of Z_S value

- Calculated and displayed for $Z_S < 20 \Omega$

Indications of short-circuit current I_k

Test range according to IEC 61557-3 can be calculated on the basis of test ranges for Z_S and nominal voltages.

Display range	Resolution	Accuracy
0.055 ...1.999 A	0.001 A	Calculated on the basis of accuracy for fault loop
2.00...19.99 A	0.01 A	
20.0...199.9 A	0.1 A	
200...1999 A	1 A	
2.00...19.99 kA	0.01 kA	
20.0 ...40.0 kA	0.1 kA	

- Prospective fault current calculated and displayed by the meter may slightly differ from the value calculated by the user with a calculator, basing on the displayed value of the impedance, because the meter calculates the current from unrounded value of fault loop impedance (which is used for displaying). As the correct value, consider I_k current value, displayed by the meter or by firmware.

11.1.4 Measurement of fault loop impedance $Z_{L-PE[RCD]}$ (without triggering of RCD)

Measurement of fault loop impedance Z_S

Test range according to IEC 61557-3:

- 0.50...1999 Ω for 1.2 m leads, WS-03 and WS-04
- 0.51...1999 Ω for 5 m, 10 m and 20 m leads

Display range	Resolution	Accuracy
0...19.99 Ω	0.01 Ω	$\pm(6\% \text{ m.v.} + 10 \text{ digits})$
20.0...199.9 Ω	0.1 Ω	$\pm(6\% \text{ m.v.} + 5 \text{ digits})$
200...1999 Ω	1 Ω	

- It will not trip RCDs of $I_{\Delta n} \geq 30 \text{ mA}$
- Rated operating voltage U_n : 110 V, 115 V, 127 V, 220 V, 230 V, 240 V
- Operating voltage range: 95 V...270 V
- Rated mains frequency f_n : 50 Hz, 60 Hz
- Operating frequency range: 45...65 Hz
- Control of correctness of PE terminal connection by means of a touch electrode

Indications of fault loop resistance R_S and fault loop reactance X_S

Display range	Resolution	Accuracy
0..19.99 Ω	0.01 Ω	$\pm(6\% + 10 \text{ digits})$ of Z_S value

- Calculated and displayed for $Z_S < 20 \Omega$

Indications of short-circuit current I_k

Test range according to IEC 61557-3 can be calculated on the basis of test ranges for Z_s and nominal voltages.

Display range	Resolution	Accuracy
0.055 ... 1.999 A	0.001 A	Calculated on the basis of accuracy for fault loop
2.00...19.99 A	0.01 A	
20.0...199.9 A	0.1 A	
200...1999 A	1 A	
2.00...19.99 kA	0.01 kA	
20.0 ... 40.0 kA	0.1 kA	

- Prospective fault current calculated and displayed by the meter may slightly differ from the value calculated by the user with a calculator, basing on the displayed value of the impedance, because the meter calculates the current from unrounded value of fault loop impedance (which is used for displaying). As the correct value, consider I_k current value, displayed by the meter or by firmware.

11.1.5 Measurement of parameters of RCD

- Measurement of RCDs type: AC, A, B, B+, F, EV
- Rated operating voltage U_n : 110 V, 115 V, 127 V, 220 V, 230 V, 240 V
- Operating voltage range: 95 V...270 V
- Rated mains frequency f_n : 50 Hz, 60 Hz
- Operating frequency range: 45...65 Hz

RCD trigger and response time test t_A (for measurement function t_A)

Test range according to IEC 61557-6: 0ms ... to the upper limit of displayed value

Type of RCD	Setting of multiple values	Test range	Resolution	Accuracy
<ul style="list-style-type: none"> • General type • Short-time delay type • AC module in EV type 	0.5 $I_{\Delta n}$	0..300 ms (TN/TT)	1 ms	$\pm(2\% \text{ m.v.} + 2 \text{ digits})^1)$
	1 $I_{\Delta n}$	0..400 ms (IT)		
	2 $I_{\Delta n}$	0..150 ms		
	5 $I_{\Delta n}$	0..40 ms		
Selective	0.5 $I_{\Delta n}$	0..500 ms		
	1 $I_{\Delta n}$			
	2 $I_{\Delta n}$	0..200 ms		
	5 $I_{\Delta n}$	0..150 ms		
<ul style="list-style-type: none"> • EV 6 mA DC • RCM 	1 $I_{\Delta n}$	0.0..10.0 s	0.1 s	$\pm(2\% \text{ m.v.} + 3 \text{ digits})$
	10 $I_{\Delta n}$	0..300 ms	1 ms	
	33 $I_{\Delta n}$ ²⁾	0..100 ms		
	50 $I_{\Delta n}$ ³⁾	0..40 ms		

1) for $I_{\Delta n} = 10 \text{ mA}$ and $0.5 I_{\Delta n}$ accuracy is $\pm(2\% \text{ m.v.} + 3 \text{ digits})$

2) for measurements acc. to IEC 62955









3) for measurements acc. to IEC 62752









- Accuracy of differential current setting:

for $1 \cdot I_{\Delta n}$, $2 \cdot I_{\Delta n}$, $5 \cdot I_{\Delta n}$ 0..8%

for $0.5 \cdot I_{\Delta n}$ -8..0%

Effective value of forced leakage current at measurement of RCD disconnection time (does not apply to RCD EV 6 mA DC and RCM) [mA]

$I_{\Delta n}$	Multiplication factor setting							
	0.5				1			
								
10	5	3.5	3.5	5	10	20	20	20
30	15	10.5	10.5	15	30	42	42	60
100	50	35	35	50	100	140	140	200
300	150	105	105	150	300	420	420	600
500	250	175	175	—	500	700	700	1000*
1000	500	—	—	—	1000	—	—	—

$I_{\Delta n}$	Multiplication factor setting							
	2				5			
								
10	20	40	40	40	50	100	100	100
30	60	84	84	120	150	210	210	300
100	200	280	280	400	500	700	700	1000*
300	600	840	840	—	—	—	—	—
500	1000	—	—	—	—	—	—	—
1000	—	—	—	—	—	—	—	—

* - does not apply to $U_n = 110 \text{ V}$, 115 V and 127 V and IT network

Effective value of forced leakage current at measurement of RCD disconnection time (applies to RCD EV 6 mA DC and RCM) [mA]

$I_{\Delta n}$	Multiplication factor setting			
	1	10	33	50
6 mA DC acc. to IEC 62955	6	60	200	—
6 mA DC acc. to IEC 62752	6	60	—	300

Measurement of resistance-to-earth R_E (for TT)

Selected nominal current of RCD	Test range	Resolution	Test current	Accuracy
10 mA	0.01...5.00 k Ω	0.01 k Ω	4 mA	0..+10% m.v. ± 8 digits
30 mA	0.01...1.66 k Ω		12 mA	0..+10% m.v. ± 5 digits
100 mA	1...500 Ω	1 Ω	40 mA	0..+5% m.v. ± 5 digits
300 mA	1...166 Ω		120 mA	
500 mA	1...100 Ω		200 mA	
1000 mA	1...50 Ω		400 mA	

Measurement of touch voltage U_B in relation to nominal differential current

Test range according to IEC 61557-6: 10.0 V...99.9 V

Test range	Resolution	Test current	Accuracy
0...9.9 V	0.1 V	0.4 x $I_{\Delta n}$	0%...10% m.v. ± 5 digits
10.0...99.9 V			0%...15% m.v.

Measurement of RCD disconnection current I_A for sinusoidal differential current

Test range according to IEC 61557-6: $(0.3...1.0)I_{\Delta n}$

Selected nominal current of RCD	Test range	Resolution	Test current	Accuracy
10 mA	3.0..10.0 mA	0.1 mA	$0.3 \times I_{\Delta n}..1.0 \times I_{\Delta n}$	$\pm 5\% I_{\Delta n}$
30 mA	9.0 .. 30.0 mA			
100 mA	30..100 mA	1 mA		
300 mA	90..300 mA			
500 mA	150..500 mA			
1000 mA	300..1000 mA			

- it is possible to start the measurement from the positive or the negative half of forced leakage current
- test current duration..... max. 8.8 s

Measurement of RCD disconnection current I_A for differential unidirectional pulsed current and unidirectional pulsed current with 6mA direct current offset

Test range according to IEC 61557-6: $(0.35...1.4)I_{\Delta n}$ for $I_{\Delta n} \geq 30$ mA and $(0.35...2)I_{\Delta n}$ for $I_{\Delta n} = 10$ mA

Selected nominal current of RCD	Test range	Resolution	Test current	Accuracy
10 mA	3.5..20.0 mA	0.1 mA	$0.35 \times I_{\Delta n}..2.0 \times I_{\Delta n}$	$\pm 10\% I_{\Delta n}$
30 mA	10.5..42.0 mA			
100 mA	35..140 mA	1 mA	$0.35 \times I_{\Delta n}..1.4 \times I_{\Delta n}$	
300 mA	105..420 mA			
500 mA	175..700 mA			

- measurement may be performed for positive or negative half-periods of forced leakage current
- test current duration..... max. 8.8 s

Measurement of RCD disconnection current I_A for differential direct current

Test range according to IEC 61557-6: $(0.2...2)I_{\Delta n}$

Selected nominal current of RCD	Test range	Resolution	Current	Accuracy
6 mA ¹⁾	1.0..6.0 mA	0.1 mA	1.0..6.0 mA	$\pm 6\% I_{\Delta n}$
10 mA	2.0..20.0 mA	0.1 mA		
30 mA	6..60 mA	1 mA	$0.2 \times I_{\Delta n}..2.0 \times I_{\Delta n}$	$\pm 10\% I_{\Delta n}$
100 mA	20..200 mA			
300 mA	60..600 mA			
500 mA	100..1000 mA			

- measurement can be performed for positive or negative forced leakage current
- test current duration (does not apply to RCD EV and RCM)..... max. 5.2 s
- 1) test current duration (applies to RCD EV and RCM)
 - acc. to IEC 62955.....30 s
 - acc. to IEC 62752.....40 s

11.1.6 Measurement of resistance-to-earth R_E

Test range according to IEC 61557-5: 0.50 Ω ...1.99 k Ω for test voltage of 50 V and 0.56 Ω ...1.99 k Ω for test voltage of 25 V

Range	Resolution	Accuracy
0.00...0.35 Ω	0.01 Ω	$\pm(2\% \text{ m.v.} + 10 \text{ digits})$
0.35...9.99 Ω	0.01 Ω	$\pm(2\% \text{ m.v.} + 4 \text{ digits})$
10.0...99.9 Ω	0.1 Ω	$\pm(2\% \text{ m.v.} + 3 \text{ digits})$
100...999 Ω	1 Ω	
1.00...1.99 k Ω	0.01 k Ω	

- test voltage: 25 V or 50 V rms
- test current: 20 mA, sinusoidal rms 125 Hz (for $f_n=50$ Hz) and 150 Hz (for $f_n=60$ Hz)
- blocking of measurement at interference voltage of $U_N > 24$ V
- maximum measured voltage of interferences $U_{Nmax}=100$ V
- maximum resistance of auxiliary earth electrodes 50 k Ω

Measurement of resistance of auxiliary earth electrodes R_H , R_S

Display range	Resolution	Accuracy
000...999 Ω	1 Ω	$\pm(5\% (R_S + R_E + R_H) + 3 \text{ digits})$
1.00...9.99 k Ω	0.01 k Ω	
10.0...50.0 k Ω	0.1 k Ω	

Measurement of interference voltages

Internal resistance: approx. 8 M Ω

Range	Resolution	Accuracy
0...100 V	1 V	$\pm(2\% \text{ m.v.} + 3 \text{ digits})$

Selective measurement of earthing with clamps

Range	Resolution	Accuracy*
0.00...0.35 Ω	0.01 Ω	$\pm(8\% \text{ m.v.} + 10 \text{ digits})$
0.35...9.99 Ω	0.01 Ω	$\pm(8\% \text{ m.v.} + 4 \text{ digits})$
10.0...99.9 Ω	0.1 Ω	
100...999 Ω	1 Ω	
1.00...1.99 k Ω	0.01 k Ω	

* – at maximum interference current of 1 A

- Measurement with additional current clamps C-3,
- The range of interference current is up to 9.99 A.

Selective measurement of earthing with two clamps

Range	Resolution	Accuracy*
0.00...0.35 Ω	0.01 Ω	$\pm(10\% \text{ m.v.} + 10 \text{ digits})$
0.35...9.99 Ω	0.01 Ω	$\pm(10\% \text{ m.v.} + 4 \text{ digits})$
10.0...19.9 Ω	0.1 Ω	
20.0...99.9 Ω		$\pm(20\% \text{ m.v.} + 4 \text{ digits})$

* – at maximum interference current of 1 A

- Measurement with transmitting clamps N-1 and receiving clamps C-3.
- The range of interference current is up to 9.99 A.

Measuring soil resistivity (ρ)

Range	Resolution	Accuracy
0.0...99.9 Ω m	0.1 Ω m	Depending on the accuracy of the measurement R_E
100...999 Ω m	1 Ω m	
1.00...9.99 k Ω m	0.01 k Ω m	
10.0...99.9 k Ω m	0.1 k Ω m	

- Measurement with Wenner method,
- Option for setting the distance in meters or feet,
- Selecting a distance: 1 m ... 30 m (1 ft ... 90 ft).

11.1.7 Low-voltage measurement of continuity of circuit and resistance

Measurement of continuity of protective conductors and equipotential bonding with 200 mA \pm current

Measurement range according to IEC 61557-4: 0.12...400 Ω

Range	Resolution	Accuracy
0.00...19.99 Ω	0.01 Ω	$\pm(2\% \text{ m.v.} + 3 \text{ digits})$
20.0...199.9 Ω	0.1 Ω	
200...400 Ω	1 Ω	

- Voltage at open terminals: 4 V...9 V
- Output current at $R < 2 \Omega$: min. 200 mA (I_{sc} : 200 mA...250 mA)
- Compensation of test leads resistance
- Measurements for both current polarizations

Measurement of resistance with low current

Range	Resolution	Accuracy
0.0...199.9 Ω	0.1 Ω	$\pm(3\% \text{ m.v.} + 3 \text{ digits})$
200...1999 Ω	1 Ω	

- Voltage at open terminals: 4 V...9 V
- Output current < 8 mA
- Audio signal for measured resistance < 30 $\Omega \pm 50\%$
- Compensation of test leads resistance

11.1.8 Measurement of insulation resistance

Measurement range, according to IEC 61557-2 for $U_N = 50 \text{ V}$: 50 k Ω ...250 M Ω

Display range for $U_N = 50 \text{ V}$	Resolution	Accuracy
0 k Ω ...1999 k Ω	1 k Ω	$\pm(3\% \text{ m.v.} + 8 \text{ digits})$, $[\pm(5\% \text{ m.v.} + 8 \text{ digits})]$ *
2.00 M Ω ...19.99 M Ω	0.01 M Ω	
20.0 M Ω ...199.9 M Ω	0.1 M Ω	
200 M Ω ...250 M Ω	1 M Ω	

* – for WS-03 and WS-04 leads

Test range according to IEC 61557-2 for $U_N = 100 \text{ V}$: 100 k Ω ...500 M Ω

Display range for $U_N = 100 \text{ V}$	Resolution	Accuracy
0 k Ω ...1999 k Ω	1 k Ω	$\pm(3\% \text{ m.v.} + 8 \text{ digits})$ $[\pm(5\% \text{ m.v.} + 8 \text{ digits})]$ *
2.00 M Ω ...19.99 M Ω	0.01 M Ω	
20.0 M Ω ...199.9 M Ω	0.1 M Ω	
200 M Ω ...500 M Ω	1 M Ω	

* – for WS-03 and WS-04 leads

Test range according to IEC 61557-2 for $U_N = 250 \text{ V}$: 250 k Ω ...999 M Ω

Display range for $U_N = 250 \text{ V}$	Resolution	Accuracy
0 k Ω ...1999 k Ω	1 k Ω	$\pm(3\% \text{ m.v.} + 8 \text{ digits})$ $[\pm(5\% \text{ m.v.} + 8 \text{ digits})]$ *
2.00 M Ω ...19.99 M Ω	0.01 M Ω	
20.0 M Ω ...199.9 M Ω	0.1 M Ω	
200 M Ω ...999 M Ω	1 M Ω	

* – for WS-03 and WS-04 leads

Test range according to IEC 61557-2 dla $U_N = 500 \text{ V}$: 500 k Ω ...2.00 G Ω

Display range for $U_N = 500 \text{ V}$	Resolution	Accuracy
0...1999 k Ω	1 k Ω	$\pm(3\% \text{ m.v.} + 8 \text{ digits})$ $[\pm(5\% \text{ m.v.} + 8 \text{ digits})]$ *
2.00...19.99 M Ω	0.01 M Ω	
20.0...199.9 M Ω	0.1 M Ω	
200...999 M Ω	1 M Ω	
1.00...2.00 G Ω	0.01 G Ω	$\pm(4\% \text{ m.v.} + 6 \text{ digits})$ $[\pm(6\% \text{ m.v.} + 6 \text{ digits})]$ *

* – for WS-03 and WS-04 leads

Test range according to IEC 61557-2 for $U_N = 1000 \text{ V}$: 1000 k Ω ...4.99 G Ω

Display range for $U_N = 1000 \text{ V}$	Resolution	Accuracy
0...1999 k Ω	1 k Ω	$\pm(3\% \text{ m.v.} + 8 \text{ digits})$
2.00...19.99 M Ω	0.01 M Ω	
20.0...199.9 M Ω	0.1 M Ω	
200...999 M Ω	1 M Ω	
1.00...4.99 G Ω	0.01 G Ω	$\pm(4\% \text{ m.v.} + 6 \text{ digits})$
5.00...9.99 G Ω	0.01 G Ω	unspecified

- Test voltage: 50 V, 100 V, 250 V, 500 V i 1000 V
- Accuracy of generated voltage (Robc [Ω] $\geq 1000 \cdot U_N$ [V]): -0% +10% from the set value
- Detection of a dangerous voltage before commencing a measurement
- Discharging the object tested

- Measurement of insulation resistance with the use of UNI-Schuko plug (WS-03, WS-04) between all three terminals (for $U_N=1000$ V is not available)
- Insulation resistance measurement for multi-wire cables (max. 5) using an optional external AutoISO-1000c adapter
- Measurement of voltage on terminals $+R_{ISO}$, $-R_{ISO}$ within the range of: 0 V...440 V
- Test current < 2 mA

11.1.9 Light measurements

Measuring ranges of LP-1 probe

Range [lx]	Resolution [lx]	Spectral uncertainty	Accuracy
0...399.9	0.1	f1<6%	$\pm(5\% \text{ m.v.} + 5 \text{ digits})$
400...3999	1		
4.00 k...19.99 k	0.01 k		

Range [fc]	Resolution [fc]	Spectral uncertainty	Accuracy
0...39.99	0.01	f1<6%	$\pm(5\% \text{ m.v.} + 5 \text{ digits})$
40.0...399.9	0.1		
400...1999	1		

- Probe class B

Measuring ranges of LP-10B probe

Range [lx]	Resolution [lx]	Spectral uncertainty	Accuracy
0...39.99	0.01	f1<6%	$\pm(5\% \text{ m.v.} + 5 \text{ digits})$
40.0...399.9	0.1		
400...3999	1		
4.00 k...39.99 k	0.01 k		
40.0 k...399.9 k	0.1 k		

Range [fc]	Resolution [fc]	Spectral uncertainty	Accuracy
0...3.999	0.001	f1<6%	$\pm(5\% \text{ m.v.} + 5 \text{ digits})$
4.00...39.99	0.01		
40.0...399.9	0.1		
400...3999	1		
4.00 k...39.99 k	0.01 k		

- Probe class B

Measuring ranges of LP-10A probe

Range [lx]	Resolution [lx]	Spectral uncertainty	Accuracy
0...3.999	0.001	f1<2%	$\pm(2\% \text{ m.v.} + 5 \text{ digits})$
4.00...39.99	0.01		
40.0...399.9	0.1		
400...3999	1		
4.00 k...39.99 k	0.01 k		
40.0 k...399.9 k	0.1 k		

Range [fc]	Resolution [fc]	Spectral uncertainty	Accuracy
0...3.999	0.001	f1<2%	±(2% m.v. + 5 digits)
4.00...39.99	0.01		
40.0...399.9	0.1		
400...3999	1		
4.00 k...39.99 k	0.01 k		

- Probe class A

11.1.10 Phase sequence

- Phase sequence indication: in the same direction (correct), opposite direction (incorrect)
- Range of network voltages U_{L-L} : 95 V...500 V (45 Hz...65 Hz)
- Display of phase-to-phase voltages

11.1.11 Motor rotation

- SEM motor voltage ranges: 1 V + 500 V AC
- Test current (per phase): <3.5 mA

11.1.12 **MPI-540-PV** Measurement of open circuit DC voltage U_{OC}

Range	Resolution	Accuracy
0.0 V...299.9 V	0.1 V	±(3% m.v. + 5 digits)
300 V...1000 V	1 V	±(3% m.v. + 2 digits)

11.1.13 **MPI-540-PV** Measurement of short circuit DC current I_{SC}

Range	Resolution	Accuracy
0.00 A...20.00 A	0.01 A	±(3% m.v. + 0,10 A)

- Before the measurement reset the clamp

11.2 Recorder data

Recorder class: compliance with EN 61000-4-30:2015 class S.

11.2.1 Inputs

Voltage input terminals

Number of inputs	5 (L1, L2, L3, N - 3 measuring channels) not galvanically insulated
Maximum input voltage	L1, L2, L3, N: 500 V _{RMS} relative to earth.
Peak input voltage (without cutting)	1150 V (L-N)
Analogue transmission band (-3 dB)	12 kHz
Transformers	defined by user
Impedance of measurement inputs	14 MΩ (L-L, L-N)
CMRR	>70 dB (50 Hz)

Current input terminals

Number of inputs	3 (L1, L2, L3) not galvanically insulated from one another
Maximum peak input voltage	5 V relative to earth
Nominal input voltage (hard clamps)	1 V _{RMS}
Peak input voltage (hard clamps, without cutting)	3.6 V
Analogue transmission band (-3dB)	12 kHz
Input Impedance	Path for hard clamps: 100 kΩ Path for flexible clamps: 12.4 kΩ
Measurement range (without transformers)	Flexible clamps F-1(A)/F-2(A)/F-3(A): 1..3000 A (10000 A peak, 50 Hz) Hard clamps C-4(A), C-5(A): 1..1000 A (3600 A peak) Hard clamps C-6(A): 0.01..10 A (36 A peak) Hard clamps C-7(A): 0..100 A (360 A peak)
Transformers	defined by user
CMRR	60 dB (50 Hz)

11.2.2 Sampling and RTC

A/C converter	16-bit
Sampling rate	5.12 kHz for 50 Hz and 60 Hz Simultaneous sampling in all channels
Samples per period	102.4 for 50 Hz; 85.33 for 60 Hz
PLL synchronization	40..70 Hz
Reference channel for PLL	L1-N, L1-L2 (depending on the type of network)
Real-time clock	±30 ppm (approx. ±2.6 s/day)

11.2.3 Voltage measurement

Voltage	Range and conditions	Resolution	Accuracy
U _{RMS} (AC+DC)	20% U _{nom} ≤ U _{RMS} ≤ 120% U _{nom} for U _{nom} ≥ 100 V	0.1% U _{nom}	±0,5% U _{nom}
Crest Factor	1..10 (1..2.2 for voltage 500 V) for U _{RMS} ≥ 10% U _{nom}	0.01	±5%

11.2.4 Measurement of current (True RMS)

Current	Range and conditions	Resolution	Accuracy
I _{RMS} (AC+DC)	Accuracy of the device		
	10% I _{nom} ≤ I _{RMS} < 100% I _{nom}	0.01% I _{n-om}	±2%
	Flexible clamps F-1A/F-2A/F-3A		
	0..3000 A (10 kA _{p-p} @ 50Hz)	0.01% I _{n-om}	Additional uncertainty ±1% (±2% taking into account additional error due to the position)
	Hard clamps C-4A		
	0..1000 A (3600 A _{p-p})	0.01% I _{n-om}	Additional uncertainty 0.1..10 A: ± (3% + 0.1 A) 10 A: ±3% 50 A: ±1.5% 200 A: ±0.75% 1000..1200 A: ±0.5%
	Hard clamps C-5A		
	0..1000 A (3600 A _{p-p})	0.01% I _{n-om}	Additional uncertainty 0.5..100 A: ≤ (1.5% + 1 A) 100..800 A: ≤ 2.5% 800..1000 A AC: ≤ 4% 1000..1400 A DC: ≤ 5%
	Hard clamps C-6A		
	0..10 A (36 A _{p-p})	0.01% I _{n-om}	Additional uncertainty 0.01..0.1 A: ± (3% + 1 mA) 0.1..1 A: ±2.5% 1..12 A: ±1%
Hard clamps C-7A			
0..100 A (360 A _{p-p})	0.01% I _{n-om}	Additional uncertainty 0..100 A: ± (0,5% + 0,02 A) (45..65 Hz) 0..100 A: ± (1,0% + 0,04 A) (40..1000 Hz)	
Crest Factor	1..10 (max. 3.6 for I _{nom}) for I _{RMS} ≥ 1% I _{nom}	0.01	±5%

11.2.5 Frequency measurement

Frequency	Range and conditions	Resolution	Accuracy
f	40..70 Hz 15% U _{nom} ≤ U _{RMS} ≤ 120% U _{nom}	0.01 Hz	±0,05 Hz

11.2.6 Measuring harmonics

Harmonics	Range and conditions	Resolution	Accuracy
Harmonic (n)	DC, 1..40, grouping: harmonics sub-groups according to EN 61000-4-7		
U _{RMS} amplitude	0..200% U _{nom}	0.01% U _{nom}	±0.15% U _{nom} if m.v.<3% U _{nom} ±(5% + 0,1% × n) m.v. if m.v.≥ 3% U _{nom}
I _{RMS} amplitude	Depending clamps used (see specifications for I _{RMS})	0.01% I _{nom}	±0.5% I _{nom} if m.v.<10% I _{nom} ±(5% + 0,1% × n) m.v. if m.v.≥ 10% I _{nom}
Voltage THD-F (n = 2..40)	0.0...100.0% for U _{RMS} ≥ 1% U _{nom}	0.1%	±5%
current THD-F (n = 2..40)	0.0...100.0% for I _{RMS} ≥ 1% I _{nom}	0.1%	±5%

11.2.7 Unbalance

Unbalance (voltage and current)	Range and conditions	Resolution	Accuracy
Unbalance factor for positive, negative and zero sequence	0.0% ... 10.0% for 80% U _{nom} ≤ U _{RMS} < 150% U _{nom}	0.1%	±0.15% (absolute error)

11.2.8 Power and energy measurement

Power and energy	Conditions (for power and energy 80% U _{nom} ≤ U _{RMS} < 120% U _{nom})	Resolution	Accuracy ⁽¹⁾
Active power Active energy	2% I _{nom} ≤ I _{RMS} < 5% I _{nom} cosφ = 1	depending on U _{nom} and I _{nom}	± √(2,5 ² + δ _{ph} ²) %
	5% I _{nom} ≤ I _{RMS} ≤ I _{nom} cosφ = 1		± √(2,0 ² + δ _{ph} ²) %
	5% I _{nom} ≤ I _{RMS} < 10% I _{nom} cosφ = 0.5		± √(2,5 ² + δ _{ph} ²) %
	10% I _{nom} ≤ I _{RMS} ≤ I _{nom} cosφ = 0.5		± √(2,0 ² + δ _{ph} ²) %
Reactive power Reactive energy	2% I _{nom} ≤ I _{RMS} < 5% I _{nom} sinφ = 1	depending on U _{nom} and I _{nom}	± √(4,0 ² + δ _{ph} ²) %
	5% I _{nom} ≤ I _{RMS} < I _{nom} sinφ = 1		± √(3,0 ² + δ _{ph} ²) %
	5% I _{nom} ≤ I _{RMS} < 10% I _{nom} sinφ = 0.5		± √(4,0 ² + δ _{ph} ²) %
	10% I _{nom} ≤ I _{RMS} < I _{nom} sinφ = 0.5		± √(3,0 ² + δ _{ph} ²) %
	10% I _{nom} ≤ I _{RMS} < I _{nom} sinφ = 0.25		± √(4,0 ² + δ _{ph} ²) %
Apparent power Apparent energy	2% I _{nom} ≤ I _{RMS} < 5% I _{nom}	depending on U _{nom} and I _{nom}	±2.5%
	5% I _{nom} ≤ I _{RMS} ≤ I _{nom}		±2.0%
Power factor (PF)	0...1 50% U _{nom} ≤ U _{RMS} < 150% U _{nom} 10% I _{nom} ≤ I _{RMS} < I _{nom}	0.01	±0.03
Displacement power factor (cosφ/ DPF)	0...1 50% U _{nom} ≤ U _{RMS} < 150% U _{nom} 10% I _{nom} ≤ I _{RMS} < I _{nom}	0.01	±0.03

(1) See section 11.2.9 Estimated measurement uncertainty values for power and energy

11.2.9 Estimated measurement uncertainty values for power and energy

The total measurement uncertainty for power, active and reactive energy (fundamental component) is based on the following relation (for energy we ignore the additional uncertainty due to time measurement, as it is much smaller than other uncertainties):

$$\delta_{P,Q} \cong \sqrt{\delta_{U_h}^2 + \delta_{I_h}^2 + \delta_{ph}^2}$$

where: $\delta_{P,Q}$ – measurement uncertainty for active or reactive power,
 δ_{U_h} – total measurement uncertainty of voltage harmonic amplitude (recorder, transducers, clamps),
 δ_{I_h} – total measurement uncertainty of current harmonic amplitude (recorder, transducers, clamps),
 δ_{ph} – additional uncertainty of error in the measurement of the phase between voltage and current harmonics.

The δ_{ph} uncertainty may be calculated when the phase angle is known for the considered frequency band. **Tab. 11.1** describes error of the phase difference between the voltage and harmonics for MPI-540 recorder (without clamps and transducers).

Tab. 11.1. Phase error of MPI-540 recorder, depending on the frequency.

Frequency range	0..200 Hz	200..500 Hz	500 Hz..1 kHz	1..2 kHz	2..2.4 kHz
Phase error	≤1°	≤2.5°	≤5°	≤10°	≤15°

Phase error introduced by transducers and clamps may be usually found in their technical documentation. In this case, we need to estimate the resultant phase error between the voltage and the current for a given frequency caused by all elements of the measuring circuit: current and voltage transducers, clamps, and the recorder.

The uncertainty of the specific harmonics active power measurements may be calculated according to the following formula:

$$\delta_{ph} = 100 \left(1 - \frac{\cos(\varphi + \Delta\varphi)}{\cos\varphi} \right) [\%], \cos\varphi \neq 0$$

On the other hand, the uncertainty of the harmonics reactive power measurement may be calculated according to the following formula:

$$\delta_{ph} = 100 \left(1 - \frac{\sin(\varphi - \Delta\varphi)}{\sin\varphi} \right) [\%], \sin\varphi \neq 0$$

In both formulas, φ means the actual phase shift angle between the current and voltage components, and $\Delta\varphi$ means the total phase error for a given frequency.

11.3 Other technical data

- a) type of insulation acc. to EN 61010-1 and IEC 61557 double
- b) measurement category acc. to EN 61010-2-030 IV 300 V, III 500 V, **MPI-540-PV** II 1000 V DC
- c) housing degree of protection for the housing acc. to EN 60529 IP51 (with closed sealing plug)
- d) meter power supply Li-Ion 11,1 V 3,4 Ah 37,7 Wh
- e) parameters of AC adapter for the battery charge 12 V DC / 2.5 A
 100 V...240 V, 50 Hz...60 Hz (mains)
- f) dimensions 288 mm x 223 mm x 75 mm
- g) weight of the meter with batteries approx. 2.5 kg
- h) storage temperature -20°C...+60°C
- i) operating temperature 0°C...+45°C
- j) temperature range suitable for initiating battery charging +10°C...+40°C
- k) temperatures at which the charging process is interrupted <+5 °C and ≥ +50°C
- l) humidity 20%...90%
- m) reference temperature +23°C ± 2°C
- n) reference humidity 40%...60%
- o) altitude (above sea level): <2000 m
- p) time until Auto-OFF 2 min, 5 min or off
- q) number of measurements Z or RCD (for batteries) >3000 (6 measurements/minute)
- r) number of measurements R_{ISO} or R (for charged batteries) >1000
- s) recording time (for batteries) 16 h
- t) display colour LCD TFT, touchscreen
 800 x 480 pixels
 diagonal 7"
- u) memory of measurement results unlimited
- v) recorder memory unlimited
- w) data transmission USB
- x) quality standard design, construction and manufacturing are ISO 9001, ISO 14001, ISO 45001 compliant
- y) the device meets the requirements of IEC 61557 standard
- z) the product meets EMC requirements (immunity for industrial environment) according to the following standards EN 61326-1 and EN 61326-2-2



EN 55022 Compliance statement

MPI-540 / MPI-540-PV is a class A product. In a domestic environment this product may cause radio interference in which case the user may be required to take adequate measures (e.g. increasing the distance between affected products).



SONEL S.A. hereby declares that the radio device type MPI-540 / MPI-540-PV complies with Directive 2014/53/EU. The full text of the EU Declaration of Conformity is available at the following website address: <https://sonel.pl/en/download/declaration-of-conformity/>

11.4 Additional data

Data on additional uncertainties are useful mainly when the meter is used in non-standard conditions and for metrological laboratories for the purpose of calibration.

11.4.1 Additional uncertainties according to IEC 61557-2 (R_{ISO})

Significant parameter	Designation	Additional uncertainty
Position	E ₁	0%
Supply voltage	E ₂	0%
Temperature 0°C...35°C	E ₃	2%

11.4.2 Additional uncertainties according to IEC 61557-3 (Z)

Significant parameter	Designation	Additional uncertainty
Position	E ₁	0%
Supply voltage	E ₂	0%
Temperature 0°C...35°C	E ₃	1.2 m lead – 0 Ω 5 m lead – 0.011 Ω 10 m lead – 0.019 Ω 20 m lead – 0.035 Ω WS-03 and WS-04 lead – 0.15 Ω
Phase angle 0°...30°	E _{6,2}	0.6%
Frequency 99%..101% f _n	E ₇	0%
Mains voltage 85%..110% U _n	E ₈	0%
Harmonic	E ₉	0%
DC component	E ₁₀	0%

11.4.3 Additional uncertainties according to IEC 61557-4 (R ±200 mA)

Significant parameter	Designation	Additional uncertainty
Position	E ₁	0%
Supply voltage	E ₂	0.5%
Temperature 0 °C...35 °C	E ₃	1.5%

11.4.4 Additional uncertainties of earth resistance measurement (R_E)

Additional uncertainties according to IEC 61557-5

Significant parameter	Designation	Additional uncertainty
Position	E ₁	0%
Supply voltage	E ₂	0%
Temperature 0 °C...35 °C	E ₃	0% for 50 V ± 2 digits for 25 V
Serial interference voltage	E ₄	±(6.5% + 5 digits)
Resistance of electrodes	E ₅	2.5%
Frequency 99%...101% f _n	E ₇	0%
Mains voltage 85%...110% U _n	E ₈	0%

Additional uncertainty caused by serial interference voltage for 3p, 4p, 3p+clamps functions

(for 25 V and 50 V)

R _E	Additional uncertainty
<10 Ω	$\pm(((-32 \cdot 10^{-5} \cdot R_E + 33 \cdot 10^{-4}) \cdot U_Z^2 + (-12 \cdot 10^{-3} \cdot R_E + 13 \cdot 10^{-3}) \cdot U_Z) \cdot 100\% + 0,026 \cdot \sqrt{U_Z \Omega})$
≥10 Ω	$\pm(((-46 \cdot 10^{-9} \cdot R_E + 1 \cdot 10^{-4}) \cdot U_Z^2 + (14 \cdot 10^{-8} \cdot R_E + 19 \cdot 10^{-5}) \cdot U_Z) \cdot 100\% + 0,26 \sqrt{U_Z \Omega})$

Additional uncertainty caused by resistance of electrodes

$$\delta_{\text{dod}} = \pm \left(\frac{R_S}{R_S + 10^6} \cdot 300 + \frac{R_H^2}{R_E \cdot R_H + 200} \cdot 3 \cdot 10^{-3} + \left(1 + \frac{1}{R_E} \right) \cdot R_H \cdot 5 \cdot 10^{-4} \right) [\%]$$

Formula is valid for $R_S > 200 \Omega$ and/or $R_H \geq 200 \Omega$.

Additional uncertainty due to interference current for 3p + clamps function

(for 25 V and 50 V)

R_E	Uncertainty [Ω]
$\leq 50 \Omega$	$\pm (4 \cdot 10^{-2} \cdot R_E^2 \cdot I_{\text{zakl}}^2)$
$> 50 \Omega$	$\pm (25 \cdot 10^{-5} \cdot R_E^2 \cdot I_{\text{zakl}}^2)$

Additional uncertainty due to interference current for double clamps function

R_E	Uncertainty [Ω]
$< 5 \Omega$	$\pm (5 \cdot 10^{-2} \cdot R_E^2 \cdot I_{\text{zakl}}^2)$
$\geq 5 \Omega$	$\pm (2,5 \cdot 10^{-2} \cdot R_E^2 \cdot I_{\text{zakl}}^2)$

Additional uncertainty for the ratio of the resistance measured with clamps on a branch of a multiple earthing, to the resultant resistance the as a function of 3p + clamps.

R_C	Uncertainty [Ω]
$\leq 99.9 \Omega$	$\pm (5 \cdot 10^{-3} \cdot \frac{R_C}{R_W^2})$
$> 99.9 \Omega$	$\pm (9 \cdot 10^{-2} \cdot \frac{R_C}{R_W^2})$

$R_C[\Omega]$ is a value of resistance measured with clamps on the branch displayed by the device, whereas $R_W[\Omega]$ is a value of resultant resistance of multiply earthing.

11.4.5 Additional uncertainties according to IEC 61557-6 (RCD)

I_A, t_A, U_B



Significant parameter	Designation	Additional uncertainty
Position	E_1	0%
Supply voltage	E_2	0%
Temperature 0°C...35°C	E_3	0%
Resistance of electrodes	E_5	0%
Mains voltage 85%...110% U_n	E_8	0%







11.5 List of reference standards

EN 61010-1:2010
 EN 61010-2-030:2010
 EN 61557-1:2007,-2, 3, 4, 5, 7:2007, -6:2007, -10:2013
 EN 60529:1991/A2:2013
 EN 61326-1:2013
 EN 61326-2-2:2013
 IEC 62752
 IEC 62955

12 Optional accessories

The full list of accessories can be found on the manufacturer's website.

		
	N-1	C-3
	WACEGN1BB	WACEGC3OKR
Rated current	1000 A AC	1000 A AC
Frequency	30 Hz...5 kHz	30 Hz...5 kHz
Max. diameter of measured conductor	52 mm	52 mm
Minimum accuracy	—	≤0.3%
Battery power	—	—
Lead length	2 m	2 m
Measurement category	III 600 V	III 600 V
Ingress protection	IP40	

							
	C-4A	C-5A	C-6A	C-7A	F-1A	F-2A	F-3A
	WACEGC4AOKR	WACEGC5AOKR	WACEGC6AOKR	WACEGC7AOKR	WACEGF1AOKR	WACEGF2AOKR	WACEGF3AOKR
Rated current	1000 A AC	1000 A AC 1400 A DC	10 A AC	100 A AC	3000 A AC		
Frequency	30 Hz...10 kHz	DC...5 kHz	40 Hz...10 kHz	40 Hz...1 kHz	40 Hz...10 kHz		
Max. diameter of measured conductor	52 mm	39 mm	20 mm	24 mm	380 mm	250 mm	140 mm
Minimum accuracy	≤0.5%	≤1.5%	≤1%	0,5%	1%		
Battery power	—	√	—	—	—		
Lead length	2.2 m	2.2 m	2.2 m	3 m	2.5 m		
Measurement category	IV 300 V	IV 300 V	IV 300 V	III 300 V	IV 600 V		
Ingress protection	IP40				IP67		

12.1.1 **MPI-540-PV** C-PV clamp

C-PV clamps are used for I_{sc} DC measurements and for DC measurements of the modules at the input of the inverter in "Inverter test" function. Clamps should be connected to the meter via **WAADACPV** adapter.

Correcting zero indication for DC current measurements

- Connect the clamps to the meter, turn on the clamps.
- Use DC ZERO knob to reset the clamps to current indication closest to zero.

Reference conditions

- a) temperature $23 \pm 5^{\circ}\text{C}$
- b) relative humidity..... 70%
- c) power supply 3 V
- d) conductor position the conductor centred in the jaws
- e) permanent magnetic field $<40 \text{ A/m}$ (Earth's magnetic field)
- f) variable, external magnetic field none
- g) external electric field: none

Technical data

- a) accuracy
 - range: **40 A DC** 0...40.0 A DC: $\pm(2.5\% + 0.1 \text{ A})$
 - range: **400 A DC** 0...400 A DC: $\pm(2.8\% + 0.5 \text{ A})$
 - range: **40 A AC** (50/60 Hz) 0...40.0 A AC: $\pm(2.5\% + 0.1 \text{ A})$
 - range: **400 A AC** (50/60 Hz) 0...400 A AC: $\pm(2.8\% + 0.5 \text{ A})$
- b) ratio
 - 40 A 10 mV/A
 - 400 A 1 mV/A
- c) output impedance 1320Ω

Other data

- a) insulation type double, according to EN 61010-1
- b) measurement category according to PN-EN 61010-1 CAT IV 300 V, CAT III 600 V, max. 1000 V DC only for isolated conductors
- c) protection class according to PN-EN 60529 IP40
- d) power supply two batteries of AAA 1.5 V type
- e) maximum diameter of tested cable $\varnothing 30 \text{ mm}$
- f) operating temperature range $0 \dots +50^{\circ}\text{C}$
- g) storage temperature $-20 \dots +70^{\circ}\text{C}$
- h) operational relative humidity $\leq 70\%$
- i) storage relative humidity $\leq 80\%$
- j) altitude (above sea level) $\leq 2000 \text{ m}$

13 Positions of the meter's cover

The movable cover enables using the meter in various positions.

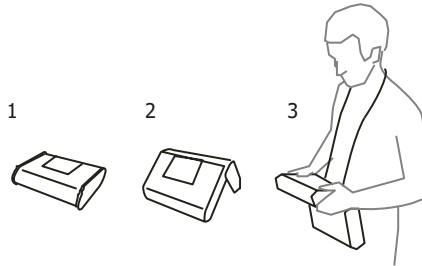

1 – Cover as the bottom of the meter

2 – Cover used as a support

3 – Cover in the position that enables convenient use of the meter suspended on the neck by means of hanging straps

14 Manufacturer

The manufacturer of the device and provider of guarantee and post-guarantee service:

SONEL S.A.

Wokulskiego 11

58-100 Świdnica

Poland

tel. +48 74 884 10 53 (Customer Service)

e-mail: customerservice@sonel.com

web page: www.sonel.com



NOTE!

Service repairs must be performed only by the manufacturer.

NOTES

NOTES

MEASURING MESSAGES



NOTE!

The meter is designed for operation at rated phase voltages of 110 V, 115 V, 127 V, 220 V, 230 V and 240 V and phase-to-phase voltages of 190 V, 200 V, 220 V, 380 V, 400 V, 415 V.

Connecting voltage higher than allowed between any of the test terminals may damage the meter and cause a hazard to the user.

Z_S measurement

L-N!

U_{L-N} voltage is incorrect for making a measurement.

L-PE!

U_{L-PE} voltage is incorrect for making a measurement.

N-PE!

U_{N-PE} voltage exceeds allowable value of 50 V.



Phase connected to N terminal instead of L terminal (for example, exchange of L and N in the mains socket).

TEMPERATURE!

Maximum temperature of the meter is exceeded.

f!

Network frequency is outside the range of 45 Hz...65 Hz.

ERROR!

Measurement error. Correct result cannot be displayed.

Loop circuit malfunction!

The meter should be serviced.

U>500V!

and continuous audio signal

Before measurement, voltage at test terminals exceeds 500 V.

VOLTAGE!

The voltage on the tested object is not within the limits specified for the set rated voltage of the network U_n.

LIMIT!

Too low value of the prospective short circuit current I_k for the pre-set fuse and time of its triggering.

R_E measurement

VOLTAGE!

Too high voltage at the meter terminals.

H!

Interruption in the test probe circuit.

S!

Interruption in the voltage probe circuit.

R_E>1.99 kΩ

Measuring range is exceeded.

NOISE!

Signal / noise ratio is too low (interfering signal too large).

LIMIT!

Measurement uncertainty R_E due to the resistance of electrodes >30 %. (For calculating uncertainty, measured values are taken into account).



Interruption in measuring circuit or resistance of test probes is higher than 60 kΩ.

RCD measurement

U_B>U_L!

The touch voltage exceeds a preset U_L threshold value.

!

displayed on the right side of the result indicates a fault of RCD.

PE!

and continuous audio signal

Voltages between the contact electrode and PE conductor exceeds the allowable limit value of U_L.

R_{ISO} measurement



and continuous audio signal

Voltage detected on terminals of the meter. Measurement is not possible.

NOISE!

Interference voltage occurs on the tested object. Measurement is possible but may be burdened with additional uncertainty.

LIMIT!

Current limit tripped. The symbol displayed during the measurement is accompanied by a continuous beep. If it is displayed after the measurement, it means that the measurement result was obtained during operation with a current limiting device (e.g. short circuit of the test object).



SONEL S.A.

Wokulskiego 11
58-100 Świdnica
Poland

Customer Service

tel. +48 74 884 10 53
e-mail: customerservice@sonel.com

www.sonel.com