

FLUKE®

ii905/ii915

Acoustic Imager

Users Manual

June 2024

© 2024 Fluke Corporation. All rights reserved.

All product names are trademarks of their respective companies.

LIMITED WARRANTY AND LIMITATION OF LIABILITY

Each Fluke product is warranted to be free from defects in material and workmanship under normal use and service. The warranty period is two years and begins on the date of shipment. Parts, product repairs, and services are warranted for 90 days. This warranty extends only to the original buyer or end-user customer of a Fluke authorized reseller, and does not apply to fuses, disposable batteries, or to any product which, in Fluke's opinion, has been misused, altered, neglected, contaminated, or damaged by accident or abnormal conditions of operation or handling. Fluke warrants that software will operate substantially in accordance with its functional specifications for 90 days and that it has been properly recorded on non-defective media. Fluke does not warrant that software will be error free or operate without interruption.

Fluke authorized resellers shall extend this warranty on new and unused products to end-user customers only but have no authority to extend a greater or different warranty on behalf of Fluke. Warranty support is available only if product is purchased through a Fluke authorized sales outlet or Buyer has paid the applicable international price. Fluke reserves the right to invoice Buyer for importation costs of repair/replacement parts when product purchased in one country is submitted for repair in another country.

Fluke's warranty obligation is limited, at Fluke's option, to refund of the purchase price, free of charge repair, or replacement of a defective product which is returned to a Fluke authorized service center within the warranty period.

To obtain warranty service, contact your nearest Fluke authorized service center to obtain return authorization information, then send the product to that service center, with a description of the difficulty, postage and insurance prepaid (FOB Destination). Fluke assumes no risk for damage in transit. Following warranty repair, the product will be returned to Buyer, transportation prepaid (FOB Destination). If Fluke determines that failure was caused by neglect, misuse, contamination, alteration, accident, or abnormal condition of operation or handling, including overvoltage failures caused by use outside the product's specified rating, or normal wear and tear of mechanical components, Fluke will provide an estimate of repair costs and obtain authorization before commencing the work. Following repair, the product will be returned to the Buyer transportation prepaid and the Buyer will be billed for the repair and return transportation charges (FOB Shipping Point).

THIS WARRANTY IS BUYER'S SOLE AND EXCLUSIVE REMEDY AND IS IN LIEU OF ALL OTHER WARRANTIES, EXPRESS OR IMPLIED, INCLUDING BUT NOT LIMITED TO ANY IMPLIED WARRANTY OF MERCHANTABILITY OR FITNESS FOR A PARTICULAR PURPOSE. FLUKE SHALL NOT BE LIABLE FOR ANY SPECIAL, INDIRECT, INCIDENTAL OR CONSEQUENTIAL DAMAGES OR LOSSES, INCLUDING LOSS OF DATA, ARISING FROM ANY CAUSE OR THEORY.

Since some countries or states do not allow limitation of the term of an implied warranty, or exclusion or limitation of incidental or consequential damages, the limitations and exclusions of this warranty may not apply to every buyer. If any provision of this Warranty is held invalid or unenforceable by a court or other decision-maker of competent jurisdiction, such holding will not affect the validity or enforceability of any other provision.

Fluke Corporation
6920 Seaway Blvd.
Everett, WA 98203
U.S.A.

Fluke Europe B.V.
PO Box 1186
5602 BD Eindhoven
The Netherlands

11/99

THIS PRODUCT IS LICENSED UNDER THE AVC PATENT PORTFOLIO LICENSE FOR THE PERSONAL USE OF A CONSUMER OR OTHER USES IN WHICH IT DOES NOT RECEIVE REMUNERATION TO (i) ENCODE VIDEO IN COMPLIANCE WITH THE AVC STANDARD ("AVC VIDEO") AND/OR (ii) DECODE AVC VIDEO THAT WAS ENCODED BY A CONSUMER ENGAGED IN A PERSONAL ACTIVITY AND/OR WAS OBTAINED FROM A VIDEO PROVIDER LICENSED TO PROVIDE AVC VIDEO. NO LICENSE IS GRANTED OR SHALL BE IMPLIED FOR ANY OTHER USE. ADDITIONAL INFORMATION MAY BE OBTAINED FROM MPEG LA, L.L.C. SEE [HTTP://WWW.MPEGLA.COM](http://www.mpegla.com).

Table of Contents

Title	Page
Introduction.....	1
Contact Fluke	1
Safety Information	1
Specifications	1
Before You Start	2
Terms to Know.....	3
Power On/Off.....	4
Power and Charging Indication	4
Battery	4
Features/Buttons	6
Hand Strap/Neck Strap.....	7
Display.....	7
Menus.....	8
Capture Mode.....	8
Image	8
Video	8
Capture Analysis Modes.....	9
LeakQ™ Mode	9
PDQ Mode™ (ii915).....	10
MecQ™ Mode (ii915)	10
Memory	11
Annotations	11
Text Note	11
Photo Note	12
Tag Note.....	12

Acoustics	13
Show PD Count: On or Off (ii915)	13
Show dB Scale: On or Off	13
Min / Max dB	13
High Frequency (ii915)	13
Single Source/Multiple Sources	14
Profiles	14
MecQ Mode (ii915)	14
Palette	14
Markers	14
Settings	15
File Format	15
Date & Time	15
Display	15
Localization	15
Factory Settings	15
Operating Conditions	15
Imager Info	15
Test Microphones	15
Save Diagnostic Information	15
Basic Operation	16
File Transfer	17
Import Saved Images or Video Files with Fluke Connect Desktop	17
Import Saved Images or Video Files using Wi-Fi and Fluke Connect Cloud	18
Sign in to Fluke Connect Wi-Fi Network	18
Sign in to Fluke Connect Cloud	18
Uploading images	18
Firmware Update	19
Maintenance	19
How to Clean the Case	19
Acoustic Sensor Care	19
Environmental	20
Product Disposal	20
Service	20
Fluke Premium Care	20

Introduction

The Fluke ii905/ii915 is an Acoustic Imager (the Product or Imager) that detects and locates an acoustic signature. These signatures can indicate leaks in compressed air, compressed gas, and vacuum systems.

In addition to leaks, the ii915 detects electrical discharges and potential mechanical issues.

Examples of these electrical discharges include partial discharge such as corona, surface tracking, and arcing. Examples of mechanical issues include bearing deterioration.

The Imager has an acoustic sensor-array that aligns a sound-source heatmap with the image. The visible-light camera provides a live-view image of the inspection area. Capture and save still image files and video files from the inspection for documentation and reports.

A rechargeable battery powers the Imager. The Imager includes a USB-C Charger with detachable country specific plugs.

The Imager has a USB-C port that connects to a PC for file download and firmware updates.

Contact Fluke

Fluke Corporation operates worldwide. For local contact information, go to our website: www.fluke.com.

To register your product, view, print, or download the latest manual or manual supplement, go to our website.

+1-425-446-5500

fluke-info@fluke.com

Safety Information

General Safety Information is in the printed Safety Information document that ships with the Product and at www.fluke.com. More specific safety information is listed where applicable.

A **Warning** identifies hazardous conditions and procedures that are dangerous to the user. A **Caution** identifies conditions and procedures that can cause damage to the Product or the equipment under test.

Specifications

Complete specifications are at www.fluke.com. See the ii905/ii915 Product Specifications.

Before You Start

Table 1 is a list of items included with the Imager. Use the part numbers to order additional accessories.

Table 1. Standard Equipment

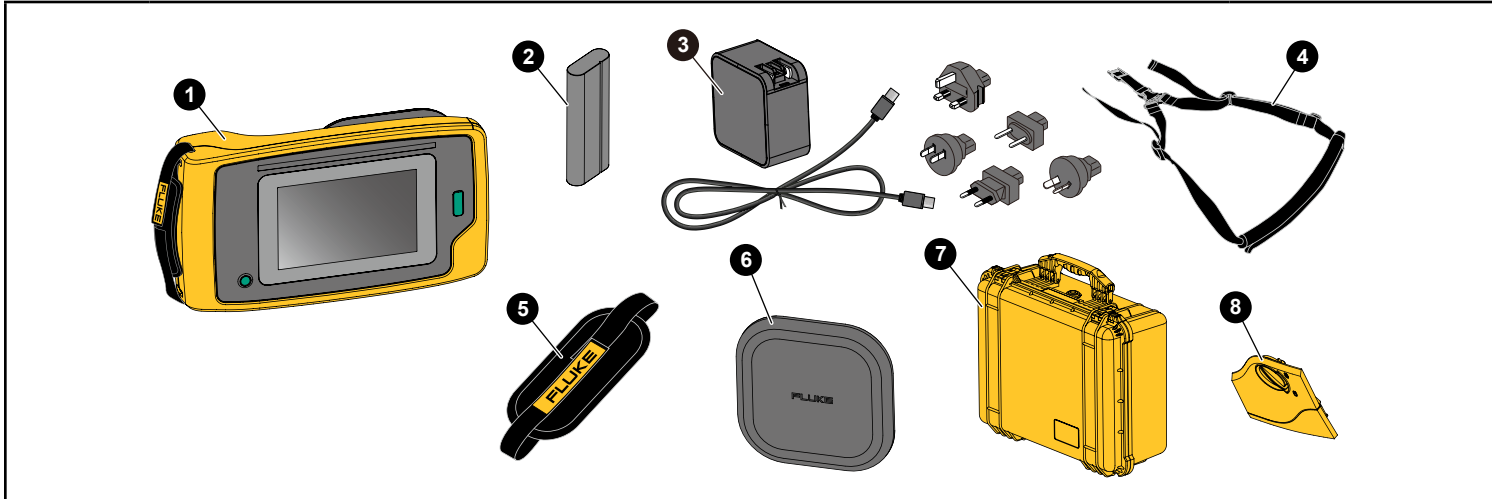

Item	Description	Part Number
1	ii9X5 Acoustic Imager	N/A
2	Rechargeable Lithium-ion Battery Pack	3894688
3	USB-C Charger with country specific connectors and USB-C Cable.	6013614
4	Neck Strap	4574715
5	Hand Strap	5075994
6	Acoustic Sensor Cover	5075982
7	Protective/Carry Case	4628917
8	Battery door	5104173

Terms to Know

Use this section to familiarize yourself with these terms that are unique to this Imager and sound pressure measurements.

Decibel (dB) Sound Pressure Level (SPL). The unit of measurement for changes in sound pressure. Decibel indicates the level of the sound (against the reference level of sound in air) and is expressed in terms of dB SPL.

Distance to target. The distance between the leak source and the acoustic sensor is critical. The decibel level that the Imager can measure decreases with the square of this distance.

Sound Frequency / Acoustic Frequency / Frequency Band. The frequency corresponds to the number of sound vibrations/second and is expressed as Hertz (Hz) or thousands of Hertz (kHz).

Frequency Range

Audible (up to 20 kHz). The range that human ear can perceive sounds.

Ultrasonic (above 20 kHz). Certain issues (leaks, electrical discharges, mechanical failures) generate sound signatures in ultrasonic ranges. The human ear cannot perceive the ultrasonic range that the Imager can detect.

Frequency Selection / Frequency Filtering / Selected Frequency Band. Select a frequency band for measurement and visualization of sound. When a frequency band is selected, any sound outside of that range is filtered and not shown or considered.

Background Noise. The noise that exists in the surroundings that the microphone sensors detect along with the sound sources of possible leaks. Generally, background noise is higher in lower frequencies. In noisy environments, select higher frequencies to help discriminate the leak sounds.

Frequency / Spectrum Graph. A graphic chart on the display shows the level of sound detected in all frequency ranges.

Frequency Spike. Spike in the frequency / spectrum graph that indicates a significant source of sound in this specific frequency. If this spike is within the frequency selection, the Imager visualizes the source on the display.

Field-of-View (FOV). What is detected by the Imager at a particular position and orientation in space.

Sound Reflections. Sound signals reflect, particularly on smooth and flat surfaces. In certain conditions, the Imager shows on the display a hot spot from the source of noise and one or more hot spots from reflections.

LeakQ™. LeakQ is a capture mode that estimates the size of a leak. LeakQ Scale is a scale from 0 to 10 that is an indication of the leak size. The Imager calculates a value based on the measured dB SPL level and the distance value. The distance value is automatically determined or you input a value with the display keyboard.

PDQ Mode™. PDQ Mode is a capture mode that detects and locates potential partial discharges. The PDQ Mode indicates a possible type of Partial Discharge (External, Internal, Tracking, or Other), Pulse count indication/minute, and Phase-resolved Partial Discharge Plot (PRPD plot).

Partial Discharge (PD). PD is a localized dielectric breakdown that does not completely bridge the electrical insulation between two conductors under high voltage.

PD types are classified into three main types:

- External discharge, or corona discharge, is the ionization of a fluid, gas, or air surrounding a conductor that is electrically charged at high voltage.
- Internal discharge occurs in voids or cavities within solid or liquid dielectrics.
- Surface discharge tracks across the surface of different insulation materials.

MecQ™. MecQ is a capture mode that detects and locates potential anomalies in mechanical components as an early identification of possible mechanical deterioration that requires further inspection.

Power On/Off

To turn on the Imager, push and hold  >2 s.

To turn off the Imager, push . Tap **OK** to continue.

Power and Charging Indication

- The power button flashes to show the Imager is starting.
- The power button identifies the state of the battery: red is low power, amber is charging, and green is fully charged.

Battery

Warning

To prevent personal injury and for safe operation of the Product:

- **Do not put battery cells and battery packs near heat or fire.**
- **Do not put in sunlight.**
- **Do not disassemble or crush battery cells and battery packs.**
- **Remove batteries to prevent battery leakage and damage to the Product if it is not used for an extended period.**
- **Connect the battery charger to the mains power outlet before the Product.**
- **Use only Fluke approved power adapters to charge the battery.**
- **Keep cells and battery packs clean and dry. Clean dirty connectors with a dry, clean cloth.**

Caution

To prevent damage to the battery:

- **Do not expose battery to heat sources or high-temperature environments such as an unattended vehicle in the sun.**
- **Do not store the battery on the charger for more than 24 hours as reduced battery life may result.**
- **Charge the battery for a two-hour minimum at six-month intervals for maximum battery life. Without use, the battery will self-discharge in approximately six months.**
- **Always operate in the specified temperature range.**
- **Do not incinerate the Product and/or battery.**

The battery is tested in accordance with and complies to:

- UN Manual of Tests and Criteria Part III Subsection 38.3 (ST/SG/AC.10/11/Rev.5) – also known as the UN T19.T8 tests
- REACH
- UL2054
- IEC 62133
- ROHS

The battery has an indicator with four LEDs (25 %, 50 %, 75 %, and 100 % charge) and a test button. To check the battery charge, push . The LEDs light to show the battery charge level. If all four LEDs are on, the battery charge is at 100 % of available capacity.

To install the battery:

1. Open the battery door. See [Figure 1](#).
2. Insert the battery with the contact side first.
3. Replace the battery door. Make sure that the battery tab does not interfere with the lock and the door is firmly closed.

To charge the battery:

Connect the USB-C Charger to the ac wall outlet and connect the USB-C cable to the USB-C charging connector next to the battery compartment.

Figure 1. Battery

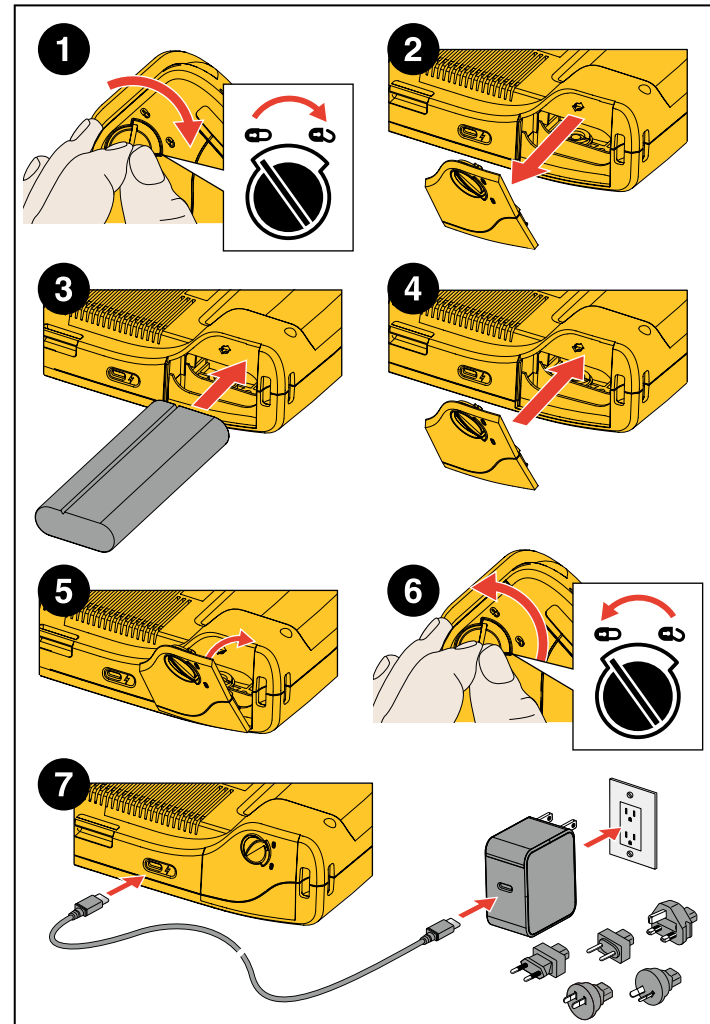

Features/Buttons

Table 2 is a list of the Imager features.

Table 2. Feature/Control Descriptions

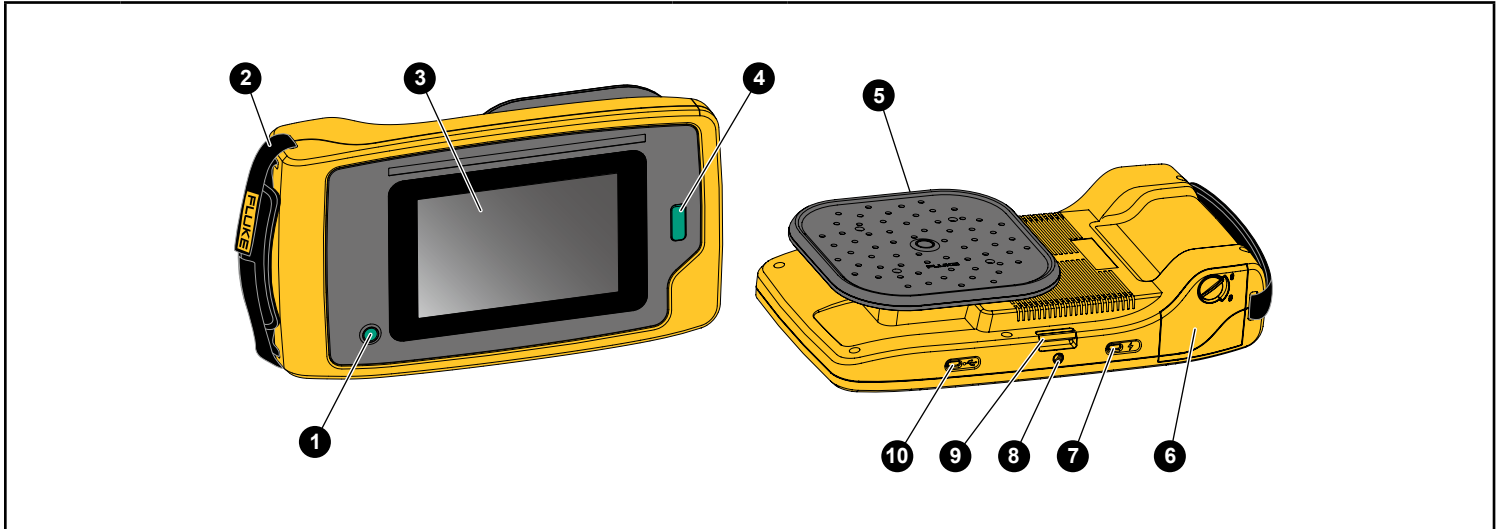

Button	Function	Button	Function
1	Power On/Off	6	Battery Compartment
2	Hand Strap	7	USB-C Connector for charging.
3	Touchscreen Display	8	Tripod Connection
4	Capture Button for Image or Start/Stop Video	9	Neck Strap Anchor
5	Acoustic Sensor	10	USB-C Connector for data communication

Hand Strap/Neck Strap

The Imager includes a hand strap and a neck strap that makes it easy to hold and operate as you take measurements. See [Figure 2](#) for information about setup.

Figure 2. Hand Strap/Neck Strap



Display

The color display is a touchscreen that shows the test area as a visual image combined with a sound image. See [Table 3](#).

With the touchscreen you are able to set up and adjust all the test parameters. For more information, see [Basic Operation](#).

Table 3. Touchscreen

Item	Description
1	Tool Menu
2	Zoom
3	Capture Mode
4	Frequency Range of Spectrum
5	Palette of dB SPL Scale
6	Profile Selection (when enabled)
7	Folder Selection
8	Time/Date Stamp
9	Battery Status

Menus

To view the tool menu, tap your finger on the display. This action reveals the menu for parameter settings. Tap anywhere on the display outside the menu to hide the menu.

Capture Mode

When you push the **Capture** button, you save an image of the scene in the selected mode.

To select the capture mode:

1. Open the tool menu.
2. Tap the Capture Mode icon to open the Capture Mode menu.
3. Tap on the option to select.
The icon on the tool menu and the display change to show the selected mode.
4. Tap anywhere on the display outside the tool menu to hide the menu.

Image

Image mode captures a still photo of the scene with overlapping sound image and saves it in a .PNG or .JPG format. The Image mode is the best method for the initial scan of the scene for any type of issue. If an issue is detected, then you have options for advanced analysis modes. See [Capture Analysis Modes](#).

1. Push the **Capture** button to save the still photo
After the image is saved, a small image (thumbnail) shows on the screen.
2. Tap  to add notes, photo notes, or tags to the image. See [Memory](#) for more information.

Video

Video mode captures a video of the scene with overlapping sound image and saves it in an .MP4 format.

1. Push the **Capture** button to start recording.
The elapsed time shows as the Imager records.
2. Push the **Capture** button again to stop recording and save the video.
After the video is saved, a small image (thumbnail) shows on the screen.
3. Tap  to add notes, photo notes, or tags to the image. See [Memory](#) for more information.

Capture Analysis Modes

LeakQ™ mode. The Imager is able to capture the leak data for later use to evaluate the type of leak (quick connect, threaded coupling, hose, open end) and estimate the size of the leak.



PDQ Mode™ (ii915). The Imager is able to detect, locate, and capture potential partial discharges and evaluate the type of partial discharge (external, internal, surface, or other). The data includes information for later use to create pulse phase diagrams.

MecQ™ mode (ii915). The Imager is able to detect, locate, and capture a picture of components that may have mechanical deterioration and require further attention.

To select the capture analysis mode:

1. Open the tool menu.
2. Tap the Capture Mode icon to open the Capture Mode menu.
3. Tap  for the LeakQ mode.
The icon on the tool menu and the display change to show the selected mode.

ii915:

4. Tap  for the PDQ Mode.
5. Tap  for the MecQ mode.

Online tools and calculators are available to create reports with (data) captures that use the LeakQ, PDQ, and MecQ modes. For more information, go to: www.fluke.com/ii-reporting.

The capture analysis modes show on the display when the on-device option is turned on. When on, a portion of the analysis shows on-screen at the time of capture (see [Settings](#) and [Operating Conditions](#)).

LeakQ™ Mode

LeakQ mode estimates the LeakQ value (1-10), leak rate (l/min or CFM) and leak cost (per year) for leaks shown inside the circle on the display.

The values are based on the measured dB SPL value, operating conditions (settings menu) and the distance.

If a leak shows inside the circle on the display:

- Values for **DISTANCE** and **LeakQ Scale** show on the display.

or

- **NO TARGET FOUND** shows on the display when no leak is detected inside the circle.

If the Imager cannot automatically determine the distance, this message shows on the display:

UNABLE TO ESTIMATE DISTANCE

If the Imager is unable to determine the distance, or you want to override the estimated distance, you can input the distance manually.

To input the distance manually:

1. Tap on the message to open a numeric screen and enter the distance.
The Imager uses the entered distance to calculate the LeakQ values.

Note

Stabilize the Imager for a few moments as it calculates the values.

2. Push the **Capture** button to make a more precise calculation.
3. If the measured distance requires additional adjustment, tap the Distance box to update.

4. Push **Capture** button or **Save** in the menu.
The Imager saves the still photo of the scene with overlapping sound image and values in .PNG or .JPG format. You can add notes, photo notes, or tags to the image. See [Memory](#) for more information.

Note

For best results:

- *Move the Imager around the leak to find the highest LeakQ value. This will best reflect the actual leak size.*
- *Obstacles within the circle can influence the calculated distance and LeakQ value.*
- *High background noise will influence the calculated distance and LeakQ value.*

 **PDQ Mode™ (ii915)**

PDQ Mode™ captures data from a Partial Discharge (PD) that enables further analysis such as type of discharge and severity. The PD must be inside the circle on the display.

When a PD is detected, the PD Count value on the display gives an indication of the pulses generated by that partial discharge.

The value is based on the pulses of the acoustic interference generated by the PD:

- Values for estimated DISTANCE show on the display.

or

- **NO TARGET FOUND** shows on the display when no PD is detected inside the circle.

If the Imager cannot automatically determine the distance, this pop-up message shows on the display:

UNABLE TO ESTIMATE DISTANCE

If the Imager is unable to determine the distance, or you want to override the estimated distance, you can input the distance manually. See [LeakQ™ Mode](#).

Note

See LeakQ Mode for instructions on capture. (not related to PD Count)

The Imager saves the still photo of the scene with overlapping sound image and values in .PNG or .JPG format. You can add notes, photo notes, or tags to the image. See [Memory](#) for more information.

 **MecQ™ Mode (ii915)**

MecQ™ mode detects and locates potential anomalies in mechanical components as an early identification of possible mechanical deterioration that requires further inspection.

See LeakQ™ Mode for instructions on capture and save.

Memory

The Memory menu shows an overview of all saved files with a thumbnail image. Each thumbnail includes an icon to indicate the file type:



Image



Video



LeakQ



PDQ Mode



MecQ

To view a file, tap on the thumbnail once to open the file on the display.

To delete a single image file:

1. Tap on the image once to open the file on the display.
2. Tap  to delete the file.

To delete multiple image files:

1. Tap and hold an image file.
The mode changes to multi-file selection.
2. Tap all files to delete.
3. Tap  (see top right of the display) to delete multiple files.

An icon also identifies the annotation type. When the file includes an annotation, the icon changes to include a yellow dot.

Annotations

You have 2 methods to access the annotation menu:

- After a capture (image or video), tap on the small thumbnail that shows on the bottom left corner
- Tap on any capture (image or video) to go to the Memory Menu

The annotation menu on the left side of the screen shows the types of notes. Each note is identified with an icon. These icons include a yellow dot when annotation data is available.



Text Note

You can add additional information to files with Text Note.

To add a text note:

1. Tap on the image thumbnail to open the file on the display.
2. Tap  to edit a note.
3. Tap **X** or the Close Keyboard icon.

To Delete a text note:



1. Tap on the image file to open the file on the display.
2. Tap  to edit a note.
3. Tap  to delete the note.



Photo Note

A Photo Note is an additional photo attached to the file. Examples include a photo of a label or location that adds additional information about the file.

To add a Photo Note:

1. Tap on the image file to open the file on the display.
2. Tap  to open the Photo Notes menu.
3. Tap **+** to open the Camera view.
4. Push the **Capture** button to take the photo.
The Imager adds the photo as a note.
5. Tap **<** to close the Photo Notes menu.

To delete a Photo Note:

1. Tap on the image file to open the file on the display.
2. Tap  to open the Photo Notes menu.
3. Tap on the Photo Note icon you want to delete.
4. Tap  to delete the Photo Note.

Tag Note

A Tag Note is a set of predefined fields attached to a file. These fields store data about the file that is useful for comparison and evaluation.

To add a Tag Note:

1. Tap on the image thumbnail to open the file on the display.
2. Tap  to open the Tag Note menu.
3. Tap on the tag category you want to add:
 - a. General
 - Asset name: Open text field
 - Asset ID: Open text field or enter with QR Code scan (see step 4).
 - Asset Type: Pre-defined list of asset types.
 - Inspection Status: As found; As left (Default: Undetermined).
 - Action required: Yes, No (Default: Undetermined).
 - Priority: High; Medium, Low (Default: Undetermined).
 - Action Notes: Open text field
 - b. Leaks
 - Type of Leak: Based on outcome of on-device analysis. Option for end-user to modify.
 - Type of Gas: Pre-defined list of gas types.
 - Pressure of Line/Pressure unit system: Open numeric entry.

Note

Only the Type of Leak category affects the leak rate estimation. Gas and Pressure are for documentation purposes only.



c. Electrical

- Discharge Type: pre-defined partial discharge type by on-device data analysis and highest likelihood. Option for end-user to modify.
- Voltage / Frequency: Open numeric entry.
- Ambient Temp: Open numeric entry.
- Relative Humidity (%): Open numeric entry.
- Weather Notes: Open text field.

d. Mechanical (ii915)

- Component Type: Pre-defined list of mechanical components.
- Speed (RPM): Open numeric entry.
- Severity: High, Medium, Low (Default: Undetermined).

For QR code-based Asset ID recognition:

4. Tap  to use the camera to capture and read QR code.
Inspection Status: Asset Inspection Status helps you to select and assign the status of inspection:
 - Action required: Yes, No (Default: Undetermined).
 - Action priority: High, Medium, Low (Default: Undetermined).
 - Action notes: Open text field.
5. Tap  to close the Tag Note menu.

Acoustics

The Acoustics menu shows all the available settings for adjustment.

Show PD Count: On or Off

The PD Count (Partial discharge pulse count) value is an indication of the number of pulses/minute that the Imager detects.

Show dB Scale: On or Off

You can choose to show or hide the dB scale. Turn off the dB scale to see a larger visual area on the display.

Min / Max dB

The minimum/maximum decibel (dB) settings determine the sound level (intensity) that shows on the SoundMap™. Decibel level thresholds help you to visualize leaks in challenging conditions, for example, very small leaks or a lot of background noise in the same frequency range as a leak. For more information, see [Profiles](#).

Auto: Automatically adjusts the Color Palette Scale to the minimum/maximum decibel value for the received sound pressure.

Manual: The Color Palette Scale is a user-defined minimum/maximum decibel value. Levels above the maximum value show on the display with the same color as the maximum value. Levels below the minimum value do not show on the display.

When Manual is selected, use the +/- to adjust. Or, tap on the dB SPL scale and use the slider to manually adjust the minimum and maximum in decibel values of the Color Palette Scale.

High Frequency (ii915)

Toggle between the standard frequency range up to 52 kHz and the expanded frequency range up to 100 kHz.

Single Source/Multiple Sources

The **Single Source** mode shows less noise and reflection on the display. Smaller leaks or partial discharges do not show when they are close together with larger leaks or PD in the same field of view.

The **Multiple Sources** mode will not mask smaller leaks or partial discharges when they are in presence of larger leaks or PD. When in Multiple Sources mode, several markers show on the display to indicate the peak dB level of any detected source of sound.

Note

The central marker does not show on the display in the Multiple Sources mode. The Multiple Sources mode is not available in MecQ mode.

Profiles

Profiles allow you to reuse the manual settings such as Frequency band, Max dB scale and Min dB scale, and Palette.

On: A preset profile is active. The icon in the center bottom of the display allows you to select a profile or save the current settings as a profile.

Off: Turn off the preset profile.

Note

When you turn on and turn off the Imager, the settings for Frequency Band, Max dB, Min dB, and Palette reset to the values in the selected profile, not the current settings when the unit is turned off. If no profile is selected when the Imager is turned off, the Imager uses the factory-default profile.

MecQ Mode (ii915)

MecQ offers four modes to identify potential mechanical areas of interest:

Mode 1: Auto mode. In this mode you can select a 20 kHz frequency band and a 2 kHz band with the highest sound intensity will automatically be used for analysis.

Mode 2: 30 kHz mode (default). This mode automatically activates the 30 kHz frequency band.

Mode 3: User selection mode. In this mode you can select any frequency range between 2 kHz and 100 kHz

Mode 4: Fixed Multi mode. This mode automatically activates five predefined frequency bands.

Palette

Select the palette for the acoustic image. The color palettes offer an equal, linear presentation of colors for the best presentation of data detail. Or you can switch the live visual camera to greyscale mode.

Markers

When the Centerpoint Marker is On, the dB level of the Centerpoint shows on the display as value on the center of the display.

Note

The display shows the dB value of the selected frequencies as received in the center of the Field-of-View. This is not the dB value of the sound source.

Settings

The Settings menu shows all the available settings for adjustment.

File Format

- set image format (JPG or PNG)
- set video format (MP4 format)

Date & Time

- set date and format
- set time and format

Display

- turn on or turn off the display logo

Localization

- select language
- set decimal separator to point or comma
- set units of measurement

Factory Settings

- startup Profile, see [Profiles](#)
- reset to Factory Defaults
- clear User Data (clear all images, videos, and other user data)

Operating Conditions

- Set LeakQ Operating Conditions
 1. Input the data relevant to your system and operating conditions.
 2. Select the LeakQ metrics (rate/costs or LeakQ scale) to display.

More information: www.fluke.com/leakq

- Set PDQ Mode network operating frequency (ii915)
 1. Select your network operating Frequency.
 2. Select the PDQ indicators to display: Discharge Type, PD Count, Real time PRPD Plot.

More information: www.fluke.com/pdq

Note

The PRPD plot is only generated if 50 Hz or 60 Hz is selected.

Imager Info

- firmware version
- hardware version
- device registration

Use a mobile phone to scan the QR code and register your device to receive important product updates. The serial number and model number are automatically found during the registration process.

Test Microphones

- verify the correct operation of the microphones

Save Diagnostic Information

- use at request of Fluke Customer Service to save diagnostic information

Note

The diagnostic info file is saved in the Imager memory at /User Data/DiagnosticInfo/.

Basic Operation

The Imager works much like a point-and-shoot camera.

⚠ Caution

Do not place hand on or obstruct the acoustic sensor. Always use the sensor cover when the Product is not in use.

1. Remove the sensor cover before use.
2. Push and hold  >2 s.
3. Aim the Imager at the test area.
Ideal distance is 1 m to 8 m (3 ft to 26 ft).
With good line-of-sight, >8 m to ≤21 m (>26 ft to ≤70 ft).
4. Select a band on the frequency spectrum on the right side of the display. See [Table 4](#).
5. Change the width of the band by sliding the edges or move by sliding the middle of the band.
6. The optimum band depends on the environment and application. As an example for finding air or gas leaks, start with a band at 35 kHz and width that spans 5 kHz.

Note

High frequency peaks within the selected band may be caused by sources other than a leak or partial discharge. In this case, move the band to another frequency range.

If a strong source of sound is off the field-of-view, the display shows a circular pattern (flower) of hot spots on the SoundMap™. In this case, scan around for the source of sound.

Table 4. Frequency Band Adjustment

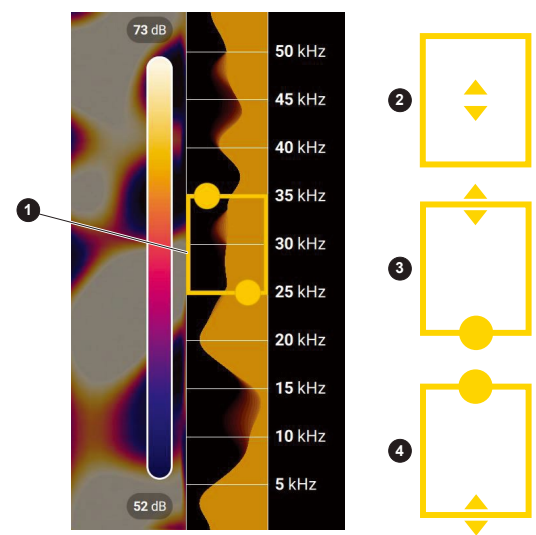

Item	Description
1	Frequency Band
2	Move within the Spectrum: Touch center of box until arrows show. Slide the box up and down to move the frequency range.
3	Adjust high end: Touch upper edge of box until arrows show. Slide edge up to change high end of the frequency range.
4	Adjust low end: Touch lower edge of box until arrows show. Slide edge down to change low end of the frequency range.

Maximum Frequency Range:
 ii90565 kHz
 ii915100 kHz

7. When the area of interest clearly shows, push the **Capture** button. The Imager saves the image to memory.

Tip: Sound signals reflect, particularly on smooth and flat surfaces. In certain conditions, the Imager shows a steady spot on the source of noise and one or more steady spots from the reflections. Move the Imager around to help discriminate the sound source from the reflections. The sound source remains in the same location, while reflections will move.

Use folders to organize your files. New file captures save to the folder name that shows on the display. You have the option to review files by folder name or timestamp.

To select a folder or create a new folder name:

1. Tap on the folder name that shows at the bottom of the display. A list of folder names pops up with the option, **Create Folder**.
2. When you select **Create Folder**, use the keyboard to input a new file name.

For more information about how to view the images in memory, see [Memory](#).

File Transfer

To transfer saved files from the Imager to a PC:

1. Use the provided USB cable to connect the Imager to the PC. A USB drive is added to the list of drives on your PC.
2. Open the added USB drive to view the saved images or video files.
3. Copy the files you want to the local PC drive.
4. When transfer is complete, remove the USB drive from your PC.

The Fluke Connect Desktop application is another method you can use to download images or video files. See [Import Saved Images or Video Files with Fluke Connect Desktop](#).

Import Saved Images or Video Files with Fluke Connect Desktop

Fluke Connect Desktop is an application installed on a local PC.

To import saved images or video files:

1. Start the Fluke Connect Desktop application on your PC.
2. Turn off the Imager.
3. Connect the Imager to the PC with a USB/USB-C cable.
4. Turn on the Imager.
5. Open Fluke Connect Desktop on the PC. The Fluke ii9XX-Series shows in the **TOOLS** tab.
6. Select **DOWNLOAD**.
7. Use **DOWNLOAD ALL** or **SELECT FILES** to transfer all or a selection of files to Fluke Connect Desktop.
8. Select the destination folder and select **OK**.
9. Confirm deletion of downloaded files from the Imager or select **CANCEL** to proceed and keep the files in the Imager. Downloaded files are now available in the **MEASUREMENTS** tab.

Import Saved Images or Video Files using Wi-Fi and Fluke Connect Cloud

When the Product is connected to a Wi-Fi network, you can sign into your Fluke Connect account on the Imager and use Fluke Connect Instant Upload. When you use Fluke Connect Instant Upload, the images you take with the Product can be uploaded to your Fluke Connect account in the Fluke Cloud. The images saved in the Fluke Cloud are automatically synced with the Fluke Connect Desktop program and can be viewed there.

Note

The Instant Upload feature may not work on all networks or with all devices due to the security profiles on different networks.

Sign in to Fluke Connect Wi-Fi Network

Use the Wi-Fi Network setting to connect the Product to a Wi-Fi network and to sign into a Fluke Connect account on the Product. To turn on the Wi-Fi Network feature:

1. Select **Settings > Wi-Fi Settings > Wi-Fi > On**.
2. Select **Network** to scan for available networks within range of the Product.
3. Tap on a network to connect to it.
4. Use the keyboard to enter a password.
5. Tap **Sign In**.
The display returns to the Wi-Fi settings menu.

Sign in to Fluke Connect Cloud

To sign in to your Fluke Connect account:

1. Select **Fluke Connect**.
2. Use the keyboard to enter an email address as user and a password.
3. Tap **Sign In**.
The display returns to the Wi-Fi settings menu.

Uploading images

To automatically send captured images directly to the cloud select **Instant Upload**.

Alternatively turn **Instant Upload** Off and select the image to transfer by selecting Memory in the main menu and then select **Transfer** from the Memory menu.

When **Delete on imager after upload** is turned on, the images are deleted from the imager after uploading.

Firmware Update

Firmware updates are available for the Imager. Connect the Imager to Fluke Connect Desktop or go to www.fluke.com to find the most current firmware version.

To update with Fluke Connect Desktop:

1. Use the provided USB cable to connect the Imager to a PC with the current version of Fluke Connect Desktop software installed. Fluke Connect Desktop software detects the connected Imager, checks the firmware version, and updates the Imager if a newer firmware version is available. Fluke Connect Desktop requires an Internet connection to download a new firmware version. The Imager shows a message to confirm the update.
2. Tap **YES** to confirm and start the firmware update. The Imager shows a message to restart the Imager.
3. Tap **YES** to restart the Imager.

To update with a .swu file:

1. Download the firmware update (.swu file) from the Fluke website to a PC.
2. Use the provided USB cable to connect the Imager to the PC with the new firmware update file. A USB drive is added to the list of drives on your PC.
3. Copy the firmware update file (.swu) from the PC to the root folder (/User Data/) of the added USB drive.
4. When the file copy is complete, safely remove the USB cable from your PC. The Imager shows a message to inform you that a firmware update is found.
5. Tap **YES** to confirm and start the firmware update. The Imager shows a message to restart the Imager.
6. Tap **YES** to restart the Imager.

Maintenance

The Imager does not require routine maintenance.

Caution

The optical surfaces of the lens are equipped with high-quality optical layers. Avoid any contact with these surfaces and protect these surfaces against dirt and damage.

How to Clean the Case

Clean the case with a clean, damp cloth. Do not use abrasives, isopropyl alcohol, or solvents to clean the case or lens/window.

Acoustic Sensor Care

Caution

The Imager has highly-sensitive acoustic sensors. Do not expose the sensors to water or fluids, dust, and other contaminants. Accumulation of these in the sensor will affect the performance.

Always keep the Acoustic Sensor protected with the provided cover when the Imager is not in use. Avoid dust, grease or liquids on the microphones. If the microphones are dirty or clogged, carefully clean with low air pressure from a compressed air duster at 25 cm to 30 cm (10 in to 12 in) distance. Avoid too much air pressure.

To check the microphones:

1. Go to **Settings** menu.
2. Select **Test Microphones**.

If you see a warning message for service:

1. Clean the microphones with an air duster.
2. Test the microphones again. If the message continues, contact a Fluke Service Center. See [Contact Fluke](#) for more information.

Environmental

: For take-back programs in your country see www.fluke.com

Product Disposal

Dispose of the Product in a professional and environmentally sound manner:

- Delete personal data on the Product before disposal.
- Remove batteries that are not integrated into the electrical system before disposal and dispose of batteries separately.
- If this Product has an integral battery, put the entire Product in the electrical waste.

Service

Fluke recommends that you service the Imager at two-year intervals (depending on operating conditions) to maintain optimum performance.

Contact your equipment distributor or authorized Fluke Service Center for any equipment performance failure or to schedule regular maintenance service. See [Contact Fluke](#) for more information.

Fluke Premium Care

Fluke Premium Care extends beyond the typical product warranty, offering a comprehensive service agreement for a variety of Fluke products. Premium Care includes (depending on type of product and geographic availability) priority services, extended warranty coverage, calibration assistance, and access to loaner units during repairs. For further details on Fluke Premium Care and its features, please visit the Fluke website at www.fluke.com/premiumcare or contact the Fluke Customer Care Center.