



Mini2 V2/Mini2Plus V2/MiniE

User Manual



Contact Us

CONTENTS

1	Introduction	1
1.1	Thermal Imager and HIKMICRO Viewer	1
1.2	Download HIKMICRO Viewer.....	1
1.3	Connect Thermal Imager and HIKMICRO Viewer	2
1.4	User Manual	2
2	Live View.....	3
2.1	Live View	3
2.1.1	Live View Interface	4
2.1.2	Adjust Image Display	5
2.1.3	Thermal Image Calibration	6
2.1.4	Select Palettes	7
2.1.5	Adjust Display Temperature Range	7
2.1.6	Set Image Parameters.....	8
3	Temperature Measurement.....	8
3.1	Set Temperature Measurement Parameters	8
3.2	Measure Temperature	9
3.2.1	Add Point Measurement Tool.....	9
3.2.2	Add Line Measurement Tool.....	9
3.2.3	Add Rectangle Measurement Tool.....	10
3.2.4	Set Temperature Alarm (Optional)	10
4	Capture Snapshots and Record Videos.....	12
4.1	Capture Snapshots	12
4.2	Record Videos	12
4.3	View Snapshots/Videos	12
4.4	Edit Snapshots	13
4.5	Share Snapshots and Videos	13
4.6	Generate and Share PDF Report	14
5	Update and Maintenance.....	15
5.1	Update the Imager	15
5.2	Reset the Imager	15
5.3	Error Diagnosis.....	15

1 Introduction

1.1 Thermal Imager and HIKMICRO Viewer

The thermal imager (hereinafter refers to as **the Device** or **the Imager**) is an infrared thermal camera connected to mobile devices like smartphones or pads with Android or iOS systems through Type-C and Lightning connectors.

The imager needs to work with the HIKMICRO Viewer (hereinafter refers to as **the APP**).

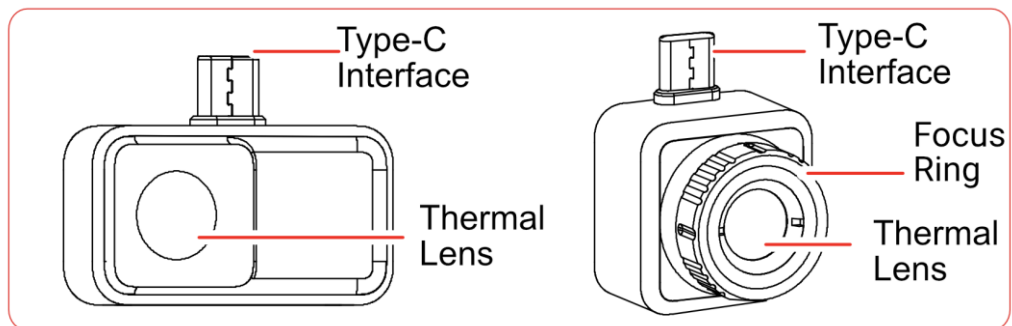

Figure 1-1 Thermal Imager Appearance



This manual describes and explains the features for multiple thermal imagers.

1.2 Download HIKMICRO Viewer

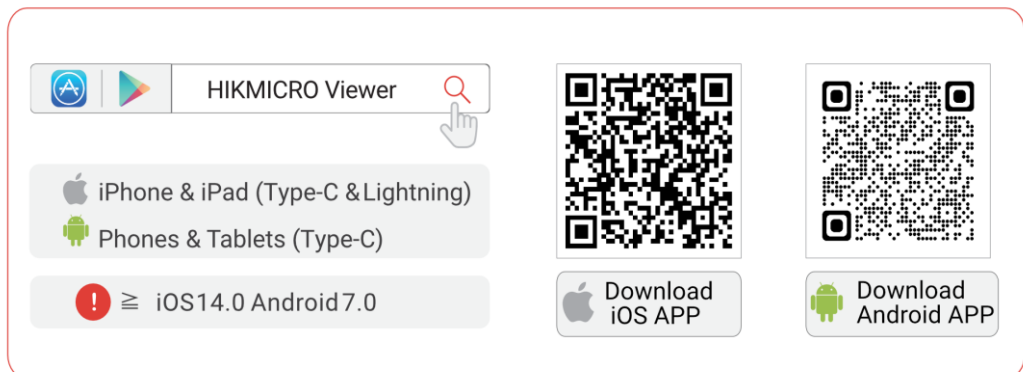

Figure 1-2 HIKMICRO Viewer QR Code

1.3 Connect Thermal Imager and HIKMICRO Viewer

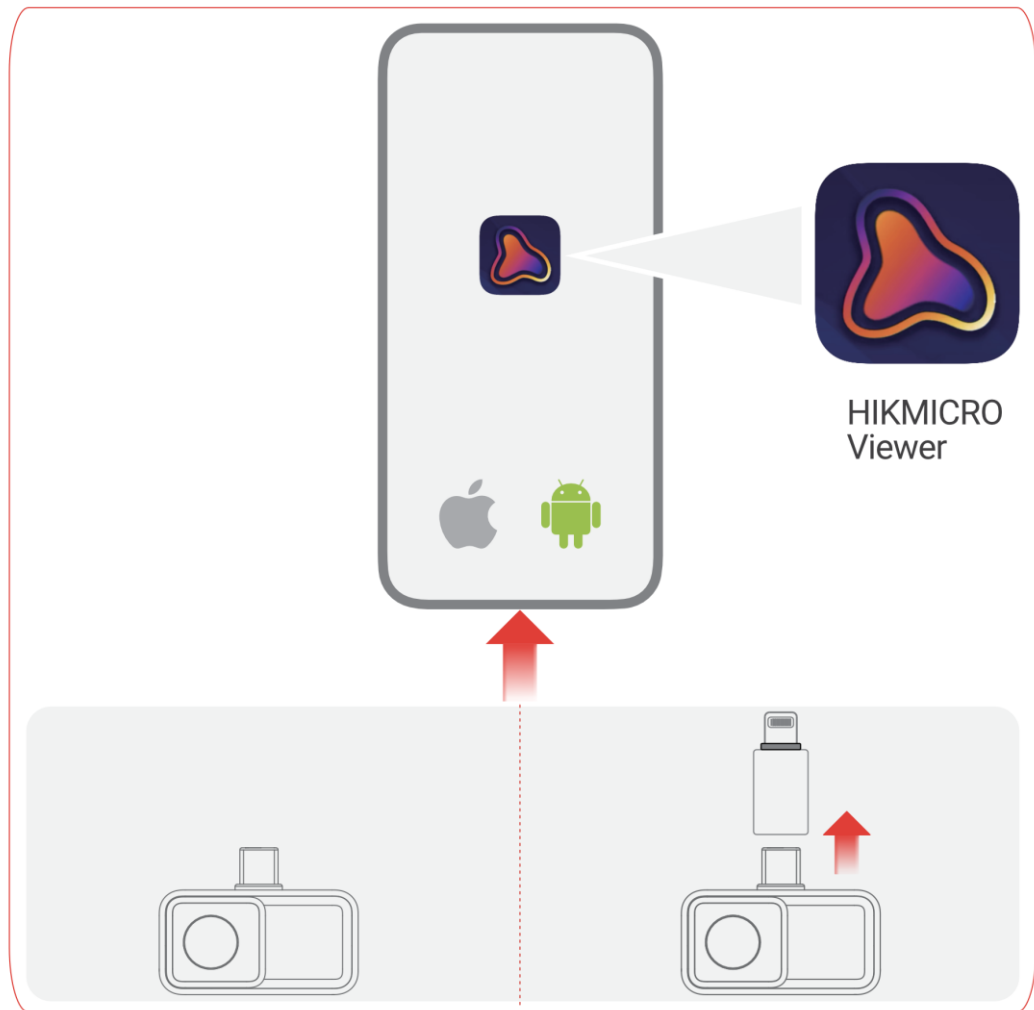

Figure 1-3 Connect Thermal Imager to the APP



- The thermal imager in figure above is for demonstration ONLY.
- If connected successfully, "Connected" will show on the home screen.

1.4 User Manual

In the home screen, tap **Device Info** > **Help** for detailed information about the device.

2 Live View

2.1 Live View

In **Live View**, you can adjust and calibrate thermal image, measure temperatures, change palettes, etc.

2.1.1 Live View Interface

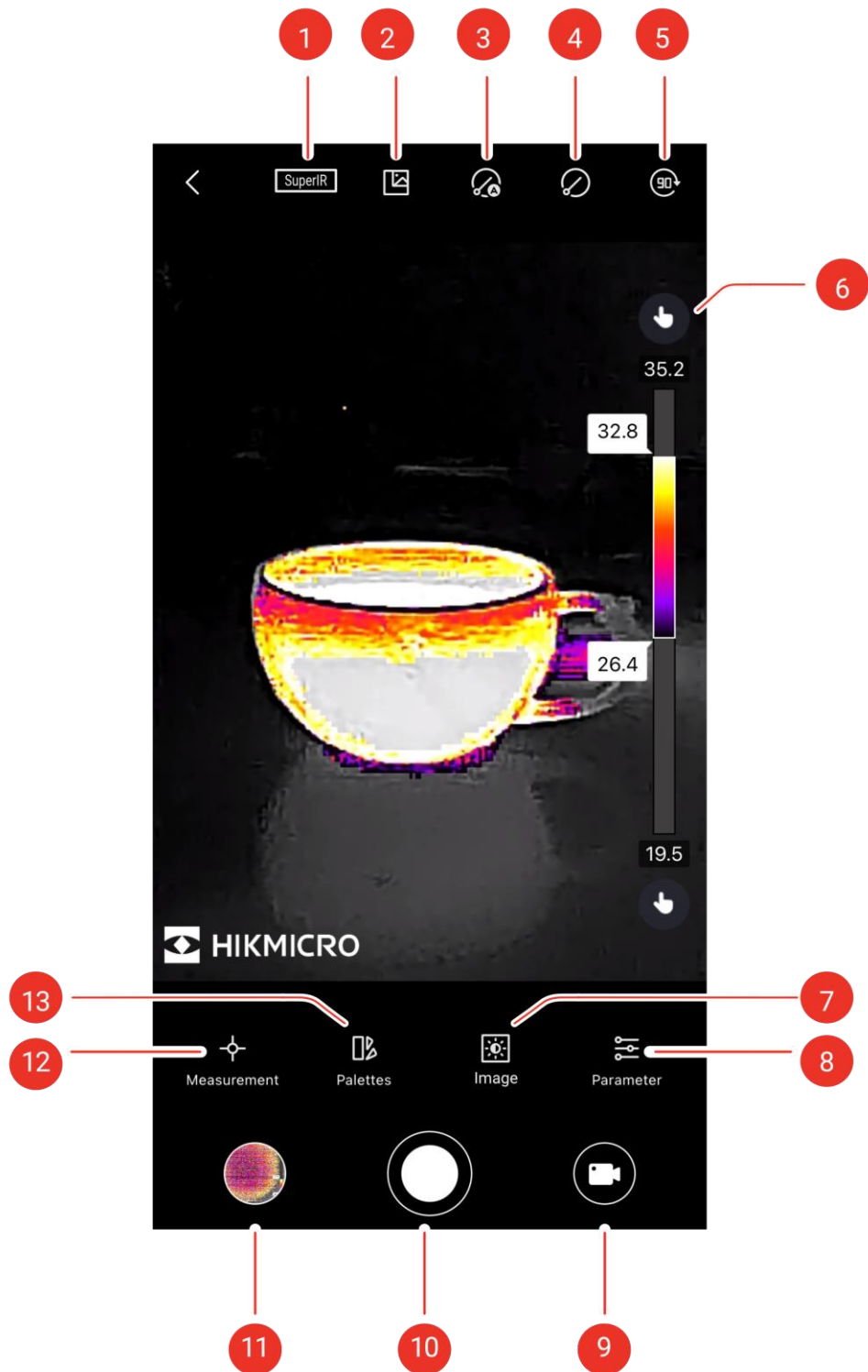



Figure 2-1 Live View Interface

Table 2-1 Live View Interface Icons

No.	Functions	Description
1	SuperIR	Enhance the object outlines for better image display.
2	Digital Camera	View the digital camera image of your phone.
3	Auto Calibration	The device will automatically implement Flat Field Calibration (FFC) after you turn it on.
4	Manual Calibration	The device will implement Flat Field Calibration (FFC) one time after you tap the icon.
5	Image Rotation	The thermal image rotates by 90 degrees.
6	Palattes and Display Temperature Range	Auto  : Display temperature range will be automatically adjusted Manual  : Drag the temperature value to adjust temperature range. In manual adjustment, the palette turns to focus palette mode, in which objects falling in the range remain the selected palette while the rest is displayed in white hot palette.
7	Image	Adjust brightness, sharpness, contrast and color distribution.
8	Parameter	Set parameters for real-time temperature measurement.
9	Record	Record videos.
10	Camera	Take snapshots.
11	Album	View sanpshots and videos.
12	Measurement	Set rules for temperature measurement.
13	Palettes	Select color styles for thermal imaging.

2.1.2 Adjust Image Display

Focusing Adjustment (for Some Imagers)

Aim the thermal lens to your target, and rotate the focus ring to make the image clear.

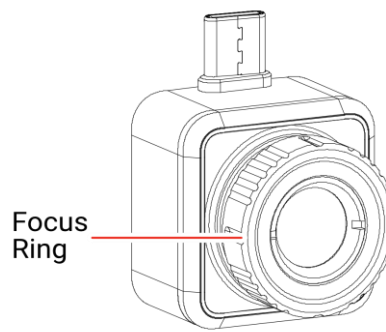



Figure 2-2 Thermal Imager with a Focus Ring



Focusing adjustment is ONLY supported by the imager with a focus ring.

Image Rotation

Tap  to rotate live image by 90 degrees.

SuperIR

Switch on  to get an enhanced thermal image.

2.1.3 Thermal Image Calibration

For temperature measurement accuracy and image effect, it is recommended to conduct image calibration. It is common to have brief image freeze during image calibration.

Auto Calibration

In this mode, the imager automatically calibrates images according to its internal rules.

Tap  to enable **Auto Calibration**. Tap it again to turn off the function.

Manual Calibration

Tap  to calibrate the image for one time.



It is recommended to enable **Auto Calibration**. Otherwise, you need conduct **Manual Calibration** from time to time for the accuracy of thermal imaging and temperature measurement.

2.1.4 Select Palettes

Palettes highlights the imaging details as the image displays different colors according to temperature range.

Tap  to select appropriate palettes.

Custom Palettes and predefined palettes are available.

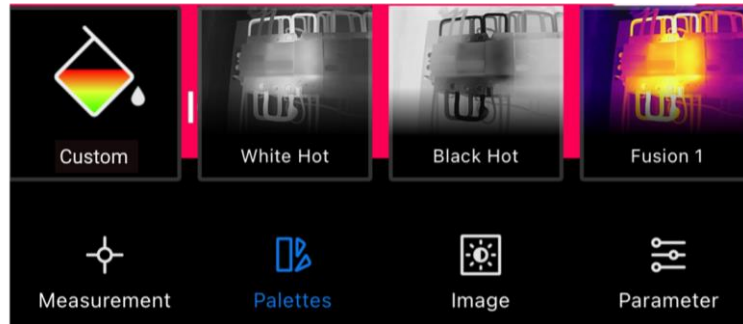

Figure 2-3 Different Palettes



- NO MORE THAN 4 colors are supported to set in the **Custom Palettes**.
 - Tap **Custom Palettes** >  to add appropriate colors. Swipe the palettes points to adjust the color distribution of the palettes bar.
-



Figure 2-4 Custom Palettes

2.1.5 Adjust Display Temperature Range

After selecting appropriate palettes, it is advisable to adjust display temperature range to highlight the thermal image of the target of interest.

Auto Adjustment

Tap , the imager will shift to **Auto Adjustment**, and the display temperature range will be automatically adjusted.

Manual Adjustment

Tap , the imager will shift to **Manual Adjustment**. It is a focus palette that you can swipe the temperature value up and down to adjust the range, focusing on the target in the set range.

2.1.6 Set Image Parameters

For better image analysis, it is recommended to tap  to set appropriate parameters:

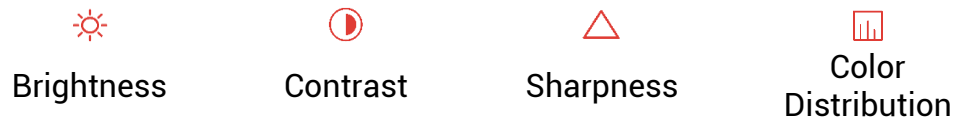

Color Distribution supports **Linear** and **Histogram**:

- **Linear:** The mode displays relatively huge temperature gap.
 - **Histogram:** The mode displays relatively small temperature gap.
-

3 Temperature Measurement

3.1 Set Temperature Measurement Parameters





For more accurate measurement, tap  to set parameters before temperature measurement.

Table 3-1 Temperature Measurement Parameters

ICON	Function	Description
	Distance	Set the distance (unit: m) between the target and the imager.
	Emissivity	Select or customize the emissivity of the target.
	Temperature Range	Set the temperature range of targets.
	Temperature Unit	Set temperature unit. You can select °C, °F, or K.

3.2 Measure Temperature

Measure temperature with tools. Available tools are **Point**, **Line** and **Rectangle**.

3.2.1 Add Point Measurement Tool





1. Tap  to add point tools.

Table 3-2 Point Measurement Tools

Icon	Function	Description
	Center Point	Display the real-time temperature of the center of the live image.
	Hot Point	Display the real-time highest temperature in the Live View .
	Cold Point	Display the real-time lowest temperature in the Live View .
	Custom Point	Display the temperature of a user-defined point.





Tap  to clear all measurement tools.

2. **Optional:** Edit the point

Move Point: Drag or tap the point to desired locations.

Remove Point:

- Tap  again to turn off the custom mode
- Tap the point
- Tap the pop-up  button



NO MORE THAN 3 custom points are supported to set on the **Live View**.

3.2.2 Add Line Measurement Tool

1. Tap  >  to add a line on the **Live View**

2. **Optional:** Edit the line

Move Line: Drag the line to move it

Resize Line: spread fingers apart and pinch them together to adjust its size.



Remove Line:

- Tap the line
- Tap  on the pop-up window to remove it

3. **Optional:** Show/Hide Temperature Result

- Tap the line
- Tap  to show/hide the highest/lowest/average temperature
- Tap **OK** to confirm the settings

3.2.3 Add Rectangle Measurement Tool

1. Tap  >  to add a rectangle on the **Live View**.

2. **Optional:** Edit the rectangle.

Move Rectangle:

- Drag the rectangle
- Tap any part outside of the rectangle to end the moving process

Resize Rectangle:

- Tap  to turn off the rectangle tool
- Tap the rectangle and drag its vertex
- Tap any part outside of the rectangle to end the resizing process

Remove Rectangle:

- Tap the rectangle, and it will pop up an edition window
- Tap  to remove it

3. **Optional:** Show/Hide Temperature Result



- Tap the rectangle, and it will pop up an edition window.
- Tap  to show/hide the highest/lowest/average temperature
- Tap **OK** to confirm the settings



NO MORE THAN 3 rectangles are supported to set on the **Live View**.

3.2.4 Set Temperature Alarm (Optional)

The exceptional temperature will cause the flashing **High Temp** or **Low Temp** at the bottom of the **Live View** and the vibration.

1. Tap .
2. Tap  to input the maximum value of **High Temp** and the minimum value of **Low Temp** in the pop-up window.



Threshold range of temperature exception alarm is -20°C ~ 400°C.

- Slide  to switch on the **High Temp** alarm or the **Low Temp** Alarm respectively.



It does NOT support to enable **High Temp** alarm and **Low Temp** alarm at the same time.

- Tap **OK** to confirm the settings.

4 Capture Snapshots and Record Videos

4.1 Capture Snapshots

If you need to save snapshots to your phone, please click **Settings > General > Save Pictures to Phone**.

Tap  to capture thermal images and save them to the APP album and your phone.

4.2 Record Videos

1. Tap  to shift into **Video** mode.

2. Tap  to start the video recording, and tap again to stop.



Snapshot and **Video** modes can be freely switched around.

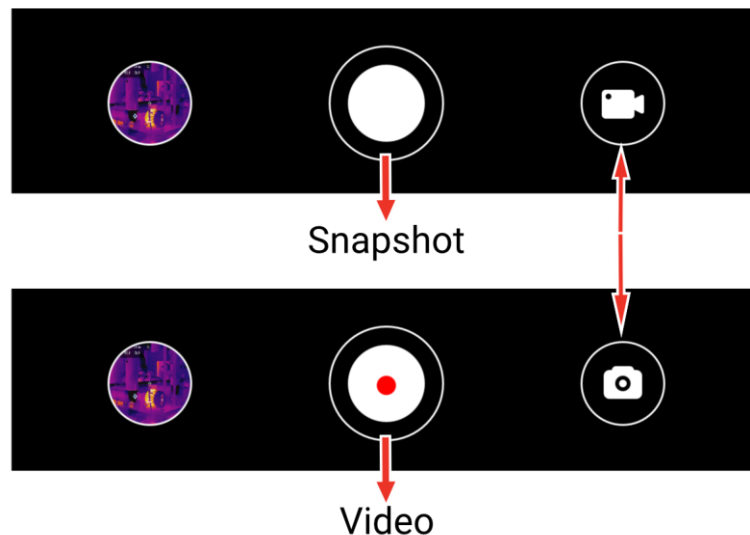



Figure 4-1 Switch Between Snapshot and Video Modes

4.3 View Snapshots/Videos

You can view the pictures and videos saved in the album as follows:

- Tap the snapshot or video on the lower left corner on the **Live View**.

- Tap the snapshot or video on the lower left corner on the **Live View**, then tap , and you can view all the snapshots and videos.
- Tap  in the home scree, and you can view all the snapshots and videos

4.4 Edit Snapshots

You can adjust the parameters of the snapshot to get more accurate temperature results.







1. Enter to the **Album** and select the snapshot.
2. Tap  to enable editing functions.



Table 4-1 Icons for Snapshots Editing

Icon	Function	Description
	Measurement	Adjust the temperature values on the rectangular box on the Live View . Tap again to hide the results.
	Image Mode	Select image modes, including Thermal, Fusion, PIP and Visual .
	Level and Span	Select Auto, Manual and 1-Tap modes to highlight certain temperature range.
	Palettes	Select palettes (16 modes in total).
	Color Alarms	Set the highest and lowest temperature or certain temperature range of the snapshot to highlight the required areas.
	Parameter	Adjust emissivity, distance, environment temperature and temperature unit. You can also remark on the picture.



- **Video** does NOT support editing functions.
- The temperature range of **Color Alarms** is -20°C ~ 150°C.

4.5 Share Snapshots and Videos



1. Enter to **Albums**, and tap  to select the snapshots and videos.
2. Tap  to share the snapshots and videos with the third party.
3. **Optional:** Tap  to save snapshots and videos to your phone.

4.6 Generate and Share PDF Report

1. Enter to the **Album** and select the snapshot.
2. Tap  to edit the report information.



File Name is a MUST.

3. Tap **Next** >  to generate a PDF report.
4. Tap  to share the report with the third party.



Video does NOT support PDF report generation and sharing.

5 Update and Maintenance

5.1 Update the Imager

For better operation experience, it is recommended to update to the latest version in time. The imager update is as follows:

- In the home screen, tap **Device Upgrade > Check for Updates**.
- In the home screen, tap **Device Info > Device Upgrade > Check for Updates**.

5.2 Reset the Imager

Tap **Device Info > Reset > OK** to restore the thermal imager.



Be careful to use this function, or the data will be lost.

5.3 Error Diagnosis

If you encounter some device exception during the operation, error diagnosis can help you quickly troubleshoot. Feedback paths are as follows:

- In the home screen, tap **Device Info > Log Diagnosis**.
- In the home screen, tap **Settings > Contact Us** to get online service support, hotline support or to submit logs.

Legal Statement

©Hangzhou Microimage Software Co., Ltd. All rights reserved.

About this Manual

The Manual includes instructions for using and managing the Product. Pictures, charts, images and all other information hereinafter are for description and explanation only. The information contained in the Manual is subject to change, without notice, due to firmware updates or other reasons. Please find the latest version of this Manual at the HIKMICRO website (www.hikmicrotech.com/).

Please use this Manual with the guidance and assistance of professionals trained in supporting the Product.

Trademarks Acknowledgement

 **HIKMICRO** and other HIKMICRO's trademarks and logos are the properties of HIKMICRO in various jurisdictions.

Other trademarks and logos mentioned are the properties of their respective owners.

LEGAL DISCLAIMER

TO THE MAXIMUM EXTENT PERMITTED BY APPLICABLE LAW, THIS MANUAL AND THE PRODUCT DESCRIBED, WITH ITS HARDWARE, SOFTWARE AND FIRMWARE, ARE PROVIDED "AS IS" AND "WITH ALL FAULTS AND ERRORS". HIKMICRO MAKES NO WARRANTIES, EXPRESS OR IMPLIED, INCLUDING WITHOUT LIMITATION, MERCHANTABILITY, SATISFACTORY QUALITY, OR FITNESS FOR A PARTICULAR PURPOSE. THE USE OF THE PRODUCT BY YOU IS AT YOUR OWN RISK. IN NO EVENT WILL HIKMICRO BE LIABLE TO YOU FOR ANY SPECIAL, CONSEQUENTIAL, INCIDENTAL, OR INDIRECT DAMAGES, INCLUDING, AMONG OTHERS, DAMAGES FOR LOSS OF BUSINESS PROFITS, BUSINESS INTERRUPTION, OR LOSS OF DATA, CORRUPTION OF SYSTEMS, OR LOSS OF DOCUMENTATION, WHETHER BASED ON BREACH OF CONTRACT, TORT (INCLUDING NEGLIGENCE), PRODUCT LIABILITY, OR OTHERWISE, IN CONNECTION WITH THE USE OF THE PRODUCT, EVEN IF HIKMICRO HAS BEEN ADVISED OF THE POSSIBILITY OF SUCH DAMAGES OR LOSS.

YOU ACKNOWLEDGE THAT THE NATURE OF THE INTERNET PROVIDES FOR INHERENT SECURITY RISKS, AND HIKMICRO SHALL NOT TAKE ANY

RESPONSIBILITIES FOR ABNORMAL OPERATION, PRIVACY LEAKAGE OR OTHER DAMAGES RESULTING FROM CYBER-ATTACK, HACKER ATTACK, VIRUS INFECTION, OR OTHER INTERNET SECURITY RISKS; HOWEVER, HIKMICRO WILL PROVIDE TIMELY TECHNICAL SUPPORT IF REQUIRED.

YOU AGREE TO USE THIS PRODUCT IN COMPLIANCE WITH ALL APPLICABLE LAWS, AND YOU ARE SOLELY RESPONSIBLE FOR ENSURING THAT YOUR USE CONFORMS TO THE APPLICABLE LAW. ESPECIALLY, YOU ARE RESPONSIBLE, FOR USING THIS PRODUCT IN A MANNER THAT DOES NOT INFRINGE ON THE RIGHTS OF THIRD PARTIES, INCLUDING WITHOUT LIMITATION, RIGHTS OF PUBLICITY, INTELLECTUAL PROPERTY RIGHTS, OR DATA PROTECTION AND OTHER PRIVACY RIGHTS. YOU SHALL NOT USE THIS PRODUCT FOR ILLEGAL HUNTING ANIMALS, INVASION OF PRIVACY OR ANY OTHER PURPOSE WHICH IS ILLEGAL OR DETRIMENTAL TO THE PUBLIC INTEREST. YOU SHALL NOT USE THIS PRODUCT FOR ANY PROHIBITED END-USES, INCLUDING THE DEVELOPMENT OR PRODUCTION OF WEAPONS OF MASS DESTRUCTION, THE DEVELOPMENT OR PRODUCTION OF CHEMICAL OR BIOLOGICAL WEAPONS, ANY ACTIVITIES IN THE CONTEXT RELATED TO ANY NUCLEAR EXPLOSIVE OR UNSAFE NUCLEAR FUEL-CYCLE, OR IN SUPPORT OF HUMAN RIGHTS ABUSES.

IN THE EVENT OF ANY CONFLICTS BETWEEN THIS MANUAL AND THE APPLICABLE LAW, THE LATTER PREVAILS.

Regulatory Information

These clauses apply only to the products bearing the corresponding mark or information.

FCC Compliance Statement

Please take attention that changes or modification not expressly approved by the party responsible for compliance could void the user's authority to operate the equipment. This device complies with Part 15 of the FCC Rules. Operation is subject to the following two conditions:

- (1) This device may not cause harmful interference, and
- (2) This device must accept any interference received, including interference that may cause undesired operation.

Note: Due to the device size limit, the above statement may not be disclaimed on the device. This equipment complies with FCC radiation exposure limits set forth for an uncontrolled environment.

Note: This product has been tested and found to comply with the limits for a Class B digital device, pursuant to Part 15 of the FCC Rules. These limits are designed to provide reasonable protection against harmful interference in a residential installation. This product generates, uses, and can radiate radio frequency energy and, if not installed and used in accordance with the instructions, may cause harmful interference to radio communications. However, there is no guarantee that interference will not occur in a particular installation. If this product does cause harmful interference to radio or television reception, which can be determined by turning the equipment off and on, the user is encouraged to try to correct the interference by one or more of the following measures:

- Reorient or relocate the receiving antenna.
- Increase the separation between the equipment and receiver.
- Connect the equipment into an outlet on a circuit different from that to which the receiver is connected.
- Consult the dealer or an experienced radio/TV technician for help.

EU Conformity Statement



This product and - if applicable - the supplied accessories too are marked with "CE" and comply therefore with the applicable harmonized European standards listed under the Directive 2014/30/EU (EMCD), Directive 2014/35/EU (LVD),



Directive 2011/65/EU (RoHS).

This product and - if applicable - the supplied accessories too are marked with "UKCA" and comply therefore with the following directives: Radio Equipment Regulations 2017, Electromagnetic Compatibility Regulations 2016, Electrical Equipment (Safety) Regulations 2016, the Restriction of the Use of Certain Hazardous Substances in Electrical and Electronic Equipment Regulations 2012.

Frequency Bands and Power (for CE/UKCA)

The frequency bands and transmitting power (radiated and/or conducted) nominal limits applicable to the following radio equipment are as follows:

Wi-Fi 2.4 GHz (2.4 GHz to 2.4835 GHz), 20 dBm

For the device without a supplied power adapter, use the power adapter provided by a qualified manufacturer. Refer to the product specification for detailed power requirements.

For the device without a supplied battery, use the battery provided by a qualified manufacturer. Refer to the product specification for detailed battery requirements.



Directive 2012/19/EU (WEEE Directive): Products marked with this symbol cannot be disposed of as unsorted municipal waste in the European Union. For proper recycling, return this product to your local supplier upon the purchase of equivalent new equipment, or dispose of it at designated collection points. For more information see: www.recyclethis.info

According to the Waste Electrical and Electronic Equipment Regulations 2013: Products marked with this symbol cannot be disposed of as unsorted municipal waste in the United Kingdom. For proper recycling, return this product to your local supplier upon the purchase of equivalent new equipment, or dispose of it at designated collection points. For more information see: www.recyclethis.info.



Directive 2006/66/EC and its amendment 2013/56/EU (Battery Directive): This product contains a battery that cannot be disposed of as unsorted municipal waste in the European Union. See the product documentation for specific battery information. The battery is marked with this symbol, which may include lettering to indicate cadmium (Cd), lead (Pb), or mercury (Hg). For proper recycling, return the battery to your supplier or to a designated collection point. For more information see: www.recyclethis.info.

According to the Batteries and Accumulators (Placing on the Market) Regulations 2008 and the Waste Batteries and

Accumulators Regulations 2009: This product contains a battery that cannot be disposed of as unsorted municipal waste in the United Kingdom. See the product documentation for specific battery information. The battery is marked with this symbol, which may include lettering to indicate cadmium (Cd), lead (Pb), or mercury (Hg). For proper recycling, return the battery to your supplier or to a designated collection point. For more information see: www.recyclethis.info.

Industry Canada ICES-003 Compliance

This device meets the CAN ICES-3 (A)/NMB-3(A) standards requirements.

Safety Instruction

These instructions are intended to ensure that user can use the product correctly to avoid danger or property loss.

Transportation

- Keep the device in original or similar packaging while transporting it.
- Keep all wrappers after unpacking them for future use. In case of any failure occurred, you need to return the device to the factory with the original wrapper. Transportation without the original wrapper may result in damage on the device and the company shall not take any responsibilities.
- Do not drop the product or subject it to physical shock. Keep the device away from magnetic interference.

Power Supply

- Input voltage should meet the Limited Power Source (5 VDC, 2 A) according to the IEC62368-1 standard. Please refer to technical specifications for detailed information.
- Make sure the plug is properly connected to the power socket.
- DO NOT connect multiple devices to one power adapter, to avoid overheating or fire hazards caused by overload.
- Use the power adapter provided by qualified manufacturer. Refer to the product specification for detailed power requirements.



HIKMICRO

See the World in a New Way