



ETHERSCOPE[®] nXG

User Guide

Tap a [link](#) to go directly to the app's chapter.
Scroll down to view the full list of Contents.



NetAlly Network Testing Apps



[AutoTest](#)



[Ping/TCP](#)



[Capture](#)



[Discovery](#)



[Wi-Fi](#)



[Path Analysis](#)



[AirMapper™](#)



[Spectrum](#)



[Performance](#)



[iPerf](#)



[LANBERT™](#)



[Link-Live](#)



[App Store](#)



[Cable Test](#)

Software v2.6. Published September 19, 2024

Contents

Contact Us	16
Introduction	17
Activating Your EtherScope Support ...	18
How to Use this Guide	19
Differences Between Models	23
Buttons and Ports	24
Charging and Power	29
PoE Charging	29
Safety and Maintenance	32
Legal Notification	35
Home and System Interface	36
Home Screen	37
Navigating the System	39
System Status Bar and Notifications ...	43
Notification Panel	43
Apps Screen and Store	46
Device Settings	50
Quick Settings Panel	51
Connecting to Wi-Fi	55
Captive Portals	58
Configuring for Enterprise Security ...	59

Sharing	68
Sharing a Screenshot	71
Changing the Device Language	73
EtherScope nXG Settings and Tools ..	75
Navigation Drawer	76
About Screen	78
Exporting Logs	79
Import/Export for All Apps	79
Restarting the Test Unit	80
Test and Management Ports	81
Test Ports	82
Selecting Ports	87
Test and Port Status Notifications	90
Test Port Notifications	91
Management Port Notifications	93
Discovery Notifications	95
PoE	95
VNC/Link-Live Remote	95
EtherScope nXG General Settings	97
Wi-Fi General Settings	98
Wired General Settings	103
Management	106

Preferences	109
Trending Graphs	111
Common Icons	115
Floating Action Button (FAB) and Menu	116
Common Tools	118
Web Browser/Chromium	118
Telnet/SSH	118
Camera and Flashlight	120
Software Management	121
Managing Files	122
Files Application	122
How to Move or Copy a File	125
Using a Micro SD Card	126
Using a USB Drive	127
Ejecting Storage Media	129
Using a USB Type-C to USB Cable	129
Updating Software	132
Remote Access	137
Using VNC	139
Using Link-Live Remote	139
Managing NetAlly App Settings	142
Resetting Testing App Defaults	142

Saving App Settings and Configurations	146
Import/Export Settings	150
Import/Export Settings for All Apps ..	160
Resetting EtherScope nXG Factory Defaults	162
EtherScope nXG Feature Access ...	165
Introduction to Feature Access	166
Controlling Feature Access	173
Changing the Administrative Password	178
EtherScope nXG Testing Applications	181
AutoTest App and Profiles	182
AutoTest Overview	184
Managing Profiles and Profile Groups ..	187
Factory Default Profiles	187
Adding New Profiles	189
Profile Groups	195
Creating New Profile Groups	200
Import/Export AutoTest Profiles	203
Main AutoTest Screen	204
Periodic AutoTest	206

Periodic AutoTest Settings	206
Running Periodic AutoTest	208
Wi-Fi AutoTest Profiles	211
Wi-Fi Profile Settings	215
Wi-Fi Connection Settings	217
Advanced (Wi-Fi Connection) Settings	228
Channel Test Settings	232
HTTP Proxy	235
Wi-Fi Profile Test Results	237
Wi-Fi Link Test Results	240
Connect Log	251
Channel Test Results	252
Other Actions (Wi-Fi Profile FAB)	258
Wired AutoTest Profiles	262
Wired Profile Settings	266
PoE Test Settings	267
Wired Connection Settings	270
VLAN Settings	277
Stop After	279
HTTP Proxy	280
Wired Profile Test Results	282
PoE Test Results	284
Wired Link Test Results	287

802.1X Test Results	293
VLAN Test Results	295
Switch Test Results	298
Wired Profile FAB	305
DHCP, DNS, and Gateway Tests	309
DHCP or Static IP Test	310
DNS Test	324
Test Targets for Wired and Wi-Fi	
AutoTest	335
Adding and Managing Test Targets ...	336
AutoTest TCP Connect Test	349
FTP Test	366
Air Quality AutoTest Profiles	376
Air Quality Profile Results	378
Viewing and Saving Results	382
Air Quality Profile Settings	384
Ping/TCP Test App	390
Ping/TCP Settings	391
Populating Ping/TCP from Another App	391
Configuring Ping/TCP Settings Manually	393
Running Ping/TCP Tests	396

Capture App	400
Capture Settings	401
Running and Viewing Captures	408
Discovery App	414
Introduction to Discovery	416
Main Discovery List Screen	418
Searching the Discovery List	421
Filtering the Discovery List	423
Sorting the Discovery List	426
Security Auditing – Batch Authorization	428
Refreshing Discovery	433
Uploading Results to Link-Live	434
Discovery Details Screens	436
Top Details Card	438
Lower Cards in Device Details	444
Problems	446
Addresses	447
TCP Port Scan	449
VLANs	451
Interfaces	452
SNMP	458

Connected Devices	459
Resources	460
SSIDs	461
Discovery App Floating Action Menu .	463
Device Types	468
Routers	469
Switches	470
Unknown Switches	471
Network Servers	472
Hypervisors	473
Virtual Machines	474
Wi-Fi Controllers	475
Access Points (APs)	476
Wi-Fi Clients	477
VoIP Phones	478
Printers	479
SNMP Agents	480
Network Tools	481
Hosts/Clients	482
Device Names and Authorization	485
Assigning a Name and Authorization to a Device	485
Discovery Settings	498

Active Discovery Ports	501
Extended Ranges	502
ARP Sweep Rate	506
Refresh Interval	506
SNMP Configuration	507
Auto AP Grouping Rules	518
Problem Settings	524
TCP Port Scan Settings	527
Wi-Fi Analysis App	530
Wi-Fi Analysis and Discovery	532
Wi-Fi App Screens	533
Wi-Fi App List Screens	534
Filtering in the Wi-Fi App	538
Sorting in the Wi-Fi App	543
Clearing All Problems	545
Setting Authorization	546
Uploading Results to Link-Live	547
Wi-Fi Details Screens	549
Wi-Fi Problems Screen	552
RF and Traffic Statistics Overview	554
Locating Wi-Fi Devices	559
Channels Map	570

Map and Map 6E Tabs	571
Channels	579
SSIDs	584
APs	589
BSSIDs	593
Clients	606
Bluetooth	615
Interferers	620
Path Analysis App	624
Introduction to Path Analysis	625
Path Analysis Settings	626
Populating Path Analysis from Another App	626
Configuring Path Analysis Manually ..	626
Running Path Analysis	629
Path Analysis Results and Source EtherScope Cards	631
Layer 3 Hops	634
Layer 2 Devices	639
Uploading Results to Link-Live	645
AirMapper™ App	647
AirMapper Settings	648

Configuring an AirMapper Survey	649
Collecting AirMapper Data	659
Spectrum Test App	676
Using the Spectrum Views	677
Uploading Results to Link-Live	685
Spectrum Settings	687
Changing Spectrum Views	687
Saving Settings	687
Changing Spectrum Settings	688
Performance Test App	691
Introduction to Performance Testing ..	693
Performance Test Settings	695
Saving Custom Performance Tests ...	696
Configuring the Source EtherScope nXG	701
Configuring Performance Endpoints ..	718
OneTouch 10G Performance Peer	719
LinkRunner G2 Reflector	721
LinkRunner AT Reflector	723
NPT Reflector Software	725
Running a Performance Test	727
Performance Test Results	728

Performance Service Detailed Results	730
Uploading Results to Link-Live	738
Running EtherScope nXG as a Performance Peer	742
iPerf Test App	746
iPerf Settings	748
Saving Custom iPerf Settings	748
Test Accessories in Discovery	749
Configuring iPerf Settings	752
Running an iPerf Test	757
Uploading Results to Link-Live	761
LANBERT™ Test App	763
LANBERT Settings	764
Configuring LANBERT Generator Settings	764
Configuring LANBERT Loopback Settings	769
Running a LANBERT Test	770
Uploading Results to Link-Live	777
Link-Live Cloud Service	780
Getting Started in Link-Live Cloud Service	782

Claiming the Unit	782
After Claiming	784
Unclaiming	785
AllyCare Code	786
Private Link-Live Settings	787
Link-Live App Features	788
Saving Locally Only	792
Job Comment	794
Link-Live and Testing Apps	797
Link-Live Sharing Screens	798
Sharing a Text File to Link-Live	801
Cable Test App	810
Cable Test Settings	811
Running Cable Test	813
Uploading Results to Link-Live	823
Switch App	824
Running Switch	825
Specifications and Compliance	828
EXG-200 Specifications	829
General	829
Wireless	830
Environmental Specifications	838

EXG-200 Certifications and Compliance	839
EXG-300 Specifications	844
General	844
Wireless	845
Environmental Specifications	853
EXG-300 Certifications and Compliance	855
Index	867

Contact Us

Online: NetAlly.com

Phone: (North America) 1-844-TRU-ALLY
(1-844-878-2559)

NetAlly

2075 Research Parkway, Suite 190
Colorado Springs, CO 80920

For additional product resources, visit:
NetAlly.com/Products/EtherScopenXG

For customer support, visit:
NetAlly.com/Support

Register your EtherScope nXG

Registering your product with NetAlly gives you access to valuable information on product updates, troubleshooting procedures, and other services.

Register on the [NetAlly Support Page](#).

Introduction

The EtherScope nXG Portable Network Expert is a rugged, hand-held tool for testing and analyzing copper, fiber, and Wi-Fi networks. It features applications developed by NetAlly for network discovery, measurement, and validation, which are available from the [Home](#) and [Apps](#) screens.

All NetAlly hand-held testers include access to Link-Live Cloud Service at Link-Live.com. Link-Live is an online system for collecting, organizing, analyzing, and reporting your test results. Test data is automatically uploaded once your tester is properly configured. Visit Link-Live.com and "Claim" your EtherScope to access these features.

Activating Your EtherScope Support

All EXG-300 models come with one year of NetAlly's AllyCare support. You must activate this support before you can start using your unit.

To activate support, go to the NetAlly support site:

<https://support.netally.com/Login/?type=customer>

Begin by typing your company email into the field for NEW USERS, and then click **Sign up**.

Follow the screen instructions to register your product. You will then receive an email with additional instructions to register and receive an activation code.

The first time you boot your EXG-300, you must enter the activation code before you can begin using your product. You can then use all features on your EtherScope.

How to Use this Guide

This user guide describes the EtherScope nXG's testing functionality and basic elements of the system interface.

The guide is meant for users who are knowledgeable about network operations, tests, and measurements.

The EtherScope nXG is also referred to as just EtherScope or the "unit" in this guide.

- Tap **blue links** to go to their destinations. [Underlined blue links](#) open external websites.
- Tap bookmarks in the list on the left to go to the corresponding section.
- Tap headings in the **Contents** list that starts on page 2 to go to the corresponding sections.
- To search for a word or phrase:
 1. Tap the browser menu  icon in the upper right.
 2. Select **Find in Page** from the menu.

3. Enter the search text.
4. Tap the find icon . This displays the text at the top of the screen. Tap the up and down arrows to search forwards and backwards for the text. In the image below, the user has searched on "LAN". Tap the highlight bars on the right to go to the corresponding manual text.

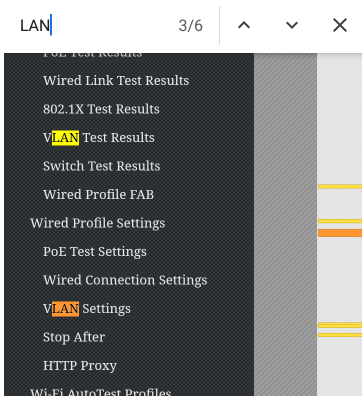

Online and Local Versions of This Guide, Videos

- Manuals are also available for download at: <https://www.netally.com/support/user-guides/>
- To view the User Guide on your EtherScope nXG, you must have a network connection with access to the internet (see [Connecting to Wi-Fi](#)). When you tap on **Guides > User Guide** on the [Home Screen](#), this user guide is downloaded and displays on your unit.
- After you have downloaded the User Guide to your unit, the guide is stored in a local cache for the browser. You do not have to repeat the download unless you [change the device language](#) or clear the browser cache.
- The Guides icon on the Home Screen (used to access this guide) also gives access to training and information videos specific to this product.

International Versions of This Guide

A Chinese or English EtherScope nXG user guide is available if you [change the device language](#) to one of those languages. The English user manual is used if you change the language to German, Japanese, or Korean.

Differences Between Models

The Model number of your EtherScope appears on the [About Screen](#) and is printed on the back panel of your unit. This manual covers all models and identifies features specific to each model if there are differences. In general:

- EXG-200: Supports 2.4 GHz and 5 GHz frequency bands; supports 802.11a/b/g/n/ac Wi-Fi standards.
- EXG-300: Supports 2.4 GHz, 5 GHz, and 6 GHz frequency bands; supports 802.11a/b/g/n/ac/ax Wi-Fi standards.
- EXG-300C: Supports 2.4 GHz and 5 GHz frequency bands; has same features as EXG-300; does not support 802.11d specification.
- EXG-300E: Supports 2.4 GHz, 5 GHz, and 6 GHz frequency bands, limited by 802.11d regional domain specification; supports 802.11a/b/g/n/ac/ax Wi-Fi standards.

For more information, see [EXG-200 Specifications](#) and [EXG-300 Specifications](#).

Buttons and Ports

Button and port functions on your EtherScope unit are described below.

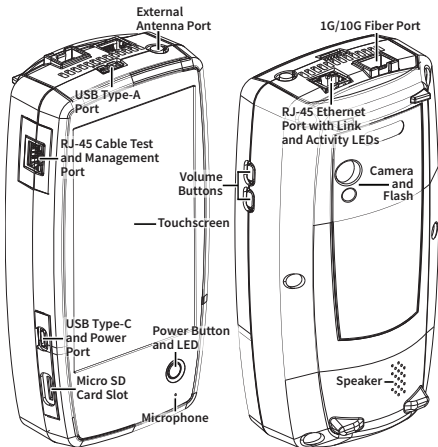

FEATURE	DESCRIPTION
Fiber Port 1G/10GBASE-X	Connects to an SFP adapter and fiber cable for network testing. NOTE: 100FX SFPs are not supported.
RJ-45 LAN Port 10M/100M/1G/ 2.5G/5G/10G- BASE-T	Connects to a copper Ethernet cable for network testing Supports PoE (with compatible unit hardware)
Transmit LEDs	Green LED lit: Linked Yellow LED flashing: Activity
USB Type-A Port	Connects to any USB device
RJ-45 Cable Test and Management Port	Connects to an Ethernet cable for patch cable testing and unit management
USB Type-C On-the-Go Port	Connects to a USB Type-C connector for file transfer and to the included AC adapter for charging the unit
Microphone	Allows voice input
Camera and Flashlight	Captures images and acts as a flashlight
Micro SD Card Slot	Used for removable storage expansion (See Inserting a Micro SD Card below.)

FEATURE	DESCRIPTION
Volume Buttons	Increase or decrease the audio volume
Speaker	Produces audio
Power Button	Press and hold to display menu for Power off or Restart
	Green LED: Unit is powered on
	Red LED: Unit is charging

See [Test and Management Ports](#) for detailed explanations of the port functions.

See [Updating Software](#) for requirements on updating system software.

Refer to the product [Specifications](#) if needed.

Inserting a Micro SD Card

A Micro SD card must be inserted with the *metal contacts facing the front* (towards the touchscreen) of the unit, as shown below.

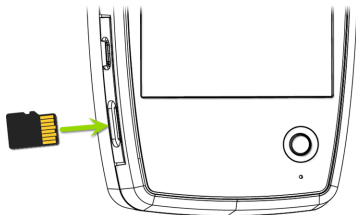

The card should slide in easily when properly oriented. You may need a paperclip or thumbnail to carefully push the SD card in far enough to engage the spring mechanism for insertion and removal.

Using a Kensington Lock

The slot for a standard Kensington lock is the right front vent hole on the bottom of the unit, as shown below.

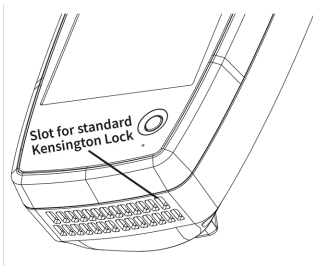

Charging and Power

Your EtherScope nXG includes a USB-C 15V/3A power adapter.

 **CAUTION:** Only the NetAlly-supplied power adapter is supported.

To begin charging the internal lithium-ion battery, plug the included power adapter into an AC outlet and the USB-C charging port on the left side of the unit. The Power button turns red when the unit is in charging mode and turns off at full charge. Refer to the [Specifications](#) for battery run duration and charge times.

PoE Charging

Power over Ethernet (PoE) can provide alternative power to your unit's battery. (Test units that include the **Charge Battery via PoE** setting in [General Settings](#), support PoE.)

- Negotiated PoE class levels 4-8 (≥ 25.5 W) provide enough power to run the test unit indefinitely and to charge the battery.

- Negotiated PoE class levels 0-3 (≤ 15.4 W) provide some power to extend battery run time but not enough to charge the battery.

Use the following steps to enable PoE charging:

1. Connect the top RJ-45 port on the unit to a network switch with PoE or to a PoE injector.
2. Make sure the unit is powered on or in display sleep mode.
3. If your test unit displays the **Charge Battery via PoE** setting in [General Settings](#), tap the setting to enable PoE charging.
4. Detect the PoE availability by running an [AutoTest Wired Profile](#) with a PoE test that passes. (The **PoE Test** must be enabled and configured with a **Powered Device Class** that is supported by your switch or PoE Injector.) See [Wired Profile Settings](#) and [Results](#).

NOTE: If the AutoTest app is not currently open, the last Wired Profile in the profile list runs automatically when you power on the

unit or EtherScope detects a new copper link in the top [Wired Test Port](#).

See [Buttons and Ports](#) for port locations and descriptions.

Powering On

- To start the unit, hold down the Power Button for approximately one second until the Power Button LED turns green.
- When the display goes into Sleep mode, the Power Button LED remains on. Tap the Power Button briefly to wake up the display. (Set the timing for display sleep and auto power off in the  [Device Settings](#).)
- To shut down or restart, hold down the Power Button for one second until the “Power off” and “Restart” dialog box appears on the touchscreen, and then tap **Power off** or **Restart**.
- If the unit is unresponsive to a normal power off, press and hold the Power Button for five seconds to perform a hard shutdown.

Safety and Maintenance

Observe the following safety information:

Use only the Adapter provided or Power over Ethernet (PoE) to charge the battery.

Ensure that the Adapter is easily accessible.

Use the proper terminals and cables for all connections.

 **CAUTION:** To avoid possible electric shock or personal injury, follow these guidelines:

- Do not use the product if it is damaged. Before using the product, inspect the case, and look for cracked or missing plastic.
- Do not operate the product around explosive gas, vapor, or dust.
- Do not try to service the product. There are no serviceable parts.
- Do not replace the battery. There is risk of explosion if the battery is replaced by an incorrect battery type.
- Dispose of battery packs and electronics in compliance with your institution's disposal instructions.

- Use as directed. If this product is used in a manner not specified by the manufacturer, the protection provided by the product may be impaired.

Safety Symbols



Warning or Caution: Risk of damage to or destruction of equipment or software.



Warning: Risk of electrical shock.



Not for connection to a public telephone system.



Class 1 Laser Product. Do not look into the laser.

Cleaning

To clean the display, use a lens cleaner and a soft, lint-free cloth.

To clean the case, use a soft cloth that is moist with water or a weak soap.

Scratches on the dark-colored plastic can be removed by *lightly* scrubbing a 1:2 mixture of

toothpaste to water onto the affected surface with a bristled brush.

 **CAUTION:** Do not use solvents or abrasive materials that may damage the product.

Legal Notification

Use of this product requires acceptance of the Terms and Conditions available at <http://NetAlly.com/terms-and-conditions> or which accompanies the product at the time of shipment or, if applicable, the legal agreement executed by and between NetAlly and the purchaser of this product.

Open-Source Software Acknowledgment: This product may incorporate open-source components. NetAlly will make available open-source code components of this product, if any, at Link-Live.com/OpenSource.

NetAlly reserves the right, at its sole discretion, to make changes at any time in its technical information, specifications, service, and support programs.

© 2019-2024 NetAlly

Home and System Interface

This chapter explains how to use the features of the system Home screen and user interface to navigate and organize your device.

The EtherScope nXG interface supports many of the operations typical of any hand-held device. Use dragging and **swiping** motions on the touchscreen to navigate through apps, open side menus, drag down the **Notification Panel** from the Status Bar at the top of the Home screen, or drag up the **Apps** screen from the bottom.

Home Screen

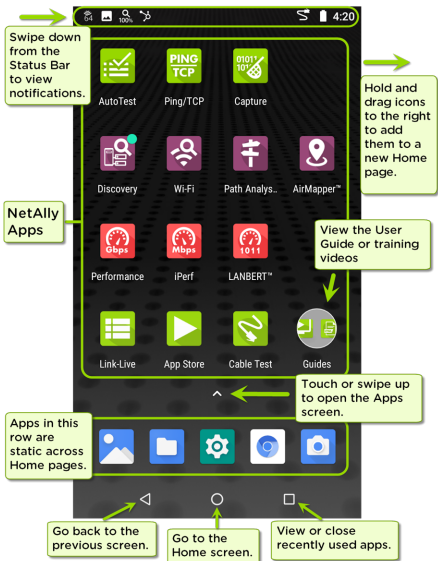

Like other hand-held devices, your EtherScope nXG Home screen is customizable. The image above shows the default configuration, but you

can add, remove, and reorganize app icons and widgets to serve your purposes.

You can also create more Home pages by tapping, holding, and dragging an app icon to the right from the main Home screen.

See the [Apps screen](#) section for instructions on adding more apps to your Home pages.

Navigating the System

The navigation actions you can perform to move through screens and panels on the EtherScope nXG are the same as those you would use to navigate many other phone or tablet devices.

The main device navigation buttons appear at the bottom of the touch screen.



The back icon returns to the previous screen.



The circle icon opens the Home screen.



The square icon displays your recently used applications for easily switching between them. This is also the screen where you can close, or stop, the open applications.

TIP: Double tap the square icon to switch back to the previous app you were using and to switch back and forth between two app screens (like a testing app and this User Guide).

Swiping

Touch and drag your finger or "swipe" up, down, left, and right to move through pages of the [Home screen](#) and applications, scroll up or down, and pull out navigation drawers and panels.

Long Pressing

Touch and hold or "long press" files or application icons to reveal additional operations.

For example, you can long press a file name in the [Files Application](#) to reveal the top toolbar with options for [sharing](#) , deleting, or moving the file.



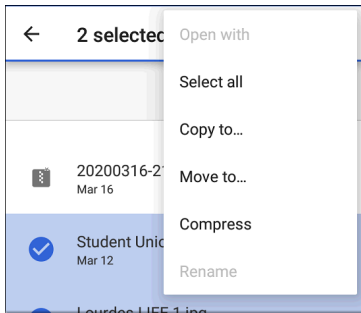

Additional options often appear in an overflow menu, designated by the action overflow icon .



You can also long press on text on most screens to open options for copying and [sharing](#) the text.

Left-Side Navigation Drawer

In the [Files](#)  app, tap the Menu icon  or or swipe right to open the navigation drawer. It displays the folders in your file system.

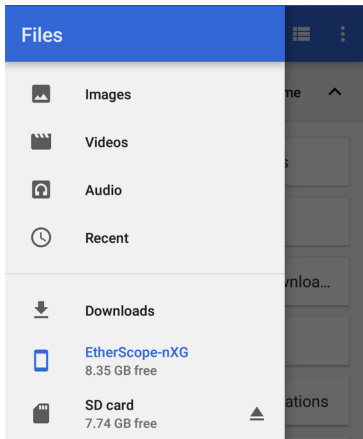

NOTE: In the Files app, you may need to tap the action overflow icon  at the top right and select **Show Internal Storage** to navigate to the **EtherScope-nXG** folder and sub-folders, as shown above.

See the [Navigation Drawer](#) topic for additional information.

System Status Bar and Notifications

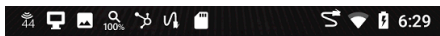

The Status Bar across the top of the screen displays notification icons from the system as well as EtherScope nXG-specific icons related to your network connections and test statuses.

See [Test and Port Status Notifications](#) for details about the icons and notifications related to EtherScope nXG network connections, testing, and management.

Tap and swipe down on the Status Bar to open the Notification Panel.

Notification Panel

The Notification Panel contains notifications from your device, such as downloads and installs, inserted hardware, captured screenshots, app and connection statuses, and updates. The panel also displays common system settings icons for quick access.

Swipe (touch and drag) downwards on the Status Bar at very top of the screen to slide down the Notification Panel.



NetAlly ^

Mode: Scanning Channel: 85E

Channel Width: 160 MHz

Tester System • 31m ▾

Screenshot captured.

Tap to view your screenshot.



Discovery

Discovery Status: 100%

NetAlly

Wired Management Port

IP Address: 192.168.0.106

Tester System ▾

SD card

For transferring photos and media

- Tap the title and down arrow ▾ on a notification (or swipe down on it) to expand the box and view more details or options.
- Tap the middle of a notification to open the related app, image, or device settings or to perform other related actions.

- Swipe left on a notification to dismiss it.
NOTE: Because they are essential to the EtherScope testing functions, you cannot dismiss the [test and management port-related test and port status notifications](#).
- Tap **CLEAR ALL** at the lower right of the panel to dismiss all system notifications.

Apps Screen and Store

To access the apps that are not shown on the Home screen, swipe up on the Home screen or tap the up arrow icon .

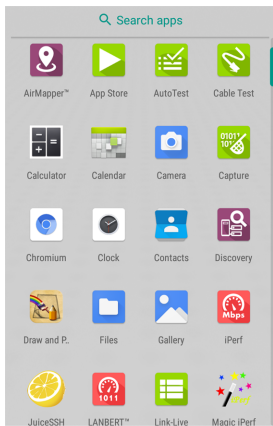

The Apps screen displays all the apps on your device. The image above is an example. Your Apps screen may contain different third-party apps.

- Tap an app's icon to open the app.
- Hold and drag an icon upwards to add it to your Home screens.
- Touch and hold (long press) an icon to view App Info or access widgets you can add to the Home screen and other actions you can perform.

App Store

From the Home Screen or Apps Screen, open the NetAlly  App Store to download third-party system applications to use on your EtherScope nXG.

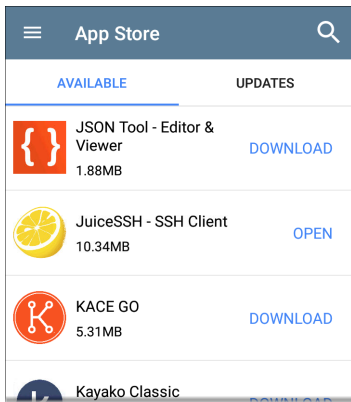

NOTE: Your unit must be "claimed" to [Link-Live Cloud Service](#) at Link-Live.com to access the App Store.

- Tap the search icon to search for an App.
- Tap **UPDATES** to view available updates of installed apps.
- To request that an App be added to the App Store, visit the Apps  page at [Link-](#)

[Live.com](https://www.live.com), and select the floating action button (FAB) at the lower right corner to

▶ **Request or Upload an App.**

Device Settings

To access the system device settings, tap the Settings  icon at the bottom of the [Home screen](#).

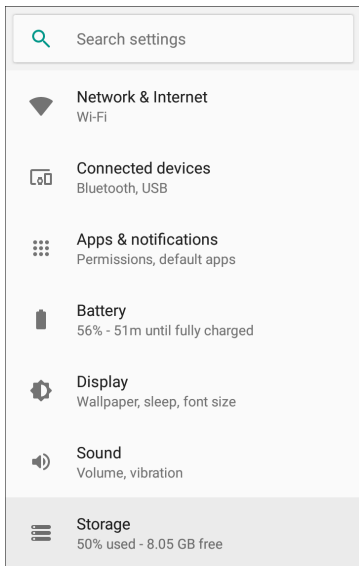

The device settings screen lets you adjust the display; adjust sound (including volume for external Bluetooth or USB speakers or headsets); set date and time; view installed applications and memory devices; [connect to Wi-Fi](#); or [reset to factory defaults](#).

Quick Settings Panel

You can also access some of the most common device settings, like Wi-Fi, from the Quick Settings Panel by swiping down from the [Status Bar](#) at the top of the touchscreen.

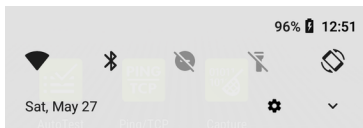

52 NetAlly ^

Mode: Scanning Channel: 52

Channel Width: 80 MHz

100% Discovery



Discovery Status: 100%

NetAlly v

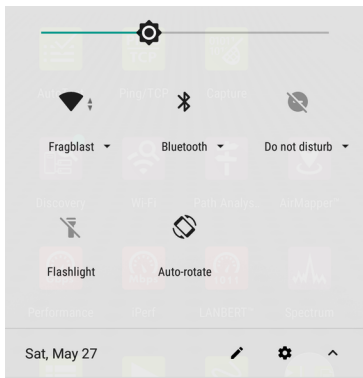
Swipe down twice to open the full Quick Settings Panel.



- Touch and drag the slider control at the top of the panel to adjust the screen's brightness.
- Tap an icon in the panel to enable or disable the corresponding feature. For example, you can turn the unit's **Wi-Fi**  functions on or off from the quick settings.

- Touch and hold an icon to open the relevant device setting screen, if there is one. For example, touch and hold the Auto-Rotate icon  to open Display settings.
- Tap the pencil icon  at the bottom of the Quick Settings Panel to configure the icon controls that appear in the panel.

Auto Power Off

Activating the Auto Power Off function helps to extend the battery run time.

1. From the Device Settings , select **Display**.
2. On the Display settings screen, tap **Device auto power off**.
3. In the pop-up dialog box, select how long you want the unit to remain On with no activity occurring. The unit automatically powers off after the selected period of inactivity has passed.

Similarly, you can adjust the setting that controls when the display goes into **Sleep** mode from the **Display** settings screen.

Language

Your device supports Chinese, English, German, Japanese, and Korean language displays. See [Changing the Device Language](#) for information on changing the device interface language. The user guide is available in Chinese and English. See [How to Use this Guide](#).

Connecting to Wi-Fi

Basic connectivity to Wi-Fi is done using the Wi-Fi Management Port (configured in the system network settings). The [Wi-Fi Management Port](#) is separate from the Wi-Fi test ports. It can access the internet, be used by other system applications, upload test results to the Link-Live website, and be used for remote control. The management port also provides a more stable network connection than the test port, which can change connections during AutoTests or be disconnected during Wi-Fi scanning. See [Test and Management Ports](#) for more information.

NOTE: NetAlly testing apps use the Wi-Fi Test Ports and Wi-Fi AutoTest Profiles to connect to Wi-Fi networks during testing. See [Test and Management Ports](#) for more information.

To connect your EtherScope to a Wi-Fi network:

1. Open the system Wi-Fi Device Settings using either method below:
 - Open the device Wi-Fi settings from the main [Device Settings](#) screen by tapping

the Settings icon  and selecting **Network & Internet > Wi-Fi**.

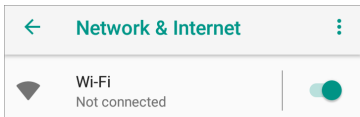

- Open device Wi-Fi settings from the [Quick Settings panel](#) by dragging down the top Status Bar and tapping and holding (long pressing) the Wi-Fi icon.

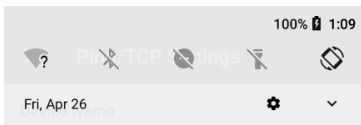

Either method opens the Wi-Fi settings screen:

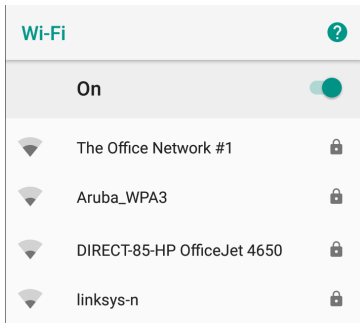

2. Ensure the Wi-Fi feature is **On**.
3. Tap an available Wi-Fi network in the list.
4. Enter the network's security credentials. (Most networks only require a password, but depending on the security settings, some may also require a company username, EAP type, authentication type, certificate, or other credentials.)
5. Tap **CONNECT**.

The network you selected moves to the top of the list, and your connection status is displayed below its name in device and quick settings.

The Status Bar displays the Wi-Fi status icon  at the top right of the screen.

Captive Portals

When you try to connect to a network with a Captive Portal requirement, this system notification icon  appears in the top [Status Bar](#). Drag down from the top of the screen to open the notification.

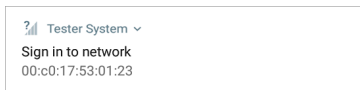

Tap the notification to open a web browser window where you can enter the required information for the captive portal. When finished, you can access the internet through the connected network.

If you are trying to connect to a network with a captive portal, but the system notification is not appearing, check that the **Captive Portal Detection** setting is enabled in [Device Settings](#)  > **Network & Internet**.

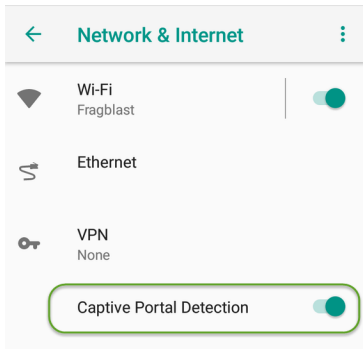

Configuring for Enterprise Security

Enterprise security requirements for WPA/WPA2/WPA3 Enterprise now require a CA certificate file to be imported to your unit. Some EAP types also require a client certificate and key. This procedure assumes that you are trying to connect to an AP using WPA2-E with PEAP.

- [Before You Begin](#)
- [Import the Certificate Authority File](#)

- [Test Wi-Fi Management Using WPA2-E with PEAP](#)
- [Import the Client Certificate](#)

Before You Begin

You may depend on your IT department to provide authorization certificates, which may be created by a Trusted Root Authority like VeriSign or DigiCert. If so, contact your IT department for the certificate resources. You will need:

- CA certificate in .pem format
- Clients:certificates in .p12 format with private key (EAP TLS only)
- Common name, domain name, username, and password for the server you to which you want to connect.

If you have the ability to generate your own self-signed certificates, such as a FreeRADIUS server, you can create these resources as needed. This procedure uses examples generated by a FreeRADIUS server as a certificate source, although other sources are available.

Import the Certificate Authority File

1. Copy the self-signed Certificate Authority (CA) file (in .pem format) onto a USB thumb drive.
2. Transfer the USB thumb drive to your EtherScope nXG, and then copy the .pem file to the **Downloads** folder.
3. Open the Settings app.
4. Navigate to **Security > Encryption & credentials > Install a certificate > Wi-Fi certificate**. This opens the file picker.
5. Navigate to the Downloads folder, and select the .pem file that contains your CA certificate.
6. Rename this certificate (for example, **CA FreeRadius self-signed**). A message confirms that the Wi-Fi certificate has been installed.
7. (Optional) Verify the CA certificate installed correctly:

- a. Tap the system **BACK** button to return to Encryption & credentials.
 - b. Tap **User credentials**.
 - c. Verify that the name of your CA file (for example, **CA FreeRadius self-signed**) is displayed.
8. If you are creating your own certificate:

- a. Verify the common name for the enterprise server. For example, using a FreeRADIUS server, create a common name of Example Server Certificate by entering:

```
sudo -s
```

```
cd /etc/freeradius/certs
```

```
openssl x509 -in server.pem  
-text | grep Subject |  
grep CN
```

Output:

```
Subject: C=FR, ST=Radius,  
O=Example Inc., CN=Example  
Server Certificate
```

```
emailAddress=  
admin@example.org
```

- b. On the same server, create a user login to access the enterprise server. For example, with a FreeRADIUS server, you would edit `/etc/freeradius/users`, locate the section for "# The canonical testing user", and then create the new user by inserting 2 lines:

```
entuser1 Cleartext-Password  
:= "randompw"  
Reply-Message := "Hello, %  
{User-Name}"
```

This creates a user login called **entuser1** with a password of **randompw**.

Test Wi-Fi Management Using WPA2-E with PEAP

1. Open the Settings app on your unit and navigate to **Network & internet**.
2. Toggle the Wi-Fi button to On/Enabled.
3. Tap **Wi-Fi** to view available networks.

4. Scroll down to and then select the SSID of the enterprise server you wish to connect to using WPA2-E (for example, **TEST-Ruckus-WPA2-E**).
5. Configure the following WPA2-E options in the pop-up dialog:
 - EAP method: **PEAP**
 - Phase 2 authentication: **MSCHAPV2**
 - CA certificate: (use whatever name you chose for your CA certificate, for example, **CA FreeRadius self-signed**)
 - Online Certificate Status: **Do not validate**
 - Domain: (enter the Common Name recorded above, for example, **Example Server Certificate**)
 - Identity: (enter whatever test user name was set up for the server, for example, **entuser1**)
 - Anonymous identity: (leave blank)

- Password: (enter the password set up for the server)
6. Tap the **CONNECT** button to apply settings and close the configuration page.
 7. Verify that the test SSID appears at the top of the list with a status of Connected.

Import the Client Certificate

NOTE: Applies to EAP TLS only.

1. Obtain a client certificate in .p12 format. Be sure it includes the private key.

NOTE: Although the imported CA certificate is a .pem file, NetAlly recommends a .p12 file format for the client certificate. Below is a sample openssl command to convert a client certificate from .pem to .p12 format:

```
<path_to_openssl_bin>\openssl.exe  
pkcs12 -legacy -provider-path  
<openssl_path>/providers -export  
-inkey <privateKey>.key  
-in <client_cert>.pem  
-out <client_cert>.p12
```



2. Rename the certificate file, for example, **client.p12**.
3. Copy the .p12 file to a USB thumb drive.
4. Transfer the USB thumb drive to your EtherScope nXG, and then copy the .p12 file to the **Downloads** folder.
5. Open the Settings app.
6. Navigate to **Security > Encryption & credentials > Install a certificate > Wi-Fi certificate**. This opens the file picker.
7. Navigate to the **Downloads** folder, and select the .p12 file that contains your client certificate (for example, **client.p12**). A message prompts you to enter the password.
8. Enter the client certificate password to extract the certificate.
9. Rename the certificate, for example, **FreeRadius client**. A message confirms that the Wi-Fi certificate has been installed.

10. (Optional) Verify the client certificate installed correctly:
 - a. Tap the system **BACK** button to return to Encryption & credentials.
 - b. Tap **User credentials**.
 - c. Verify that the name of your client certificate file (for example, **FreeRadius client**) is displayed.
11. Press the system **BACK** button to return to Encryption & credentials. You can now securely connect to your enterprise server.

Sharing

The system **Files**  app lets you share files from internal or external storage to Bluetooth, a printer, or the Link-Live cloud service. You can upload one selected file or multiple files at once.

NOTE: Many apps on your unit allow you to save settings and configuration information directly to Link-Live. See [Saving App Settings and Configurations](#).

1. On the Home Screen, open the Files app by tapping the icon .
2. Navigate to the folder containing the files you want to share using the Navigation menu  or the [left-side navigation drawer](#).
3. Long-press on one or multiple files to select.

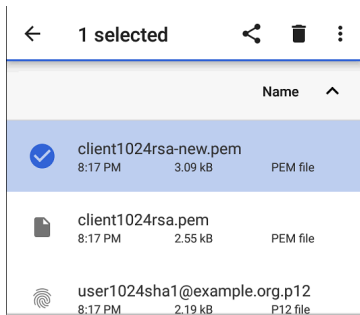

4. Tap the  share icon in the top toolbar to open the Share pop-up dialog.

Share via



Link-Live



Bluetooth

5. Tap to choose a sharing method and follow the system prompts to share the file or files.
6. (Optional) If uploading to [Link-Live](#):

- a. Tap the  **Link-Live** option.

**Link-Live**
by NetAlly



File Name

client1024rsa-new.pem

Comment

Certs

Job Comment

South Campus Wi-Fi

 **SAVE TO LAST TEST RESULT**

 **SAVE TO UPLOADED FILES**

- b. Enter any **Comments** you would like attached to your file.

- c. Select **SAVE TO LAST TEST RESULT** or **SAVE TO UPLOADED FILES**. Your files are then uploaded and viewable on Link-Live.com. (The **SAVE TO LAST TEST RESULT** option attaches the image to your most recently run AutoTest, Performance, iPerf, or Cable Test results on Link-Live.com.)
- d. See the [Link-Live](#) chapter for more information on using Link-Live with your EtherScope nXG.

Sharing a Screenshot

To take and share a screenshot:



1. Press and hold the **Power** button and the **Volume Down** button at the same time for one second. (See [Buttons and Ports](#) for button locations). The unit beeps and adds a notice to the [Notification Panel](#).
2. Access the file either by opening the Notification Panel and tapping the screenshot notice or by using the Files app.

3. Follow the [Sharing procedure](#) to share the image using Link-Live, Bluetooth, or another configured application.

Changing the Device Language

The EtherScope nXG supports Chinese, English, German, Japanese, and Korean language displays.

To change the device's interface language:

1. Go to the [Device Settings](#) screen by tapping the Settings  icon at the bottom of the Home screen.
2. Scroll to and select **System**.
3. Select **Languages & input** and then **Languages**. This displays the Language preferences screen.
4. On the Language preferences screen, select **+ Add a language**.
5. Tap the language option you want. This returns you to the Language preferences screen.
6. Touch and hold the icon  to the right of the language, and then drag the language to

the top (number 1) place on the list.



The EtherScope displays the chosen languages, as available, in the priority order shown on the Language preferences screen.



NOTE: This user guide supports Chinese and English. If you choose German, Japanese, or Korean as the device language, the system uses the English user guide. See [How to Use this Guide](#) for more information about the user guide.

NOTE: Manuals are also available for web download at: <https://www.net-ally.com/support/user-guides/>

EtherScope nXG Settings and Tools

The EtherScope nXG features a common set of tools and **General Settings** that apply to multiple NetAlly apps and testing behaviors. This chapter covers settings, icons, and notifications *specific to EtherScope nXG*.

(See the **Device Settings** topic for information on the system settings.)

Access common settings and informational screens for the NetAlly testing apps (like AutoTest or Capture) by opening the left-side Navigation Drawers  or Settings .

Navigation Drawer

Many system apps, including the NetAlly test apps, contain additional settings, tools, and information in a "navigation drawer" that slides out from the left side of the screen.

To open the navigation drawer:

- Tap the menu icon  at the top left of one of the testing application screens.
- Touch and drag (swipe) to the right from the very left side of the app screens.

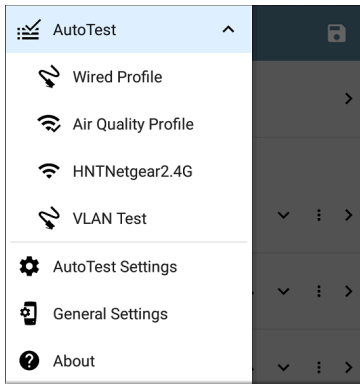

As an example, the AutoTest navigation drawer (above) provides access to the enabled [AutoTest profiles](#), AutoTest Settings, [General Settings](#), and the About screen.

Settings for each specific app are described in the chapter for the app.

About Screen

**About**

EtherScope nXG Analyzer

Model: EXG-300

Serial: 2043034ESNXG

MAC Addresses

Wired: 00c017-5313e8

Wired Management: 00c017-5313e9

Wi-Fi: 00c017-5313ea

Wi-Fi Management: 00c017-5313eb

Versions

System: 2.5.0.153

AllyCare: Enabled

Expires: 6/24/2024

SFP Details

Type: 10GBASE-SR (850 nm)

Vendor: AVAGO

Version: G2.3

Model: AFBR-703SDZ

Rx Power: --

[EXPORT LOGS](#)

The About screen displays the model number, serial number, MAC addresses, software versions, SFP details, and current AllyCare contract status for your EtherScope nXG.

You can enable a **User-Defined MAC** in the application [General Settings](#), in the [Wired](#) profile settings, or in the [Wi-Fi](#) profile settings. (**User-defined**) then appears next to the MAC address on the About screen and in relevant test screens.

Exporting Logs

The About screen contains the Export Logs function, which allows you to save your unit's logs for analysis by NetAlly's technical support team.

Tap the **EXPORT LOGS** link to download a .tgz file to the Downloads folder on your unit. Open the [Files](#) app to transfer the file using email or another method. (See [Managing Files](#).)

Import/Export for All Apps

Tap the action overflow icon  on the About Screen to display a menu for importing or exporting of settings for *all* applications that allow import/export. See [Import/Export Settings](#) for details.

Restarting the Test Unit

To restart your test unit, tap the action overflow icon  on the About Screen and select the **Restart Tester** option.) (This functions the same as holding down the power button and then tapping the **Restart Tester** option.)

Test and Management Ports

The EtherScope nXG has two wired RJ-45 copper ports, a fiber port, and two Wi-Fi radios, each with specific test or management functions described in this section.

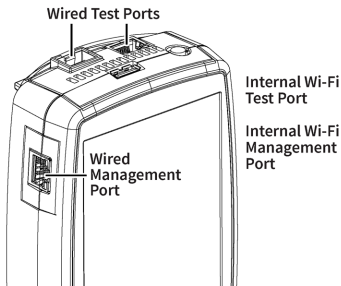

Either the top copper port or fiber port can act as the Wired Test Port, so in total, the EtherScope has *four* network interfaces: 1) Wired Test, 2) Wi-Fi Test, 3) Wired Management, and 4) Wi-Fi Management. The Wi-Fi test radio is controlled by in general settings in NetAlly applications such as AutoTest and

AirMapper. The Wi-Fi management radio is set up by system network settings. See [Selecting Ports](#) below for more information.

See the sections below for more information on the ports. Also see [Buttons and Ports](#) and the technical [Specifications](#) as needed.

Test Ports



Wired Copper Test Port: The copper test port is the RJ-45 port on the top of the unit. To disable, unplug the connection.



Wired Fiber Test Port: The SFP and fiber test port is also on the top of the unit. To disable, unplug the connection.



Wi-Fi Test Port: The internal Wi-Fi test adapter is a 4x4 Dual-band 802.11ac wireless radio. To disable, see [General Settings](#) in the testing apps' left-side [navigation drawer](#).

NOTE: If both the top fiber and copper ports are connected to an active network, the EtherScope uses the fiber link as the Wired Test Port connection.

EtherScope nXG runs Wired and Wi-Fi AutoTests, Captures, Discovery, and other comprehensive network analysis apps over the test ports. The Wi-Fi test radio is primarily controlled by the settings in applications, especially AutoTest.

You must also run an AutoTest Wired or Wi-Fi Profile to establish a link on the Wired or Wi-Fi test ports. If the AutoTest app is not currently open, the last Wired Profile in the profile list runs automatically when you power on the unit or EtherScope detects a new copper link in the top [Wired Test Port](#). Wired fiber connections and Wi-Fi Profiles must be started manually in the [AutoTest](#) app.

Note that the [General Settings](#) affect how you can use the test port. (The General Settings are accessible from the left-side [navigation drawer](#) from most NetAlly testing apps.)

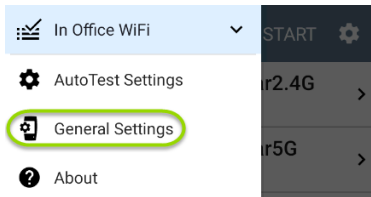

The **Use Wi-Fi test port** option must be enabled for the test ports to function. (Enabled is the default setting.)

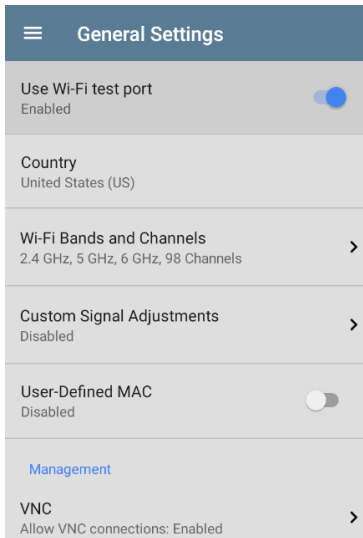

NetAlly also recommends that you enable all Wi-Fi Bands and Channels before setting up Wi-Fi Test Profiles:

1. Tap the **Wi-Fi Bands and Channels** option to open the Wi-Fi Bands and Channels screen.

2. Tap the Wi-Fi band(s) option to open a selection screen, and then enable all available bands.
3. Tap the option for each frequency band to open a selection screen, and then enable all available channels for each band.

This process makes it easier to set up the Wi-Fi Test Profiles, which you can limit to specific channels, APs, SSIDs, etc. See [AutoTest Wi-Fi Profile](#) for more information.

See [General Settings](#) for more information about all General Settings options.

Management Ports

 **Wi-Fi Management Port:** The internal Wi-Fi management port runs on the main system's 1x1 Dual-band 802.11ac + Bluetooth 5.0 wireless adapter, which is configured in the system Device Settings. See [Connecting to Wi-Fi](#) to configure this connection.

The Wi-Fi management radio is set up by the system network settings. The radio provides full Internet access and a more stable network

connection than the Test Ports, which may frequently drop links and reconnect or resume scanning.

EtherScope can run Discovery, Ping/TCP Connect tests, Path Analysis, and iPerf tests on the management ports, but not AutoTests, packet captures, or Performance tests.

 **Wired Management Port:** The wired management port is the RJ-45 port on the left side of the unit.

Selecting Ports

Some of the individual NetAlly testing apps let you select which port interface to use for tests or analysis.

- You may want to verify that you are getting a reliable connection to the Internet and the Link-Live cloud service while you are actively using the Wi-Fi Test port to perform an AirMapper survey. To check connectivity, you can configure the Ping/TCP app to use the Wi-Fi Management port to run a continuous background ping to the Internet.

- Each port can connect to different networks. For example, an organization might have one network for visitors and another for staff. You can use multiple ports to check connectivity on each network without the need to link and relink through a single interface.

To change the port, tap an app's settings icon  to display the settings screen. Then tap **Interface** to select the port from a dialog.

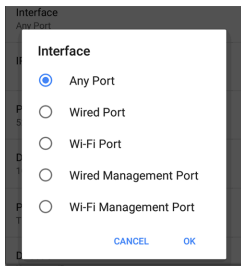

- The top two Wired and Wi-Fi Ports refer to the Test ports.
- An AutoTest [Wired](#) or [Wi-Fi Profile](#) must run to establish test port links.

- The last listed [Wired Profile](#) runs automatically when you start up the EtherScope if a connection is available.

Test and Port Status Notifications

EtherScope nXG shows notifications from the NetAlly testing apps and unit ports in the top Status Bar and [Notification Panel](#). Swipe down on the Status Bar to view the notifications.

On each notification, you can tap the title and down arrow to expand the box and view more details or options.

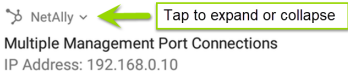

Various EtherScope icons appear in your Status Bar, as listed in the following sections.

NOTE: Read [Test and Management Ports](#) for descriptions of the port functions.

See [General Settings](#) for settings that control port functions.



Test Port Notifications

Active network connections on the test ports are established using the [AutoTest](#) app.

 You can set up a **Wired Test Port** connection (called the "Wired Port" in app settings) for either the top RJ-45 Ethernet [port](#) or the top Fiber port by running an Auto Test Wired profile.

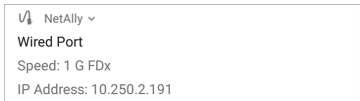
NOTE: If both the fiber and top copper ports are connected to an active network, the EtherScope uses the fiber link as the "Wired Port" for testing.



 or  The **Wi-Fi Test Port** status displays with the wireless channel number under a Wi-Fi or Link icon. Channels in the 6 GHz band (EXG-300/300E only) display with an E by the Wi-Fi or Link icon.



When the EtherScope unit is dwelling on a Wi-Fi channel (in this case channel 64), the channel number is static. When the EtherScope is scanning for discovery, Wi-Fi analysis, or air quality measurements, the channel number changes dynamically to show which channel is currently being scanned.

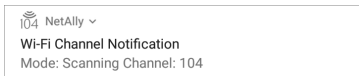

When the EtherScope unit connects to an AP on a Wi-Fi channel, the channel number is static, and the Link icon displays above it. If the link is dropped, the channel number changes to an X.



(EXG-200 only) Active scanning while the EtherScope unit is in all-channel-scanning mode.

 132 NetAlly ^
Wi-Fi linked on channel 132
 SSID: NSVisitor
 Signal: -58 dBm
 Channel Width: 20 MHz
 IP Address: 192.65.49.107



Periodic AutoTest is running or has completed. When **Periodic AutoTest** is running, the Wired and/or Wi-Fi Test Ports may not be available to other testing apps.

 AutoTest ^
Periodic AutoTest Running
 Passed: 3
 Failed: 2
 Skipped: 1
 Time Remaining: 54 m

Management Port Notifications



You can establish a **Management Port** connection through the left-side RJ-45 Management port and/or an optional USB-to-Wi-Fi adapter.

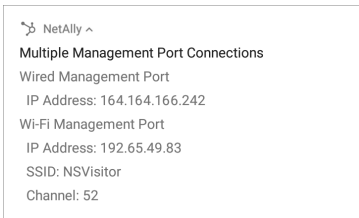

A **Wired Management Port** connection is established through the left-side RJ-45 Management **port**. Its details are displayed under the Management Port notification (above).



A **Wi-Fi Management Port** connection can be established via the main system Wi-Fi adapter. Its details are displayed under the Management Port notifications.

If your Management connection is lost, the following notification displays.



Discovery Notifications

The Discovery notifications show the progress of the discovery process. See the [Discovery](#) app chapter for more information.

 The active discovery process is running and has progressed to the specified percentage.

 No links are currently available for active discovery, either because none of the ports enabled for discovery are connected or AutoTest is running. Discovery is temporarily disabled when AutoTest is running.

PoE

 Indicates that your unit is connected to a Power over Ethernet source. See [PoE Charging](#) for more information.

VNC/Link-Live Remote

 A remote VNC connection is active through a standalone VNC client and/or the Remote function in [Link-Live Cloud Service](#).

 NetAlly ^

Remote Connected

Clients

172.24.0.219

Link-Live Remote: Angela Tech Writer

EtherScope nXG General Settings

EtherScope's General Settings control test and management-related connections that affect multiple test apps.

Access the General Settings from the [left-side navigation drawer](#)  in the NetAlly testing apps, such as AutoTest, Discovery, Capture, iPerf, etc.

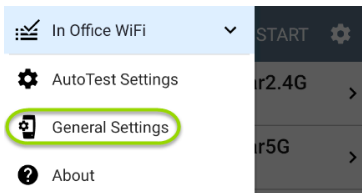

See also [Test and Management Ports](#) and [Test and Port Status Notifications](#) for related information on port functionality and status icons.

6 **Wi-Fi General Settings** 1

The Wi-Fi General Settings control functions of the [Wi-Fi Test Port](#) functions.

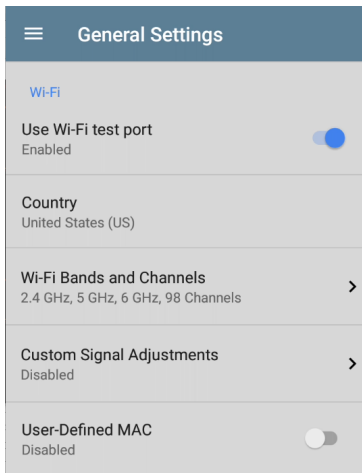

Use Wi-Fi test port: Enable or disable Wi-Fi tests, connections, and measurements in the testing

apps, including [AutoTest Wi-Fi Profiles](#) and the [Wi-Fi](#) analysis app.

NOTE: This setting does not disable the main system device Wi-Fi function, which controls the Wi-Fi Management port connection. See [Device Settings](#) to disable the system Wi-Fi.

Country: Set the country code for your unit. This setting controls which channels can be scanned and which channels are reported as illegal or which may have Dynamic Frequency Selection (DFS).

Wi-Fi Bands and Channels: Select the wireless frequency bands and channels the unit scans for devices and measurements such as utilization.

Tap each band or channel setting to open a selection dialog.

- Unchecking a Wi-Fi Band prevents any linking to, or scanning of, channels in that band.
- Unchecking a Channel means the channel still links but does not get scanned.

- Channel changes affect these apps: Air Quality scans, Wi-Fi results (scanning), Discovery, AirMapper (passive surveys)
- Channel changes do *not* affect these apps: AutoTest results (linking), Wi-Fi Capture, AirMapper (active surveys)
- Tap the **Dwell Time** field to adjust the amount of time the EtherScope stays on each channel to gather data.

☰ Wi-Fi Bands and Channels	
Wi-Fi Band(s)	2.4 GHz, 5 GHz, 6 GHz
2.4 GHz Channels	All
5 GHz Channels	All
6 GHz Channels	All
Dwell Time	210 ms

Custom Signal Adjustments: Tap this setting and then tap the **Signal Adjustments** toggle to open an adjustment panel for each frequency band. You can adjust the signal strength for each band from -20 dB to +20 dB.

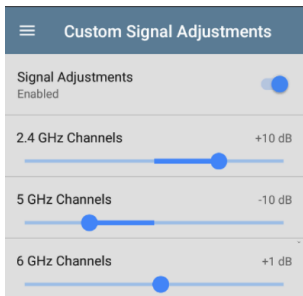

Combine Utilization: (EXG-200 only) Enable this setting to combine 802.11 and non-802.11 channel utilization into one total utilization measurement. In environments with 802.11ax traffic, turn this setting on to accurately measure channel utilization. When this setting is enabled, EtherScope app screens that typically show both 802.11 and non-802.11 utilization (such as the

[Wi-Fi Channels Map](#)) now show the total utilization.

User-Defined MAC: This setting affects the [Wi-Fi Test Port](#) only.

1. Tap the toggle field to enable a user-defined MAC for the EtherScope. This displays the current user-defined MAC definition. (If you have not previously provided a definition, the field shows the factory default MAC address.)



2. To enter a new definition, tap the User-Defined MAC definition field, enter a new definition, and then tap **OK**. When enabled, **(User-defined)** appears next to the MAC address on the [About](#) screen and on relevant test result screens.

NOTE: This definition can be overridden by a profile-based user-defined MAC. See [Wi-Fi Profile Settings](#) for more information.



Wired General Settings

Wired General Settings control functions of the [Wired Test Port](#).

Wired	
Use Wired test port Enabled	<input checked="" type="checkbox"/>
Test PoE before link Enabled	<input checked="" type="checkbox"/>
Charge battery via PoE Enabled	<input checked="" type="checkbox"/>
Receive Only Disabled	<input type="checkbox"/>
User-Defined MAC Disabled	<input type="checkbox"/>

Use Wired test port: Enable or disable wired tests, connections, and measurements in the testing apps, including [AutoTest Wired Profiles](#).

NOTE: the tester reboots when you leave the General Settings screen after you toggle this option. (This changes the powered state of the wired test port.)

Test PoE before Link: By default, an AutoTest [Wired Profile](#) performs the Link test before the PoE test can complete. Enable this setting to make your EtherScope complete the PoE test before the Link test. Enabling this setting forces PoE negotiation to be completed before establishing link, improving compatibility with some switches.

Charge Battery via PoE: (Available if supported by tester hardware.) This setting is enabled by default. If you do *not* want your CyberScope unit to charge when connected to a switch with PoE, tap the toggle button to disable. An AutoTest [Wired Profile](#) must run and detect PoE availability before the unit can use it for charging.

See also [PoE Charging](#).

Receive Only: Enable this setting to prevent the EtherScope from transmitting packets on the [Wired Test Port](#). You can also use the **Stop After**

function in [Wired AutoTest Profile Settings](#) to hide the AutoTest cards that require transmit capability. Set the AutoTest **Stop After** setting to **Switch**. Otherwise, when **Receive Only** is enabled, the Wired DHCP/Static IP test shows a Result Code of "Interface is configured to only receive packets," and the subsequent tests do not run.

User-Defined MAC: This setting affects the [Wired Test Port](#) only.

1. Tap the toggle field to enable a user-defined MAC for the EtherScope. This displays the current user-defined MAC definition. (If you have not previously provided a definition, the field shows the factory default MAC address.)



- To enter a new definition, tap the User-Defined MAC definition field, enter a new definition, and then tap **OK**. When enabled, **(User-defined)** appears next to the MAC address on the [About](#) screen and on relevant test result screens.

NOTE: This definition can be overridden by a profile-based user-defined MAC. See [Wired Connection Settings](#) for more information.

Management

These settings affect management-related functions on the EtherScope, including remote access.

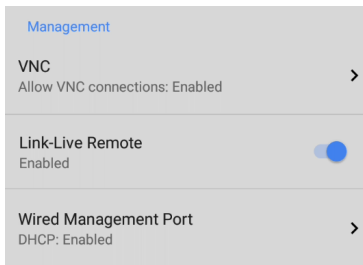

The screenshot shows a settings menu with a grey background. At the top, the word "Management" is written in blue. Below it are three settings items, each with a right-pointing chevron:

- VNC**: Allow VNC connections: Enabled
- Link-Live Remote**: Enabled (with a blue toggle switch)
- Wired Management Port**: DHCP: Enabled



Tap **VNC** to open the VNC settings screen and configure your unit's VNC connections for remote operation.

See [Using VNC](#) for more information about connecting to a VNC client or Link-Live Remote.

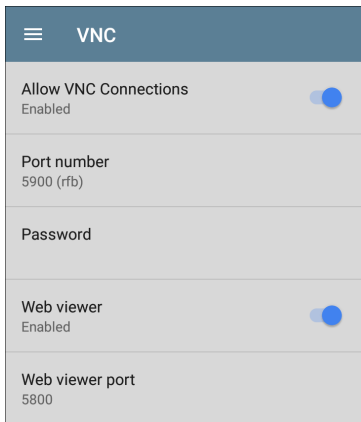

Allow VNC Connections: (Disabled by default.) Tap the toggle button to enable remote

connections from VNC clients and display VNC options.

Port number: Tap to enter a port number other than the default.

Password: Tap to enter a password, which a VNC user must enter to access the EtherScope interface remotely.

NOTE: If you set a **Password** here in the **VNC** settings, the password is required to connect to both a standalone VNC client and the Remote feature at Link-Live.com.

Web viewer: Tap the toggle to enable or disable web viewer access.

Web viewer port: Tap to enter a port number other than the default.

Link-Live Remote

This setting enables or disables the EtherScope's remote control function in [Link-Live Cloud Service](#) at [Link-Live.com](#).

NOTE: The Link-Live Remote feature is only available to customers with an active **AllyCare** subscription. Your EtherScope must

be [claimed](#). See NetAlly.com/Support for more information.

Access the Remote function on the **Units**  page at Link-Live.com by selecting the claimed EtherScope nXG.

Wired Management Port

DHCP: This setting controls IP address assignment of the [RJ-45 Wired Management Port](#) on the left side of the EtherScope. By default, DHCP is enabled. Tap this field and tap the toggle button to disable DHCP and enter static IP information.

Preferences

Preferences

Distance Unit

Feet

Distance Unit: This is the unit EtherScope uses for distance measurements in the testing apps, specifically [AirMapper](#) and [Cable Test](#).. Tap the field to switch between Feet and Meters.

Save Locally Only: Tap this toggle field to change the unit default behavior for saving files. (The default is to give you the option to save to [Link-Live](#) or locally.)

Trending Graphs

Many of the EtherScope nXG testing apps feature time-based line graphs of recorded measurements, which you can pan and zoom to view different time intervals. For example, the image below shows the Signal and Utilization graphs from the [AutoTest Wi-Fi Link Screen](#).

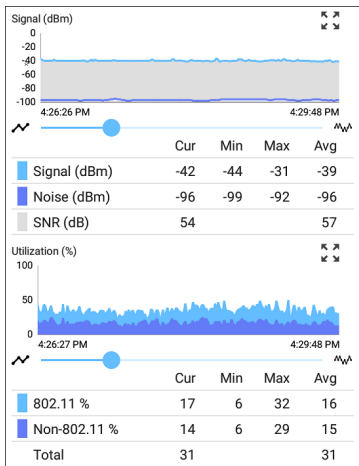



d

The graphs update in real time and then save and display data for up to 24 hours (depending on test type and/or link status).

A legend indicates the measurements that correspond to each plotted color.

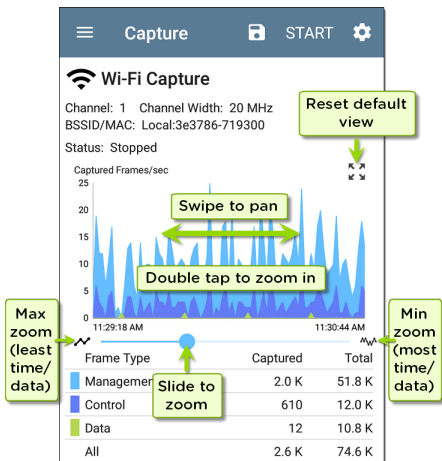
For another example, the image below shows the **Capture** app graph.



- To pan, or move backward and forward in time, touch and drag (swipe) left and right on each graph.
- To zoom in on a specific point, double tap the point on the graph. The view zooms in 2x (or displays half the amount of time) for each double tap.
- To zoom in or out, decreasing or increasing the time interval displayed, drag the slider or tap the slider bar below the graphs.
 - The largest time interval (maximum zoom out) is the total time data has accumulated.
- To reset the graph to the default time interval, tap the zoom reset icon .
- The zoom reset icon appears *after* you zoom or pan on the graph.
- The default time interval varies across different apps.

The following apps and screens contain trending graphs:

- [AutoTest Wi-Fi Profiles – Link and Channel](#)
- [Ping/TCP – Ping Test](#)

- Capture
- Discovery – Interface Statistics
- Wi-Fi – RF and Traffic Statistics
- Performance
- iPerf

Common Icons

The icons below appear in multiple NetAlly test and system apps.



Menu Icon - opens the left [navigation drawer](#) or other menus



Refresh Icon - restarts testing and measuring on the current screen



Settings Icon - opens configuration options for the current app



Save Icon - saves settings or files or loads saved configurations



Floating Action Button (FAB) - opens the Floating Action Menu, which contains additional actions



Action Overflow Icon - contains additional actions



Directional Arrows (or Carets) - indicate the ability to "drill in," open a screen, or expand a panel for more detailed information, or to change the order of a list

For explanations of the EtherScope icons that appear in the Status Bar at the top of the screen, see [Test and Port Status Notifications](#).

Floating Action Button (FAB) and Menu

Many system applications, including NetAlly's AutoTest and Discovery apps, feature a Floating Action Button or "FAB"  that opens a floating action menu with more options for analysis.

The FAB on the main AutoTest app screen allows you to add new testing Profiles.

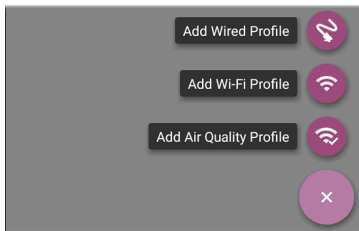

The FAB on the Discovery app's Details screen opens other apps for further testing of the selected device.

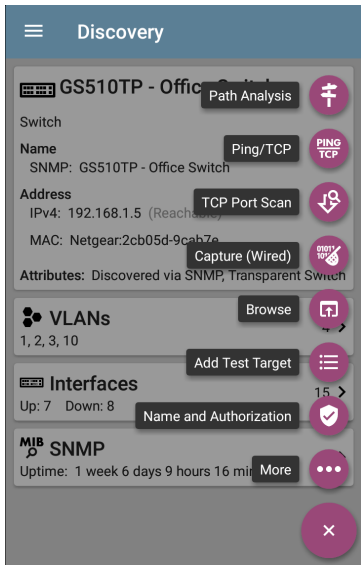

See the chapter for each app for descriptions of the FABs specific to that app. For example, see [Discovery App Floating Action Menu](#) describes the Discovery FAB in more detail.

Common Tools

Web Browser/Chromium

Some of the testing apps, like AutoTest, Ping/TCP, and Discovery, give you the option to **Browse** to internet addresses using a web browser application. EtherScope has the Chromium browser pre-installed.

Telnet/SSH

The JuiceSSH  application pre-installed. Both the AutoTest and Discovery apps provide links to start a Telnet or SSH session using the current device address. Selecting these options opens JuiceSSH and starts a session. You can also open JuiceSSH from the [Apps](#) screen.

The JuiceSSH app maintains a list of previous connections. When opened from a NetAlly app, JuiceSSH uses the first connection in the list that matches the IPv4 address or device name and type. If no match is found, a new connection entry is created and used.

As a third-party app, JuiceSSH contains its own tutorials. For additional help, tap the action

overflow button  at the top right of the JuiceSSH app screen, and select **View our FAQ**.

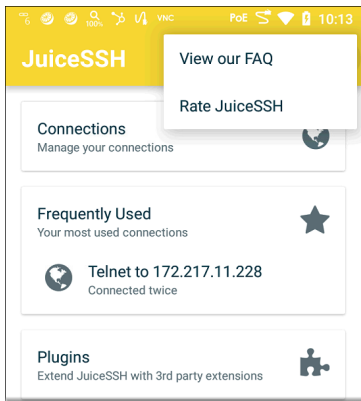

Camera and Flashlight

The camera lens and flash are located on the back of the unit. (See [Buttons and Ports](#).)

The Camera application  is located in the Apps screen and on the Home screen by default. Tap the icon to open the camera app and take a photo, which you can then [share](#) to other applications.

Additionally, once a Wired or Wireless [AutoTest Profile](#) has completed, the [floating action button](#) appears and provides the option of opening the camera application to take and attach a picture to the AutoTest result uploaded to [Link-Live Cloud Service](#).

Flashlight

The flashlight is located on the back of the unit. (See [Buttons and Ports](#).)

Access the Flashlight feature from the [Quick Settings Panel](#) by swiping down twice from the top of the screen.

Software Management

This chapter explains how to save and transfer files, reset app and device defaults, update your software, and remotely access your EtherScope nXG.

Tap a link below to skip to a topic:

[Managing Files](#)

[Updating Software](#)

[Remote Access](#)

[Resetting App Defaults](#)

[Restoring Factory Defaults](#)

Managing Files

The EtherScope nXG operating system, images, documents, and other files reside in a folder system, where you can copy, move, and paste them between folders or to external storage locations.

See also [Sharing](#).

Files Application

The Files app allows you to access the files saved on your EtherScope. Tap the  icon at the bottom of the Home Screen (or from the [Apps](#) screen) to manage your files.

NOTE: To select the device sub-folders in the Files app as shown below, you may need to open the [navigation drawer](#) by swiping from the left side of the screen or by tapping the navigation icon  at the top left and then tapping the **EtherScope-nXG** folder.

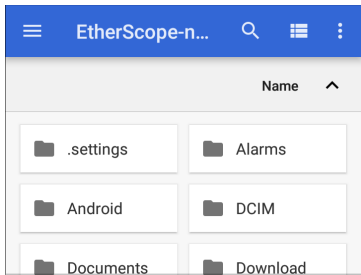

- Tap a folder or file to open it.
- **Long press** on folders or files to select multiple and to view additional file management operations in the top toolbar, including the **Share**  and Delete buttons.



- Tap the action overflow icon  to see even more actions, such as to create a new folder, move a file, delete an item, and to show or hide the main internal storage folder.

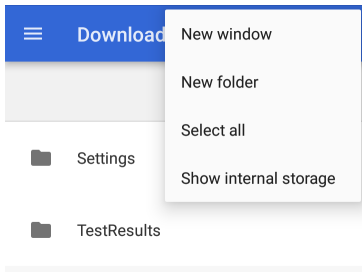

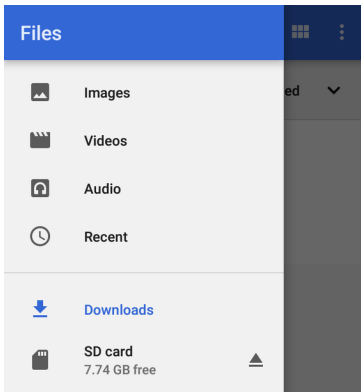

- Open the left-side [navigation drawer](#)  to easily navigate through the top-level folders and attached storage devices.

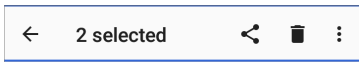

How to Move or Copy a File

1. Long press on a file to select it. You can then select more files as needed by tapping them.



2. Tap the overflow icon  at the top right.
3. Select **Copy to...** or **Move to....** Your selected action button appears at the bottom of the

screen.

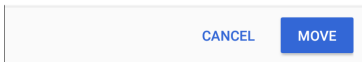

4. Navigate to the folder where you want to move or copy the file.
5. Tap the **Move** or **Copy** button at the bottom of the screen.

Using a Micro SD Card

To use a Micro SD card for storage, insert it into the [Micro SD card slot](#) on the left side of your EtherScope nXG. See [Inserting a Micro SD card](#).

A Micro SD card icon  appears in the Status Bar at the top of the screen. Pull down the top [Notification Panel](#) to reveal the SD card notification.

 Tester System ▾

SD card

For transferring photos and media

Tap the notification title or down arrow to expand the notification and display additional options:

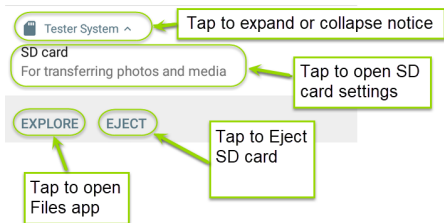

The **SD card** storage location is also available from the [Files](#)  application.

⚠ CAUTION: Use the system **EJECT** function before physically removing your Micro SD card from the USB port to avoid potential corruption of your storage device's file system.

Using a USB Drive

Insert a USB flash drive into the [USB port](#) on the top of the EtherScope.

A USB icon  appears in the Status Bar at the top of the screen. Pull down the top **Notification Panel** to reveal the USB drive notification.

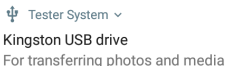

Tap the notification title or down arrow to expand the notification and display additional options:

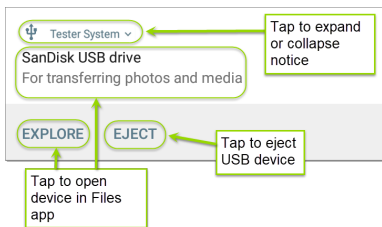

The **USB storage** location is now available from the **Files**  application.

⚠ CAUTION: Use the system **EJECT** function before physically removing your USB drive from

the USB port to avoid potential corruption of your storage device's file system.

Ejecting Storage Media

You can eject storage media from the expanded system notification (as shown above) in the Notification Panel or from the left-side [navigation drawer](#) in the Files app (below).

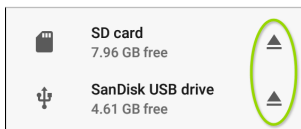

Using a USB Type-C to USB Cable

1. Plug a USB-C cable into the [USB-C](#) port on the left side of the EtherScope, and connect to a PC or tablet.
2. On the EtherScope Unit, open the system device settings by tapping the Settings  icon at the bottom of the [Home screen](#).
3. Select **Connected devices**.

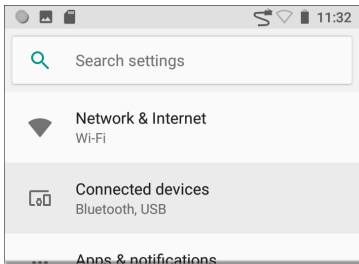

4. On the Connected devices screen, select **USB**.
5. In the pop-up dialog, tap **Transfer files** to enable file transfer.

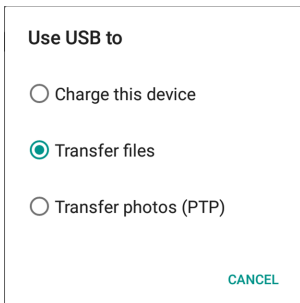

NOTE: EtherScope does not charge through a USB cable connected to a PC.

6. On a PC or tablet, navigate to the EtherScope nXG folder, and then move, copy, and paste files to and from the EtherScope nXG's file system.

 **CAUTION:** Use the system **EJECT** function before physically disconnecting the USB cable from your PC or EtherScope to avoid potential corruption of your storage device's file system. See [Ejecting Storage Media](#) above.

Updating Software

Your EtherScope nXG accesses software updates from the Link-Live Cloud Service "Over-the-Air" (OTA). However, you can also manually download and install updates if you do not want to claim your unit to Link-Live. See [Manual Updates](#) below.

Over-the-Air Updates



For an OTA update, you must create an account and "claim" your EtherScope nXG unit at [Link-Live.com](https://link-live.com). Then your EtherScope can find and download software updates. See [Getting Started in Link-Live](#).

The first time you claim your EtherScope nXG to Link-Live, a software update may be available. If so, an update icon  appears in the Status Bar. Slide down the [Top Notification Panel](#), and then select the notification to update your unit.

 Link-Live

Software Update Notification

Software update available.

1. To check for available software updates at any time, open the [Link-Live App](#)  from the [Home screen](#).
2. In the Link-Live App, tap the menu icon  or swipe right to open the left-side [navigation drawer](#).

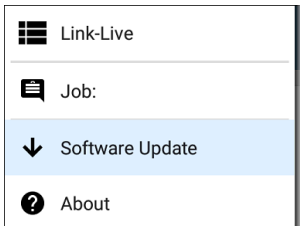

3. Tap **Software Update**. The Software Update screen opens and displays the version number of any available updates.

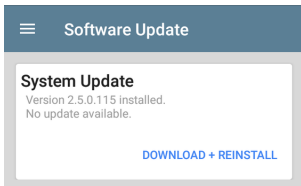

4. Tap **Download + Install** (or **Download + Reinstall**) to update the operating system and NetAlly applications. The update downloads and installs automatically. When finished, the unit restarts.
5. After updating, check the Software Update screen again in case another update is still required.

Manual Updates

You can get update files by contacting NetAlly's Technical Support at NetAlly.com/Support or by downloading them from Link-Live.com as follows:

1. Log in to the Link-Live web site.
2. Open the left-side [navigation drawer](#) by clicking the menu icon , and then select **Support > Software Downloads**.
3. Locate and select the update file for your unit. The file name is in the format: **<product name abbreviation>-ota-user.zip**.
4. Save the update file to a PC.

Updating the System Software

Reference [Buttons and Ports](#) if needed.

1. From your PC, copy the .zip file to a Micro SD card or a FAT32-formatted Type A **USB drive**, and then insert the card or drive into your EtherScope.
2. Power off your EtherScope unit.
3. Press and hold the **Volume Up** button, and then press the **Power** button. Continue to hold the **Volume Up** button until the Recovery screen appears. (You can release the **Volume Up** button a few seconds after

this screen appears.)

4. In Recovery Mode, use the volume buttons to highlight **apply update from SD card** or **apply update from USB drive**.
5. Press the **Power** button to confirm the selection.
6. Use the volume buttons to highlight the correct update file on the Micro SD card or USB drive.
7. Press the **Power** button to confirm. The EtherScope opens the Updater, installs the update, and then restarts with the update installed. This process can take 5 to 10 minutes. When complete, the message 'Install from Micro SD card completed with status 0.' or 'Install from USB drive completed with status 0.' should show on the install line.
8. Use the volume keys and **Power** button to select **reboot system now**. Your unit should boot normally.

Remote Access

EtherScope supports remote access and control using either a standalone VNC client or the Link-Live Remote feature, which uses a VNC client through the Link-Live website.

NOTE: The Link-Live Remote feature is only available to customers with an active **AllyCare** subscription. Your EtherScope must be **claimed**. See [NetAlly.com/Support](https://www.netally.com/support) for more information.

You can establish remote connections using the Wired or Wi-Fi Test Ports. However, the Management Ports provide more stable links for remote control because the test ports may disconnect and reconnect frequently.

See [Test and Management Ports](#).

The top [notifications](#) are the quickest way to find assigned IP addresses for your EtherScope ports. Swipe down from the [Status Bar](#) to view them.

 NetAlly ^**Multiple Management Port Connections**

Wired Management Port

IP Address: 164.164.166.242

Wi-Fi Management Port

IP Address: 192.65.49.83

SSID: NSVisitor

Channel: 52

For a wired management connection, you must have an Ethernet cable with an active network connection plugged into the left-side RJ-45 [Management Port](#).

For a Wi-Fi Management Port connection, you must have the main [System Wi-Fi settings](#) configured to connect to a wireless network.

When a remote session is active, the remote icon  appears in the top Status bar, along with a notification.

 NetAlly ^**Remote Connected**

Clients

172.24.0.219

Link-Live Remote: Angela Tech Writer

Using VNC

Remotely access the EtherScope nXG using a peer-to-peer VNC client installed on a PC or other machine.

See [General Settings > VNC](#) to enable and configure VNC connections.

To connect to EtherScope using a VNC client:



1. Get the IP address of a connected port (preferably a management port) by swiping down from the Status Bar at the top of the screen to view the [notification panel](#).
2. Provide the Wired or Wi-Fi Test or Management Port's IP address to your chosen VNC client application.
3. Connect using your VNC client.
4. If needed, enter the password that is set in the [VNC settings](#).

Using Link-Live Remote

The Link-Live Remote feature uses end-to-end encryption, allowing secure remote control of your EtherScope.

On your EtherScope, go to [General Settings > Link-Live Remote](#) to ensure the feature is enabled.

NOTE: If a Password is enabled in the [VNC General Settings](#), you must also enter the same password to access the Remote feature in Link-Live.

1. If you have AllyCare, sign in to [Link-Live.com](https://link-live.com) to access the Link-Live Remote feature. Your EtherScope must be [claimed](#).
2. Navigate to the **Units**  page at Link-Live.com.
3. Select the EtherScope you want to remote control from the list of claimed units.
4. Click or tap the **REMOTE** icon  at the top right of the page to open an embedded window containing the EtherScope interface.
5. If necessary, at the top of the window, enter the Password set in [General Settings > Management > VNC](#) on the EtherScope unit.

To use the Link-Live website while your remote session is active, you must open a new Link-Live tab or window.

Managing NetAlly App Settings

This topic explains how to reset, [load](#), [save](#), [import](#), and [export](#) the test settings for NetAlly testing apps.

For instructions on restoring factory defaults to the entire test unit, see [Restoring EtherScope nXG Factory Defaults](#).

Resetting Testing App Defaults

After you adjust settings in the NetAlly apps, you may need to reset an app's settings to the defaults. The following process resets all app-specific settings to the factory defaults.

 **CAUTION:** This operation deletes all saved settings, including testing profiles and other application data.

The Discovery app is used as an example in the following steps:

1. Access the **App Info** screen by long pressing (touch and hold) on an app's icon on the

Home or Apps screen.

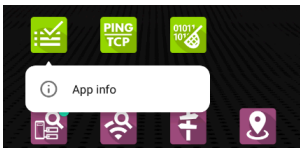

2. Tap App info.

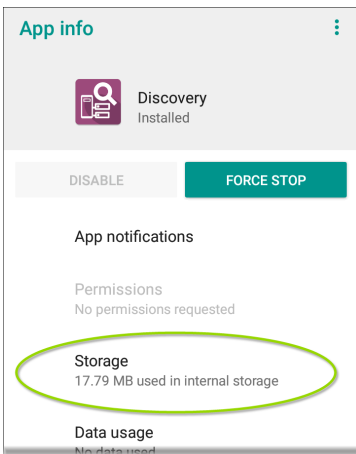

3. On the App info screen, select **Storage**.
(You can also access the App Storage screen from [Device Settings](#)  > **Storage** > **Internal shared storage** > **Other apps**.)
4. On the Storage screen for the app you selected, tap **CLEAR DATA**.

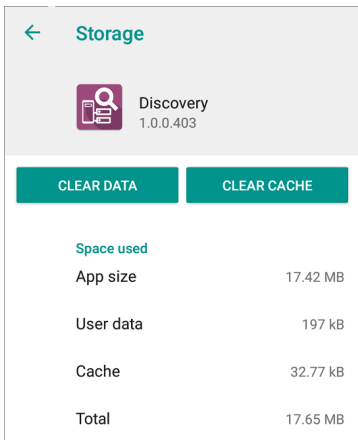

← **Storage**

 **Discovery**
1.0.0.403

CLEAR DATA **CLEAR CACHE**

Space used

App size	17.42 MB
User data	197 kB
Cache	32.77 kB
Total	17.65 MB

5. When a dialog prompts you to delete the data, tap **OK**.

All of the app's settings are reset to factory defaults.

Saving App Settings and Configurations

Many of the NetAlly testing applications allow you to save and reload configured settings by selecting the save button  that appears at the top right within the app's main screen.

The following apps allow you to save and load settings configurations:

- [AutoTest, including Profile Groups](#)
- [Discovery](#)
- [Discovery Problem Settings](#)
- [Performance](#)
- [iPerf](#)
- [Spectrum](#)

The iPerf app is shown below as an example.

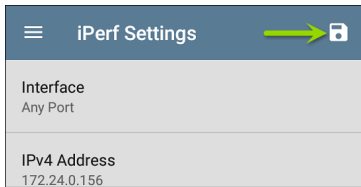

The following options display in a drop-down menu:

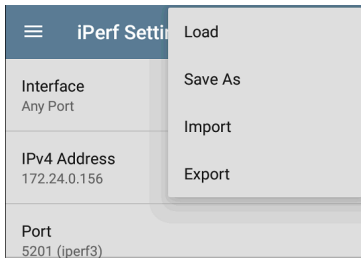

- **Load:** Open a previously saved and named settings configuration.

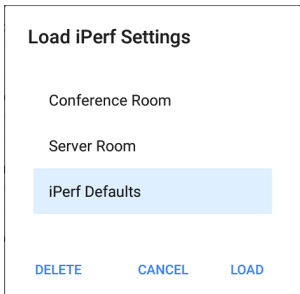

- **Save As:** Save the current settings with an existing name, or enter a new custom name.

Save iPerf Settings

Conference Room

Server Room

iPerf Defaults

Server Room



CANCEL SAVE

- **Import:** Import a previously exported settings file.
- **Export:** Create an export file of the current settings, and save it to internal or connected external storage.
- **Export To Link-Live:** Export the current settings directly to the [Link-Live](#) cloud service.

See [Exporting/Importing App Settings](#) (below) for more details.

Saving a Default Test App Configuration

If you find you are frequently resetting app defaults, you can save  the default configuration of settings for later use within the NetAlly testing apps. Loading a saved default configuration within an app allows you to access the default settings without deleting other configurations. This strategy can be most useful for [Discovery Settings](#) and [Problem Settings](#).

1. Go to an app's settings  screen.
2. With all settings set to the defaults, tap the save button  and **Save As**.
3. Save a default configuration with an obvious name like "Default Profiles" or "Discovery Defaults."
4. Do not change the settings in your default configuration to non-defaults without also saving a new, custom-named configuration.

Import/Export Settings

EtherScope nXG provides functionality for importing and exporting saved test app settings for transfer to additional units, Link-Live, USB storage, or to other devices.

NOTE: You can import and export settings only between the same kind of NetAlly products. For example, both units must be EtherScope nXGs for a transfer to work.

The following apps enable you to import and export settings and configurations:

- [AutoTest Settings, including Profile Groups](#)
- [Discovery Settings](#)
- [Discovery > Problem Settings](#)
- [Performance Settings](#)
- [iPerf Settings](#)

The AutoTest Settings are shown as an example in the images below.

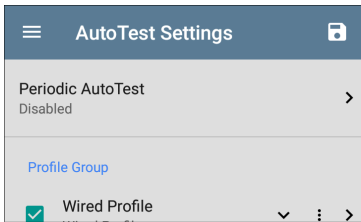

- Tap the save button  to import new app settings or export the *currently active and selected* app settings.

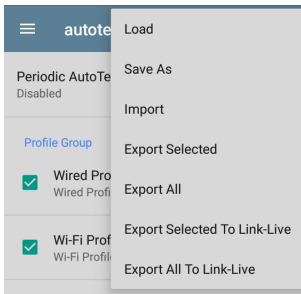

- Selected (checked) items in shared lists of configurations are the only ones exported when you choose **Export Selected**. This can include any checked items in submenus (such as AutoTest Test Targets or Community Strings in [Discovery Settings](#)). You can also select **Export All** to export all selected and unselected items.
- Unsaved configurations without a custom name are auto-named with the app name and date:

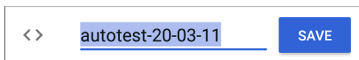

The image shows a screenshot of a configuration name field. On the left, there are angle brackets '< >'. To their right is a text input field containing the text 'autotest-20-03-11'. The text is highlighted with a blue selection bar. To the right of the input field is a blue button with the word 'SAVE' in white capital letters.

- Saved configurations are auto-named with the app name and custom settings name:

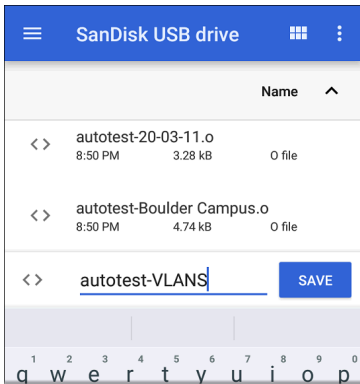

- You can rename the export file as needed.
- Settings can be saved to any connected external or internal storage. See [Managing Files](#) for instructions on accessing folders and moving files.
- Settings are saved with the `.o` file extension.

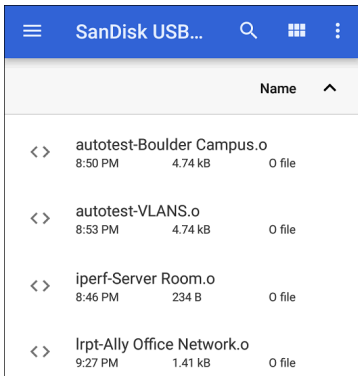

	Name			
<>	autotest-Boulder Campus.o	8:50 PM	4.74 kB	0 file
<>	autotest-VLANS.o	8:53 PM	4.74 kB	0 file
<>	iperf-Server Room.o	8:46 PM	234 B	0 file
<>	lrpt-Ally Office Network.o	9:27 PM	1.41 kB	0 file

- Selecting **Import** from an app opens the [Files](#) app, where you can navigate to and select the .o file you want to import.
- Imported settings configurations overwrite existing saved configurations with the same name that are already in the app.

Transferring AutoTest Settings to Other Devices Using Link-Live

You can use the Link-Live cloud service to transfer AutoTest settings with other EtherScope

nXG devices.



- Do some setup before you begin.
- Export the settings file(s) that you want to share to Link-Live.
- Use Link-Live to select other devices to which you want to transfer the settings.
- Use each selected unit to import the settings.

Before You Begin

- Make sure that you have access to the following:
 - a. The device from which you will get the settings
 - b. A PC-based browser
 - c. The devices to which you will transfer the settings file
- Make sure that you have claimed and updated the software for all EtherScope nXG devices to which you want to transfer the settings. (You can use the Link-Live app or web site to do the claiming. See [Claiming the Unit](#) for instructions.)

Export the Settings File(s)

This procedure is done on the device from which you are transferring the settings.

1. In the AutoTest app main page, tap the settings icon  in the top right. This opens the list of profiles.
2. If you plan to export only selected profiles, use the checkboxes to choose those profiles from the list.
3. Tap on the save icon  in the top right to display the save menu options.

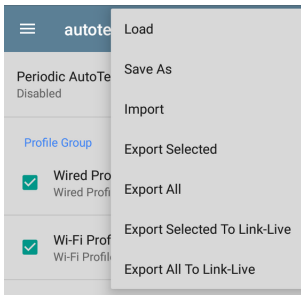

4. Tap **Export Selected To Link-Live** (if you selected profiles) or **Export All To Link-Live** on the menu. This opens the save screen for Link-Live.

**Link-Live**
by NetAlly

Settings File Name

autotest-shared settings

Comment

Update for all units

Job Comment

New profiles

EXPORT TO LINK-LIVE

5. (Optional) Edit the file name, add a comment, or add a job comment on the screen.
6. Tap **Export To Link-Live**. This uploads the file to Link-Live.

Use Link-Live to Select Other Devices

This procedure is best performed on a PC-based browser.

1. Use a PC-based browser to log in to the Link-Live web site.
2. Tap the main menu icon .
3. Click on **Settings** to open the settings menu.
4. Select **EtherScope nXG** to list the .o settings files available for your devices.
5. Select the settings file you want to transfer.
6. Follow the screen instructions to transfer the file to specific units or to all units that you have claimed.

Use Each Selected Unit to Import the Settings

This procedure is performed on the device to which you want to apply the settings.

1. Wait for up to 30 seconds after the file was pushed from Link-Live.
2. Swipe (touch and drag) downwards from the Status Bar at the very top of the home screen to display the Notification Panel.
3. Locate the notification that says there are new AutoTest settings from Link-Live and lists the profile name.

 AutoTest

New settings from Link-Live
autotest-autotest trial.o

4. Tap on that notification to open the AutoTest application.
5. Tap on the save icon  in the top right.
6. Tap on **Import** and navigate to Downloads.



7. Select the downloaded .o file to apply the new profile settings.

Import/Export Settings for All Apps

Your EtherScope nXG supports the importing or exporting of settings for *all* applications that allow import/export of settings.

NOTE: You can import and export settings only between the same kind of NetAlly products. For example, both units must be EtherScope nXGs for a transfer to work.

To perform a group export or import:

1. Open the About Screen by tapping the navigation menu icon  in any NetAlly application and then tapping **About**.
2. Tap the action overflow icon  to display the export or import menu.
3. To import settings:

- a. Tap **Import EtherScope nXG Settings**. This opens the [Files](#) app to the default Settings folder.
 - b. (Optional) Use the Files app to navigate to a different folder.
 - c. Select the .nas settings file you want to import.
 - d. Tap **Yes** at the prompt to import the settings for all apps at the next system restart.
4. To export settings:
- a. Tap **Import EtherScope nXG Settings**. This opens a dialog with a system-generated file name and the default Save To folder.
 - b. (Optional) Tap the Save To folder or tap Save As to open the [Files](#) app to select a different folder.
 - c. Tap **Save** to save the settings file.

Resetting EtherScope nXG Factory Defaults

 **CAUTION:** Resetting your device to factory defaults can delete *all* test results, user-installed applications, testing app settings, and saved files.

1. Make sure to [back up any files](#) you wish to keep before resetting.
2. Open the system [Device Settings](#) by tapping the Settings  icon at the bottom of the Home Screen.
3. On the Settings screen, scroll down to and tap on the **System** section.
4. On the System screen, tap **Reset options**.

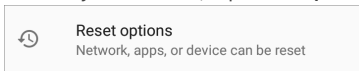

5. On the Reset options screen, select an option based on the defaults you want to reset. Your EtherScope displays a list of the items that will be reset based on the option

and a confirmation button.

Reset Wi-Fi, mobile & Bluetooth: resets all network settings for Wi-Fi (test and management), mobile data, and Bluetooth.

Reset app preferences: resets any preferences or settings for applications, although app data is not lost.

Erase all data (factory reset):

 **CAUTION:** Erases *all* user data from your tester's internal storage, including: system and app data and settings; downloaded apps; test profiles; credentials; packet information; and screen captures.

6. Tap the confirmation button to begin the reset.
7. Your unit may ask you to confirm again before resetting. If so, tap the final confirmation button to reset your EtherScope's defaults. The unit then restarts with the factory default settings you selected.
8. Data on removable drives is not included in the reset. To be thorough, you may also

want to use the [Files application](#) to delete any application settings, preferences, or other data that you have saved on an attached Micro SD card or a USB thumb drive. (Do not delete your backup files.)

EtherScope nXG Feature Access

This chapter explains how to semi-permanently control the availability of features on your EtherScope nXG.

Tap a link below to skip to your desired topic:

[Introduction to EtherScope nXG](#)

[Controlling Feature Availability](#)

[Changing the Admin Password](#)

Introduction to Feature Access

The EtherScope nXG provides the ability to semi-permanently disable certain features to meet a variety of security needs. These features are referred to as controlled features.

Controlled features have categories to help you identify which features can be disabled.

Removable Storage

- USB Access
- Micro SD Access

Connectivity Apps

- Browser App
- Telnet/SSH App

Remote Control

- VNC

Wireless

- Management Wi-Fi
- Bluetooth

Documenting

- Packet Capture
- Network Discovery
- Camera
- Microphone

Link-Live Cloud Service

- Link-Live Access
- Download from App Store

Removable Storage

USB Access

Both the USB Type-A port on the top of the unit and the Type-C port on the left side of the unit are deactivated when the USB Access feature is disabled. This means that there can be no data transfer in either direction via these ports and that external devices cannot receive power from these ports.

NOTE: The USB Type-C port continues to function to support powering the unit using the AC adapter.

Micro SD Access

The Micro SD card slot on the left side of the unit is deactivated when the Micro SD Access feature is disabled. The operating system no longer recognizes an inserted Micro SD card and no data transfer in either direction is possible.

NOTE: The Micro SD card slot is temporarily re-activated for recovery mode operation. See [Manual Updates](#) for a description of updating the software using recovery mode.

Connectivity Apps

Browser App

The Chromium browser is removed if you disable the Browser App feature. All NetAlly apps that normally provide access to the Chromium browser remove that option. Other apps cannot access the browser.

NOTE: If you re-enable the Browser App feature, the Chromium browser, User Guide, and Video apps are restored but do not appear on the Home screen. See [Apps](#) for more information about the Apps screen.

Telnet/SSH App

The JuiceSSH app, which provides Telnet and SSH client services, is removed when the Telnet/SSH App feature is disabled. All NetAlly apps that normally provide access to this app remove this option.

Remote Control

VNC

The ability to remotely access and control the product UI using a standalone VNC client is deactivated when the VNC feature is disabled. See [Remote Access](#) for more information about this capability.

NOTE: The Link-Live Remote feature remains active when VNC is disabled. To deactivate Link-Live Remote, Link-Live Access must be disabled.

Wireless

Management Wi-Fi

The internal Wi-Fi Management Port, which runs on the main system's 1x1 Dual-band 802.11ac +

Bluetooth 5.0 wireless adapter and external Wi-Fi adapters, is deactivated when the Management Wi-Fi feature is disabled. All NetAlly apps that normally provide access to the Wi-Fi management port will remove access to the port.

NOTE: See [Test and Management Ports](#) for more information.

Bluetooth

The internal Bluetooth Port, which runs on the main system's 1x1 Dual-band 802.11ac + Bluetooth 5.0 wireless adapter, is deactivated when the Bluetooth feature is disabled. Peripheral access and data transfer over Bluetooth is not possible.

Documenting

Packet Capture

The Capture app is disabled when the Packet Capture feature is disabled. All NetAlly apps that normally provide access to the Capture app will remove this option.

NOTE: See [Capture](#) for more information.

Network Discovery

The Upload to Link-Live or Save Locally function in the Discovery and Wi-Fi apps are disabled.

NOTE: See [Discovery](#) for more information.

Camera

The built-in camera on your unit is deactivated when the Camera feature is disabled.

Microphone

The built-in microphone on your unit is deactivated when the Microphone feature is disabled.

Link-Live Cloud Service

Link-Live Access

The [Link-Live](#) app is disabled when the Link-Live Access feature is disabled. All NetAlly apps and services that provide an interface to Link-Live will remove access.

NOTE: The Link-Live Remote feature and the App Store app are also disabled when Link-Live Access is disabled.

Download from App Store

The App Store app is disabled when the Download from App Store feature is disabled. Adding additional apps to the product is not possible.

NOTE: Disabling Link-Live Access also disables the App Store app.

Controlling Feature Access

The EtherScope nXG supports disabling (and re-enabling) certain features to meet a variety of security needs. These features are referred to as controlled features.

Use the **Feature Access** selection to manage feature access. It is accessible from the left-side [navigation drawer](#) in NetAlly apps, such as AutoTest and Ping/TCP.

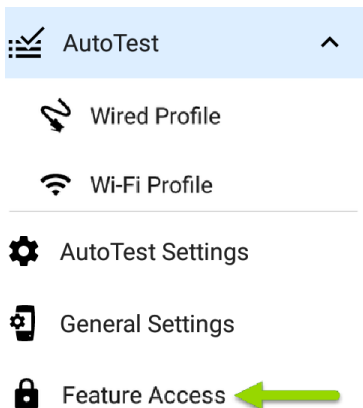

Select **Feature Access** to view the **Feature Access** status screen. This screen shows the current state of the controlled features.

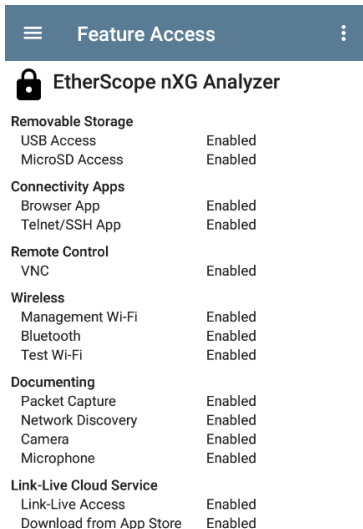

Feature Access	
EtherScope nXG Analyzer	
Removable Storage	
USB Access	Enabled
MicroSD Access	Enabled
Connectivity Apps	
Browser App	Enabled
Telnet/SSH App	Enabled
Remote Control	
VNC	Enabled
Wireless	
Management Wi-Fi	Enabled
Bluetooth	Enabled
Test Wi-Fi	Enabled
Documenting	
Packet Capture	Enabled
Network Discovery	Enabled
Camera	Enabled
Microphone	Enabled
Link-Live Cloud Service	
Link-Live Access	Enabled
Download from App Store	Enabled

To change access to a controlled feature, tap the action overflow icon , and then tap the **Settings** option.

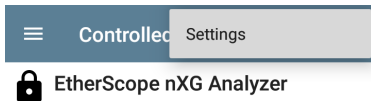

When prompted, enter the admin password, and then tap the **OK** button.

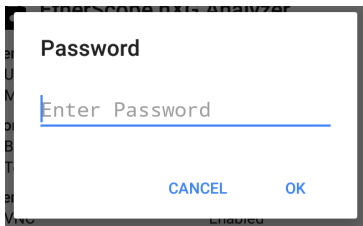

The **Feature Access** screen shows the current state of the controlled features and lets you turn features off or on using the toggle

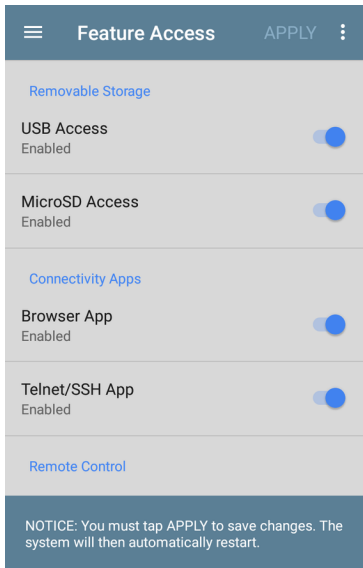

Feature Access

APPLY

Removable Storage

USB Access
Enabled

MicroSD Access
Enabled

Connectivity Apps

Browser App
Enabled

Telnet/SSH App
Enabled

Remote Control

NOTICE: You must tap APPLY to save changes. The system will then automatically restart.

If you make changes, the **Apply** button at the top of the screen becomes active.



Feature Access

APPLY

Tap **Apply** as the first step in completing the changes.

A message lists the pending feature changes.

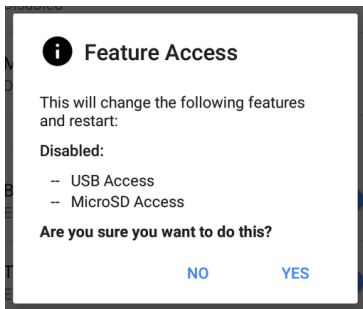

- Select **Yes** to make the pending changes
- Select **No** to cancel the pending changes and return to the Settings screen

After the changes are applied, the unit automatically restarts.

To view the state of the controlled features, visit the **Feature Access** status screen.

Changing the Administrative Password

NetAlly recommends that you change the factory-set admin password when you configure **Feature Access** to prevent non-administrative users from gaining access to the **Feature Access** screen.

To change the admin password:

1. Follow the procedure in [Controlling Feature Availability](#) to access the **Feature Access** selection screen.
2. From the selection screen, tap the action overflow icon  at the top of the screen to display the overflow menu.

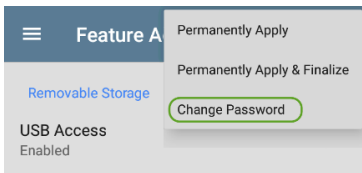

3. Select **Change Password** to display the Current Password entry screen.

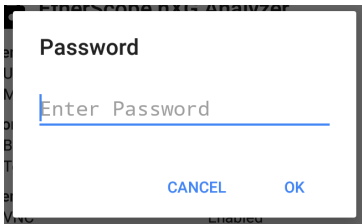

4. Enter the current admin password and tap **OK** to continue. (Select **CANCEL** to return to the **Feature Access** selection screen without making any changes.)

Note: The factory-set administrative password is: **admin**

5. Wait for the New Password entry screen to display, enter the new password in both fields, and then tap **OK** to complete the admin password change. (Select **CANCEL** to return to the **Feature Access** selection screen without changing the current admin

password.)

Note that you cannot complete the admin password change until the new password fields contain matching entries.

New Password

Enter new password

Confirm new password

CANCEL **OK**



EtherScope nXG Testing Applications

This section of the User Guide describes the NetAlly-developed network testing apps. Each app is specially designed for fast analysis and intuitive operation to enhance and simplify your network tasks.

Open the testing apps by selecting their icons from the Home screen or the Apps screen.



AutoTest App and Profiles

AutoTest is the most comprehensive NetAlly testing application on EtherScope nXG. You can quickly run a variety of test types and save their configurations and network credentials for access whenever you need them. The app is fully customizable with test "Profiles" for **Wired** and **Wi-Fi**, wireless **Air Quality** network connections, as well as individual **Test Targets**

AutoTest establishes the **Wired and Wi-Fi Test Port connections** used by other testing apps, like Ping/TCP, Capture, and Performance.

AutoTest results are automatically uploaded to **Link-Live Cloud Service** after you claim your EtherScope.

AutoTest Chapter Contents

This chapter describes AutoTest Profiles, screens, settings, and test results.

[AutoTest Overview](#)

[Managing Profiles and Profile Groups](#)

[Main AutoTest Screen](#)

[Periodic AutoTest](#)

[Wired AutoTest Profiles](#)

[Wi-Fi AutoTest Profiles](#)

[DHCP, DNS, and Gateway Tests](#)

[Test Targets](#)

AutoTest Overview

AutoTest consists of three distinct testing levels: **Test Targets**, **Profiles**, and **Profile Groups**. You can create as many Profile Groups, Profiles, and Test Targets as you need.

Profile Groups

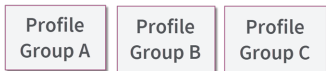

Profiles

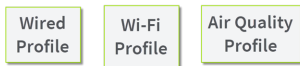

Test Targets



At the bottom level is a set of individual **Test Targets** that connect to network services, such as a web app or FTP site. A Test Target defines parameters including type, target URL/IP address, port number, and Pass/Fail thresholds. More complex tests, like HTTP, allow further Pass/Fail criteria, such as strings that must or must not be contained in the HTTP body.

A Test Target can be added to and used in any number of **Profiles**.

A **Profile** contains a series of individual network tests. There are three different Profile types: Wired, Wi-Fi, and Air Quality. The Wired and Wi-Fi Profiles include connection tests and credentials for a Wi-Fi network or Wired VLAN. Air Quality is a passive scan of your wireless environment. Profiles provide an automated and consistent way to verify a network from layer 1 through layer 7.

A Profile can be added to and used in any number of **Profile Groups**.

A **Profile Group** is a custom-named collection of Profiles. Profile Groups are designed to allow further automation for testing multiple networks or network elements with a single tap of the START button.

A Test Target can be in any number of Profiles, and a Profile can be in any number of Profile Groups.

For example, you can:

- Test multiple Wired VLANs on a trunk port.
- Test multiple Wi-Fi SSIDs from a single location.
- Test both wired and Wi-Fi access from a conference room.

The graphic below shows each of these scenarios.

Profile Groups

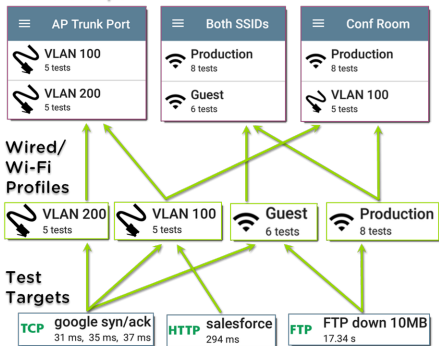

Managing Profiles and Profile Groups

Profiles are a series, or suite, of tests designed to analyze the different characteristics of your networks. The EtherScope nXG AutoTest app features three types of test profiles:

Wired Profiles to test copper and fiber connections.

Wi-Fi Profiles to test wireless connections.

Air Quality Profiles to measure channel utilization and interference.

Factory Default Profiles

The EtherScope begins with a default version of the AutoTest profile types, which you can customize, delete, or replace for your purposes.

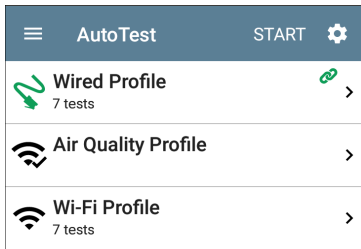

To customize each Profile with the required network settings and a custom name, tap the Profile name *first*, and then select the settings  icon.

NOTE: Tapping the settings icon on the main AutoTest screen (shown above) opens the [AutoTest Settings and Profile Group](#) screen, not the individual Profile settings.

- The default **Wired Profile** runs automatically and establishes a wired link as soon as your unit is powered on and an active Ethernet connection is available on the [top RJ-45 port](#).

NOTE: The default Wired Profile does not run automatically over a fiber link. You must tap

START in AutoTest to run a Wired Profile on a fiber connection.

- The default **Air Quality Profile** runs when you tap **START** on the main AutoTest screen or the Air Quality screen.
- For the default **Wi-Fi Profile** to run successfully, you must select an SSID and enter security credentials before the EtherScope can connect to a network.



See [Wi-Fi Profile Connection Settings](#).

Adding New Profiles

To add new test profiles to the current AutoTest, tap the floating action button (FAB) on the AutoTest screen.

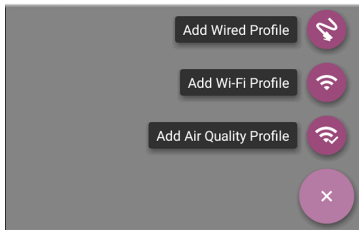



The profile's configuration screen appears after you select the type of profile you want to add. See the topic for each profile type for a description of its settings.

After you configure the profile settings, tap the back button  at the bottom of the screen to open and run the new test profile.

Creating a Wi-Fi Profile from the Wi-Fi Analysis App

You can also create an AutoTest Wi-Fi Profile from the [Wi-Fi Analysis](#) app's [SSID](#) or [BSSID](#) Details screen. This is a quick and easy way to add a Profile to connect to a Wi-Fi network in your vicinity.

1. Open the **Wi-Fi app**  from the Home screen.
2. Tap the menu button  to select the **SSIDs or BSSIDs** list screen.

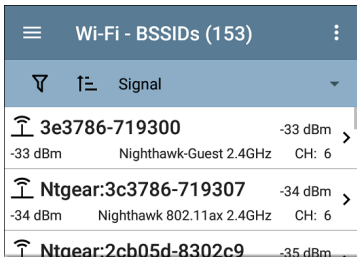

3. Tap an SSID or BSSID's card to open its Details screen.
4. Tap the FAB (floating action button)  to open the floating action menu.

Wi-Fi - BSSID

 **Ntgear:3c3786-719307**
BSSID

SSID: **Nighthawk 802.11ax**

AP: **192.168.1.1**

BSSID: 3c3786-719307

802.11

Channel: 1

Types: ax, n, g, b

Signal: -30 dBm

SNR: 64 dB



Security Type: WPA2-E



Last Seen: 11:38:24 PM

Locate 

Connect 

↑↓ Rates and Capabilities 

 Clients 

 RF and Traffic Statistics 

CH: 1 Utilization: 7%

5. In the floating action menu, tap **Connect**.

A Wi-Fi Profile called "Connect to [SSID/BSSID]" is created in AutoTest.

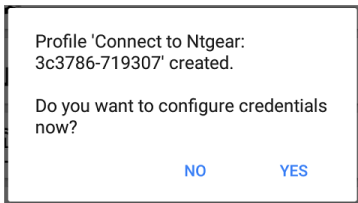

The SSID, BSSID (if applicable), and Authentication Type are auto-populated in the [Wi-Fi Connection settings](#) for the new profile.

6. Tap **YES** in the pop-up dialog to review and configure additional credentials.

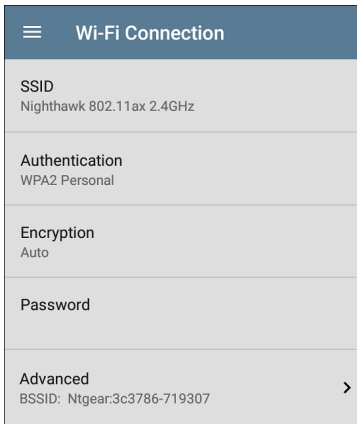

7. Enter any additional credentials, like the network Password.
8. After configuring, tap the back button  to return to and run the new Profile.

Profile Groups

EtherScope nXG also allows you to save Profile Groups. Profile Groups are simply **the included list of test Profiles and the order in which they run** when you start an AutoTest. (See [AutoTest Overview](#) for more explanation of Profile Groups.) You can configure and select Profiles and Profile Groups for different locations, jobs, networks, or other purposes.

To manage your Profiles and Profile Groups, tap the Settings  button on the main AutoTest screen (with the list of Profiles).

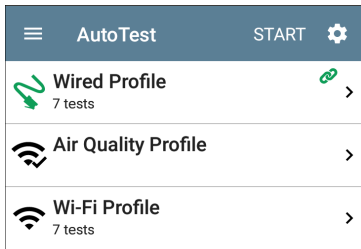

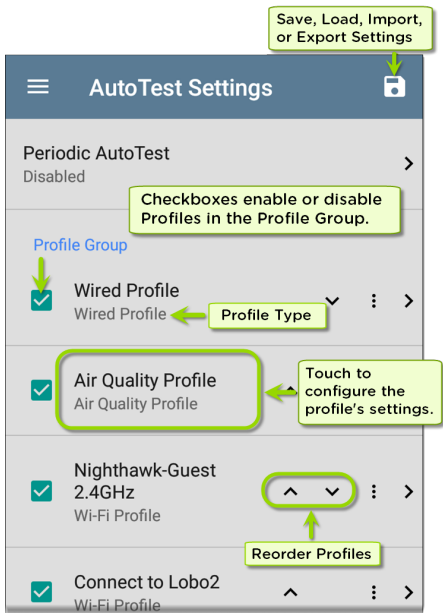

AutoTest Settings Screen

The AutoTest Settings screen contains the **Periodic AutoTest** and Profile Group settings.



You can perform these actions on the AutoTest Settings screen:

- Check or uncheck the boxes to include or exclude a test Profile from the currently active Profile Group.
- Tap the up and down arrows  to reorder the test Profiles on this and the main AutoTest screen for the Profile Group.
- Tap the action overflow icon  to **Duplicate** or **Delete** a Profile.

CAUTION: When you delete a Profile, it is deleted from all Profile Groups. To remove a Profile from the current group, simply uncheck it.

- Tap any Profile's name to open the test and connection settings for the Profile.
- Tap the save icon  to perform the following actions:
 - **Load:** Open a previously saved settings configuration, which includes the Profile Group.

- **Save As:** Save the current settings and Profile Group with an existing name or a new custom name.

See also [Saving App Settings Configurations](#).

- **Import:** Import a previously exported settings file.
- **Export:** Create an export file of the current settings, and save it to internal or connected external storage.

See [Exporting and Importing App Settings](#) for more details.

Each Profile Group can run one or many instances of the profile types. Saved Profiles are available across all of your Profile Groups.

Custom AutoTest Settings/Profile Group Names

By default, the AutoTest app screen shows "AutoTest" in the header, and the AutoTest Settings screen header is "AutoTest Settings." Once you save a custom name, the name

displays in the AutoTest app header and in the AutoTest Settings screen header.

In the example below, the user saves a custom AutoTest configuration named "Springs Campus."

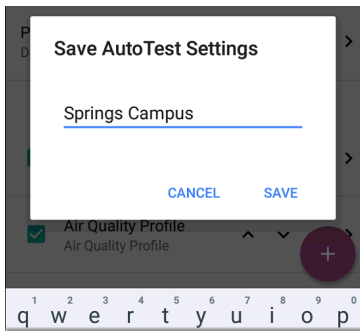

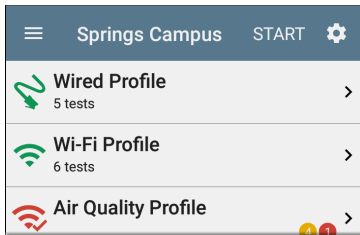

The main AutoTest app screen now displays the custom name in the header.



Creating New Profile Groups

To create a new Profile Group, follow these steps:



1. Go to the AutoTest Settings and Profile Group screen by tapping  on the main AutoTest screen.
2. Uncheck the boxes for any Profiles you do not want included in the new Profile Group.
3. Tap the **FAB**  to add new test Profiles to be included in your new Profile Group.
4. Tap the up and down arrows  to change the order in which the test Profiles run. Unchecked profiles automatically move

to the bottom of the list once you leave and revisit this screen.

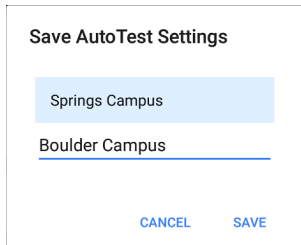
5. Tap , and select **Save As**. A dialog box opens, where you can enter the new name.









6. Enter a new Profile Group name, and tap **SAVE**. The EtherScope returns to the Profile Group screen with the new group name shown as the title.



 **Boulder Campus** 



Periodic AutoTest 
Enabled

Profile Group

Wired Profile   
Wired Profile

Air Quality Profile    
Air Quality Profile

Connect to The Office Network #1   
Wi-Fi Profile

Nighthawk 802.11 ax 5GHz  
Wi-Fi Profile

LRC 
Wi-Fi Profile

When running the "Boulder Campus" configuration shown above, AutoTest first runs the Wired Profile over the Ethernet connection, then scans the wireless channels for Air Quality results, and then connects to "The Office Network #1" and remains connected to that network. This Profile Group will *not* connect to or test the "Nighthawk..." or "LRC" networks.

Import/Export AutoTest Profiles

In addition to creating new profiles or using defaults, you can also:

- Import and export profile settings to any connected external or internal storage. See [Import/Export Settings](#).
- Use the Link-Live cloud service to transfer profile settings to other devices in near-real time. See [Transferring AutoTest Settings to Other Devices Using Link-Live](#).

Main AutoTest Screen

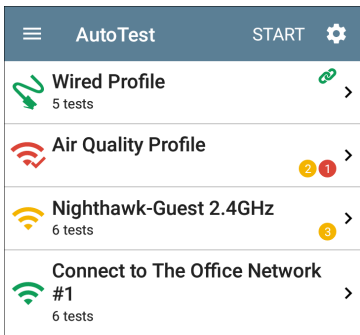

To open the AutoTest app, tap the AutoTest icon  on the [Home screen](#).

Tap the **START** button on the main AutoTest screen to run all the Profiles in the currently active [Profile Group](#).



The AutoTest screens display icons that correspond to the type of profile, test, or measurement. After running, these icons change color to indicate the status of the test:

- **Green** indicates a successful test or measurement within the set threshold.
- **Yellow** indicates a Warning condition.
- **Red** indicates test Failure.

The number of warnings or failures within each test profile is also displayed in a colored circle to the right of each profile card:   (2 Warnings, 1 Failure). The thresholds that control the colored test gradings are adjustable in the settings  screens for each profile and test type.

The green link icon  indicates an active network connection.

Each profile and test is summarized on a card. Tap a profile's or individual test's card to open and view test result details, including the causes of any Warnings or Failures.

Periodic AutoTest

The Periodic AutoTest feature allows you to run AutoTests at set time intervals.

Periodic AutoTest Settings

To enable and configure Periodic AutoTest, open the [AutoTest Settings and Profile Group](#) screen, and tap **Periodic AutoTest**.

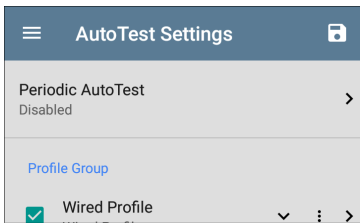

The Periodic AutoTest settings screen displays the following options:

Periodic AutoTest	
Periodic AutoTest Enabled	<input checked="" type="checkbox"/>
Interval 10 minutes	
Duration 2 hours	
Add Comment Enabled	<input checked="" type="checkbox"/>
Comment AT Boulder Site	
Append Date & Time Enabled	<input checked="" type="checkbox"/>

Tap the **Periodic AutoTest** field to enable, and adjust the settings below as needed.

Interval: Amount of time between each AutoTest run

Duration: Total length of time Periodic AutoTests run

Add Comment: Enabling this setting allows you to attach a comment to the Periodic AutoTest result in Link-Live Cloud Service. The comment appears as a label on the [Link-Live.com](https://link-live.com) Results page. This setting and the **Comment** setting below are enabled by default.

Comment: This field appears if the **Add Comment** setting is enabled. Enter the label you want to be attached to the uploaded Periodic AutoTest result on Link-Live. The default is "Periodic AutoTest."

Append Date & Time: This field appears if the **Add Comment** setting is enabled and adds a numeric date and time to the end of the **Comment** above.

Running Periodic AutoTest

Tap **START** on the main AutoTest screen to begin Periodic AutoTests. AutoTest continues to run at the set Interval for the selected Duration or until you tap **STOP** in AutoTest.

AutoTest Settings STOP

- Wired Profile**
7 tests
- Air Quality Profile**
9 1
- CiscoE4200-5G**
6 tests

Periodic AutoTest Status
Passed: 11
Failed: 25
Skipped: 3
Time Remaining: 21 m
Next: 2 s

The Periodic AutoTest Status is summarized at the bottom of the AutoTest screens. Passes and failures are reported for each run of the entire Profile Group, rather than individual Profiles. Periodic AutoTests are skipped if the previous interval's test is still running when the next time interval occurs, such that the next run could not start.

The Periodic AutoTest icon  appears in the top [Status Bar](#) when Periodic AutoTest is running or has completed. Drag down on the Status Bar to view the corresponding notification.

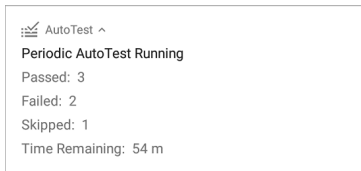

NOTE: AutoTest has priority control of the [Test Ports](#), so other apps, including [Discovery](#), [Wi-Fi](#), [Wi-Fi Capture](#) (but not [Wired Capture](#)), and [AirMapper](#), are paused while AutoTest completes.

Wi-Fi AutoTest Profiles

A Wi-Fi Profile runs a series of tests by connecting to a selected wireless network.

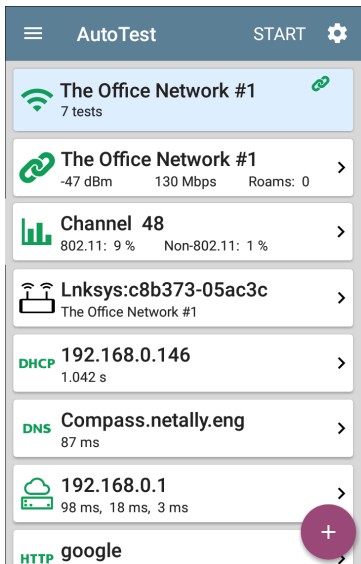

The screenshot shows the AutoTest app interface. At the top, there is a blue header with a hamburger menu icon on the left, the text "AutoTest" in the center, and "START" and a gear icon on the right. Below the header is a list of items, each with an icon on the left and a chevron on the right. The items are:

- The Office Network #1** (Wi-Fi icon) with a link icon on the right and "7 tests" below it.
- The Office Network #1** (Link icon) with "-47 dBm", "130 Mbps", and "Roams: 0" below it.
- Channel 48** (Bar chart icon) with "802.11: 9 %" and "Non-802.11: 1 %" below it.
- Lnksys:c8b373-05ac3c** (Router icon) with "The Office Network #1" below it.
- DHCP 192.168.0.146** (DHCP icon) with "1.042 s" below it.
- DNS Compass.netally.eng** (DNS icon) with "87 ms" below it.
- 192.168.0.1** (Cloud icon) with "98 ms, 18 ms, 3 ms" below it.
- HTTP google** (HTTP icon) with no additional text below it.

A purple circular button with a white plus sign is located at the bottom right of the list.

Like the main AutoTest screen, Wi-Fi Profile tests are summarized on cards. Tap a card to view individual test screens.

Each test icon (except the AP) displays green, yellow, or red to indicate the status (or grade) of the completed test step: **Success/Warning/Fail**. The AP Test card shows the name and SSID of the connected AP. The AP test is not graded, so the icon stays black.

Wi-Fi Profiles do not run automatically. The factory default Wi-Fi Profile cannot run until you have configured an SSID with the proper credentials. (By default, AutoTest starts in Wi-Fi passive scanning mode if you do not have a profile set up.)



See the [Wi-Fi Profile Settings](#) topic for instructions.

After connecting to a network during a Wi-Fi connection test, EtherScope nXG remains connected until you run another Wi-Fi or [Air Quality](#) Profile or open the [Wi-Fi app](#). Wi-Fi Test

Port linkage is indicated in the top [Status Bar](#) with this notification icon, , which also shows the connected channel.

NOTE: When running an AutoTest Profile that connects to a network with a [Captive Portal](#), a system notification icon  appears in the top Status Bar. Open and select the notification to open a web browser window where you can enter the required information for the captive portal.

Wi-Fi-Profile-Specific AutoTests

The tests that are specific to a Wi-Fi Profile include the wireless Link, Channel, and AP tests.

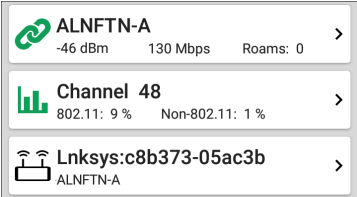

The screenshot shows three stacked cards for a Wi-Fi profile named 'ALNFTN-A':

- Link Card:** Features a green chain-link icon. It displays '-46 dBm', '130 Mbps', and 'Roams: 0'. A right-pointing chevron is on the right side.
- Channel Card:** Features a green bar chart icon. It displays 'Channel 48', '802.11: 9 %', and 'Non-802.11: 1 %'. A right-pointing chevron is on the right side.
- AP Card:** Features a white Wi-Fi router icon. It displays 'Lnksys:c8b373-05ac3b' and 'ALNFTN-A' below it. A right-pointing chevron is on the right side.

The link and channel cards update in real time to display the connection measurements for as

long as EtherScope remains connected to the wireless network.

- Skip to [Wi-Fi Profile Settings](#).
- Skip to [Wi-Fi Profile Results](#).
- Skip to [DHCP, DNS, and Gateway Tests](#).
- Skip to [Test Targets](#).

Wi-Fi Profile Settings

These settings control which network is tested, how the EtherScope nXG connects, thresholds for **Success/Warning/Fail** results, and any user-added test targets.

To configure the profile settings, tap the settings icon  on the Wi-Fi Profile screen, or [add a new Wi-Fi Profile](#) to AutoTest.

Tap the links below to skip to later sections in this topic:

- [Wi-Fi Connection Settings](#)
- [Certificates](#)
- [Advanced Wi-Fi Connection Settings](#)
- [Channel Test Settings](#)

Wi-Fi Profile	
Name Connect to The Office Network #1	
Wi-Fi Connection The Office Network #1 / WPA2 Personal	>
Channel Test 2 enabled thresholds	>
IP Configuration DHCP: Enabled	>
DNS Test www.google.com	>
Gateway Test Timeout Threshold: 100 ms	>
Test Targets 0 target(s)	>

On the **Wi-Fi Profile** settings screen, tap each field described below as needed to configure the profile. Changed settings are automatically applied.

NOTE: If you add a new Wi-Fi profile from the [Wi-Fi Analysis](#) app, the Profile Name, SSID, and Authentication type are auto-populated. See [Creating a Wi-Fi Profile from the Wi-Fi Analysis App](#).

When you finish configuring, tap the back button  to return to the profile.

Name

Tap the **Name** field to enter a custom name for the profile. This name appears on the main AutoTest screen profile card and the Wi-Fi profile screen header.

Wi-Fi Connection Settings

Open **Wi-Fi Connection** settings to configure network IDs, security credentials, and test thresholds for the Link  test. These settings control the [Wi-Fi Test Port](#) connection.

Wi-Fi Connection	
SSID	The Office Network #1
Authentication	WPA2 Personal
Encryption	Auto
Password	*****
Advanced	BSSID: Any >

SSID

Tap to enter an **SSID** or select from the list of discovered SSIDs. If you do not enter a custom **Name** for the Profile, the SSID is displayed as the Wi-Fi Profile's name.

Authentication

If you selected an **SSID** from the drop-down list of discovered SSIDs in the setting above, or

created a "Connect to [SSID]" profile from the Wi-Fi app, the Authentication type is automatically selected. If needed, tap to open the **Authentication** dialog and select the correct security type for the network.

The following settings depend on the Authentication type. Enter all necessary credentials for the network security type, such as Encryption, Keys, EAP type, username, certificate, and/or password.

WEP Key

This setting appears if the Authentication type is **WEP Shared** or **WEP Auto**. Tap to select the correct key type (ASCII or Hex) and enter the key.

Encryption

Tap to select an encryption type if needed. The default is "Auto."

EAP Type

This setting appears if the Authentication type is **WPA/WPA2/WPA3 Enterprise**. The default is

PEAP MSCHAP V2. Tap to select a different EAP type if needed.

Username

This field appears along with multiple authentication types. Tap the **Username** field to enter your username.

Certificate

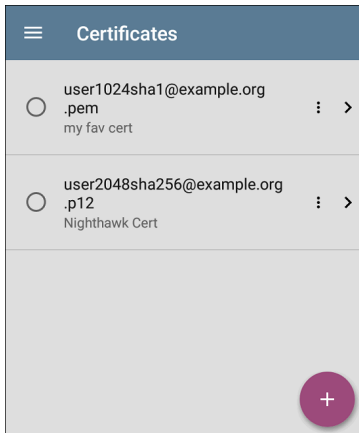

This setting appears if you selected one of the following EAP types: **EAP TLS**, **PEAP TLS**, or **TTLS EAP TLS**.

Tap to open the Certificates screen.



This screen displays all the certificates that have been imported to AutoTest via the Wired or Wi-Fi Profile settings.

- Tap the radio button to the left of an imported certificate to select and use it with the current Profile.
- Tap a certificate's row to edit its name and description.

- Tap the action overflow icon  to **Delete** an imported Certificate.
- Tap the floating action button (FAB)  to import a new certificate file.

EtherScope nXG supports these certificate file extensions:

- .pem
- .p12
- .cer
- .crt

The imported certificate feature is meant for client authentication and must include the private key. The EtherScope supports 1-way client authentication only; mutual authentication, Server, and CA/Root certificates are not supported. While EtherScope can perform a key exchange, it does not authenticate the server certificate.

[Tap here](#) to skip the following "How to" section and go to [Advanced Wi-Fi Connection Settings](#).

How to Import a Certificate:

Certificate files can be imported from either an inserted storage device (USB or Micro SD) or the

EtherScope's internal file system.

1. Make the certificate file available on your EtherScope unit by saving it to a USB drive or Micro SD card inserted into your unit or by transferring to the file system using a USB-C cable or email. (See [Managing Files](#) for help.)
2. To run an [AutoTest Wi-Fi Profile](#) using certificate authentication, set up the profile with the following settings:
 - a. Authentication: **WPA/WPA2/WPA3 Enterprise**
 - b. Encryption: **Auto**
 - c. EAP Type: **EAP TLS, PEAP TLS, or TTLS EAP TLS**

To run an [AutoTest Wired Profile](#) using 802.1X with certificate authentication, set up the profile with the following 802.1X test settings:

- a. 802.1X: **Enabled**
 - b. EAP Type: **EAP TLS, PEAP TLS, or TTLS EAP TLS**
3. In **AutoTest > Wi-Fi Connection** or **Wired Connection** settings, tap the **Certificate** setting to open the Certificates screen.

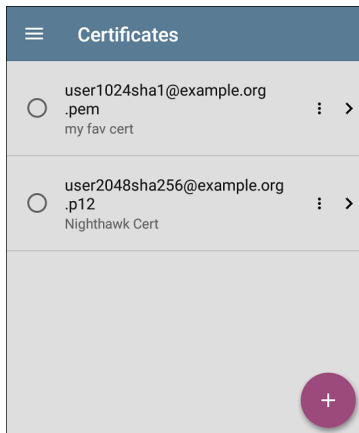

4. Tap the floating action button (FAB)  to open the Import Certificate dialog box.

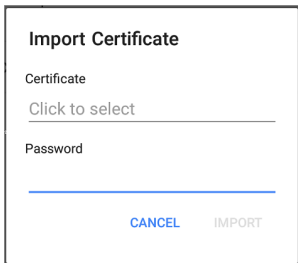

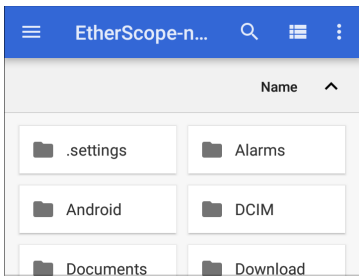

5. Tap **Click to select** beneath the Certificate field to open the [Files](#) app.



6. In the Files app, navigate to the folder or storage device where your certificate file is saved.
7. Tap the menu button  to open the left-side [navigation drawer](#).
8. Navigate to the required certificate file, and tap to select it.

After you select the file, the Files app closes, and the Import Certificate dialog displays the chosen certificate file.

9. Enter the certificate's password if it is password protected.
10. Tap **IMPORT**.
11. If desired, tap the fields to edit the **Name** and **Description** of the certificate. The name defaults to the certificate file name.
12. Tap the back button  to return to the Certificates list screen. The newly added certificate appears selected in the list.
13. Tap the back button  to return to the Connection settings.

After running the AutoTest, you can review the **Connect Log** from the [Wi-Fi Link Test screen](#) or [Wired 802.1X Test screen](#) to verify or troubleshoot certificate authentication.

Username

This field appears along with multiple authentication types. Tap the **Username** field to enter your username.

Password

This field appears along with multiple security types. Tap the **Password** field to enter the network password.

Advanced (Wi-Fi Connection) Settings

Advanced	
BSSID	Any
Wi-Fi Band	Auto
Roam Threshold	-70 dBm
Link Test Thresholds	4 enabled thresholds >
Alternate ID	
User-Defined MAC	<input type="checkbox"/> Disabled

BSSID

Enter or select a specific BSSID for the Wi-Fi Profile to prevent the EtherScope from roaming

to a new AP while linked.

Wi-Fi Band

Tap this setting to specify the wireless band(s) on which the Wi-Fi Profile attempts to connect. The default setting of Auto allows the unit to connect on any band. Note that the Profile fails to link if this setting conflicts with the selected bands in [General Settings](#).

Roam Threshold

This threshold controls the Signal Strength (in dBm) at which EtherScope stays connected and looks for another AP on the network with a stronger signal. If found, it disconnects from the current AP and connects to the AP with a stronger signal. Tap the field to select a new value or enter a custom one.

Link Test Thresholds

Open the **Link Test Thresholds** screen to adjust the values that determine **Success/Warning/Fail** results for the following measurements.

Link Test Thresholds

Signal Level Thresholds

Enabled

Warning
-70 dBm

Failure
-85 dBm

Signal-to-Noise (SNR) Thresholds

Enabled

Warning
25 dB

Failure
10 dB

Retries Thresholds

Enabled

Tap each field to select a new value or enter a custom one. Each threshold also has a toggle button that allows you to disable grading based on that measurement entirely.

Signal Level Thresholds: Measured signal from the AP

Signal-to-Noise (SNR) Thresholds: Ratio of measured AP signal to noise level detected on the channel

Retries Thresholds: Retry frames as a percentage of total transmitted frames

Transmit Rate (TX) Thresholds: Measured rate as a percentage of the AP's maximum throughput rate

Alternate ID

Enter an Alternate ID if necessary. This is an Advanced Authentication setting.

User-Defined MAC

(Not available for EXG-200 models.) This feature can help with tasks such as testing ACL lists (for example, finding out if specific MAC addresses are allowed on the network) or determining if specific IPv4 addresses should be assigned to specific MAC addresses.

1. Tap the toggle field to enable a user-defined MAC for the EtherScope. This displays the current user-defined MAC definition. (If you have not previously provided a definition, the field shows the factory default MAC address.)



2. To enter a new definition, tap the User-Defined MAC definition, enter a new definition, and then tap **OK**. When enabled, **(User-defined)** appears next to the MAC address on the [About](#) screen and on relevant test result screens.

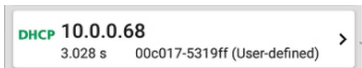

Channel Test Settings

Open **Channel Test** settings to configure Utilization thresholds for the channel test

portion of the Wi-Fi profile.

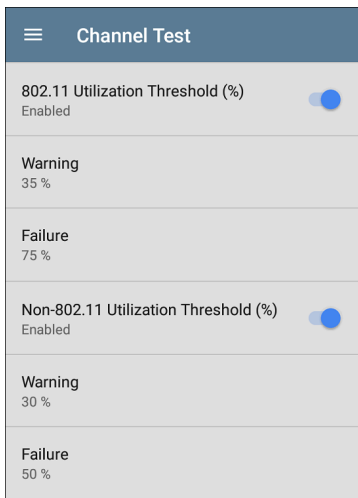

(EXG-200 only) If the **Combine Utilization** setting is enabled in [General Settings](#), only a single, combined **Utilization Threshold** setting appears.

802.11 Utilization Threshold (%)

This threshold controls the **Success/Warning/Fail** gradings for the percentage of the connected channel's capacity being used by 802.11 devices.

- Tap the toggle button to enable or disable test grading based on 802.11 utilization.
- Tap **Warning** or **Failure** to select or enter custom percentage values for Warning or Failure results.

Non-802.11 Utilization Threshold (%)

This threshold controls the **Success/Warning/Fail** gradings for the percentage of the connected channel's capacity being used by non-802.11 interference.

- Tap the toggle button to enable or disable test grading based on non-802.11 utilization.
- Tap **Warning** or **Failure** to select or enter custom percentage values for Warning or Failure results.

DHCP, DNS, and Gateway Settings

Settings for these tests operate the same in both Wired and Wi-Fi profiles.

See [DHCP, DNS, and Gateway Tests](#)

PING FTP TCP HTTP Test Targets

Tap the **Test Targets** field to open the Test Targets screen and add custom Ping, TCP Connect, HTTP, or FTP tests to your AutoTest profile. See [Test Targets](#) to learn more.

HTTP Proxy

The Proxy control lets you specify a proxy server through which the EtherScope establishes a network connection. In AutoTest, these settings are used when HTTP Proxy is enabled in an [HTTP](#) or [FTP](#) Test Target.

To use the proxy settings with a web browser, run the Profile, and then, open the web browser while the unit remains linked. When using a web browser, the [Wired Test Port](#) takes priority over the Wi-Fi Test Port, so if you want to browse via

Wi-Fi proxy connection, unplug the (top) Wired Test Port.

Open the **HTTP Proxy** screen to enable proxy settings.

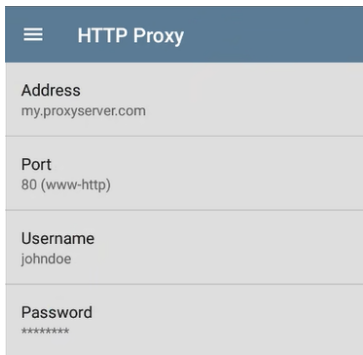

HTTP Proxy	
Address	my.proxyserver.com
Port	80 (www-http)
Username	johndoe
Password	*****

Tap each field to open a pop-up keyboard and enter the appropriate **Address** (you can enter a proxy name or an address), **Port** (set to match the proxy port), **Username**, and **Password**. Tap **OK** to save your entries.

Wi-Fi Profile Test Results

The image below shows a completed AutoTest Wi-Fi Profile.





The screenshot displays the AutoTest application interface. At the top, there is a dark blue header with a hamburger menu icon on the left, the text "AutoTest" in the center, and "START" and a gear icon on the right. Below the header, the main content area shows a list of test results for a Wi-Fi profile named "Connect to The Office Network #1".

- Connect to The Office Network #1**: 7 tests. A green link icon is on the right, and a yellow circle with the number "1" is in the bottom right corner of the item.
- The Office Network #1**: -42 dBm, 130 Mbps, Roams: 0. A green link icon is on the left, and a right-pointing chevron is on the right.
- Channel 6**: 802.11: 36 %, Non-802.11: 5 %. A green bar chart icon is on the left, and a right-pointing chevron is on the right.
- Lnksys:c8b373-05ac3b**: The Office Network #1. A Wi-Fi router icon is on the left, and a right-pointing chevron is on the right.
- DHCP 192.168.0.140**: <1 ms. A green "DHCP" label is on the left, and a right-pointing chevron is on the right.
- DNS cosopendns1.net.com**: 34 ms. A green "DNS" label is on the left, and a right-pointing chevron is on the right.
- 192.168.0.1**: 23 ms, -, 18 ms. A yellow cloud and server icon is on the left, and a right-pointing chevron is on the right.
- PING google**: A green "PING" label is on the left, and a right-pointing chevron is on the right.

A purple circular button with a white plus sign is located in the bottom right corner of the list.

This Profile connects to SSID "The Office Network #1." The Profile is displaying one **Warning** condition from a timeout of the second Gateway ping.

On the Wi-Fi Profile screens, you can perform these actions:

- Tap any of the test result cards, like  Link ,  Channel, or  AP, to open the individual test result screens.
- From any individual test screen, tap the settings icon  to go directly to the settings for the current test.
- On individual test screens, tap [blue underlined links](#) to open a [Wi-Fi](#) app Details screen showing the selected device or ID.
- Tap other **BLUE LINKS** or the action overflow icon  at the bottom of test results screens for additional actions.

NOTE: Blue links and action icons do not appear on every test screen. If the network connection is dropped, you may need to rerun the Profile to re-establish link and enable additional actions.

The individual test cards and screens using the Wi-Fi Profile results for the "LRG" SSID are shown below.

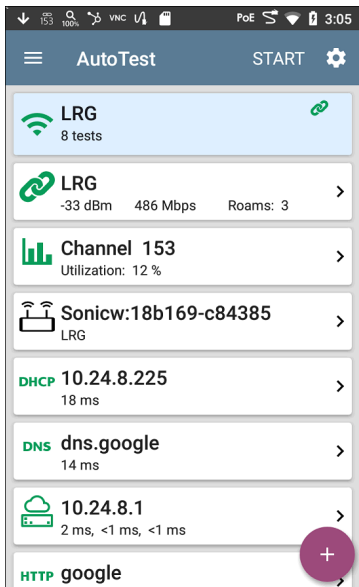

Wi-Fi Link Test Results

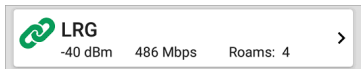

The Wi-Fi link test card indicates whether you can connect to the configured network at your current location. The Wi-Fi Link card displays the SSID, current signal strength (dBm), link speed (Mbps), and number of roams.

Refer to [Wi-Fi Connection Settings](#) if needed.

Tap the card to open the Link test screen.

Wi-Fi Link Test Screen



CoFC-GuestNet

-47 dBm

130 Mbps

Roams: 4

SSID: [CoFC-GuestNet](#)

Security: Open

 Roams: 4

AP: [10.10.0.5](#)

BSSID: [RuckusWi:543d37-299cb8](#)

Channel: 11

 Roam Scans: 1

Last Roam From

AP: [543d372c7ed8](#)

BSSID: [RuckusWi:543d37-2c7ed8](#)

Channel: 11

 Roam Scans: 3

Results

Signal (dBm)



The Wi-Fi Link test screen shows these results:

SSID

Security: Security protocol in use on the network

Roams: Number of times the unit has disconnected from the previous AP and connected to a different AP with a better signal strength. This behavior is partly controlled by the **Roam Threshold** in the [Wi-Fi Connection](#) settings.

AP: Name, IP, or MAC address of the AP to which the Tester is connected, depending on the information EtherScope can see about the AP. This field shows the custom User Name if one has been entered. See [Assigning a Name and Authorization to a Device](#) in the Wi-Fi app chapter.

BSSID: BSSID of the access point

Channel: Channel number on which the AP is operating

Roam Scans: (EXG-200 only) Number of times the EtherScope has scanned for a new AP supporting the same SSID. Multiple triggers may cause EtherScope to scan for another AP, such as low signal strength or high retry rate.

Last Roam From: If the EtherScope has roamed to a new AP, the previous AP's name, BSSID, and Channel display.

AP: AP from which the AP last roamed

BSSID: BSSID of the access point

Channel: Channel number on which the AP is operating

Roam Scans: (EXG-200 only) Number of times the EtherScope has scanned for a new AP supporting the same SSID. Multiple triggers may cause EtherScope to scan for another AP, such as low signal strength or high retry rate.

Wi-Fi Link Trending Graphs

EtherScope's trending graphs operate similarly across different testing apps, allowing you to pan and zoom to view different time intervals. Swipe, double tap, and move the slider to adjust the graph views. See the [Trending Graphs](#) topic for an overview of the controls.

Results

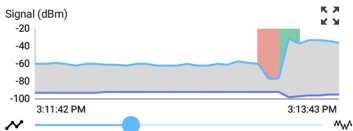

	Cur	Min	Max	Avg
Signal (dBm)	-38	-79	-23	-48
Noise (dBm)	-92	-98	-89	-92
SNR (dB)	54			44



	Cur	Min	Max	Avg
802.11 %	7	1	29	7
Non-802.11 %	2	0	21	3
Total	9			10

The Wi-Fi Link Test graphs save and display data for up to 24 hours in the past if the unit stays linked. The default time interval shown is 2 minutes.

Under each graph, a legend table displays the Current, Minimum, Maximum, and Average measurements. The Current column contains

measurements from the last second. Min, Max, and Avg columns show cumulative measurements.

Signal (dBm) graph: Plots the signal strength in dBm of the connected AP.

- Green vertical bars - The tester roamed to a new AP.
- Red vertical bars - (EXG-200 only) The tester made a roam scan.
- Signal - The AP's signal strength in dBm.
- Noise - The noise level in dBm on the channel used.
- SNR - The network's signal-to-noise ratio in decibels (dB).

Results



	Cur	Min	Max	Avg
Signal (dBm)	-38	-79	-23	-48
Noise (dBm)	-92	-98	-89	-92
SNR (dB)	54			44

Utilization (%) graph: Plots percentage of the connected channel's capacity being used by 802.11 devices and by non-802.11 interference.

- Green vertical bars - The tester roamed to a new AP.
- Red vertical bars - (EXG-200 only) The tester made a roam scan.
- (EXG-200 only) If the **Combine Utilization** setting is enabled in [General Settings](#), the Utilization graph shows only combined 802.11 and non-802.11 channel utilization. See the [General Settings](#) topic for more information.

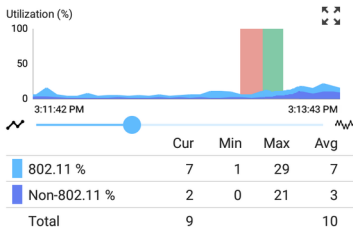

Retries (% of packets) graph: Plots percentage of transmitted packets that are retry packets

- **Retry Rate %** - The percentage of total packets that are retry packets.
- **Retry Pkts** - The number of retry packets seen in the current sample cycle.
- **Total Pkts** - The total number of packets transmitted in the current sample cycle.

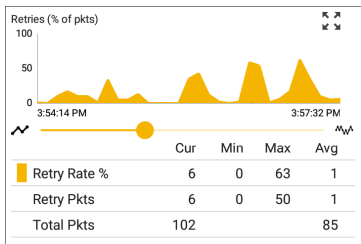

PHY TX Rate (Mbps) graph: Plots the physical transmission rate. The green horizontal dotted line shows the AP's maximum TX rate.

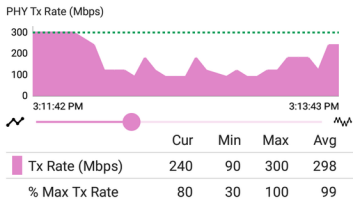

Ping or TCP Connect Response Time graph:

This graph displays on the Link test screen if you run a Ping or TCP Connect test, using the [Ping/TCP](#) app, over the Wi-Fi test port connection while the Profile is linked.

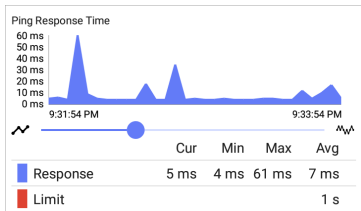

Follow these steps to view the Response Time graph:

1. Tap the blue **PING** hyperlink at the bottom of the Link test screen. This opens the Ping/TCP app with the **Interface** set to Wi-Fi Port and **Protocol** set to Ping.
2. Access and adjust the Ping/TCP settings as desired.
3. **START** the Ping or TCP Connect test.
4. Tap back  to go back to the AutoTest Wi-Fi Link screen. The Response Time graph appears near the bottom of the screen and updates in real time along with the other graphs for the duration of the Ping/TCP test.

Result Codes: Final status of the test (Success or Failure)

Other Actions

Scroll to the bottom of the link test screen to access action links (in blue):

- Tap **PING** to open the **Ping/TCP** app.
- Tap **CONNECT LOG** to view the **Wi-Fi connection log**.
- Tap the action overflow menu icon **•••** to open an additional menu:
 - Tap **Capture** to open the **Capture** app to run a Wi-Fi packet capture on the connected channel and AP.
 - Tap **Upload graphs to Link-Live** upload graphic results to Link-Live. This opens the Link-Live sharing screen.
 1. Use the default file name (which has a <DATE-TIME> format) or tap the Graphs Image Name field to open a touch keyboard to type a custom name.
 2. Tap **SAVE TO UPLOADED FILES** to upload to the Results page  on Link-Live.com.

Connect Log

Connect Log	
4:52:26.734 PM	Wireless: SSID LRG
4:52:27.100 PM	WPA2 Personal
4:52:29.892 PM	Link Down
4:52:29.892 PM	Connecting to AP: 18:b1:69:c8:43:8d Chan 1
4:52:29.893 PM	Send Open Authentication Request
4:52:30.317 PM	Authentication Timeout
4:52:30.319 PM	Connecting to AP: 18:b1:69:c8:43:8d Chan 1
4:52:30.319 PM	Send Open Authentication Request
4:52:30.320 PM	Receive Open Authentication Success
4:52:30.320 PM	Send Association Request
4:52:30.320 PM	Wireless: WPA2 Info Element: Mcast=([4] AES-CCMP) Ucast=([4] AES-CCMP) Auth=([2] PSK)
4:52:30.321 PM	Receive Association Success

The Connect Log shows the Wi-Fi connections, including driver activity, supplicant, and the DHCP process. The Connect Log can be especially helpful for identifying linking or roaming problems.

Select the action overflow icon  at the top right on the Connect Log screen to attach the log to its associated AutoTest result on the [Link-Live](#) website, or attach the Connect Log from the

[floating action menu](#)  on the main Profile screen. See [Wi-Fi Profile FAB](#) below.

Channel Test Results

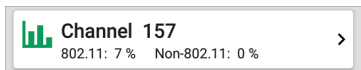

The Channel card shows the channel on which the AP is operating and the current 802.11 and Non-802.11 utilization.

(EXG-200 only) If the **Combine Utilization** setting is enabled in [General Settings](#), the card shows only combined 802.11 and non-802.11 channel utilization. See the [General Settings](#) topic for more information.

Refer to [Channel Test Settings](#) if needed.

Channel Test Screen

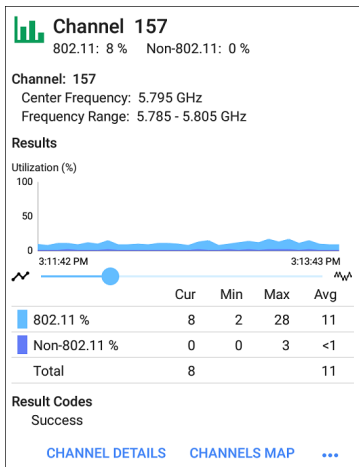

The Channel Test results screen indicates the **Center Frequency** and **Frequency Range** of the connected channel along with a real-time Utilization graph.

Results: The channel Utilization (%) graph updates in real time for as long as the unit is still

connected to the network. The graph saves and displays data for up to 24 hours if the unit stays linked.

To pan and zoom on the graphs, you can swipe, double tap, and move the slider. See the [Trending Graphs](#) topic for an overview of the graph controls.

Utilization (%) graph: Plots percentage of the connected channel's capacity being used by 802.11 devices and by non-802.11 interference.

- **802.11 %:** Percentage of channel capacity being used by 802.11 devices
- **Non-802.11 %:** Percentage of channel capacity being used by non-802.11 interference
- **Utilization:** (EXG-200 only) If the **Combine Utilization** setting is enabled in [General Settings](#), the Utilization graph shows only combined 802.11 and non-802.11 channel utilization.
- **Total:** Total percentage of both 802.11 and non-802.11 channel utilization

Results Codes: Final status of the test (Success or Failure)

Other Actions

Scroll to the bottom of the link test screen to access action links (in blue):

- Tap **CHANNEL DETAILS** to open the Wi-Fi app's **Channels** display.
- Tap **CHANNELS MAP** to open the Wi-Fi app's **Channels Map** display.
- Tap **CAPTURE** to open the **Capture** app to run a Wi-Fi packet capture.

AP (Access Point) Test



The AP card shows the AP's name and the SSID of the network it is supporting. The AP name or address shown is based on what the EtherScope is able to gather from the device and network. If the AP has a **custom user name**, that name is shown on the card and test screen.

The AP test is not graded, so the icon remains black.

AP Test Screen



The screenshot shows the AutoTest app interface. At the top is a dark blue header with a hamburger menu icon on the left, the text "AutoTest" in the center, and a gear icon on the right. Below the header is a white card with a black Wi-Fi router icon and the IP address "10.24.8.29" in large black text, with "LRG" underneath. The card lists the following details: "Device Name: 10.24.8.29" (with the IP as a blue link), "IP Address: 10.24.8.29", "MAC Address: Sonicw:18b169-c84603", "SSID: LRG" (with LRG as a blue link), "Security: WPA2-P", "Roams: 0", "802.11", "Channels: 157, 159", "Type: n", "Supported Types: b, g, n", "Client Associations: 3", and "Roam Scans: 3". At the bottom of the card are three blue links: "CONNECT LOG", "PATH ANALYSIS", and "...".

In addition to the AP name and SSID, the AP test screen shows the following:

Device Name: AP's name or address

IP Address: The AP's assigned IP address. If none could be determined, the field displays dashes --.

MAC Address: The AP's MAC address

SSID: Name of the network on which the AP is operating

Security: Security protocol in use on the network

Roams: Number of times the unit has roamed and connected to a different AP

802.11

Channel(s): Channel or channels the AP is operating on. If the BSSID is on multiple channels, the **bold** channel number indicates the primary channel.

Type: 802.11 type in use on the current link

Supported Types: 802.11 types that the BSSID supports. If none could be determined, the field displays dashes --.

Client Associations: The number of client devices connected to the AP

Roam Scans: (EXG-200 only) Number of times the EtherScope has scanned for a new AP supporting the same SSID. Multiple triggers may cause EtherScope to scan for another AP, such as low signal strength or high retry rate.

Other Actions

Scroll to the bottom of the link test screen to access action links (in blue):

- Tap **CONNECT LOG** to view the [Wi-Fi connection log](#).
- Tap **CAPTURE** to open the [Capture](#) app to run a Wi-Fi packet capture.

DHCP, DNS, and Gateway Results

See [DHCP, DNS, and Gateway Tests](#).

PING FTP TCP HTTP Target Tests

See the [Test Targets](#) topic for information on target test results.

Other Actions (Wi-Fi Profile FAB)

Tap the floating action button (FAB) on the Wi-Fi Profile AutoTest Profile screen to open a floating

menu for additional actions:

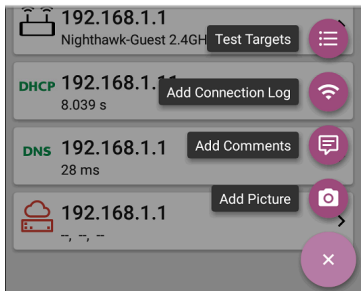

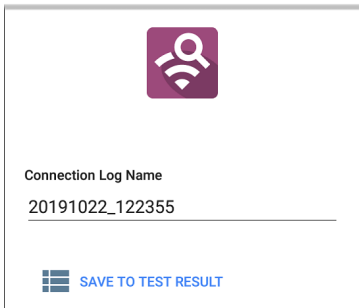

- Tap **Test Targets** to open the [Test Targets](#) screen. You can add Ping, TCP Connect, HTTP, and FTP target tests to the current profile.
- Tap **Add Connection Log** to open a Link-Live sharing screen that allows you to give a custom name to the log file.



1. Use the default file name (which has a <DATE-TIME> format) or tap the text field to enter your desired log name.
 2. Tap **SAVE TO TEST RESULT** to upload the named log file.
- Tap **Add Comments** to open a Link-Live sharing screen where you can add enter comments for the results.
 1. Use the default file name (which has a <DATE-TIME> format) or tap the text field to open a touch keyboard to type a

comment.

2. Tap **SAVE TO LAST TEST RESULT** to upload to the Results page  on [Link-Live.com](https://link-live.com).
- Tap **Add Picture** to open the **Gallery** or **Camera** app to select or take a photo that is then uploaded and attached to your test result.
 1. Use the default file name (which has a <DATE-TIME> format) or tap the Graphs Image Name field to open a touch keyboard to type a custom name.
 2. Tap **SAVE TO UPLOADED FILES** to upload to the Results page  on [Link-Live.com](https://link-live.com).
 - Tap **Add Picture** to open the **Gallery** or **Camera** app to select or take a photo that is then uploaded and attached to your test result.

See the [Link-Live App](#) chapter to learn more about Link-Live and uploading.



Wired AutoTest Profiles

A Wired Profile runs a series of tests over your copper or fiber network connection.

The screenshot shows the AutoTest app interface. At the top, there is a blue header bar with a hamburger menu icon on the left, the text "AutoTest" in the center, and the word "START" followed by a gear icon on the right. Below the header is a list of profile cards. The first card is highlighted in light blue and contains a green wired icon, the text "Wired Profile", and "8 tests" with a green link icon on the right. The following cards are white with a light gray border and each has a right-pointing chevron. The second card has a green lightning bolt icon, "50.6 V", and "Class: 3 13.0 W". The third card has a green link icon, "100M/1G/2.5G/5G/10G", and "RJ-45 HDx/FDx". The fourth card has a keyboard icon, "EXTREME_48", and "Port: 1/37". The fifth card has a green "DHCP" label, "10.250.3.161", and "31 ms". The sixth card has a green "DNS" label, "Compass.netally.eng", and "6 ms". The seventh card has a green cloud and server icon, "COS_DEV_SW1", and "8 ms, 7 ms, 2 ms". The eighth card has a green "HTTP" label and "google". A purple circular button with a white plus sign is overlaid on the bottom right of the list.

AutoTest START

- Wired Profile** 8 tests
- 50.6 V**
Class: 3 13.0 W
- 100M/1G/2.5G/5G/10G**
RJ-45 HDx/FDx
- EXTREME_48**
Port: 1/37
- DHCP 10.250.3.161**
31 ms
- DNS Compass.netally.eng**
6 ms
- COS_DEV_SW1**
8 ms, 7 ms, 2 ms
- HTTP google**

Like the main AutoTest screen, Wired Profile tests are summarized on cards. Tap a card to view individual test screens.

Each test icon (except the switch) displays green, yellow, or red to indicate the status of the completed test step: **Success/Warning/Fail**. The Switch Test card shows the name and port of the nearest switch, but does not turn green to indicate success.

When Wired Profiles Run Automatically







The last enabled Wired Profile in the currently active Profile Group runs automatically when a copper cable is connected or energy is detected to the top RJ-45 port, unless the AutoTest app is open in the foreground and there is more than one enabled Wired Profile. A Wired Profile does not start automatically if **Periodic AutoTest** is running.

After a Wired Profile runs, a wired network link is maintained for further testing. Wired Test Port linkage is indicated in the top **Status Bar** with this notification icon:  .

Wired-Profile-Specific Tests

The following tests are specific to a Wired Profile:

- [PoE](#)
- [Wired Link](#)
- [802.1X](#)
- [VLAN](#)
- [Switch](#)

	Wired Profile 9 tests	
	56.23 V Class: 0 13.00 W	>
	100M/1G/2.5G/5G RJ-45 HDx/FDx	>
	PEAP MSCHAP V2 User: qatest1	>
	Untagged Top: Untagged, 508, 560, 2510, 525, 526, 1	>
	COS-DEV-SW1.NetAlly.com Port: FiveGigabitEthernet1/0/19	>

The 802.1X card only appears if the **802.1X** setting is enabled for the Wired Profile.

The VLAN test card appears if the **VLAN** setting is enabled or if VLAN-tagged traffic is detected during the AutoTest.

- Skip to [Wired Profile Settings](#).
- Skip to [Wired Profile Results](#).
- Skip to [DHCP, DNS, and Gateway Tests](#).
- Skip to [Test Targets](#).

Wired Profile Settings

These settings control the wired test port connection, PoE tests, the thresholds for **Pass/Warning/Fail** results, and any user-added test targets.

Tap the settings icon  on the Wired profile screen, or add a new Wired profile, to configure the profile's settings.

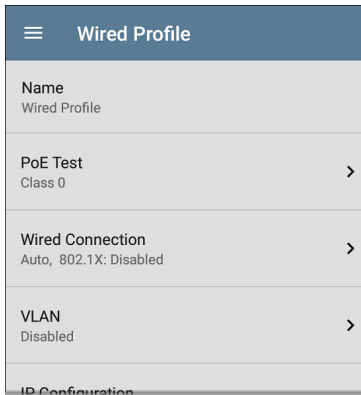

On the **Wired Profile** settings screen, tap each field described below as needed to configure the profile. Changed settings are automatically applied. When you finish configuring, tap the back button  to return to the profile.

Name

Tap the **Name** field to enter a custom name for the profile. This name appears on the main AutoTest screen profile card and the Wired Profile screen header.

PoE Test Settings

Open PoE Test settings to enable or disable PoE and configure the PD Class.

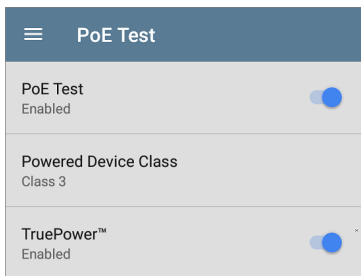

PoE Test

Tap the toggle button to enable or disable the PoE test portion of the current Wired Profile.

Powered Device Class

Tap to select a PoE class setting to match your switch's (or active PoE injector's) available class.

EtherScope supports these classes:

- 802.3af Classes 0-3
- 802.3at PoE+ Class 4
- Cisco's UPOE, which can provide up to 51 W
- 802.3bt Classes 5-8

Select **Passive PoE Injector** if you are using a non-IEEE injector.

NOTE: EtherScope may not receive the total wattage advertised by your switch or injector because of power loss over the cable.

NOTE: EtherScope automatically negotiates Cisco UPOE over LLDP, up to 51 W. LLDP must be enabled on the switch for negotiation to succeed. If the UPOE Class is selected on your EtherScope but LLDP is not

enabled on your Cisco switch, negotiation fails.

LLDP

This toggle button appears if Class 4 (25.50 W) is selected. Enable this setting if LLDP is enabled on the switch you are testing. Class 4 LLDP must be enabled on the switch for AutoTest to detect it successfully. If the LLDP setting is enabled but your switch does not support LLDP, negotiation fails.

Requested Power (W)

This setting appears if **UPOE** is selected in the **Powered Device Class** setting shown above or if the Powered Device Class is set to **Passive PoE Injector** and **TruePower** is enabled. Tap to enter a Requested Power other than the default, if needed. If you tap the backspace button on the pop-up number pad and clear the default value, the valid power range is displayed.

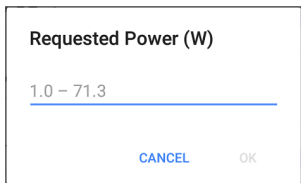

TruePower™

TruePower validates that the Switch (Power Sourcing Equipment) and cabling can provide the requested power under load by applying a load equivalent to the selected class to mimic a Powered Device (PD). Tap the toggle button to enable the TruePower feature.

General Settings that Affect PoE

See the Wired section in [General Settings](#) for descriptions of the **Test PoE before Link** and **Charge Battery via PoE** settings, which also affects the PoE Test and function.

Wired Connection Settings

Open **Wired Connection** settings to configure speed/duplex, link persistence, user-defined

MACs, 802.1X settings, and multi-gigabit SNR threshold.

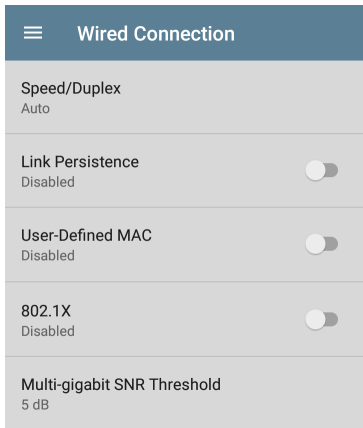

Wired Connection	
Speed/Duplex Auto	
Link Persistence Disabled	<input type="checkbox"/>
User-Defined MAC Disabled	<input type="checkbox"/>
802.1X Disabled	<input type="checkbox"/>
Multi-gigabit SNR Threshold 5 dB	

Speed/Duplex

Tap to select the speed and duplex option that you want to test your network against. The default is Auto negotiation.

When speed is set to Auto, EtherScope auto-negotiates to the highest possible speed/duplex

supported by the link partner. You can select a fixed speed/duplex for the copper interface. For 10 and 100 Mbps you can optionally force the speed and duplex.

This setting does not force the link speed/duplex on the fiber interface, but does control which speed is attempted first when using a multi-rate SFP. As a result, this setting can enable the test unit to connect faster via fiber.

Link Persistence

Link Persistence controls product behavior prior to link and also after link goes down. The default setting for Link Persistence is disabled.

Link Persistence and Establishing Link: When enabled there is no timeout on how long to wait for link to be established. When disabled, the link step fail if not successful in 25 to 30 seconds.

Link Persistence and Link Dropping: When enabled and link drops, the unit attempts to relink. When disabled and link drops, the profile is considered done and no further link attempts are done until a Wired Profile is run again.

User-Defined MAC

This feature can help with tasks such as testing ACL lists (for example, finding out if specific MAC addresses are allowed on the network) or determining if specific IPv4 addresses should be assigned to specific MAC addresses.

1. Tap the toggle field to enable a user-defined MAC for the EtherScope. This displays the current user-defined MAC definition. (If you have not previously provided a definition, the field shows the factory default MAC address.)



2. To enter a new definition, tap the User-Defined MAC definition field, enter a new definition, and then tap **OK**. When enabled, **(User-defined)** appears next to the MAC address on the [About](#) screen and on

relevant test result screens.

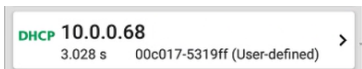

802.1X

Tap the toggle field to enable wired 802.1X authentication in the current Profile. Enabling this setting also enables an [802.1X test card](#) on the Wired AutoTest results screen.

The following settings appear when 802.1X authentication is enabled. Enter all necessary credentials, such as EAP type, username and password, or certificate.

802.1X Enabled	<input checked="" type="checkbox"/>
EAP Type PEAP MSCHAP V2	
Username	
Password	
Alternate ID	

EAP Type

Tap to select a different EAP type if needed. The default is PEAP MSCHAP V2.

Certificate

This setting appears if one of the following EAP types is selected in the setting above: **EAP TLS**, **PEAP TLS**, or **TTLS EAP TLS**.

See [How to Import a Certificate](#).

Username

This field appears along with multiple authentication types. Tap the **Username** field to enter your username.

Password

This field appears along with multiple authentication types. Tap the **Password** field to enter the network password.

Alternate ID

Enter an Alternate ID if necessary. This is an Advanced Authentication setting.

Multi-gigabit SNR Threshold

When a Wired Profile links at speeds higher than 1 Gbps, a table appears on the [Link Test screen](#) showing Multi-gigabit Details. This threshold grades SNR measurements on the four twisted pairs. A Minimum SNR below the selected threshold displays a yellow warning condition. The default is 5 dB. If more than one signal is below the Minimum SNR, the signal with the lowest value is shown.

VLAN Settings



Tap to open the VLAN settings screen. Slide the toggle to the right to enable VLAN testing. Enabling this setting also enables a [VLAN test card](#) on the Wired AutoTest results screen. Once enabled, **VLAN ID** and **VLAN Priority** fields appear. Tap these fields to open a pop-up number pad and enter the correct ID and priority. Tap **OK** to save them.

Wired Profile

- Wait For Network Traffic**
Enabled 
- IP Configuration**
DHCP: Enabled >
- DNS Test**
www.google.com >
- Gateway Test**
Timeout Threshold: 100 ms >
- Test Targets**
1 target(s) >
- Stop After**
All
- HTTP Proxy**
Disabled >

Wait For Network Traffic

Wait for Network Traffic controls whether there is any delay after link comes up before proceeding to the next step. When enabled there

is a delay waiting for packets to be forwarded from the network by the nearest switch. This is useful for switches that are configured to search for networking loops prior to forwarding traffic. On networks with very little traffic, you may choose to disable this delay. The maximum time to delay is 45 seconds.

DHCP, DNS, and Gateway Settings

See [DHCP, DNS, and Gateway Tests](#).

PING FTP TCP HTTP Test Targets

Tap the **Test Targets** field to open the Test Targets screen and add custom Ping, TCP Connect, HTTP, or FTP tests to your AutoTest profile.

See [Test Targets for Wired and Wi-Fi Profiles](#).

Stop After

This setting directs the Wired Profile to stop testing after the selected test step (**Link, Switch, DHCP, DNS, Gateway, or All**). The excluded test cards do not appear on the Profile results screen.

HTTP Proxy

The Proxy control lets you specify a proxy server through which the EtherScope establishes a network connection. In AutoTest, these settings are used when HTTP Proxy is enabled in an [HTTP](#) or [FTP](#) Test Target.

To use the proxy settings with a web browser, run the Profile, and then open the web browser while the unit remains linked.

Open the **HTTP Proxy** screen to enable proxy settings.

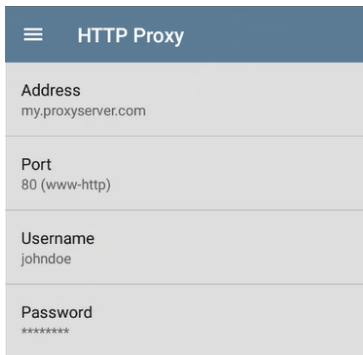

HTTP Proxy	
Address	my.proxyserver.com
Port	80 (www-http)
Username	johndoe
Password	*****

Tap each field to open a pop-up keyboard and enter the appropriate **Address** (you can enter a proxy name or an IPv4 address), **Port** (set to match the proxy port), **Username**, and **Password**. Tap **OK** to save your entries.

Wired Profile Test Results



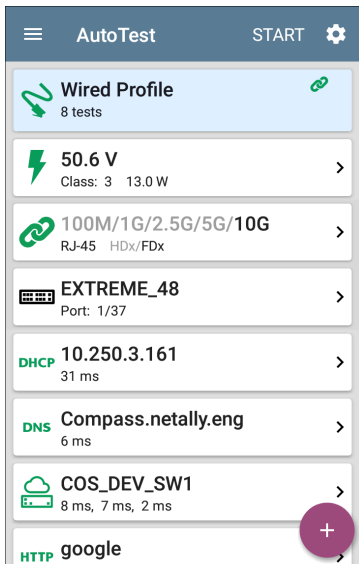

The image below shows a completed AutoTest Wired Profile.



The screenshot displays the AutoTest application interface. At the top, there is a dark blue header with a hamburger menu icon on the left, the text "AutoTest" in the center, and "START" with a gear icon on the right. Below the header is a list of test results for a "Wired Profile" (8 tests). Each result is shown in a white card with a green icon on the left and a right-pointing chevron on the right. A purple circular button with a white plus sign is located at the bottom right of the list.

- Wired Profile** (8 tests)
- 50.6 V** (Class: 3 13.0 W)
- 100M/1G/2.5G/5G/10G** (RJ-45 HDx/FDx)
- EXTREME_48** (Port: 1/37)
- DHCP 10.250.3.161** (31 ms)
- DNS Compass.netally.eng** (6 ms)
- COS_DEV_SW1** (8 ms, 7 ms, 2 ms)
- HTTP google**

On the Wired Profile screens, you can perform these actions:

- Tap any of the test result cards, like  PoE,  Link, or  Switch to open the individual test result screens.
- From any individual test screen, tap the settings icon  to go directly to the settings for the current test.
- On the individual test screens, tap [blue underlined links](#) to open a [Discovery](#) app Details screen showing the selected device or ID.

NOTE: You may need to [Configure SNMP](#) settings in the Discovery app to see all the available information about a network component, such as name and port information.

- Tap other **BLUE LINKS** or the blue action overflow icon  at the bottom of the test results screens for additional actions.

NOTE: Blue links and action icons do not appear on every test results screen, and if the active connection is dropped, you may

need to rerun the Profile to re-establish link and enable additional actions.

PoE Test Results

A rectangular card with a light gray border. On the left side, there is a green lightning bolt icon. To its right, the text "53.1 V" is displayed in a large, bold font. Below this, the text "Class: 0 13.0 W" is shown in a smaller font. On the far right side of the card, there is a right-pointing chevron symbol (>).

	53.1 V	>
	Class: 0 13.0 W	

The card for the Power over Ethernet (PoE) test displays the measured Voltage, Class, and Wattage.

Refer to [PoE Settings](#) if needed.

Tap the card to open the PoE results screen.

PoE Test Results Screen

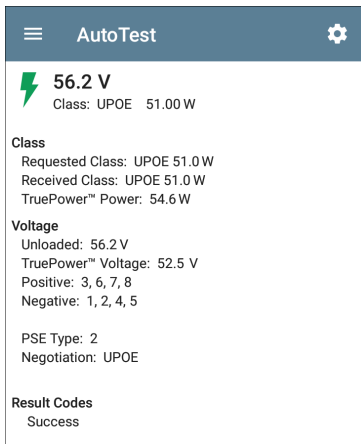

☰ AutoTest ⚙️

 **56.2 V**
Class: UPOE 51.00 W

Class
Requested Class: UPOE 51.0 W
Received Class: UPOE 51.0 W
TruePower™ Power: 54.6 W

Voltage
Unloaded: 56.2 V
TruePower™ Voltage: 52.5 V
Positive: 3, 6, 7, 8
Negative: 1, 2, 4, 5

PSE Type: 2
Negotiation: UPOE

Result Codes
Success

In addition to the information from the PoE card, the PoE test screen shows these results:

Class

Requested Class: Class selected in the PoE test settings

Received Class: Class acknowledgment received from the switch

TruePower™ Power: Measured wattage with load.

NOTE: The PoE card displays additional TruePower™ results only if TruePower is enabled in the Wired Profile [PoE Settings](#).

Voltage

Unloaded: Measured voltage without load

TruePower™ Voltage: Measured voltage with load

Positive: Positive PoE cable pair IDs

Negative: Negative PoE cable pair IDs

PSE Type: Switch's advertised Power Sourcing Equipment (PSE) type. Recognized types are 1 – 4, LTPoE++, Cisco UPOE, and PoE Injectors. PSE supporting UPOE are classified under Type 2. If the type cannot be determined, "1/2" is displayed.

Negotiation: Negotiation status for UPOE and Class 4 (UPOE or LLDP)

Result Codes: Final status of the test (Success or Failure)

Wired Link Test Results

The Wired Link card indicates whether you can connect to an active network switch.

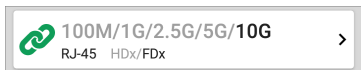

The Link test card for a copper Ethernet connection displays the advertised speed and duplex capabilities in **gray text** and the detected speed and duplex in **black text**.

EtherScope can test and display information for link speeds up to 10G.



For a Fiber connection, the Link test card shows the connection speed and duplex.

The link icon turns yellow  (displays a Warning) under the following conditions:

- EtherScope has linked at a speed slower than the maximum advertised speed.
- The link is using half duplex.
- For links faster than 1G, EtherScope has detected a minimum SNR value below the set threshold.

Tap the card to open the Link test screen.

Wired Link Test Screen



AutoTest



100M/1G/2.5G/5G/10G

RJ-45 FDX

Speed

Advertised Speeds: 100M/1G/2.5G/5G/10G

Actual Speed: 10G

Duplex

Advertised Duplex: FDX

Actual Duplex: FDX

RJ-45 Details

Rx Pair: All

Multi-Gigabit Details

Channel	Delay Skew	SNR	Avg SNR
A	REF	8.8 dB	8.7 dB
B	-1.25 ns	6.7 dB	6.8 dB
C	-3.75 ns	5.9 dB	5.9 dB
D	-1.25 ns	8.9 dB	8.7 dB
Threshold			1 dB

Result Codes

Success

The Wired Link test screen shows the following:

Speed

Advertised Speed: Speed capability as reported by the switch

Actual Speed: Link speed as measured by EtherScope nXG

Duplex

Advertised Duplex: Duplex capabilities reported by the switch

Actual Duplex: Duplex in use as detected by EtherScope

RJ-45 Details (Copper)

Rx Pair: Link receive pair

Multi-Gigabit Details (Copper)

This table appears only when the Wired Profile is linked at speeds higher than 1G. Each twisted pair channel is graded based on the minimum SNR observed. Data in the table updates each second as long as the link persists.

Channel: Channels A, B, C, and D representing the twisted pairs in the cable

Delay Skew: Difference in propagation delay between sets of wired pairs. Channel A acts as the reference for the other channel measurements.

SNR: Current signal-to-noise ratio on each channel

Avg SNR: The average SNR measurement since link was established

Threshold: Multi-Gigabit SNR Threshold from the [Wired Connection settings](#)

SFP Details (Fiber)

**1G**

SFP FDx

Speed

Advertised Speeds: 1G

Actual Speed: 1G

Duplex

Advertised Duplex: FDx

Actual Duplex: FDx

SFP Details

Wavelength: 850 nm

Temperature: 42 C

Voltage: 3.29 V

Tx Bias Current: 5.99 mA

Tx Power: -4.42 dBm

Rx Power: -7.67 dBm

Reference Power: -7.67 dBm

Power Difference: 0 dB

Result Codes

Success

[SET REFERENCE](#)[CLEAR REFERENCE](#)

The SFP Details are defined as follows:

Wavelength: Wavelength (in nanometers) at which the fiber connection is operating

Temperature: Temperature in degrees Celsius

Voltage: SFP transceiver power supply voltage (~3.3 V)

Tx Bias Current: Transmitter bias current

Tx Power: Transmitter power

Rx Power: Link receiver power

Reference Power: The user can set a Reference Power by pressing the **SET REFERENCE** button. This sets the current Rx Power as the reference. The value is saved until cleared by the **CLEAR REFERENCE** button. (The value is saved across reboots.)

Power Difference: The difference between the current Rx Power and the reference. The number is positive if the current value is greater than the reference value.

Results Codes: Final status of the test (Success or Failure)

802.1X Test Results

The 802.1X test card only displays if the **802.1X setting** is enabled in the Wired Profile Settings.



The card shows the EAP type selected in the Wired Connection settings and the username or certificate used. The 802.1X icon turns green if the connection is successful and yellow if 802.1X authentication fails.

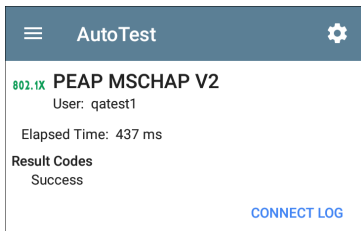

802.1X Test Screen



The 802.1X screen also shows the time it took for the authentication process to complete along with Result Codes.

Tap the blue **CONNECT LOG** link to view the 802.1X Connect Log.

Connect Log		Save to Link-Live
3:59:45.654 PM	Supplicant: PEAP_MSCHAP_V2	
3:59:45.775 PM	Received EAP Fail	
3:59:45.777 PM	Identity: qatest1	
3:59:45.781 PM	Identity: qatest1	
3:59:45.808 PM	NAK: GOT (4) EAP-MD5 WANT (25) EAP-Peap	
3:59:45.822 PM	PEAP: Selecting Version: 0	
3:59:45.824 PM	PEAP: Received EAP Start request, sending Client Hello	
3:59:45.851 PM	PEAP: Received Server Hello	
3:59:45.923 PM	PEAP: Server Certificate unverified:	

Select the action overflow icon  at the top right on the Connect Log screen to attach the log to its associated AutoTest result on the [Link-Live](#) website. You can also attach the Connect Log from the [floating action menu](#)  on the main Wired Profile screen.

VLAN Test Results

The VLAN card only displays if the [VLAN setting](#) is enabled in the Wired Profile Settings or if AutoTest detects VLAN-tagged traffic.

VLAN 508, Best Effort (0)	
Top: Untagged	

The top line on the VLAN test card shows the configured VLAN settings (image above) or "Untagged" (image below) if VLAN disabled but VLAN-tagged traffic is seen.

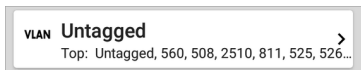

Untagged indicates that no VLAN tag is present in either received or transmitted frames, also referred to as the Native VLAN.

The second line on the VLAN card displays the top VLANs with the most detected traffic.

Tap the card to open the full VLAN screen.

VLAN Test Screen

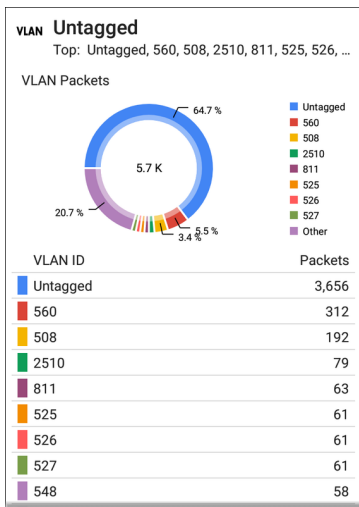

The VLAN test screen displays the real-time traffic the EtherScope detects on the top VLANs. Up to nine VLANs with the highest traffic are displayed as colored portions of the pie chart.

The table on the lower part of the VLAN screen lists all the VLANs seen.

Switch Test Results

The results available for the Switch Test are based on Discovery Protocol advertisements and SNMP system group information. SNMP forwarding table data is used to determine the Nearest Switch. See [Discovery Settings](#) for [SNMP configuration](#) instructions.



The Switch test card displays the Nearest Switch and the port name. The Switch icon remains black if the test is successful.

- If the EtherScope does not detect any network traffic moving through the switch after 45 seconds, the switch icon turns yellow.



- If the connection is lost while the Wired Autotest is running, the switch icon turns red.



- If the EtherScope was unable to identify the nearest switch, "Nearest Switch Not Found" displays on the Switch card.



The EtherScope continues to search for the nearest switch, even after the AutoTest completes.

Tap the Switch card to open the full switch results screen.

Switch Test Results Screen

Information on the Switch Test screen is organized by the order in which it was received, either via Discovery Protocol advertisements or SNMP.

**COS-DEV-SW1.NetAlly.com**

Port: Fi1/0/42

Status:

Network traffic seen in 196 ms from
NetAlly:00c017-53009d

Nearest Switch: [COS-DEV-SW1.NetAlly.com](#)

Port: Fi1/0/42

Description: Test Port

VLAN ID: 500

Voice VLAN ID: 3333

IP Address: 10.250.0.2

MAC Address: Cisco:7802b1-b0caaa

Location: COS-DEV Lab Rack S2

Contact: Erik

Model: cisco C9300-48UN

Type: CDP (First Seen)

Last Seen: 3:39:11 PM

Switch: [COS-DEV-SW1.NetAlly.com](#)

Port: Fi1/0/42

Description: Test Port

VLAN ID: 500

IP Address: 10.250.0.2

MAC Address: Cisco:7802b1-b0ca80

Model: Cisco IOS Software [Fuji], Catalyst L3 Switch
Software (CAT9K_IOSXE), Version 16.9.3,

Type: LLDP

Last Seen: 3:39:12 PM

Each section represents a unique port advertisement as defined by protocol type and MAC address.

The switch results screen shows the following data fields:

Status: Time elapsed after link was established before network traffic was received from the switch. The MAC address of the device that sent the packet is also shown.

Nearest Switch: Name of the switch determined to be closest to the EtherScope

Port: Detected Port name

Description: Configured description reported by the switch

VLAN ID: VLAN ID number (if present)

Voice VLAN ID: Voice VLAN ID number (if present)

IP and MAC Addresses: Discovered switch addresses

Location: Configured location reported by the switch. This field only appears if the EtherScope has SNMP access to the Nearest Switch.

Contact: Configured contact person reported by the switch. This field only appears if the

EtherScope has SNMP access to the Nearest Switch.

Model: Switch model name and/or number

Type: Discovery Protocol - CDP, LLDP, EDP, FDP, or SNMP. (First Seen) displays next to the protocol type first seen by the EtherScope.

Last Seen: For non-SNMP discovery protocols (CDP, LLDP, EDP, or FDP), the time the advertisement was last received by the EtherScope

Last Updated: For SNMP only, the time the information was gathered from SNMP tables

SNMP information, if available, appears at the bottom of the screen once the discovery process has acquired relevant data.

Software (CAT9K_IOSXE), Version 16.9.3,
Type: LLDP
Last Seen: 3:39:12 PM

Switch: [COS-DEV-SW1.NetAlly.com](#)

Port: Fi1/0/42
Description: Test Port
VLAN ID: 500
IP Address: 10.250.0.1
MAC Address: Cisco:00000c-07ac01
Model: CAT9K_IOSXE
Type: SNMP
Last Updated: 3:39:05 PM

[INTERFACE DETAILS](#) [BROWSE](#) ...

Switch: The Nearest Switch is listed at the top of this section. Other switches seen via advertisements or SNMP are listed below.

Additional Actions

Tap the blue links at the bottom of the switch test results screen to open other apps or tools for the target.

- Tap [INTERFACE DETAILS](#) to open the Interface Details screen for the Switch Port in the [Discovery](#) app.

NOTE: The **Interface Details** action link only appears in the Switch results if

EtherScope has current [Discovery](#) data, and AutoTest identified the nearest switch and connected interface.

- Tap **PING** to open the Ping test screen for the switch.
- Tap the action overflow menu icon **...** to open an additional menu:

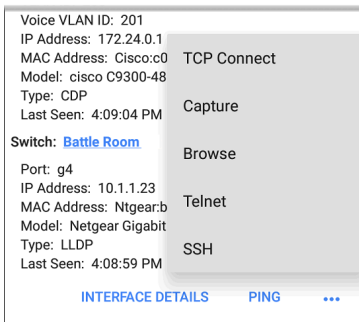

- Tap **TCP Connect** to open the corresponding NetAlly apps, populated with the switch's address.

- Tap **Capture** to open the [Capture](#) app to run a packet capture on the target.
- Tap **Browse** to open the Chromium browser pointed to the switch IP address.
- Tap **Telnet** to open a [Telnet](#) session for the switch IP address.
- Tap **SSH** to open a [SSH](#) session for the switch IP address.

DHCP, DNS, and Gateway Results

Results for these tests operate the same in both Wired and Wi-Fi profiles.

See [DHCP, DNS, and Gateway Tests](#)

PING FTP TCP HTTP Target Tests

See the [Test Targets](#) topic for information on target test results.

Wired Profile FAB

The floating action button (FAB) on AutoTest Profile screens allows you to add Test Targets to the Profile, as well as attach comments, an

image, and an 802.1X connect log to this AutoTest result on the [Link-Live](#) website.

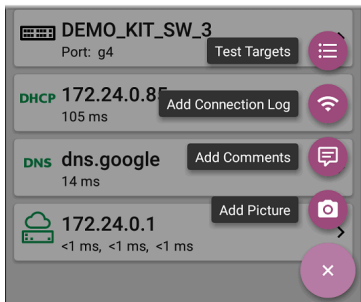

- The **Test Targets** option opens the [Test Targets](#) screen, where you can add Ping, TCP Connect, HTTP, and FTP target tests to the current profile.
- **Add Connection Log** opens a Link-Live sharing screen that allows you to custom name the log file before saving to the test result.



Connection Log Name
20191022_122355

 **SAVE TO TEST RESULT**

Tap the field to enter your desired log name, and tap **SAVE TO TEST RESULT** to upload.

- **Add Comments** also opens a Link-Live [sharing](#) screen where you can enter comments.

Comment

Conference Room

Job Comment

North Office

 **SAVE TO TEST RESULT**

Tap the fields to enter your desired comments, and tap **SAVE TO LAST TEST RESULT** to upload them.

- The **Add Picture** function lets you open the **Gallery** or **Camera** app to select or take a photo that is then uploaded and attached to your test result.

See the [Link-Live App](#) chapter to learn about Link-Live and uploading.

DHCP, DNS, and Gateway Tests

DHCP	10.250.2.168	>
	<1 ms	
DNS	Compass	>
	16 ms	
	10.250.0.1	>
	2 ms, 2 ms, 4 ms	

These tests are included in both [Wired](#) and [Wi-Fi](#) AutoTest Profiles. The settings and results fields are the same for each Profile type.

Access AutoTest's DHCP, DNS, and Gateway tests from either the Wired or Wi-Fi Profile settings screens, or by tapping the settings button  from the full results screen for each test type.



Tap [blue links](#) or the blue action overflow icon  on the test results screens for additional actions.

DHCP or Static IP Test

The DHCP (Dynamic Host Configuration Protocol) test indicates whether the EtherScope receives an IP address assignment from the DHCP server.

DHCP Settings – IP Configuration

To open the IP Configuration screen, either:

- Open a Wired or Wi-Fi Profile, tap the DHCP summary card, and then tap the settings button  on the DHCP test results screen.
- Tap the main menu icon , select **AutoTest Settings**, open a Wired or Wi-Fi Profile, and then tap **IP Configuration**.

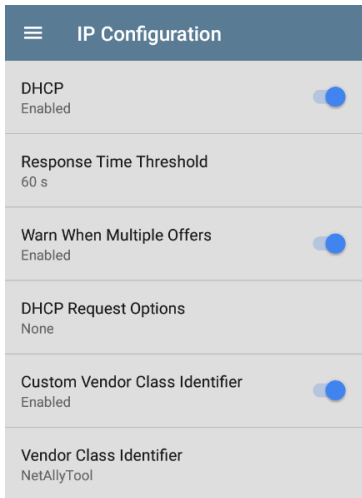

DHCP

DHCP is enabled by default. Tap the toggle button to disable DHCP and enter static IP addresses, as described below.

Response Time Threshold

(Appears only if DHCP is enabled.) Tap this field to select a value or enter a custom value to set how long the EtherScope waits for a DHCP server response before failing the DHCP test.

Warn When Multiple Offers

(Appears only if DHCP is enabled.) Depending on how your network is configured, multiple DHCP offers may or may not be a problem. Tap this field to toggle whether AutoTest creates a warning if multiple offers are received.

DHCP Request Options

(Appears only if DHCP is enabled.) Tap this field to open a dialog to select one or more DHCP request options.

Custom Vendor Class Identifier

Custom Vendor Class Identifier is disabled by default. Tap the toggle button to enable the Vendor Class Identifier field, as described below.

Vendor Class Identifier

(Appears only if Custom Vendor Class Identifier is enabled.) Tap this field to type the vendor class identifier.

Static IP Address

IP Configuration	
DHCP Disabled	<input type="checkbox"/>
Static IP Address	
Subnet Mask 255.255.255.0 /24	
Default Gateway 192.168.1.1	
Primary DNS Server 8.8.8.8	
Secondary DNS Server	

The Static IP address fields for **Subnet Mask**, **Default Gateway**, and **Primary** and **Secondary DNS Servers** only appear if DHCP is disabled. Tap each field to open a pop-up number pad and enter the static addresses as needed. Tap **OK** to save your entries.

DHCP Test Results



When DHCP is enabled, the DHCP test card and results screen are displayed in the Profile.



The DHCP Test card displays the DHCP server's IP address and the total time for the discover, offer, request, and acknowledgment to complete.

Tap the card to open the DHCP test screen.

NOTE: (User-defined) appears next to the MAC address beneath the DHCP IP address on the results screen when a User-Defined MAC is enabled for this connection in [General Settings](#) or in the AutoTest profile.

 **AutoTest** 

DHCP 192.168.1.32
736 ms 60c017-530234 (User-defined)

Device Name: [Mike's home AP](#)

IPv4 Address: 192.168.1.1

DHCP Test Results Screen

DHCP 10.250.2.168

<1 ms

Device Name: [COS_DEV_SW1](#)

IPv4 Address: 10.250.0.2

MAC Address: Cisco:001cb1-da2cc6

Results

Offered: 10.250.2.168

Accepted: 10.250.2.168

Subnet Mask: 255.255.252.0

Subnet: 10.250.0.0/22

Lease Time: 1 day 0 seconds

Expires: 4/26 2:39 PM

Relay Agent: --

Metric	Result
 Offer	<1 ms
 Acknowledge	<1 ms
Total Time	<1 ms
Threshold	60 s

End User Response Time

50.0 %  Offer Acknowledge

Device Name: The discovered name of the DHCP Server, or, if no name could be discovered, the IP address

IPv4 Address: IP address of the server

MAC Address: Server's MAC address. Two dashes -- indicate that no MAC address was provided from the server.

Results

Offered: IP address offered by the DHCP server

Accepted: IP address accepted by the EtherScope

Subnet Mask: Used to determine which addresses are local and which must be reached via a gateway

Subnet: Combination of the subnet mask and the offered IP address

Lease Time: The amount of time the IP address is leased to the EtherScope by the DHCP server

Expires: Expiration date and time of the IP address

Relay Agent: If a BOOTP DHCP relay agent is present, this field shows its IP address. The relay agent relays DHCP messages between

DHCP clients and DHCP servers on different IP networks.

End User Response Time table and chart: Breakdown of the times for the process of acquiring a DHCP IP address

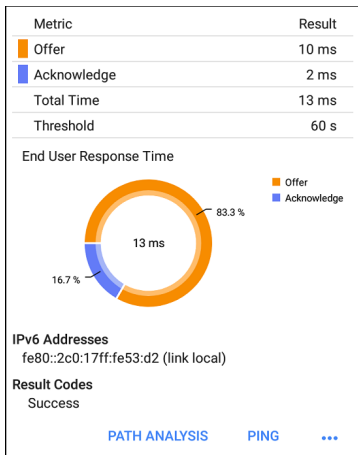

Offer: Time between when the EtherScope sent the discovery and received an address offer from the DHCP server

Acknowledge: Time between EtherScope sending the request and receiving the acknowledgment from the DHCP server

Total Time: Total amount of time consumed by the DHCP process

Threshold: The DHCP Response Time Threshold from the DHCP test settings, which controls how long the EtherScope waits for a DHCP server response before failing the DHCP test.

End User Response Time: A pie chart showing the Offer and Acknowledgment times as percentages

IPv6 Addresses: Addresses obtained via router advertisement

Results Codes: Final status of the test (Success or Failure)

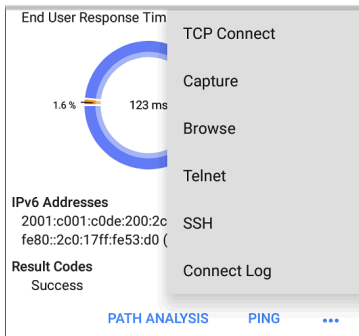

The additional actions available on the DHCP test screen include opening the [Path Analysis](#), [Ping/TCP](#), or [Capture](#) apps populated with the DHCP server address, browsing to the IPv4 address in the web browser, starting a [Telnet](#) or [SSH](#) session, or viewing the [Connect Log](#).

Static IP Test Results

If DHCP is disabled, the DHCP test becomes a "Static IP" test and the Subnet and addresses that were entered in the DHCP test settings are displayed.

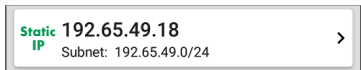

The Static IP card displays the configured IP and Subnet addresses.

Tap the card to open the test results screen.

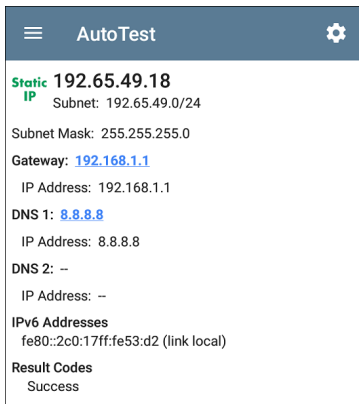

The Static IP test screen displays the configured addresses.

Subnet: Combination of the subnet mask and the offered IP address

Subnet Mask: Used to determine which addresses are local and which must be reached via a gateway

Gateway: Resolved hostname of the Gateway or its IP address if no name could be discovered

IP Address: IP address of the Gateway

DNS (1 and 2): Names and IP addresses of Primary and Secondary DNS servers

IPv6 Addresses: Addresses obtained via router advertisement

Results Codes: Final status of the test (Success or Failure)

Duplicate IP Address

The DHCP and Static IP tests also detect and report the presence of a device using the same IP address (duplicate IP). If the configured address is in use, the AutoTest fails.

● IP Address In Use By: [BRW2C6FC94A974E](#)

MAC Address: HonHai:2c6fc9-4a974e

IPv6 Addresses

fe80::2c0:17ff:fe53:d2 (link local)

Result Codes

IP address already in use (11)

IP Address In Use By: Shows the name of the device currently using the configured static IP address. Tap the blue underlined link to open a [Discovery Details screen](#) for the device.

MAC Address: MAC of the device using the IP address

DNS Test

For overview information, see [DHCP, DNS, and Gateway Tests](#).

The DNS (Domain Name System) server test checks the performance of DNS servers resolving the specified URL. The EtherScope obtains DNS addresses through DHCP or static address configuration.

DNS Test Settings

☰ DNS Test

DNS Test
Enabled

Lookup Name
www.google.com

IP Protocol Version
IPv4

Lookup Time Threshold
1 s

Reverse Grading
Disabled

DNS Test

To disable the DNS test in your current AutoTest, tap the top field on the this screen to set it to Disabled. The DNS card still appears on the main AutoTest results screen so that you can still see the addresses of the DNS servers. However, the

following lookup values are set to "--", and the Result Code is set to "Test is disabled".

Lookup Name

This is the URL the DNS server(s) attempts to resolve. Tap the field to enter a URL other than the default: `www.google.com`.

IP Protocol Version

Tap the field to switch between IPv4 and IPv6.

Lookup Time Threshold

This threshold controls how long the EtherScope waits for a response from the DNS server(s) before the test is failed. The default is 1 second. Tap the field to select or enter a new threshold.

Reverse Grading

When Reverse Grading is enabled, a test is considered successful if it fails and a failure if it succeeds. The Results Codes section of the results screen includes the message "Grading has been reversed".

DNS Test Results

The server name and lookup time for DNS 1 are shown on the DNS test card.

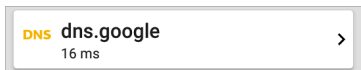

Tap the card to open the DNS test results screen.

DNS Test Results Screen

DNS dns.google
16 ms

Lookup Name: www.google.com

Threshold: 1 s

DNS 1: [dns.google](#)

Lookup IP: 216.58.193.68
Lookup Time: 16 ms

DNS 2: [dns.google](#)

Lookup IP: --
Lookup Time: -- ●

Result Codes

1: Success
2: Timeout error (3)

[TEST AGAIN](#) [PATH ANALYSIS](#) ...

Lookup Name: Name resolved by the DNS servers

Threshold: Lookup Time Threshold from the DNS test settings

DNS #: Name of the listed DNS server

Lookup IP: Resolved IP address

Lookup Time: Time to receive the IP address after the lookup request sent

Results Codes: Final status of the test (Success or Failure) for each DNS server

14 ms

Lookup Name: www.google.com

Threshold: 1 s

DNS 1: [dns.google](#)

Lookup IP: 172.217.11.100

Lookup Time: 14 ms

DNS 2: [dns.google](#)

Lookup IP: 172.217.11.100

Lookup Time: 14 ms

Result Codes

1: Success

2: Success

TEST AGAIN PATH ANALYSIS ...

Tap [blue links](#) or the blue action overflow icon **...** at the bottom of the test results screens to run the **DNS Test Again**, open another app

populated with the name and IP address of DNS 1, or **Browse** to the Primary DNS server in your web browser.



Gateway Test

For overview information, see [DHCP, DNS, and Gateway Tests](#).

This test indicates whether the default Gateway could be successfully pinged and identifies the address of the current IPv4 and IPv6 routers.

Gateway Test Settings

A screenshot of the 'Gateway Test' settings screen. The screen has a dark blue header with a hamburger menu icon and the title 'Gateway Test'. Below the header are three settings rows. The first row is 'Gateway Test' with a blue toggle switch and the text 'Enabled'. The second row is 'Timeout Threshold' with the value '100 ms'. The third row is 'Reverse Grading' with a grey toggle switch and the text 'Disabled'.

Gateway Test	
Gateway Test Enabled	<input checked="" type="checkbox"/>
Timeout Threshold 100 ms	
Reverse Grading Disabled	<input type="checkbox"/>

Gateway Test

To disable the Gateway test in your current AutoTest, tap the top field on the this screen to set it to Disabled. The Gateway card still appears on the main AutoTest results screen so that you can still see the addresses of the Gateway servers. However, the following lookup values are set to "--", and the Result Code is set to "Test is disabled".

Timeout Threshold

Indicates how long the EtherScope waits for a response from the gateway before grading the test as a fail. Tap the field to select one of the value options, or enter a custom value.

Reverse Grading

When Reverse Grading is enabled, a test is considered successful if it fails and a failure if it succeeds. The Results Codes section of the results screen includes the message "Grading has been reversed".

Gateway Test Results

EtherScope gets the Gateway's IP address from DHCP or the static IP configuration, and uses SNMP to acquire system group information and statistics for the port that services the EtherScope's subnet. See [Discovery Settings](#) for information about [SNMP configuration](#).



The Gateway test card shows the gateway's IP address and the three Ping response times.

Gateway Test Results Screen



The screenshot shows the AutoTest app interface. At the top is a dark blue header with a hamburger menu icon on the left, the text "AutoTest" in the center, and a gear icon on the right. Below the header is a white card with a green cloud icon and a server rack icon. The card displays the following information:

- COS_DEV_SW1**
2 ms, 2 ms, 3 ms
- IPv4 Gateway Name:** [COS_DEV_SW1](#)
- IPv4 Address: 10.250.0.1
- MAC Address: Cisco:00000c-07ac01
- IPv6 Gateway Name:** [Andromeda Automation Procurve](#)
- Protocols:** RIP, OSPF, HSRP, Statically Configured Router, Proxy ARP Agent, Virtual Router (HSRP)
- Ping Results**
Response Times: 2 ms, 2 ms, 3 ms
Threshold: 100 ms
- Result Codes**
1: Success
2: Success
3: Success

At the bottom of the card are three blue buttons: "TEST AGAIN", "PATH ANALYSIS", and "...".

IPv4 Gateway Name: Resolved hostname of the Gateway or its IP address if no name could be discovered

IPv4 Address: Internal IPv4 address of the Gateway

MAC Address: Server's MAC address. Two dashes -- indicate that no MAC address was provided from the server.

IPv6 Address: Router's IPv6 address (if available)

IPv6 Gateway Name: Name advertised by the IPv6 router (if available)

Protocols: Routing protocols the EtherScope used to obtain the Gateway data

Ping Results

- **Response Times** from the three Pings sent to the gateway
- **Threshold:** Gateway Timeout Threshold configured in the gateway settings

Results Codes: Final status of the test (Success or Failure) for each of the three Gateway Pings

 **COS-IT-SW1.netally.com**
1 ms, 1 ms, 1 ms

Gateway Name: [COS-IT-S](#)

IPv4 Address: 172.24.0
MAC Address: Cisco:6c
IPv6 Address: --

Protocols: Statically Cont

Ping Results
Response Times: 1 ms,
Threshold: 100 ms

Result Codes
1: Success
2: Success
3: Success

Ping
TCP Connect
Capture
Browse
Telnet
SSH

[TEST AGAIN](#) [PATH ANALYSIS](#) [...](#)

Tap [blue links](#) or the blue action overflow icon [...](#) at the bottom of the test results screens to run the Gateway **TEST AGAIN**, open another app, **Browse** to the Gateway's IPv4 Address, or start a [Telnet](#) or [SSH](#) session to the Gateway.

Test Targets for Wired and Wi-Fi AutoTest

PING	google	>
	28 ms, 28 ms, 15 ms	
TCP	NetAlly	>
	80 ms, 76 ms, 82 ms	
HTTP	github	>
	1.114 s	
FTP	Asset Server	>
	246 ms	

AutoTest Target tests are user-assignable endpoints to which EtherScope nXG attempts to connect each time the AutoTest profile runs. These tests ensure availability of internal or external websites, servers, and devices to users of your network.

Tap a link below to go to the test's topic:



[Ping](#)

[TCP Connect](#)

[HTTP](#)

[FTP](#)

Adding and Managing Test Targets

To add test targets to AutoTest profiles and manage your saved targets, open the **Test Targets** screen from either the **Wired** or **Wi-Fi Profile Settings**  or by tapping the FAB  on the **Wired** or **Wi-Fi Profile** results screens.

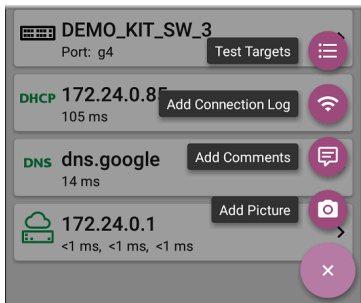

The Test Targets screen lists all of the defined and saved Test Targets. Checked boxes indicate the targets enabled in the current Profile. (Test Targets can be added to and used in any number of Wired or Wi-Fi Profiles.)

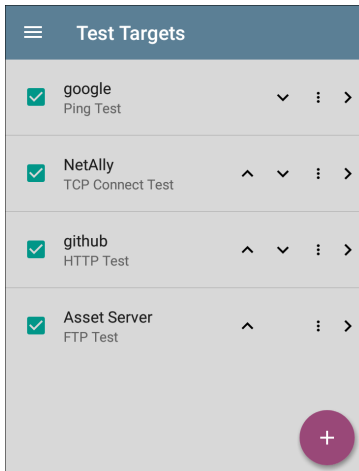

On the Test Targets screen, you can perform these actions:

- Select the checkboxes for each Target you want to include in the current profile.
- Tap the up and down arrows to reorder the saved Test Targets on this screen and the

main AutoTest Profile screen.

- Tap the action overflow icon  to **Duplicate** or **Delete** a target test.

CAUTION: When you delete a Test Target, you delete it from all Profiles. To remove a Test Target from the current profile, simply uncheck it.

- Tap the **FAB** icon  to add a new target test: Ping, TCP Connect, HTTP, or FTP.

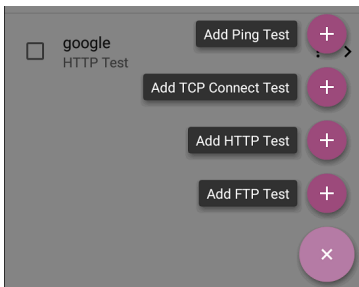

- Tap any target test name to open that test's settings. You can then enter a custom test name, target address, or thresholds. For

more information on settings, see:

- [Ping Test](#)
- [TCP Connect Test](#)
- [HTTP Test](#)
- [FTP Test](#)

Target Test Results Screens

The Target Test type icons display green, yellow, or red to indicate the status (or grade) of the completed test portions: **Success/Warning/Fail**.

As an example, in the Ping test image below, the entire Ping test is graded with a Warning because the third Ping was not returned within the Timeout Threshold configured in the settings.

PING google

9 ms, 33 ms, --

Device Name: [172.217.1.196](#)

IPv4 Address: 172.217.1.196

MAC Address: --

Results

Lookup Time: 3 ms

Response Times: 9 ms, 33 ms, -- ●

Threshold: 250 ms

Result Codes

1: Success

2: Success

3: Timeout error (3)

The third Response Time displays two dashes -- to indicate that no response was received, and under the Results heading, the yellow dot points out the third Response Time as the reason for the Warning. Additionally, the third Result Code lists "Timeout error" as the reason for the Warning.

Additional Target Test Actions

[TEST AGAIN](#)[PATH ANALYSIS](#)

After the Target test has completed, tap any of the blue links to perform additional actions, including opening other testing apps.

- Tap the blue linked Device Name to open a [Discovery](#) Details app screen for the selected device. From there, you can open other apps and run additional tests.
- Tap [TEST AGAIN](#) to run just the target test again.
- Tap [PATH ANALYSIS](#) to open the [Path Analysis](#) to app with the path destination configured with the current target.
- Tap the action overflow icon  to open the listed apps or tools with the target pre-populated, for example:
 - **Ping** or **TCP Connect** to open the [Ping/TCP](#) app with the current target address.
 - [Capture](#) traffic from the test target.
 - Browse to the target URL on the internet with your [web browser](#) app.

- **Telnet** or **SSH** to open the [Telnet/SSH tools](#) with the current target address.

AutoTest Ping Test

A Ping test sends an ICMP echo request to the selected target to determine whether the server or client can be reached and how long it takes to respond. The AutoTest Target Ping Test sends three Pings to the target and reports the response times. The target can be an IPv4 address, IPv6 address, or named server (URL or DNS).

Ping Test Settings

Ping Test	
Name	google
Device Name	www.google.com
IP Protocol Version	IPv4
Frame Size (bytes)	64
Do Not Fragment	<input type="checkbox"/>
Timeout Threshold	1 s
Reverse Grading	<input type="checkbox"/>

Name

This field allows you to assign a custom name to the test. The name appears on the target test card in the profile.

Device Name

Enter the IP address or URL of the target device. If you enter an IP address, the DNS lookup portion of the test is skipped.

IP Protocol Version

IPv4 is used by default. Tap the field to switch between IPv4 and IPv6.

Frame Size (bytes)

This setting specifies the total size of the payload and the header sent. Valid sizes are 64 bytes to 1518 bytes. To test the Maximum Transmission Unit (MTU) along a route to a target, select the MTU frame size you want to test, and set **Do Not Fragment** to **Enabled**.

Do Not Fragment

Tap the toggle button to enable.

Timeout Threshold

This threshold controls how long the EtherScope waits for a response from the target before failing the test.

Reverse Grading

When Reverse Grading is enabled, a test is considered successful if it fails and a failure if it succeeds. The Results Codes section of the results screen includes the message "Grading has been reversed".

For example, you might have a critical server used by an accounting department. This server must be accessible by the accounting VLAN but not by any other networks. To verify the configuration, you could set up a reverse-graded Ping test, and then run a Wi-Fi AutoTest profile to the server's guest SSID. The test reports a ping failure, which is the desired outcome.

Ping Test Results

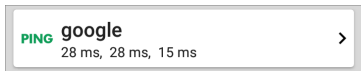

The Ping card shows the Ping test name entered in the Ping test settings and the three Ping response times from the target.

Tap the card to open the Ping results screen.

AutoTest Ping Results Screen

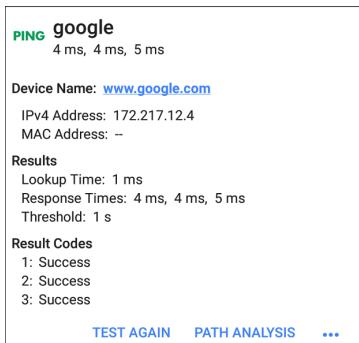

PING google
4 ms, 4 ms, 5 ms

Device Name: www.google.com

IPv4 Address: 172.217.12.4
MAC Address: --

Results
Lookup Time: 1 ms
Response Times: 4 ms, 4 ms, 5 ms
Threshold: 1 s

Result Codes
1: Success
2: Success
3: Success

[TEST AGAIN](#) [PATH ANALYSIS](#) ...

Device Name: Hostname or address of the target device.

- **IPv4 or IPv6 Address:** IP address of the target device.

- **MAC Address:** Target device's MAC address. The two dashes -- indicate that no MAC address was provided from the server.

Results

- **Lookup Time:** How long it took to resolve the URL into an IP address.
- **Response Times:** How long it took for the EtherScope to receive a response from the target after sending each of the three connections.
- **Threshold:** The Timeout Threshold indicated in the test's settings.

Results Codes: Final status of the test (Success or Failure) for each of the three connections.

Other Actions

Use the **blue links** or the blue action overflow icon **...** button at the bottom of the test results screens to perform other actions.

- Tap **TEST AGAIN** to run the Ping test again.
- Tap **PATH ANALYSIS** to open the Path Analysis app with the Ping test's information.

- Tap the blue action overflow icon **...** to open another testing app (Ping, TCP Connect, or Capture), to **Browse** to the Ping target address in your web browser, or to start a **Telnet or SSH** session.

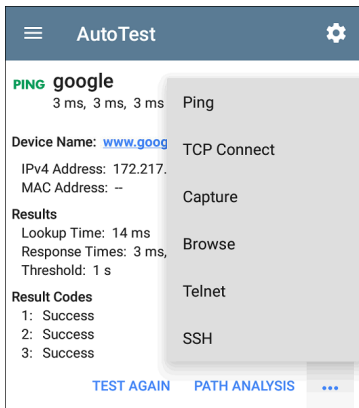

AutoTest TCP Connect Test

A TCP Connect test opens a TCP connection with the selected target to test for port availability using a 3-way handshake (SYN, SYN/ACK, ACK). The AutoTest Target TCP Connect test runs three connection tests and reports the response times.

TCP Connect Test Settings

TCP Connect Test	
Name	google
Device Name	www.google.com
IP Protocol Version	IPv4
Port	80 (www-http)
Timeout Threshold	1 s
Reverse Grading	<input type="checkbox"/> Disabled

Name

This field allows you to assign a custom name to the test. The name appears on the target test card in the profile.

Device Name

Enter the IP address or URL of the server you want to ping. If you enter an IP address, the DNS lookup portion of the test is skipped.

IP Protocol Version

IPv4 is used by default. Tap the field to switch between IPv4 and IPv6.

Port

Specify the TCP port number for the EtherScope to use to connect to the target.

Timeout Threshold

This threshold controls how long the EtherScope waits for a response from the target before failing the test.

Reverse Grading

When Reverse Grading is enabled, a test is considered successful if it fails and a failure if it succeeds. The Results Codes section of the results screen includes the message "Grading has been reversed".

TCP Connect Test Results

TCP **NetAlly** >
 80 ms, 76 ms, 82 ms

The TCP card shows the test name entered in the settings and the three response times from the target.

Tap the card to open the TCP results screen.

AutoTest TCP Results Screen

☰
AutoTest
⚙️

TCP **NetAlly**
 50 ms, 44 ms, 42 ms

Device Name: ip-184-168-221-49.ip.secureserver.net
 IPv4 Address: 184.168.221.49
 MAC Address: –
 Port: 80 (www-http)

Results
 Lookup Time: 21 ms
 Response Times: 50 ms, 44 ms, 42 ms
 Threshold: 250 ms

Result Codes
 1: Success
 2: Success
 3: Success

TEST AGAIN
 PATH ANALYSIS
 ⋮

Device Name: DNS name of the device tested

IPv4 or IPv6 Address: IP address of the target device

MAC Address: Device's MAC address. Two dashes -- indicate that no MAC address was provided.

Port: Port number tested

Results

Lookup Time: How long it took to resolve the URL into an IP address

Response Times: How long it took for the EtherScope to receive a response from the server for each of the three connect tests

Threshold: The Timeout Threshold indicated in the test's settings

Results Codes: Final status of the test (Success or Failure) for each of the three Pings

Other Actions

Use the **blue links** or the blue action overflow icon **...** button at the bottom of the test results screens to perform other actions.

- Tap **TEST AGAIN** to run the Ping test again.
- Tap **PATH ANALYSIS** to open the Path Analysis app with the TCP test's information.
- Tap the blue action overflow icon **...** to open another testing app (Ping, TCP Connect, or Capture), to **Browse** to the target address in your web browser, or to start a **Telnet or SSH** session.

HTTP Test

The HTTP test performs a comprehensive end user response time (EURT) measurement when downloading the specified web page. The target can be an IPv4 address, IPv6 address, or URL.

HTTP Test Settings

HTTP settings allow test grading based on responses, return codes, and time threshold.

HTTP Test	
Name	github
URL	https://www.github.com
IP Protocol Version	IPv4
Allow Redirects	<input checked="" type="checkbox"/> Enabled
Response Time Threshold	10 s
Web Page Transfer Size	ALL
Response Must Contain	

Name

Tap this field to assign a custom name to the test. The name appears on the target test card in the profile.

URL

Enter a target address. To reach web servers that operate on a non-default port, enter a colon (:), and specify the port number after the URL.

IP Protocol Version

IPv4 is used by default. Tap the field to switch between IPv4 and IPv6.

Allow Redirects

Tap the toggle button to permit web redirects when trying to connect to the target.

Response Time Threshold

This threshold controls how long the EtherScope waits for a response from the URL before failing the test. Tap the field to change the value.

Web Page Transfer Size

This setting allows you to limit the amount of data downloaded, ranging from the HTML **Header Only** to the entire page (**ALL**). Tap the field to select a different transfer size.

Response Must Contain	
Response Must Not Contain	
Return Code 200 - OK	
Reverse Grading Disabled	<input type="checkbox"/>
HTTP Proxy Disabled	<input type="checkbox"/>

Response Must Contain

Text entered here functions as **pass/fail** test criteria based on the presence of the text string on a specified server or URL. To construct a text string, enter a word or several words with exact spacing. When specifying several words, they must appear consecutively at the source. The test passes if the text string is found. If the string is not found, the test fails with the Return Code: "Response does not contain required text."

Response Must Not Contain

Like the setting above, except text entered here functions as **pass/fail** test criteria based on the *absence* of the text string on a specified server or URL. The test passes if the text string is not found. If the string is found, the test fails with the return code: "Response contains excluded text."

Return Code

The Return Code set here functions as **pass/fail** test criteria. The default is "OK (HTTP 200)." Tap the field to select a different Return Code from the list. If your selected Return Code value matches the actual return code value, the test passes, and if EtherScope receives a different return code, the test fails.

Reverse Grading

When Reverse Grading is enabled, a test is considered successful if it fails and a failure if it succeeds. The Results Codes section of the results screen includes the message "Grading has been reversed".

HTTP Proxy

The Proxy control in target test settings uses the server address and port specified in the main profile settings. Tap the toggle to use those Proxy settings. See [Wired Profile Settings](#) or [Wi-Fi Profile Settings](#).

HTTP Test Results



The HTTP card shows the test name entered in the test settings and response time from the target.

HTTP Test Results Screen

HTTP **github**
3.671 s





Device Name: ib-192-30-253-113-iad.github.com

IPv4 Address: 192.30.253.113

MAC Address: --

URL: <https://www.github.com>

Results

Metric	Result
Ping	54 ms
 DNS Lookup	59 ms
 TCP Connect	165 ms
 Data Start	1.288 s
 Data Transfer	2.157 s
Total Time	3.671 s
Threshold	10 s
Data Bytes	90.9 K
Rate (bps)	206.2 K

End User Response Time

Device Name: DNS name of the server tested

IPv4 or IPv6 Address: IP address of the server

MAC Address: Server's MAC address. The two dashes -- indicate that no MAC address was provided from the server.

URL: The target URL

Results

Ping: A ping test runs simultaneously with the HTTP test, and this result field displays the Ping response time. If the HTTP test finishes before the ICMP echo reply packet arrives, dashes -- are displayed for the ping test results. Ping results do not affect the Pass/Fail status of the test.

DNS Lookup: Amount of time it took to resolve the URL to an IP address. If you enter an IP address, DNS lookup is not required, so dashes are displayed to indicate that this part of the test was not executed.

TCP Connect: Amount of time it took to open the port on the server

Data Start: Time to receive the first frame of HTML from the web server

Data Transfer: Time to receive the data from the target server

Total Time: The end user response time (EURT), which is the total time it took to download the web page. It is the sum of DNS lookup, TCP connect, data start, and data transfer time. If the Total Time exceeds the Response Time Threshold in the settings, the test fails.

If the Response Time Threshold is exceeded during a step in the test, the current phase of the test (DNS Lookup, TCP Connect, Data Start, or Data Transfer) is denoted with a red dot, and the rest of the test is aborted.

Threshold: The Response Time Threshold from the test settings

Data Bytes: Total number of data bytes transferred. This does not include header bytes

Rate (bps): The measured data transfer rate

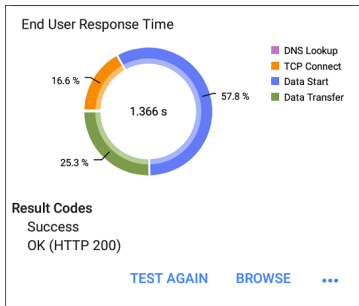

End User Response Time : Pie chart of the times for each phase of the test (DNS Lookup, TCP Connect, Data Start, and Data Transfer)

Results Codes: Final status of the test (Success or Failure)

The HTTP test also shows the **Return Code** from the website server.

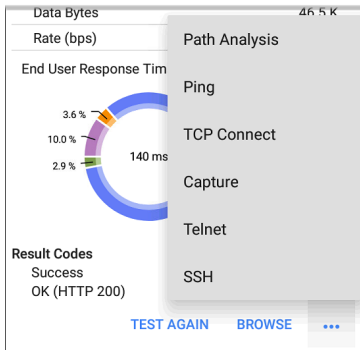

Tap [blue links](#) or the blue action overflow icon **...** at the bottom of the test results screens to run the HTTP **TEST AGAIN**, open another testing app, or **Browse** to the target address in your web browser.

Captive Portal Connections

The HTTP test supports connections through a network with a captive portal requirement.

When running a Profile that connects to a network with a [Captive Portal](#), a system

notification  appears to prompt you to enter the captive portal credentials.

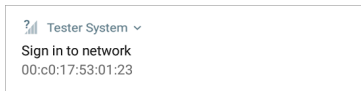

For the HTTP test to pass, you must select the notification and enter the required credentials on the portal website. Otherwise, the HTTP test fails, with a Result Code of "Captive portal detected (25)."

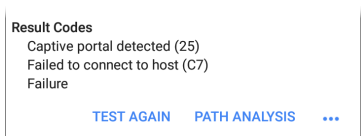

See [Captive Portals](#) for more instructions.

When finished in the captive portal browser window, hit the back button  to return to the HTTP test, and tap **TEST AGAIN** to receive valid results.

FTP Test

The FTP test performs a file upload to or download from an FTP server, allowing verification of server and network performance. The target can be an IPv4 address, IPv6 address, or URL. The results provide a complete breakdown of the overall file transfer time into its component parts.

FTP Test Settings

FTP settings allow you to specify a **Get** or **Put** test and the file path and name.

FTP Test	
Name	Asset Server
FTP Server	10.250.2.218
IP Protocol Version	IPv4
File	internal/iperf3
File Transfer Size	ALL
Direction	Get <input checked="" type="checkbox"/>
Response Time Threshold	10 s

Name

This field allows you to assign a custom name to the test. The name appears on the target test card in the profile.

FTP Server

Enter the IPv4 address or URL of the FTP server you want to test. If you enter an IP address, the DNS Lookup portion of the test is skipped.

IP Protocol Version

IPv4 is used by default. Tap the field to switch between IPv4 and IPv6.

File

This setting specifies the path and name of the file that is downloaded from (**Get**) or uploaded to (**Put**) the server, based on the **Direction** setting below. Tap the field to enter the file path and name.

File Transfer Size

This setting lets you limit the amount of data to be downloaded or uploaded. The default transfer size is **ALL**.

- When the **Direction** setting is **Get**, a transfer size of **ALL** causes the download to continue until the entire file is downloaded or the Response Time Threshold is exceeded.

Specifying a transfer size that is greater than file being retrieved does not cause the test to fail. The test stops when the file has finished downloading.

- When the **Direction** setting is **Put**, the default transfer size of ALL causes the EtherScope to create and upload a file that is 10 MB.

Direction

Tap the toggle button to switch between a **Get** (download the **File** from the server) or **Put** (upload the **File** to the server) test.

- If Direction is set to Get, the file is retrieved, and the size and data rate are calculated. This data is discarded as soon as it is downloaded and is not retained on the EtherScope.
- If Direction is set to Put, the File named above is created on the FTP server. The size of this file is determined by the **File Transfer Size** setting. The file contains a text string indicating that it was sent from the EtherScope, and the test string is repeated to produce the set file size.

Response Time Threshold

This threshold controls how long the EtherScope waits for a response from the FTP server before failing the test. Tap the field to change the value.

Username	
Password	
Reverse Grading Disabled	<input type="checkbox"/>
HTTP Proxy Disabled	<input type="checkbox"/>

Username and Password

Enter these credentials to access the target server you specified. Enter "anonymous" as the username to establish an anonymous connection. The test fails if the configured username or password are not valid on the target FTP server.

Reverse Grading

When Reverse Grading is enabled, a test is considered successful if it fails and a failure if it succeeds. The Results Codes section of the results screen includes the message "Grading has been reversed".

HTTP Proxy

The Proxy control in target test settings uses the server address and port specified in the main profile settings. See [Wired Profile Settings](#) or [Wi-Fi Profile Settings](#).

FTP Test Results



The FTP card shows the test name entered in the test settings and response time from the target.

FTP Test Results Screen

Metric	Result
FTP Asset Server	
171 ms	
Device Name: 10.250.2.218	
IPv4 Address: 10.250.2.218	
MAC Address: --	
Get File: /internal/iperf3	
Results	
Ping	50 ms
DNS Lookup	--
TCP Connect	44 ms
Data Start	116 ms
Data Transfer	10 ms
Total Time	171 ms
Threshold	60 s
Data Bytes	24 K
Rate (bps)	1.2 M

Device Name: Hostname of the server tested

IPv4 or IPv6 Address: IP address of the server

MAC Address: Server's MAC address. The two dashes -- indicate that no MAC address was provided from the server.

Get File: File path and name entered in the settings that was transferred to or from the FTP server.

Results

Ping: A ping test runs simultaneously with the FTP test, and this result field displays the Ping response time. If the FTP test finishes before the ICMP echo reply packet arrives, dashes -- are displayed for the ping test results. Ping results do not affect the Pass/Fail status of the test.

DNS Lookup: Amount of time it took to resolve the URL to an IP address. If you enter an IP address, DNS lookup is not required, so dashes are displayed to indicate that this part of the test was not executed.

TCP Connect: Amount of time it took to open the port on the server.

Data Start: Time to receive the first frame from the FTP server.

Data Transfer: Time to receive the file from the target server.

Total Time: The end user response time (EURT), which is the total time it took to download the web page. It is the sum of DNS lookup, TCP connect, data start, and data transfer time. If the Total Time exceeds the Response Time Threshold in the settings, the test fails.

If the Response Time Threshold is exceeded during a step in the test, the current phase of the test (DNS Lookup, TCP Connect, Data Start, or Data Transfer) is denoted with a red dot, and the rest of the test is aborted.

Threshold: The Response Time Threshold from the test settings.

Data Bytes: Total number of data bytes transferred. This does not include header bytes.

Rate (bps): The measured data transfer rate.

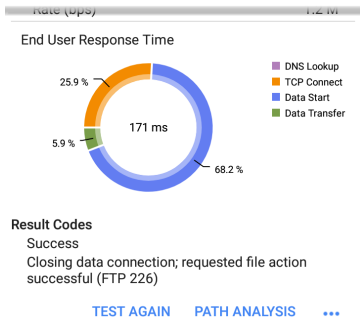

End User Response Time: Pie chart of the times for each phase of the test (DNS Lookup, TCP Connect, Data Start, and Data Transfer).

Results Codes: Final status of the test (Success or Failure).

The FTP test also shows the **Return Code** from the server.

Tap [blue links](#) or the blue action overflow icon **...** at the bottom of the test results screens to run the **FTP Test Again**, open another testing app, or **Browse** to the FTP server in your web browser.

Air Quality AutoTest Profiles

Air Quality Profiles perform a scan of the channels in your wireless network to measure channel utilization and interference.

Each table on the Air Quality results screen shows the top four channels in each band with the highest utilization, co-channel interference or adjacent channel interference, along with the number of APs operating on the channel.

Air Quality Profile results are described next. Tap here to skip to [Air Quality Settings](#).



Air Quality Profile

Top 2.4 GHz Channels By Utilization

Channel	APs	802.11 (%)
11	2	7
1	2	6
12	0	6
10	0	4

Channel	APs	Non-802.11 (%)
4	0	11
10	0	7
7	0	7
2	0	4

Top 2.4 GHz Channels By Co-Channel Interference

Channel	APs
11	2
1	2
5	1
9	1



The EtherScope scans the 2.4-GHz band first and displays results and then does the same for the 5-GHz band and then the 6GHz band if applicable.

Channel usage depends on the number of clients connected to the network and the amount of interference from devices like microwaves or smartphones using Bluetooth. Very high utilization or interference can affect network performance.

Air Quality Profile Results

The image below shows a completed Air Quality Profile test with two **Warnings** and two **Failures** indicated by the yellow and red dots next to the corresponding measurements.



Air Quality Profile

Top 2.4 GHz Channels By Utilization

Channel	APs	802.11 (%)
1	10	10
11	5	10
6	5	8
12	0	8



Channel	APs	Non-802.11 (%)
12	0	22
10	0	20
3	0	17
13	0	17

Top 2.4 GHz Channels By Co-Channel Interference

Channel	APs	
1	10	
11	5	
6	5	
2	1	



Top 2.4 GHz Channels By Adjacent Channel Interference

Channel	APs	
2	15	
1	1	
6	1	
--	--	

Air Quality test gradings are based on the Thresholds configured in the Profile's settings. In the case shown here, the Warnings and Failures occurred because of high Utilization and Co-channel Interference caused by the number of APs active on the top three 2.4 GHz channels: 1, 6, and 11.

802.11 Utilization %: Percentage of the displayed channel's capacity used by all 802.11 WLAN devices

Non-802.11 Utilization %: Percentage of the displayed channel's capacity being used by non-802.11 interferers, which may be non-WLAN sources

(EXG-200 only) If the **Combine Utilization** setting is enabled in [General Settings](#), there is only a

single combined 802.11 and non-802.11 Utilization Threshold.



Top 5 GHz Channels By Utilization

Channel	APs	802.11 (%)
153	0	7
149	1	6
161	0	6
157	6	5

Channel	APs	Non-802.11 (%)
52	0	1
56	0	1
--	--	--
--	--	--

Top 5 GHz Channels By Co-Channel Interference

Channel	APs	
157	6	
36	2	
149	1	
--	--	

Top 5 GHz Channels By Adjacent Channel Interference

Channel	APs	
149	6	



Two dashes -- indicate that no Utilization was detected on the Channels shown.

Co-channel Interference: Interference caused by multiple APs operating on the same channel that exceed the minimum **Co-channel Interference AP Signal Level** threshold in the settings. This measurement accounts for 40-MHz and 80-MHz channels in the 5-GHz band by counting an AP on its primary and each secondary channel.

Adjacent Channel Interference: Interference caused by multiple APs operating on adjacent channels that exceed the minimum **Adjacent channel Interference AP Signal Level** threshold in the settings. This is most common in the 2.4 GHz band where channels are 5 MHz apart but span 20 MHz. There are only three channels that do not overlap in this band: 1, 6, 11. Larger channel widths (e.g., 40 MHz) also affects the adjacent channel interference counts.

Results Codes: Final status of the test (Success or Failure)

Viewing and Saving Results

Viewing Channel Utilization

Tap the blue **CHANNELS MAP** link at the bottom of the Air Quality Profile screen to open the

Channels Map display in the Wi-Fi app. This display gives you real-time visual results of the utilization on each channel.

Uploading Results to Link-Live

Tap the blue **UPLOAD GRAPHS TO LINK LIVE** to upload graphic results to Link-Live. This opens the Link-Live sharing screen.

1. Use the default file name (which has a <DATE-TIME> format) or tap the Graphs Image Name field to open a touch keyboard to type a custom name.
2. Tap **SAVE TO UPLOADED FILES** to upload to the Results page  on [Link-Live.com](https://www.link-live.com).

Air Quality Profile FAB

(Optional) On the AutoTest Air Quality Profile results screen, tap the floating action button (FAB) and follow the screen instructions to attach comments and images to the results on the [Link-Live](https://www.link-live.com) website.

- The **Add Comments** option opens a Link-Live sharing screen where you can enter text and job comments.

- The **Add Picture** function lets you open the Gallery or Camera app to select or take a photo that is then uploaded and attached to your test result.

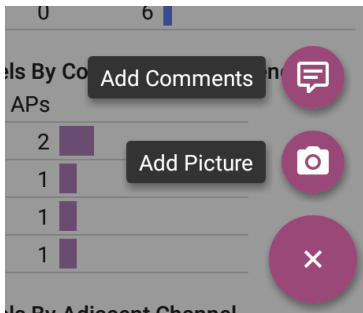

Air Quality Profile Settings

To configure the profile settings, tap the settings icon  on the Air Quality Profile screen, or add a new Air Quality Profile to AutoTest.

Air Quality Profile	
Name	Air Quality Profile
Channel Scan Cycles	3
AP Signal Level Threshold	-75 dBm
Grading	
Utilization	<input checked="" type="checkbox"/>
Enabled	
Warning	35 %
Failure	75 %

The settings for Air Quality are thresholds for grading the channel utilization and interference.

On the **Air Quality Profile** settings screen, tap each field described below as needed to

configure the profile. Changed settings are automatically applied.

When you finish configuring, tap the back button  to return to the profile.

Name

Tap the **Name** field to enter a custom name for the profile. This name appears on the main AutoTest screen profile card and the Air Quality profile screen header.

Channel Scan Cycles

This setting designates the number of times all of the channels should be scanned before reporting the results. Tap the field to enter a new value between 1 and 10.

AP Signal Level Threshold

This setting designates the minimum signal level at which an AP must be measured to be counted in Co-Channel and Adjacent Channel Interference measurements. Tap the field to select a new value or enter a custom one.

Grading

Use the grading threshold controls to adjust the values that determine **Warning/Fail** results for the corresponding utilization and co-channel interference and adjacent channel measurements. Tap each Warning or Failure field to select a new value or enter a custom one. Each threshold also has a toggle button that allows you to disable grading based on that measurement entirely.

Thresholds

Use the threshold controls to adjust the values that determine **Warning/Fail** results for the corresponding utilization and co-channel interference and adjacent channel measurements. Tap each Warning or Failure field to select a new value or enter a custom one. Each threshold also has a toggle button that allows you to disable grading based on that measurement entirely.

By default, you can set thresholds for both 802.11 and non-802.11 Utilization.

(EXG-200 only) If the **Combine Utilization** setting is enabled in [General Settings](#), there is only a

single combined 802.11 and non-802.11
Utilization Threshold.

Utilization measurements and thresholds are percentages of a channel's capacity. Co-channel interference measurements and thresholds are the number of APs operating on the same channel.

Adjacent Channel Interference measurements and thresholds are the number of APs operating on nearby channels that cause interference.

Co-Channel Interference

Enabled



Warning Threshold

4 APs

Failure Threshold

8 APs

Adjacent Channel Interference

Enabled



Warning Threshold

4 APs

Failure Threshold

8 APs



Ping/TCP Test App

The Ping/TCP test app runs a Ping or TCP Connect test to your chosen target, allowing you to monitor connectivity changes.

A Ping test sends an ICMP echo request to the selected target to determine whether the server or client can be reached and how long it takes to respond. A TCP Connect test opens a TCP connection with the selected target to test for port availability using a 3-way handshake (SYN, SYN/ACK, ACK).

You can open the TCP/Ping app from the Home screen, or you can select **Ping** or **TCP Connect** from another app, such as AutoTest or Discovery, while viewing a device's details.

Ping/TCP Settings

To configure a test, you can manually enter a hostname or IP address in the settings, or you can select Ping or TCP Connect from another testing app's device screen.

Populating Ping/TCP from Another App

When you open the Ping/TCP app from another app, the address is pre-populated as the Ping or TCP target device. For example, the floating action button (FAB) menu on the [Discovery](#) app screen shown below contains the option to open the Ping/TCP app.

The screenshot shows the Discovery app interface for a device named 'cos-lab-vm-cisco'. The device is identified as a Router with the name 'cos-lab-vm-cisco' and SNMP ID 'cos-lab-vm-cisco'. The IPv4 address '10.250.0.11' is highlighted with a green oval and labeled as '(Reachable)'. The MAC address is 'Cisco:40f4ec-f47681'. The device is a 'Statically Configured Router' discovered via SNMP. A 'Path Analysis' button is visible. Below this, the 'Addresses' section shows 'IPv4: 2' and 'MAC: 1', with a green arrow pointing to a 'Ping/TCP' button. The 'VLANs' section lists '1, 196, 500, 508, 526, 560' and has a 'Capture (Wired)' button. The 'Interfaces' section shows 'Up: 2' and 'Down: 41' with a 'Browse' button. A 'MIB' section is partially visible at the bottom. On the right side, there are several floating action buttons: a purple flag icon, a purple 'PING/TCP' button, a purple '0101' button with a network icon, a purple 'Browse' button with an upward arrow, and a purple 'X' button.

If you open the Ping/TCP app from this screen, the IPv4 address from the Discovery app is already configured as the Ping/TCP target.

The screenshot shows the Ping/TCP app interface. The top bar is dark blue with a hamburger menu icon, the text 'Ping', the text 'START', and a gear icon. Below the top bar, the text 'PING/TCP' is on the left, and the IPv4 address '10.250.0.11' is in the center, highlighted with a green oval.

Configuring Ping/TCP Settings Manually

To configure the target and settings manually, open the app's settings .

Ping/TCP Settings	
Device Name	www.google.com
IP Protocol Version	IPv4
Interface	Any Port
Number Of Tests	Continuous
Protocol	Ping
Frame Size (bytes)	64
Interval	1 s

Device Name: Enter the IP address or DNS name of the target.

IP Protocol Version: IPv4 is used by default. Tap the field to enable IPv6 instead.

Interface: This setting determines the EtherScope port from which the port scan runs. Tap the field to select the port. (See [Selecting Ports](#) for explanations of the different ports.)

Number of Tests: Tap to select the number of Ping or TCP connect tests you want to run. The default setting of **Continuous** keeps running tests until you tap the **STOP** button.

Protocol: Tap to select the **Ping** or **TCP Connect** protocol for the test.

Some of the following settings depend on the selected protocol.

Frame Size (bytes): (Appears only if the **Ping** Protocol is selected.) Specifies the total size of the payload and header the EtherScope sends. Tap a radio button to select a new size, or enter a Custom Value from 64 to 1518 bytes.

To test the Maximum Transmission Unit (MTU) along a route to a target, select the MTU frame

size you want to test, and set the **Do Not Fragment** setting (below) to **Enabled**.

Interval: (Appears only if the **Ping** Protocol is selected.) Controls how much time passes between each Ping sent from the EtherScope. By default, Pings are sent once every second (1 s). Tap a radio button to select a different interval, or enter a Custom Value between 100 and 10,000 milliseconds.

Port: (Appears only if the **TCP Connect** Protocol is selected.) Indicates the port number your EtherScope uses to connect to the target address for a TCP Port Open test. If needed, tap the **Port** field to open a pop-up number pad and enter a new port number. Tap **OK** to save it.

Timeout Threshold: This threshold controls how long the EtherScope waits for a response from the target before the test is failed.

Do Not Fragment: (Appears only if the **Ping** Protocol is selected.) Tap the toggle button to enable. See the Frame Size setting description above.

Running Ping/TCP Tests

Your unit must be connected to an active network ([Test or Management Port](#)) to run Ping and TCP Connect tests. Icons in the top Status Bar indicate whether and how your EtherScope is connected. See [Connection Notifications](#) for descriptions of the connection status icons, and select the appropriate **Interface** (or Any Port) from the [Ping/TCP settings](#).

The default target is google.com. Open the app settings  to enter a new target.

To begin the test, tap **START**.

If the Number of Tests setting is set to **Continuous**, the Ping/TCP app runs tests to your selected target until you tap **STOP**.

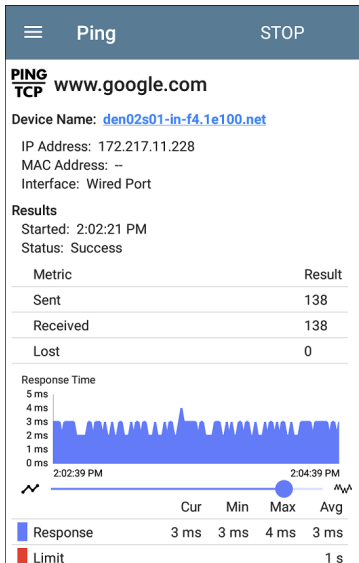

Device Name: Hostname or address of the target device

IPv4 or IPv6 Address: IP address of the target device

MAC Address: Target device's MAC address. The two dashes -- indicate that no MAC address was provided from the device.

Port: The port number used for the TCP Connect test. This field does not appear in Ping test results.

Interface: The EtherScope Test or Management Port from which the test is running

Results

- **Started:** Time the test started
- **Status:** Most recent test status
- **Sent:** Number of Pings or TCP SYN packets sent to the target
- **Received:** Number of Ping or TCP SYN/ACK packets returned from the target
- **Lost:** Number of Pings or TCP packets that were not returned from the target

Response Time graph: Plots the target device's response times in milliseconds. The graph saves and displays data for up to 24 hours in the past if the unit stays linked.

To pan and zoom on the graph, you can swipe, double tap, and move the slider. See the [Trending Graphs](#) topic for an overview of the graph controls.

Response: Table display of the Current, Minimum, Maximum, and Average response time measurements

Limit: The **Timeout Threshold** from the Ping/TCP app's settings



Capture App

Packet capture is the process of recording network traffic in the form of packets as data streams back and forth over the Wi-Fi or wired connections. Packet captures can help you analyze network problems, debug client/server communications, track applications and content, ensure that users are adhering to administration policies, and verify network security.

The capture process uses the [Wired or Wi-Fi Test port](#).

You can open the Capture app from the Home screen or using a link from another app, such as AutoTest, Discovery, or Wi-Fi.

Capture Settings

The Capture app settings allow you to switch between Wired and Wi-Fi, designate file and slice sizes, and apply filters to capture and analyze only certain packet types. For example, you can set a wired filter to capture only packets related to a specific application (based on IP address and port number), or create a Wi-Fi filter to capture only packets to and from a particular AP or client.

When you open Capture from Home and do not configure any filters, all packets from the switch or channel are captured. The default Wired capture saves all the packets sent from the local switch to the EtherScope. The default Wi-Fi capture saves the packets seen on channel 1.

If you open the Capture app from another NetAlly test app, Capture filters are automatically applied. Filters that can be applied from other apps include Wired IP and MAC or Wi-Fi Channel, Channel Width, and BSSID.

For example, the [floating action menu](#) on the Wi-Fi app's [BSSID Details screen](#) below contains the

option to start a Wi-Fi Capture.

The screenshot shows the 'Wi-Fi - BSSID' screen in the Capture App. At the top, there is a blue header with a hamburger menu icon and the text 'Wi-Fi - BSSID'. Below this, a Wi-Fi signal icon is followed by the BSSID 'Lnksys:c0c1c0-d7b562'. Underneath, the text 'BSSID' is displayed. The SSID is 'CiscoE4200-2G'. The AP is 'Lnksys:c0c1c0-d7b562'. The BSSID 'c0c1c0-d7b562' is highlighted with a yellow oval. Below that, the text '802.11' is shown, and the Channel '6' is also highlighted with a yellow oval. Further down, the following details are listed: 'Types: n, g, b', 'Signal: -39 dBm', 'SNR: 53 dB', and 'Security Type: WPA2-E'. The 'Last Seen' time is '3:39:58 PM'. To the right of these details are two buttons: 'Locate' and 'Connect', each with a corresponding icon. Below the details, there are three main sections: 'Rates and Capabilities' with a 'Capture (Wi-Fi)' button and a Wi-Fi icon; 'Clients' with a 'Name and Authorization' button and a shield icon; and 'RF and Traffic Statistics' with a close button (X) and a line graph icon. A yellow arrow points from the 'Capture (Wi-Fi)' button in the 'Rates and Capabilities' section to the right.

When the Capture app opens, filters are already set with the BSSID, Channel, and Channel Width from the Wi-Fi app.

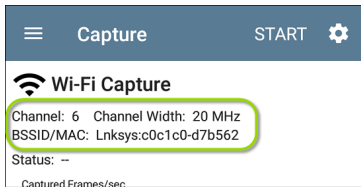

The Capture settings are saved until you clear the filters or open the app with new filters applied.

Tap the settings icon  in the Capture screen to configure capture settings.

Capture Settings	
File Size Limit	1 MB
Slice Size	Full Packet
Capture Port	Wi-Fi
Channel	34
Channel Width	20 MHz
Wi-Fi Filters	
BSSID/MAC	18b169-c83fc5

File Size Limit: Tap this field to specify a size for the capture file. The default size is 1 MB, and largest size allowed is 1000 MB. The capture stops when the captured file reaches this size.

When capture is running, the capture screen displays the current file size as data is captured.

Slice Size: Tap this field to select a specific frame slice size or enter a custom value. The Slice Size setting limits how much of each packet is captured. A smaller slice size is useful when you are interested in the packet's header but do not need to see all the payload data. The default is Full Packet.

Capture Port: Tap to select either the **Wired** or **Wi-Fi** test port.

Wired Filters

All filters are disabled by default unless you open Capture from another app. Tap the fields below to enable the filter and enter filter values.

MAC: Enter the MAC address of a host to capture only packets that contain the host's MAC address as the source or destination.

IP: Enter the IPv4 or IPv6 address of a host to capture only traffic to and from the host.

VLAN: Enter a VLAN number to capture only traffic tagged for that VLAN.

Port: Specify a port number to capture only traffic from that UDP or TCP port. For example, select port 80 to capture HTTP traffic only.

NOT: Sets up a logical NOT to use with capture values you have set up with other filters. For example, if you set up a filter to capture traffic to and from IP 10.250.0.70 on Port 80, and then you enable NOT, the EtherScope nXG captures all traffic *except* traffic to and from 10.250.0.70 on port 80.

Wi-Fi Filters

Channel: Tap the channel button to set the channel on which packets are captured.

Channel Width: (Appears only if you select a Channel number in the 5-GHz or 6-GHz band, above channel 14). Tap to select a width of 20, 40, 80, or (for 6-GHz band only) 160 MHz.

BSSID/MAC: Enter a BSSID to capture only packets going to or from the target device.

Control, Data, and Management Frames and Beacons: All frame types are captured by

default. Tap the toggle button for each frame type to disable its capture.

Running and Viewing Captures

To start Capturing, tap **START** at the top of the app screen.

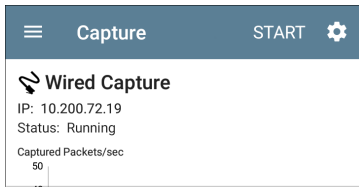

The current Status of the capture and any applied filters are shown under the capture type (Wired or Wi-Fi). The image above indicates that the app captures traffic for IP 10.200.72.19 only.

The Capture screen shows the real-time status of the capture as it runs.

The Wired graph plots the type and number of packets being captured while the capture is running and includes Unicast, Broadcast, and Multicast packet types.

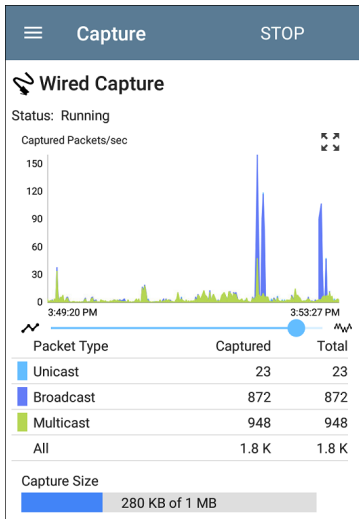

Wi-Fi captures graph the Management, Control, and Data Frame Types.

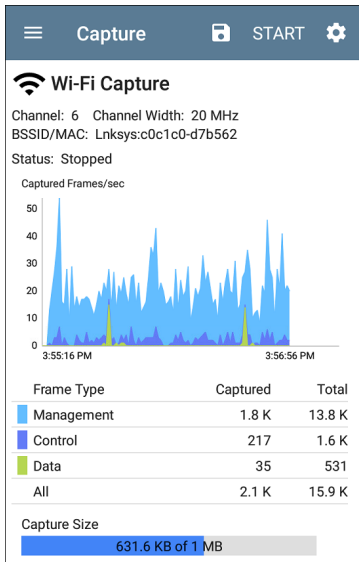

In the test shown above, the app has captured all three Wi-Fi Frame Types on channel 6 with the BSSID shown. The Total measurements in the table below the graph represent all frames

seen, while the Captured frames are those that fall within the filter parameters.

- If you navigate away from the Capture app, the capture process continues to run in the background until the File Size Limit (see [Capture Settings](#)) is reached.
- A capture also stops if you open the Wi-Fi app (which initiates scanning) or if you connect to a Wi-Fi network using AutoTest.
- To pan and zoom on the graphs, you can swipe, double tap, and move the slider. See the [Trending Graphs](#) topic for an overview of the graph controls.
- Tap **STOP** to stop the running capture before it reaches the File Size Limit.

Once a capture is completed, the **Save Capture** dialog appears automatically.

Tap the Save icon  to reopen this dialog.

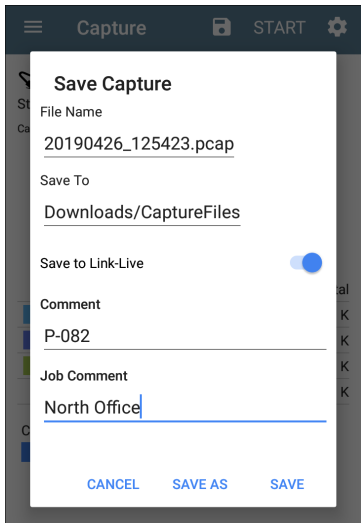

Save Capture

File Name
20190426_125423.pcap

Save To
Downloads/CaptureFiles

Save to Link-Live

Comment
P-082

Job Comment
North Office

CANCEL SAVE AS SAVE

Captures are saved as .pcap files. Tap any of the fields in the dialog to enter changes.

File Name: Capture files are automatically named using the date and time. Tap this field to enter a custom name.

Save to: By default, capture files are saved in the **Downloads** folder in the EtherScope file system. You can also save them to a Micro SD card or USB storage device or choose a different folder by tapping the **Save to** field. See also [Managing Files](#).

Save to Link-Live: You can also upload capture files to [Link-Live](#) and then download them for analysis on a PC. Capture (.pcap) files appear on the Uploaded Files  page in Link-Live.

Comment: This comment is attached to your capture file when it is uploaded to Link-Live.

Job Comment: This is the persistent [Job Comment](#) that uploads to Link-Live with all test results and files, until you change it. Changing the Job Comment here changes it throughout your unit.



Discovery App

The Discovery application creates an inventory of the devices on your networks along with their attributes: device types, names, addresses, interfaces, VLANs, resources, and other connected or associated devices. The app allows you to identify and analyze network devices and acts as a jumping-off point for further analysis using other apps, such as Wi-Fi, Path Analysis, and connection tests.

Devices are discovered in the local broadcast domains where the EtherScope is physically connected, as well as other configured subnets. By default, discovery processes run out of all available **test and management ports, wired and wireless**.

Discovery Chapter Contents

This chapter describes how the Discovery process and app screens work, shows examples of Discovery data, and details the Discovery settings.

[Introduction to Discovery](#)

[Main Discovery List Screen](#)

[Discovery Details Screens](#)

[Device Types](#)

[Device Names and Authorization](#)

[Discovery Settings](#)

[Problem Settings](#)

[TCP Port Scan Settings](#)

Introduction to Discovery

Discovery uses Ethernet, fiber, and Wi-Fi to find, classify, and display the details of network components. Information provided by Discovery can include the following:



- IP, BSSID, and MAC addresses
- Device Names
- Device Connectivity
- SNMP Data
- Network Problems
- Interface Details and Statistics

Devices are discovered via ARP and Ping sweeps; SNMP, DNS, mDNS, and netBIOS queries; and passive traffic monitoring. Discovery classifies each device as it is found. Up to 2,000 devices can be reported.

The Discovery app also detects **Problems** with discovered devices, including **Warning** and **Failure** conditions.

The EtherScope's discovery process begins when the unit is powered on. A channel **scanning**









notification  in the top Status Bar indicates that the EtherScope is scanning Wi-Fi channels to passively discover devices on the wireless network. Once a network connection ([wired or Wi-Fi, test or management](#)) is established, the active discovery process begins.

Discovery notification icons  indicate the progress of active discovery. This icon  indicates that no links are currently available for active discovery, either because none of the ports enabled for discovery are connected or because AutoTest is running.

The Discovery app consistently monitors network traffic, but the active discovery process reruns every 90 minutes by default. You can select a different Refresh Interval in the [Discovery Settings](#).

Main Discovery List Screen

The main Discovery screen lists all the devices the EtherScope has discovered.

Discovery (589)		🔍	⋮
🔍	📏	Name	▼
	AndroLinkSysWav	10.250.2.147	>
	AndroLinkSysWav	Belkin-454655	
	Andromeda Automati...	10.250.3.224	>
	Andromeda Automation Procurve	HP-235cc0	
	Angela's EtherScope ...	10.250.2.139	>
	Angela's EtherScope nXG - 530000	NetAlly-530000	
	Cetus	10.250.2.166	>
	Cetus	Dell-faa680	
	Cisco2500WLC	10.250.3.235	>
	Cisco2500WLC	Cisco-556c80	
	cos-lab-ad.netally.eng	--	>
	cos-lab-ad.netally.eng	VMware-678cc2	
	COS_DEV_SW4	10.250.0.4	>
	COS_DEV_SW4	Dell-b63fb6	
	cos_dev_sw27_huawei	10.250.0.12	>

Like in AutoTest and other EtherScope screens, the icons in Discovery change color to indicate a **Warning** or **Failure** condition. Discovery also displays device icons in **Blue** to indicate Problem-related information that does not constitute a warning or failure, and **Green** to indicate that a previous Problem has been resolved. (See the [Problem Settings](#) to adjust enabled Problems and thresholds.)

The Discovery screen, and other app screens with long lists, supports fast scrolling. Touch and drag the scrollbar handle to the right of the list to scroll quickly up and down.

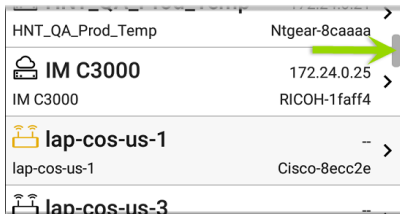

From the main Discovery screen, you can filter and sort the listed devices, open the left side

[navigation drawer](#) to configure settings, and tap a device's card to view its details.

Total number of discovered devices

Discovery (589)

Refresh Discovery

Discovery Settings

Filter

Sort

Touch a card to view device details.

Name	IP Address	MAC Address
AndroLinkSysWav AndroLinkSysWav	10.250.2.147	kin-454655
Andromeda Automati... Andromeda Automation Procurve	10.250.3.224	HP-235cc0
Angela's EtherScope ... Angela's EtherScope nXG - 530000	10.250.2.139	NetAlly-530000
Cetus Cetus	10.250.2.166	Dell-faa680
Cisco2500WLC Cisco2500WLC	10.250.3.235	Cisco-556c80
cos-lab-ad.netally.eng cos-lab-ad.netally.eng	-	VMware-678cc2
COS_DEV_SW4 COS_DEV_SW4	10.250.0.4	Dell-b63fb6
cos_dev_sw27_huawei	10.250.0.12	

Discovery List Cards

The information displayed on each device card varies depending on the selected Sort element and the data the EtherScope was able to discover.

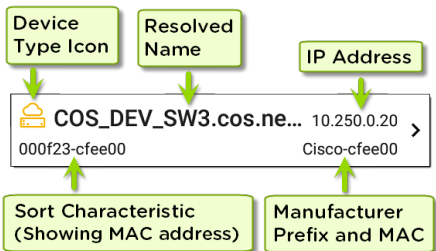

The lower left field displays the characteristic by which the Discovery list is currently sorted. In the image above, the list is sorted by MAC address. See [Discovery Sorts](#) in this topic for more about sorting.

Searching the Discovery List

The main Discovery screen offers a search feature. Tap the search icon  at the top of the

screen to search discovered devices.

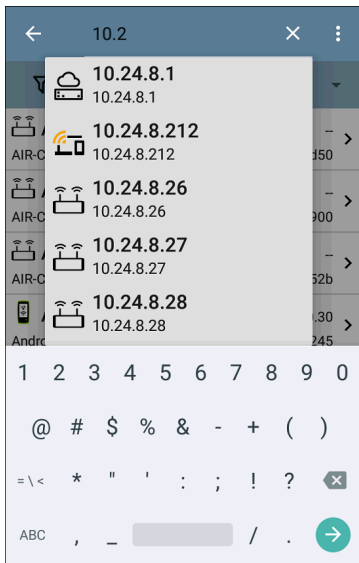



Filtering the Discovery List

Tap the filter button  near the top left of the main Discovery screen to set filters that control which devices are displayed in the list.

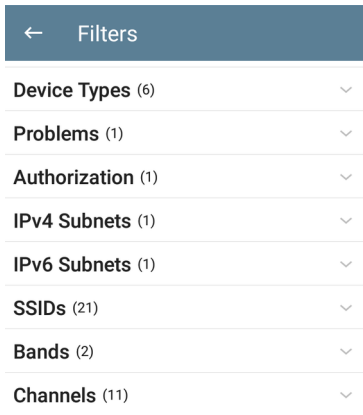

The Filters screen displays the number of devices or domains discovered for each category. Tap a category name to select filters by checking the boxes. The main Discovery

screen shows only those devices or IDs that fall under your chosen filter parameters.

When filters are selected, those active filters are displayed at the top of the Filters screen.

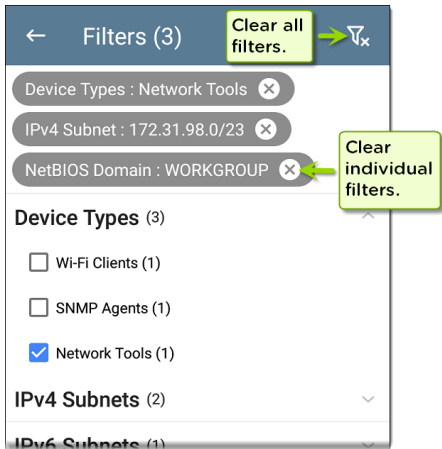

- Tap the **x** button to the right of each filter to clear it.

- Tap the clear filter icon at the top right to clear all filters.

After you select a filter, the Filters screen displays results filtered for that characteristic. For example, in the image above, the user has selected the **Network Tools** device type. As a result, only those subnets, addresses, Wi-Fi bands, etc., with a discovered Network Tool remain selectable in the filters list.

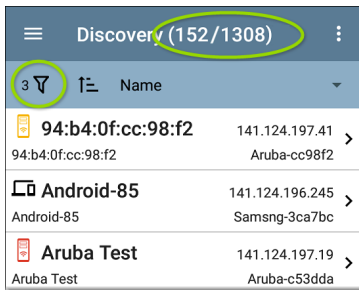

Back on the main Discovery screen, the screen title shows the number of filtered devices out of the total discovered devices (in the image above, 152 filtered devices out of 1308 total).

The number of active filters displays to the left of the filter icon (3 active filters in the image above).

Sorting the Discovery List

Tap the Sort bar or down arrow to open the Sort drop-down menu.



Select a Sort option to order the devices based on your selected characteristic.

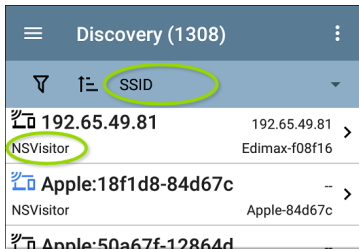

The selected Sort option displays in the Sort bar above the device list, and the sort characteristic for each device is shown under the device type icon. In the image above, all the devices associated with the "NSVisitor" SSID are sorted together. Individual devices on the same SSID are sorted numerically and alphabetically.

Tap the sort order icon  to switch the sort order between normal and reverse order.

Devices are sorted in groups. Those with resolved names appear at the top (in normal order), and then devices with only IPv4, IPv6, and MAC addresses appear below, respectively.

Reversing the normal sort order reverses the devices within the groups but does not change the order of the groups.

Security Auditing – Batch Authorization

Batch Authorization lets you extend filtering to organize devices into the following security categories:

- **Authorized:** For devices approved for use on your network
- **Neighbor:** For devices owned and controlled by neighboring organizations
- **Flagged:** To give visibility to a specific device
- **Unknown:** For devices that have not been identified or classified
- **Unauthorized:** For devices that should not be on the network and may present a security risk
- **Unspecified:** Default unassigned Authorization status

Once categorized, it is simple to immediately identify any new devices on the network by filtering according to Authorization type. New devices are identified as Unspecified.

To use the Batch Authorization feature, create a filter that identifies the devices you want to categorize. For example, you could filter on SSIDs used by other offices in your building. After you filter the list of discovered devices, select the overflow menu.

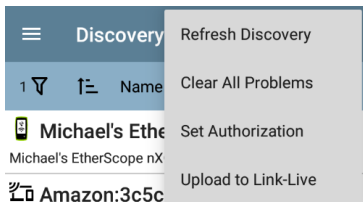

Select **Set Authorization** to see how these devices are currently categorized and the number of devices in each category. In the example below, 38 devices belong to other offices and have an Unspecified authorization.

Set Authorization

38 of 226 devices selected

- Authorized (0)
- Neighbor (0)
- Flagged (0)
- Unknown (0)
- Unauthorized (0)
- Unspecified (38)

CANCEL

OK

NOTE: The initial selection on this screen defaults to the category with the highest count. If other categories have non-zero counts, select **OK** to change the authorization settings for all devices to the selected category.

Select the appropriate security category. To continue the example above, you can select **Neighbor**, and then tap the **OK** button to identify the Unspecified devices from other offices as Neighbor.

Set Authorization

38 of 226 devices selected

Authorized (0)

Neighbor (38)

Flagged (0)

Unknown (0)







Unauthorized (0)

Unspecified (0)

CANCEL **OK**

You can [filter](#) the list by tapping the Filter icon , tapping **Authorization**, and then tapping

Neighbor to show only the Neighbor devices. You can also [sort](#) the list by Authorization to display the discovered devices with the Neighbor category clearly identified.

Discovery (79/276)		Search	More
1	Filter	Sort	Authorization
	AIR-CAP3702I-CO	-	>
Neighbor		Cisco-000d53	
	AirCheck_G3_5500c4	10.250.2.236	>
Neighbor		TRENDnet-eb8c72	
	BlackForestMist-Garage	-	>
Neighbor		Mist-dd6dd2	
	den-colspr-ap2	-	>
Neighbor		ExtremeN-01bae5	
	AmazonTe:dc91bf-938721	-	>
Neighbor		AmazonTe-938721	
	Apple:6c7e67-d13251	-	>
Neighbor		Apple-d13251	
	Apple:88665a-496103	-	>
Neighbor		Apple-496103	

See [Assigning a Name and Authorization to a Device](#) for more information on the Authorization feature.

NOTE: Batch Authorization operates on the default MAC address of a device. If a device has multiple MACs, authorization is set only on the default MAC address. Devices that do not have a discovered MAC address, such as unknown switches and off-net devices, cannot have an authorization setting.

Refreshing Discovery

Tap the action overflow icon  at the top right of the main Discovery screen, and select **Refresh Discovery** to refresh the active Discovery process.

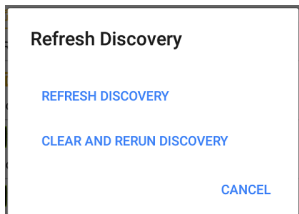

REFRESH DISCOVERY restarts the active discovery process without clearing the already discovered devices.

CLEAR AND RERUN DISCOVERY clears the accumulated results and restarts the discovery process.

Uploading Results to Link-Live

Tap the action overflow icon  at the top right of the main Discovery screen, and select **Upload to Link-Live** to send the current Discovery results to the Analysis page  on Link-Live.com.

NOTE: Wi-Fi app results automatically upload with the Discovery results.

**Link-Live**

by NetAlly



Discovery Snapshot Name

20190802_131842

Comment

1st Floor

Job Comment

Psych Building

SAVE TO ANALYSIS FILES

See the [Link-Live chapter](#) for more information.

Discovery Details Screens

Tap any of the device cards on the main Discovery list screen to view Device Details.

The example below calls out a Router card and its Details screen.

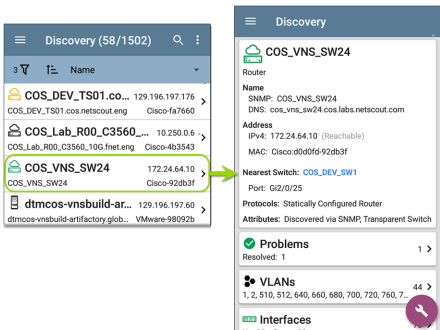



The available data and actions on the Details screens vary significantly depending on the device type, connections, and data the EtherScope was able to discover. In other words, only the discoverable information for each device is shown on the Details screen.

 **Discovery**

 **123.136.196.236**
Switch
Address
IPv4: 123.136.196.236 (Reachable)
IPv6: fe80::7ad2:94ff:fec0:e607
MAC: Ntgear:78d294-c0e607
Attributes: Discovered via SNMP, Transparent Switch

 **Addresses** 2 >
IPv4: 1 IPv6: 1 MAC: 1

 **VLANs** 3 >
1, 2, 3

 **Interfaces** 15 >
Up: 2 Down: 13

 **SNMP** >
Uptime: 11 weeks 1 day 5 hours 14 minutes



For the Switch screen shown above, Discovery was able to find an IP address but not a name for the switch.

Each Details screen shows additional information about the selected device, any Problems detected by the EtherScope, and counts for other connected or corresponding network elements.

Each Details screen also has a FAB button that lets you take additional actions or run other applications on the device. The available actions and applications depend on the device type and connection available. See [Discovery App Floating Action Menu](#) for more information.

See [Device Types](#) for specifics about the different devices the EtherScope can discover.

Top Details Card

The top card on the Details screen summarizes the discovered data for the selected device.



Aruba Test

Wi-Fi Controller

Name
SNMP: Aruba Test

Address
IPv4: 163.166.137.19 (Unassociated)
MAC: Aruba:186472-c53dda

Nearest Switch: [163.166.136.236](#)

Port: g1

Protocols: Statically Configured Router

Services: DHCP Server

The top of the card shows the device type(s) and icon (a Wi-Fi Controller with a **Failure or Error** status in the example image above).

The rest of the fields that appear on the top Details screen card depend on the device type and what the EtherScope can discover about the device.

On the Discovery Details screens, you can tap any **blue linked name or address** to open a Discovery or Wi-Fi Analysis screen for the linked device.

NOTE: Non-underlined links open in the same app (in this case Discovery), and [underlined links](#) open in a different app (in this case Wi-Fi) .



The screenshot shows the Discovery app interface. At the top, there is a blue header with a hamburger menu icon on the left and the word "Discovery" in white. Below the header, the main content area has a white background with a grey border. It starts with a yellow Wi-Fi router icon followed by the text "Cisco3702". Underneath, it says "Lightweight AP". The "Name" section lists "AP: Cisco3702" and "SNMP: Cisco3702". The "Address" section lists "IPv4: 10.250.3.69 (Reachable)", "IPv6: 2001:c001:c0de:500:ba38:61ff:fe6e:1ae0", and "MAC: [Cisco:b83861-6e1ae0](#)". The "802.11" section lists "Channels: 1, 64" and "Type: 802.11ac". The "Nearest Switch:" is listed as "~ Unknown Switch 3 ~". The "Wi-Fi Controller:" is listed as "[Cisco2500WLC](#)" followed by "10.250.3.235". At the bottom, it says "Last Seen: 5:23:20 PM".

The linked and underlined Cisco MAC address in the screen image above opens the Wi-Fi app's AP Details screen, where you can view the other

wireless attributes associated with the Lightweight AP. The Nearest Switch and Wi-Fi Controller links open a Discovery app Details screen for those devices.

Data Fields on the Top Details Card

These fields may appear on the top card of a Device Details screen, depending on the device type and the information EtherScope discovered:

Name: Discovered hostname(s) of the device. This section can display user-defined, DNS, mDNS, SNMP, NetBIOS, AP, and Virtual Machine names as discovered.

Address: Discovered IPv4, IPv6, BSSID, and/or MAC addresses of the device. This section displays the default (first discovered) addresses of each type. For more addresses, select the [Addresses](#) card when available.

Authorization: This field shows the user-assigned Authorization status of the device. See [Assigning a Name and Authorization to a Device](#).

802.11: Wireless data

Channels: Wi-Fi channels on which the device is operating

Type(s): 802.11 media type(s) supported by the device

Nearest Switch: Name or address of the switch identified as closest to the device

Port: Physical port where the device is connected

VLAN ID: ID of the VLAN the device is on

Protocols: Routing protocols, discovered via packet analysis, operating on the device or network

Services: Network services provided by this device, such as DHCP or DNS

Attributes: Other discovered attributes about the device

Wi-Fi Controller: Name and address of the Wi-Fi Controller for a Lightweight AP

AP: Access Point to which the device is connected

SSID: Name of the network on which the device is operating

Security: AP's security type

Hypervisor: Name of the hypervisor on which a virtual machine is operating

Virtual Machine: Name of the virtual machine

Guest OS: Operating system running on the virtual machine

Memory Reservation: Amount of memory reserved for the virtual machine

Last Seen: Time at which EtherScope most recently detected the device

Lower Cards in Device Details

Tap any of the lower cards on a Device Details screen to view more discovered characteristics and "drill down" to specific Problems, Addresses, Interfaces, etc. for the selected device.

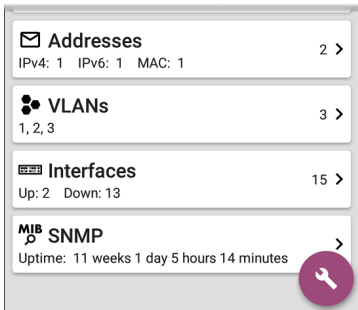

Screens with a list, such as Addresses shown below, also offer Sort options.

Addresses (3)		
↑	Address	▼
IPv4 10.250.0.1 10.250.0.120	BSSID	/22 549 >
IPv6 2001:c001:c0de 2001:c001:c0de	IP Address	... 549 >
IPv6 fe80::16 fe80::1618:77ff::	IPv6 Address	549 >
	Mfg-MAC Address	549 >
	MAC Address	

The rest of this topic provides examples of each type of Details screen and options for additional analysis.

Remember, you can tap any card with a right pointing arrow ➤ to open a new screen with more information about the device or characteristic.

Problems

The Problems card shows the icon color of the highest severity problem, and the number of detected **Warning**, **Failure or Error**, **Information**, and **Resolved** conditions for the device or network component.



Tap the Problems card to view the Problems list screen (unless only 1 Problem is detected, in which case, the detailed Problem description opens, skipping the list screen).

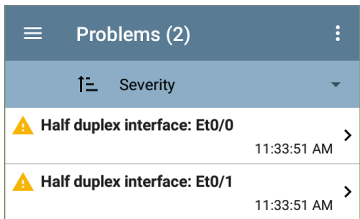

Tap the sort field to sort the list by **Severity** or by the time when the problem was **First Detected**.

On the Problems list screen, tap a Problem's row to read a detailed description.

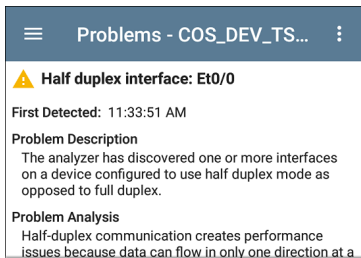

The screenshot shows a mobile application interface for 'Problems - COS_DEV_TS...'. At the top left is a hamburger menu icon, and at the top right is a vertical ellipsis (three dots) icon. Below the header, there is a yellow warning triangle icon followed by the text 'Half duplex interface: Et0/0'. Underneath this, it says 'First Detected: 11:33:51 AM'. The section is titled 'Problem Description' and contains the text: 'The analyzer has discovered one or more interfaces on a device configured to use half duplex mode as opposed to full duplex.' Below that is the 'Problem Analysis' section with the text: 'Half-duplex communication creates performance issues because data can flow in only one direction at a'.

To clear a problem, tap the action overflow button  at the top right of the Problem list or description screen, and then tap **Clear Problem**.

See [Problem Settings](#) to select which problems are detected and displayed by your unit.

Addresses

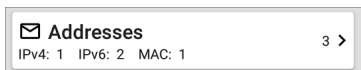

The screenshot shows a mobile application interface for 'Addresses'. At the top left is an envelope icon, followed by the text 'Addresses'. At the top right is the text '3 >'. Below this, it says 'IPv4: 1 IPv6: 2 MAC: 1'.

The Addresses card displays the number of each type of address discovered: IPv4, IPv6, MAC, and/or BSSID. Tap to view the addresses and related information.

Addresses (3)	
↑	Address
IPv4 10.250.0.120	10.250.0.0/22 >
10.250.0.120	Dell-3b5649
IPv6 2001:c001:c0de:500:1618:77f...	>
2001:c001:c0de:500:1618:77ff:fe3b:...	Dell-3b5649
IPv6 fe80::1618:77ff:fe3b:5649	>
fe80::1618:77ff:fe3b:5649	Dell-3b5649

From the Addresses list screen, you can sort the list order and tap any of the discovered addresses to investigate the address further.

TCP Port Scan

If you have run a TCP Port Scan (from the [Discovery FAB](#)) on a device or IP address, a TCP Port Scan card appears on the device's Details screen.

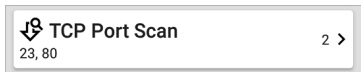

This card lists open port numbers and shows the total quantity of open ports. Tap the card to open the TCP Port Scan screen.

You can also open this screen from the [Discovery floating action menu](#).

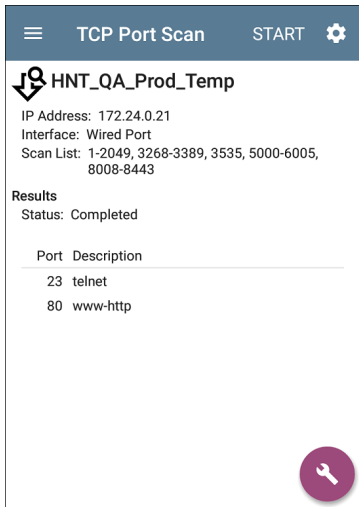

The screenshot shows the 'TCP Port Scan' results screen. At the top, there is a dark blue header with a hamburger menu icon on the left, the title 'TCP Port Scan' in the center, and the word 'START' and a gear icon on the right. Below the header, the device name 'HNT_QA_Prod_Temp' is displayed with a download icon to its left. The scan details are listed below: 'IP Address: 172.24.0.21', 'Interface: Wired Port', and 'Scan List: 1-2049, 3268-3389, 3535, 5000-6005, 8008-8443'. A 'Results' section follows, with 'Status: Completed'. Below this is a table with two columns: 'Port' and 'Description'. The table contains two rows: '23 telnet' and '80 www-http'. In the bottom right corner of the screen, there is a purple circular button with a white wrench icon.

☰ TCP Port Scan START ⚙️

📄 HNT_QA_Prod_Temp

IP Address: 172.24.0.21
Interface: Wired Port
Scan List: 1-2049, 3268-3389, 3535, 5000-6005, 8008-8443

Results
Status: Completed

Port	Description
23	telnet
80	www-http

🔧

The top of the TCP Port Scan results screen shows the name or IP address of the tested device and the following fields:

IP address: IP address of the device that was scanned

Interface: Test or management port from which the test ran, set in the [TCP Port Scan settings](#)

Scan List: List of port numbers tested

Results

Status: Current status of the port scan

Port/Description: List of all the detected open ports with their descriptions

See also [TCP Port Scan Settings](#).

VLANs

The VLANs card displays the VLAN IDs this device is using or for which it is configured.

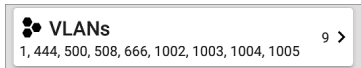

This card does not appear if no VLANs are detected or configured. Tap the card to open the VLANs screen.

COS_DEV_SW33	
 VLANs	
VLAN	Description
1	default
444	VLAN0444
500	VLAN0500
508	LabWiFi
666	VLAN0666
1002	fddi-default
1003	token-ring-default
1004	fddinet-default
1005	trnet-default

The VLANs Details screen also shows the description with each VLAN ID.

Interfaces

Interface are discovered using SNMP.

 Interfaces	171 >
Up: 20 Down: 151	

The Interfaces card shows the number of Up and Down interfaces and the total number of Interfaces to the right.

Tap the card to view the list of Interfaces.

Interfaces (171)		↻
⌵	Interface Status	▾
↑	VLAN-1002 Status: up	0 b VLAN: 1002 >
↑	VLAN-1003 Status: up	0 b VLAN: 1003 >
↑	VLAN-1005 Status: up	0 b VLAN: 1005 >
↓	Fa1 Status: down	100 Mb VLAN: -- >
↓	Gi1/3 Status: down	1 Gb FDx VLAN: 1 >

Like other Discovery list screens, the Interfaces list provides a number of Sort options, and the selected sort option affects the type of information displayed. The image above shows Interfaces sorted by Status (up or down). The image below shows Interfaces sorted by MAC Address, so each Interface's MAC address is displayed.

Interfaces (10)			
↑	MAC Address		
↑ Et0/0	0009b7-fa7660	10 Mb HDx	> VLAN: --
↑ Et0/1	0009b7-fa7661	10 Mb HDx	> VLAN: --
↑ Et0/1.500	0009b7-fa7661	10 Mb	> VLAN: --
↑ Et0/1.522		10 Mb	> VLAN: --

Tap an Interface row to open a new Discovery Details screen for that Interface.

The screenshot shows a mobile application interface with a dark blue header bar. On the left is a hamburger menu icon, and on the right is a refresh icon. The header text is 'COS_DEV_TS01.cos.net...'. Below the header is a white card with a yellow arrow icon and the text 'Et0/1'. Underneath, it says 'DOT1Q Trunk to CISCO_3750_PoE COS_DEV_SW2 f...'. The 'Status: up' is followed by 'Speed: 10 Mb', 'Duplex: HDx', and 'MTU: 1500'. The 'Connected Device: COS_DEV_SW1' is shown in blue text, with 'Port: Gi2/0/30' below it. The 'Address' section shows 'MAC: Cisco:0009b7-fa7661'. Below this card are two more cards: 'Devices' with a folder icon and '0 >' on the right, and 'Statistics' with a line graph icon and '>' on the right. The statistics row shows 'Util: 0.3 % Discards: 0.0 % Errors: 0.0 %'.

☰ COS_DEV_TS01.cos.net... ↻

↑ Et0/1

DOT1Q Trunk to CISCO_3750_PoE COS_DEV_SW2 f...

Status: up
Speed: 10 Mb
Duplex: HDx
MTU: 1500

Connected Device: COS_DEV_SW1
Port: Gi2/0/30

Address
MAC: Cisco:0009b7-fa7661

📁 Devices 0 >

📈 Statistics >

Util: 0.3 % Discards: 0.0 % Errors: 0.0 %

The Interface Details screen contains a description of the interface and information about its Status, Connected Device and Port, and Address.

MTU: Maximum Transmission Unit, the maximum packet frame size configured on the interface port

From this screen, you can tap the lower cards to review any discovery **VLANs** and **Devices** for the Interface as well as graphs of the Interface **Statistics**.

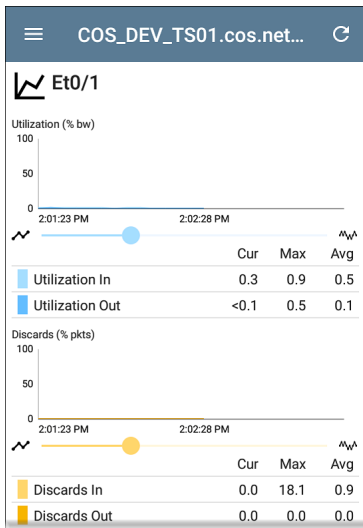

The Statistics screen displays real-time trending graphs of Utilization, Packet Discards, Packet Errors. See the [Trending Graphs](#) topic for an overview of the graphs' pan and zoom controls.

Below the trending graphs are pie charts of Packet transfers to and from the Interface.

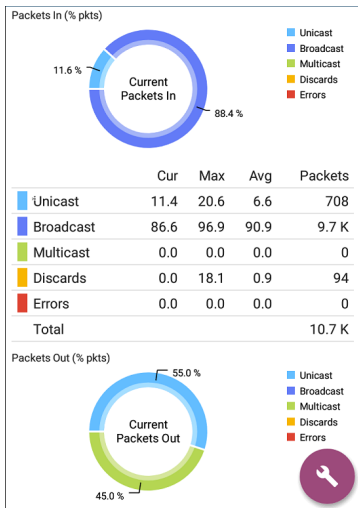

SNMP

 **MIB SNMP**

Uptime: 5 weeks 6 days 2 hours 57 minutes



This card shows SNMP Uptime. Tap the card for additional details.



COS_DEV_SW34

 **MIB SNMP**
SNMP System Group

Uptime: 5 weeks 6 days 2 hours 58 minutes

Manufacturer: Cisco

Model: cat4500e

Serial Number: FOX1407GRJA

HW Version: V02

SW Version: 15.2(2)E7

Description:

Cisco IOS Software, Catalyst 4500 L3 Switch Software (cat4500e-ENTSERVICES-M), Version 15.2(2)E7, RELEASE SOFTWARE (fc3)

Technical Support:

<http://www.cisco.com/techsupport>

Copyright (c) 1986-2017 by Cisco Systems, Inc.

Compiled Wed 12-Jul-17 14:36 by

SNMP

Type: SNMP v1/v2/v3

Engine ID: 80000009030068efbd6f4b80

Communication: SNMP v2

Using: Default Community String: public

SNMP System Group: These data fields are gathered from the system group and other key device version information.

SNMP: SNMP versions the device supports, Engine ID (for v3), and how the EtherScope is currently communicating with the device, along with credentials, including the Community String in use

Connected Devices



The Connected Devices card appears on the Details screen for [Unknown Switches](#). While the EtherScope may be unable to directly identify the connected switch, the devices connected to it provide clues about where the switch is operating.



 **Connected Devices**

8 >

The Connected Devices card shows the number of discovered devices that are connected to the Unknown Switch. Tapping the card opens a Discovery list screen with the connected devices.

Connected Devices (8)		
↑	IP Address	▼
	10.250.2.143	-- >
	10.250.2.143	NetAlly-02506e
	10.250.2.177	-- >
	10.250.2.177	TRENDn-af1e30
	10.250.3.32	-- >
	10.250.3.32	NetAlly-0210...

Resources

 **Resources** >

CPU: 28% Memory: 35%

The Resources card shows the percentages of CPU, memory, and storage usage on the device. This information is gathered via SNMP.

Tap the card to view current and maximum resource utilization measurements.

COS_DEV_SW34		
 Resources		
	Cur	Max
CPU %	12	12
Memory %	60	60
Last Update: 1:44:22 PM		

By default, EtherScope displays a **Warning** condition if CPU, Memory, or Storage utilization is above 90%. You can adjust problem detection and thresholds in the [Problem Settings](#) accessed from the Discovery [navigation drawer](#).

SSIDs

The SSIDs card appears in the Details for [Wi-Fi Controllers](#). This information is gathered via SNMP.



This card shows the number of SSIDs gathered from SNMP. Tap the card to view the list of SSIDs.

Cisco2500WLC		
SSIDs		
SSID	Security	VLAN
✓ CiscoQATest-maana	WPA2-P, WPA-P	--
✓ Cisco WEP64 OA	WEP	--
✓ aa-Cisco-Wep	WEP	--
✓ aonly	WPA2-P, WPA-P	--
✓ Cisco ISE	WPA2-E	--
✓ RF Chamber	WPA2-P, WPA-P	--
✓ Lobo	WPA2-P, WPA-P	--
✓ COS Cisco Captive Portal	Web	--
✗ Portal Test	Web	--
✓ [Cisco Hidden]	WPA2-P	--
✓ Cisco 2.4G	WPA2-P	--

On the SSIDs screen, each SSID is shown with its Security type(s) and any VLANs. SSIDs with a checkmark to the left are enabled, and those with an ✗ are disabled.



Discovery App Floating Action Menu

The floating action button (FAB) on Details screens offers additional actions depending on the device type and connection available.

Opening other NetAlly apps, such as [Path Analysis](#), [Ping/TCP](#), or [Capture](#)

from a Details screen auto-populates the new app with the device's name and/or address. In this way, both the Discovery and [Wi-Fi](#) apps provide a helpful shortcut that avoids making you retype the target addresses in other testing apps.

- Tap **TCP Port Scan** to open the [TCP Port Scan screen](#) in the Discovery app.
- Tap **Browse** to open the Chromium browser.

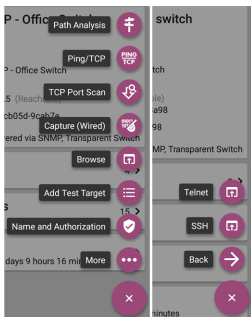



- Tap **Add Test Target** to create a new AutoTest target matching the currently selected device. A dialog first displays to select the test type, then the AutoTest app opens, displaying the newly added target's settings. You can then further customize the target.
- For devices with a MAC address or BSSID, tap **Name** and **Authorization** to open a dialog that lets you assign a custom user name and Authorization status. See [Assigning a Name and Authorization to a Device](#) in the Wi-Fi app chapter.
- Tap **More** to open a secondary list of floating action buttons:
 - Tap **Telnet** or **SSH** to open the JuiceSSH app.
 - Tap **Back** to return to the primary FAB list.

Auto-Populating Device Addresses

When another app is opened from the FAB, the default address and name shown on the [Top Details Card](#) are the targets populated.

For example, the Router shown in the Details screen below has multiple IPv4 and MAC addresses (which can be viewed by tapping the Addresses card).

 **Discovery**

 **Rack5SW1.fnet.eng**
Router

Name
SNMP: Rack5SW1.fnet.eng

Address
IPv4: 10.250.3.207 (Reachable)
MAC: Cisco:00141c-8945c1

Nearest Switch: [COS_DEV_SW1](#)
Port: Gi2/0/39

Protocols: Statically Configured Router

Attributes: Discovered via SNMP, Transparent Switch

 **Addresses** 6 >
IPv4: 6 MAC: 5

 **VLANs** 66 >
1, 2, 21, 42, 78, 85, 154, 202, 236, 378, 478, 5...

 **Interfaces** Up: 12 Down: 30



When you open the FAB and select a different app, such as Path Analysis, only the address and name listed at the top of the Details screen are populated in the Path Analysis app.



This screenshot shows the details for a device named Rack5SW1.fnet.eng. It includes a cloud icon with a router symbol, the device name, and the type 'Router'. Under the 'Name' section, the SNMP address is 'Rack5SW1.fnet.eng'. Under the 'Address' section, the IPv4 address is '10.250.3.207 (Reachable)' and the MAC address is 'Cisco:00141c-8945c1'. Two green arrows point to the SNMP and IPv4 address fields.

 **Rack5SW1.fnet.eng**
Router

Name
SNMP: Rack5SW1.fnet.eng

Address
IPv4: 10.250.3.207 (Reachable)
MAC: Cisco:00141c-8945c1

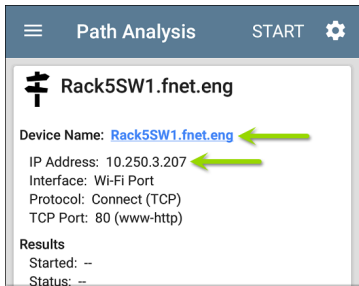

This screenshot shows the Path Analysis screen. The header includes a menu icon, the title 'Path Analysis', the word 'START', and a settings gear icon. The main content area shows the device name 'Rack5SW1.fnet.eng' with a flag icon. Below this, the 'Device Name' is listed as a blue link 'Rack5SW1.fnet.eng', followed by the 'IP Address: 10.250.3.207', 'Interface: Wi-Fi Port', 'Protocol: Connect (TCP)', and 'TCP Port: 80 (www-http)'. The 'Results' section shows 'Started: --' and 'Status: --'. Two green arrows point to the Device Name and IP Address fields.

☰ **Path Analysis** START ⚙️

 **Rack5SW1.fnet.eng**

Device Name: [Rack5SW1.fnet.eng](#)
IP Address: 10.250.3.207
Interface: Wi-Fi Port
Protocol: Connect (TCP)
TCP Port: 80 (www-http)

Results
Started: --
Status: --

To open another screen or app with a different address, open the Addresses card, and select another address to view its Details screen.

Device Types

The Discovery app lists and analyzes the types of devices explained in this section. Different data may be available to the EtherScope depending on the device type, how it was discovered, and your configured settings.

See [Discovery Settings](#) for [SNMP Configuration](#) and [Devices Discovered Through Other Devices](#) options.

For descriptions of the different Details cards and screens, see [Discovery Details](#).

The images in the rest of this section show examples of data that Discovery may display for each device type.

Routers

EtherScope discovers IP routers by monitoring traffic and querying hosts.

 **Discovery**

 **COS_DEV_SW34**
Router

Name
SNMP: COS_DEV_SW34

Address
IPv4: 10.250.0.34 (Reachable)
MAC: Cisco:68efbd-6f4bbf

Nearest Switch: [Rack5SW1.fnet.eng](#)
Port: Gi1/0/11
VLAN ID: 500

Protocols: Statically Configured Router

Attributes: Discovered via SNMP, Transparent Switch

 **VLANs** 17 >
1, 244, 500, 801, 803, 804, 805, 806, 825, 830...

 **Interfaces** 171 >
Up: 20 Down: 151

 **SNMP** >



Switches

Switches are also discovered by monitoring traffic and querying hosts.

 **Discovery**

 **cos-dev-sw18-poe**

Switch

Name
SNMP: cos-dev-sw18-poe



Address
IPv4: 10.250.3.216 (Reachable)
MAC: Cisco:503de5-220c43

Attributes: Discovered via SNMP, Transparent Switch

 **Addresses** 2 >
IPv4: 2 MAC: 2

 **VLANs** 37 >
1, 11, 196, 500, 502, 504, 508, 510, 511, 518, ...

 **Interfaces** 38 >
Up: 9 Down: 29

 **SNMP** 
Uptime: 27 weeks 2 days 7 hours 25 minutes

Unknown Switches

Unknown switches are detected indirectly by analyzing traffic going through surrounding switches. The EtherScope cannot identify the switch, but it can sense where a switch is active on the network via the device MAC addresses in that space.

The EtherScope numbers the switches as they are discovered. (These numbers may change each time the discovery process runs.)

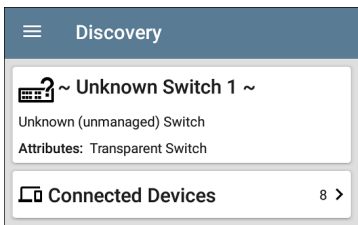

The Unknown Switches Details screen shows the number of devices connected to the switch. Tap the [Connected Devices](#) card to view the connected devices, which may provide clues about the location of the unknown switch.

Network Servers

Network servers include NetBIOS, DHCP, and DNS servers.

☰ Discovery

 **Compass.netally.eng**

Network Server

Name
Virtual Machine: [Compass.netally.eng](#)
DNS: [compass.fnet.eng](#)
NetBIOS: COMPASS

Address
IPv4: 10.250.3.221 (Reachable)
IPv6: 2001:c001:c0de:500:d1f5:d8e0:a81:3397
MAC: VMware:000c29-13235b

Nearest Switch: ~ [Unknown Switch 4](#) ~

Hypervisor: [COS-PNT-VM.fnet.eng](#)
10.250.3.251

Virtual Machine
Guest OS: Windows Server 2008 Standard Edition,
32-bit Service Pack 2 (Build 6003)
Memory Reservation: 2,048MB

Services: DNS, Virtual Machine





 **Addresses**

IP 1 1 IP 6 0 MAC 0

Hypervisors

VMware hypervisors are discovered via SNMP. The hypervisor's SNMP agent must be enabled for the EtherScope to discover it and classify it as a hypervisor.

 **Discovery**

 **COS-PNT-VM.fnet.eng**

Hypervisor

Name
SNMP: COS-PNT-VM.fnet.eng



Address
IPv4: 10.250.3.251 (Reachable)
IPv6: fe80::1618:77ff:fe34:db2a
MAC: Dell:141877-34db2a

Nearest Switch: ~ **Unknown Switch 4** ~

Hypervisor
Product Name: VMware ESXi
Product Version: 6.7.0
Product Build: 13644319
Memory: 98207MB
CPUs: 2
Virtual Machines: 16

Services: Hypervisor

Attributes: Port Aggregation

 **Addresses** 

IPv4: 1 IPv6: 1 MAC: 1

Virtual Machines

VMware virtual machines are discovered from VMware client table in SNMP-enabled VMware hypervisors. Devices are also classified as Virtual Machines if they have a VMware MAC.

☰ **Discovery**

 **Cisco ACS 5.8 Linux**

Virtual Machine

Name
Virtual Machine: Cisco ACS 5.8 Linux

Address
IPv4: 10.250.0.59 (Reachable)
IPv6: 2001:c001:c0de:500:20c:29ff:fe0b:e61c
MAC: VMware:000c29-0be61c

Nearest Switch: ~ Unknown Switch 4 ~

Hypervisor: COS-PNT-VM.fnet.eng
10.250.3.251

Virtual Machine
Guest OS: Linux 2.6.32-431.20.3.el6.x86_64 Red Hat Enterprise Linux Server release 6.4 (Santiago)
Memory Reservation: 4,096MB

Services: Virtual Machine

 **Addresses**
IPv4: 1 IPv6: 2 MAC: 1



Wi-Fi Controllers

EtherScope can discover SNMP enabled Wi-Fi controllers, including Cisco and Aruba Wi-Fi Controllers.

 **Discovery**

 **Cisco2500WLC**
Wi-Fi Controller

Name
SNMP: Cisco2500WLC



Address
IPv4: 10.250.3.235 (Reachable)
"MAC: Cisco:ece1a9-556c80

Attributes: Discovered via SNMP, Transparent Switch
AP Capacity: 75

 **APs** 2 >

 **SSIDs** 16 >

 **VLANs** 1 >
1

 **Interfaces** 
Up: 2 Down: 3

Access Points (APs)

The EtherScope discovers APs through wireless packet analysis and SNMP queries with a linked connection through a management or test port.

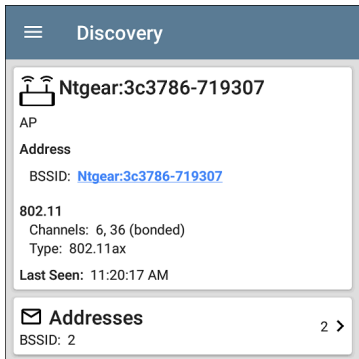

The screenshot shows the 'Discovery' section of the app. At the top, there is a blue header with a hamburger menu icon and the word 'Discovery'. Below this, a card displays information for an AP. The card has a white background and a grey border. It starts with a wireless router icon and the text 'Ntgear:3c3786-719307'. Below that, it says 'AP'. Under the heading 'Address', it lists 'BSSID: [Ntgear:3c3786-719307](#)'. Further down, it shows '802.11' with sub-details: 'Channels: 6, 36 (bonded)' and 'Type: 802.11ax'. At the bottom of this card, it says 'Last Seen: 11:20:17 AM'. Below the main card, there is another section titled 'Addresses' with an envelope icon, showing 'BSSID: 2' and a '2 >' indicator.

See also [APs in the Wi-Fi analysis app](#).

Wi-Fi Clients

Wireless clients are discovered through wireless packet analysis and SNMP queries with a linked connection through a management or test port.

☰ Discovery

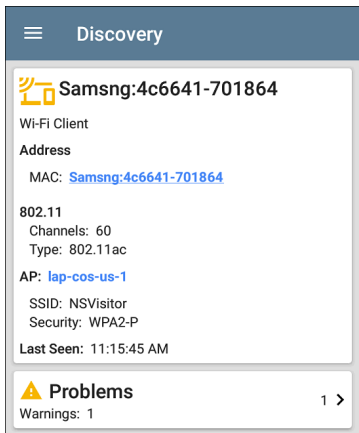
 **Samsng:4c6641-701864**

Wi-Fi Client

Address

MAC: [Samsng:4c6641-701864](#)

802.11

Channels: 60
Type: 802.11ac

AP: [lap-cos-us-1](#)

SSID: NSVisitor
Security: WPA2-P

Last Seen: 11:15:45 AM

 **Problems** 1 >

Warnings: 1

See also [Clients in the Wi-Fi analysis app](#).

VoIP Phones

VoIP discovery provides visibility into the VoIP and layer 2/3 configuration of the network.

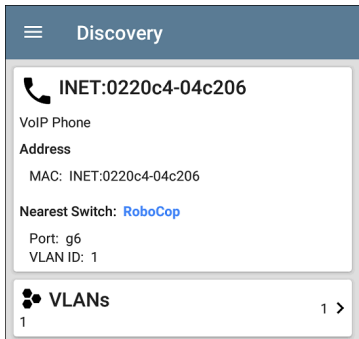

The screenshot shows the Discovery App interface. At the top is a dark blue header with a hamburger menu icon on the left and the word "Discovery" in white. Below the header is a white card with a grey border. The card contains a phone icon, the text "INET:0220c4-04c206", and the label "VoIP Phone". Underneath is the "Address" section with "MAC: INET:0220c4-04c206". The "Nearest Switch" is listed as "RoboCop" in blue. Below that, "Port: g6" and "VLAN ID: 1" are shown. At the bottom of the card is a "VLANs" section with a cluster icon, the number "1", and a right-pointing arrow.

Discovery

 **INET:0220c4-04c206**

VoIP Phone

Address

MAC: INET:0220c4-04c206

Nearest Switch: [RoboCop](#)

Port: g6
VLAN ID: 1

 **VLANs** 1 >

Printers

The EtherScope identifies IP printers via the SNMP Printer MIB and IPX printers via diagnostic requests and queries.

 **Discovery**

 **TOSHIBA e-STUDIO3005AC**
Printer
Name
SNMP: TOSHIBA e-STUDIO3005AC
mDNS: MFP12073521
NetBIOS: MFP12073521
Address
IPv4: 143.131.143.43 (Reachable)
IPv6: fe80::280:91ff:feb8:3a31
MAC: Tokyo:008091-b83a31

 **Problems** 1 >
Warnings: 1

 **Addresses** 3 >
IPv4: 1 IPv6: 2 MAC: 1

 **Interfaces** 2 >
Up: 2 Down: 0

 **SNMP**



SNMP Agents

SNMP agents are discovered using SNMP queries. See [SNMP Configuration](#).

NOTE: If EtherScope cannot discover the SNMP agents on your devices, they may be connected to another subnet, like a management subnet. Solve this issue by adding the subnet to [Extended Ranges](#).

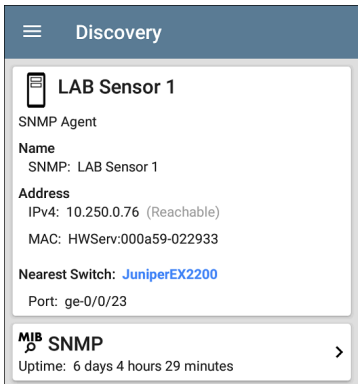

The screenshot shows the 'Discovery' section of the app. At the top, there is a blue header with a hamburger menu icon and the word 'Discovery'. Below this, a card displays information for 'LAB Sensor 1', which is identified as an 'SNMP Agent'. The card lists the following details: Name (SNMP: LAB Sensor 1), Address (IPv4: 10.250.0.76 (Reachable) and MAC: HWServ:000a59-022933), and Nearest Switch (JuniperEX2200) with Port (ge-0/0/23). At the bottom of the card, there is a section for 'MIB SNMP' with an uptime of 6 days 4 hours 29 minutes and a right-pointing arrow.

Discovery

 **LAB Sensor 1**

SNMP Agent

Name
SNMP: LAB Sensor 1

Address
IPv4: 10.250.0.76 (Reachable)
MAC: HWServ:000a59-022933







Nearest Switch: [JuniperEX2200](#)
Port: ge-0/0/23

MIB SNMP >
Uptime: 6 days 4 hours 29 minutes

See also [SNMP Details](#).

Network Tools

The EtherScope can also identify other NetAlly network testers (EtherScope, AirCheck G2, OneTouch AT, LinkRunner (AT and G2), and Test Accessory).

Discovery (122/708)		
1	Device Type	
 fe80::2c0:17ff:fe53:138	EtherScope nXG	NetAlly-530138
 fe80::2c0:17ff:fe53:146	EtherScope nXG	NetAlly-530146
 10.250.3.147	AirCheck G2	NetAlly-350593
 NetAlly:00c017-353246	AirCheck G2	NetAlly-353246
 10.250.2.117	LinkRunner G2	NetAlly-c50070
 10.250.2.132	Test Accessory	NetAlly-330e87

The image above shows several NetAlly tools as they appear in the main Discovery list.

EtherScope displays all the information it can gather about each tool on the Details screen.

☰
Discovery



10.250.2.240

LinkRunner G2

Address

IPv4: 10.250.2.240 (Reachable)

IPv6: fe80::2c0:17ff:fec5:88

MAC: NetAlly:00c017-c50088

Nearest Switch: [PV_Mike_NetgearGS110TP](#)

Port: g6

VLAN ID: 500

 **Addresses**
2 >

IPv4: 1 IPv6: 1 MAC: 1

 **VLANs**
1 >

500

Hosts/Clients

Other hosts and clients are discovered by traffic monitoring and querying. If a host cannot be identified as belonging to one of the other categories (Switch, Router, VoIP device, etc.) then it is categorized as Host/Client.

 **Discovery**

 **ubuntu**

Host/Client

Name
mDNS: ubuntu

Address
IPv4: 10.250.2.109 (Reachable)
IPv6: 2001:c001:c0de:500:b844:4388:4fb7:4506
MAC: ORICO:f01e34-1fbaa4

Nearest Switch: [PV_Mike_NetgearGS110TP](#)
Port: g3
VLAN ID: 500

 **Addresses** 4 >
IPv4: 1 IPv6: 3 MAC: 1

 **VLANs** 1 >
500

NOTE: A MAC address that begins with LocalAdm indicates that the address has been locally randomized to prevent unauthorized tracking.



Discovery

**localAdm:227367-a99246**

Wi-Fi Client

AddressMAC: [localAdm:227367-a99246](#)**802.11**

Channels: 48

Type: --

AP: [localAdm:decbac-51a778](#)

SSID: ngenius&sniffer

Security: WPA2-E

Device Names and Authorization

Assigning a Name and Authorization to a Device

The Wi-Fi and Discovery apps provide the option to assign a **Name and Authorization** to any discovered device with a MAC Address or BSSID.

Assigning a User Name and/or Authorization status does not change any of the information on the actual device, only how the device's information displays on the EtherScope on which the Name and Authorization are assigned.

You only need to assign a Name and/or Authorization to one BSSID or MAC address for a device with multiple addresses. Names and Authorizations are saved in the internal authname.txt file and remain set as the unit powers off and on.

This feature allows you to quickly identify your known devices and categorize them with the following statuses:

- **Authorized:** For devices approved for use on your network
- **Neighbor:** For devices owned and controlled by neighboring organizations
- **Flagged:** To give visibility to a specific device
- **Unknown:** For devices that have not been identified or classified
- **Unauthorized:** For devices that should not be on the network and may present a security risk
- **Unspecified:** Default unassigned Authorization status

While the Authorization statuses are designed with these intended meanings, you can use them however you like for your purposes.

Once set, the custom User Name is shown in other NetAlly apps wherever device information is displayed. The Authorization is displayed in the Discovery and Wi-Fi apps.

You can sort and filter by the assigned Authorization in the Wi-Fi and Discovery apps. When a list is sorted by Authorization (in normal sort

order), the devices with Authorizations of highest concern appear at the top. The image below shows a list screen sorted this way:

The screenshot shows a list of Wi-Fi BSSIDs. The header is 'Wi-Fi - BSSIDs (150)'. Below the header, there are icons for a filter (funnel) and a sort (upward arrow), followed by a dropdown menu set to 'Authorization'. The list contains four entries:

Authorization	BSSID	Device	Channel	Signal Strength
Unauthorized	Ntgear:3c3786-719306	Nighthawk 802.11ax 5GHz	CH: 36	-33 dBm
Neighbor	Cisco:b83861-84aaf0	Cisco WEP64 SA	CH: 36	-82 dBm
Neighbor	Cisco:b83861-84aaf0	CiscoQATest-mañana	CH: 1	-67 dBm
Authorized	Cisco:78bc1a-0fd908	[NGP-004]	CH: 36	-64 dBm

Applying a Name and/or Authorization

Access the **Name and Authorization** function from the floating action menu  on a [Discovery Details screen](#) or a [Wi-Fi Details screen](#) for a [BSSID](#) or [Client](#).

NOTE: When applying an Authorization to a device with multiple BSSIDs or MAC addresses, the Authorization status is only

applied to the MAC address or BSSID displayed on the Details screen, as shown in this section.

1. Tap the **FAB** on a Discovery or Wi-Fi Details screen for a device with a discovered MAC/BSSID.

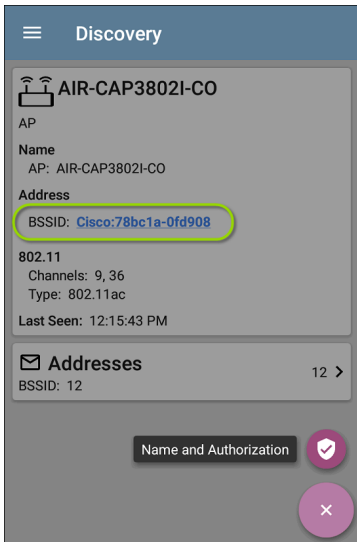

The example above shows an AP's Details screen in the Discovery app.

2. Select **Name and Authorization** to open the dialog.

Name and Authorization

MAC Address: Cisco:78bc1a-0fd908

User Name: Conference Room AP

Authorization

Authorized

Neighbor

Flagged

Unknown

Unauthorized

Unspecified

CANCEL **OK**

3. In the Name and Authorization dialog, tap the **User Name** field to enter a customized name, if desired. In the image above, the user has entered the name "Conference Room AP."

NOTE: It is possible to *either* enter a user name or select an Authorization. You do not have to do both.

4. Select the radio button to assign an **Authorization** status as needed.
5. Tap **OK** to apply.

Once applied, the User Name and Authorization are displayed on the Discovery Details screen.

The screenshot shows the 'Discovery' app interface. At the top is a blue header with a hamburger menu icon and the word 'Discovery'. Below this is a card for 'Conference Room AP' with a Wi-Fi icon. The card contains the following information: 'AP', 'Name' (with a green highlight box around 'User: Conference Room AP' and 'AP: AIR-CAP3802I-CO'), 'Address' (with a green highlight box around 'BSSID: Cisco:78bc1a-0fd908' and 'Authorization: Authorized'), '802.11', 'Channels: 9, 36', 'Type: 802.11ac', and 'Last Seen: 12:17:22 PM'. At the bottom of the card is a section titled 'Addresses' with an envelope icon, 'BSSID: 12', and a right arrow next to the number '12'.

☰ Discovery

 **Conference Room AP**

AP

Name

User: Conference Room AP
AP: AIR-CAP3802I-CO

Address

BSSID: [Cisco:78bc1a-0fd908](#)
Authorization: Authorized

802.11

Channels: 9, 36
Type: 802.11ac

Last Seen: 12:17:22 PM

 **Addresses** 12 >

BSSID: 12

The user-assigned name for the AP and Authorization for the BSSID also appear on the Wi-Fi BSSID Details screen, as shown below.

Wi-Fi - BSSID

 **Cisco:78bc1a-0fd908**
BSSID

SSID: [AmNaCa](#)

AP: [Conference Room AP](#)
BSSID: 78bc1a-0fd908
Authorization: Authorized

802.11

Channel: [9](#)

Types: n, g, b
Signal: -60 dBm
SNR: 33 dB
Security Type: WPA2-P

Last Seen: 2:30:38 PM

↑↓ Rates and Capabilities >

📶 Clients 0 >





📈 RF and Traffic Statistics >

NOTE: If different Authorization statuses are assigned for different BSSIDs or MAC addresses on the same device, the Authorization of highest concern appears on the device's Details screens.

Changing or Clearing a User Name or Authorization

Open the Name and Authorization dialog again *for the same BSSID or MAC address* on a device to reassign or clear the assigned User Name or Authorization. If the Name or Authorization do not update as expected after a few minutes, you may have assigned them to multiple addresses for the same device.

To view all assigned Authorizations for a device, open the Discovery or Wi-Fi Details screen for the device and view the Addresses or BSSIDs screen. Then, sort by Authorization.

Addresses (14)		
Authorization		
 Cisco:b83861-84aaf3	CH: 36	>
Flagged	Cisco WEP128 OA	
 Cisco:b83861-84aaf1	CH: 1	>
Neighbor	Cisco WEP64 OA	
 Cisco:b83861-84aafc	CH: 1	>
Authorized	Cisco WEP128 OA	
 Cisco:b83861-84aaf0	CH: 1	>
Neighbor	Cisco WEP64 OA	

To reset a device's User Name and/or Authorization to the unassigned defaults, open the Name and Authorization dialog, clear the User Name field and leave it blank, and select the **Unspecified** Authorization. Then, tap **OK**.

Revising or Importing authname.txt

Custom Names and Authorizations are stored in the **authname.txt** file in the EtherScope's internal storage **.settings** folder, accessible from the [Files](#) app.

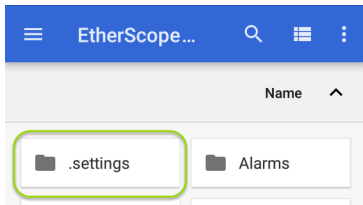

NOTE: In the Files app, you may need to tap the action overflow icon  at the top right and select **Show Internal Storage** to navigate to the folder and sub-folders, as shown above.

If desired, you can manually edit this file on the EtherScope unit, or you can create a new auth-name.txt file on a PC and import it onto your unit in the same file location. (You can also push authname.txt files from [Link-Live](#) to your test unit.)

NOTE: Your EtherScope nXG can parse ? wildcard characters in the authname.txt file (although * wildcard characters are not allowed).

The default `authname.txt` file on your unit contains instructions on how to format your Name and Authorization entries:

- Each line defines one MAC/BSSID in the format:
`MAC/BSSID, [Authorization][, Customized Name]`
- Authorization is case insensitive and can be one of these strings:
 - Authorized
 - Neighbor
 - Flagged
 - Unauthorized
 - Unknown
 - Unspecified (or blank)
- You can substitute a question mark `?` for a MAC digit to match any value for that digit.

A sample `authname` file could look like this:

```
00c017-330ea3, Authorized, iPerf3-server  
bc:e9:2f:41:df:b4, Authorized, HP-Deskjet  
b827eb-???????, Unauthorized, Raspberry-PI
```

7c:10:c9:?:?:?:?, Neighbor, ASUS-AP
 18b169-c84600, Flagged, Who is this?

The line 18b169-c84600, Flagged, Who is this? would result in a Discovery details for the device as follows:

	Who is this?	-38 dBm	>
Flagged		Sonicw	

To edit the authname.txt file on the EtherScope, third-party apps, such QuickEdit Text Editor, are available from the NetAlly [App Store](#) .

For help importing a file, see the [Managing Files](#) topic.

NOTE: After importing and overriding the authname.txt file, NetAlly recommends [Refreshing Discovery](#) in the Discovery app or restarting your unit.

Discovery Settings

Discovery configurations include SNMP settings, Community Strings and the order in which they are used, Credential Sets, Ports, Extended Ranges, and process intervals.

Access the Discovery settings screen by sliding out the left-side [navigation drawer](#) or tapping the menu icon , and selecting **Discovery Settings**.



Discovery



Discovery Settings



Problem Settings



TCP Port Scan Settings



General Settings



Feature Access



About

(Tap here to skip to [Problem Settings](#), [TCP Port Scan](#), or back to [General Settings](#).)

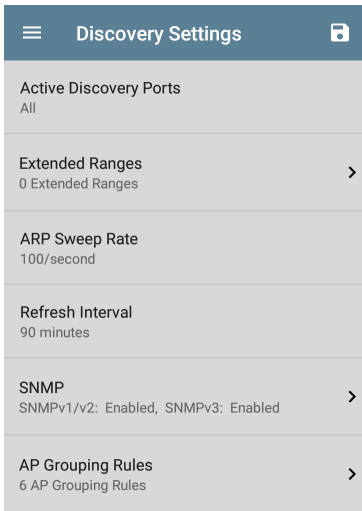



Discovery Settings	
Active Discovery Ports	All
Extended Ranges	0 Extended Ranges
ARP Sweep Rate	100/second
Refresh Interval	90 minutes
SNMP	SNMPv1/v2: Enabled, SNMPv3: Enabled
AP Grouping Rules	6 AP Grouping Rules

To adjust Discovery Settings:

1. On the **Discovery Settings** screen, tap each field described in this topic, as needed, to

select or enter your required configuration elements.

2. When you finish configuring, tap the back button  to return to the main [Discovery List screen](#).
3. Then, [Refresh Discovery](#) from the action overflow menu  to apply the new configuration.

You can load, save, import, and export configured Discovery settings by tapping the save button  on this screen.

- **Load** opens a previously saved Discovery configuration.
- **Save As** saves the current configuration with an existing name or a new custom name.
- **Import:** Import a previously exported settings file.
- **Export Selected** or **Export All:** Create an export file of current settings, and save it to internal or connected external storage.

See [Managing Testing App Settings](#) for more instructions.

After you have saved a configuration, the custom name you entered appears in the title of the Discovery Settings screen. In the image below, a user has saved a custom configuration named "South Campus," which replaces the "Discovery Settings" screen title.

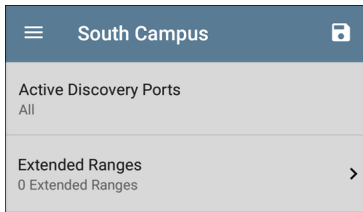

Active Discovery Ports

Tap **Active Discovery Ports** to select which port Discovery uses to gather data. (Discovery uses all of the ports by default. Uncheck them to limit which ports are used.) Discovery runs through the enabled ports only if an active network link is available. See [Selecting Ports](#) for explanations of the different ports.

Extended Ranges

The Extended Ranges screen allows you to enter addresses of non-local subnets on which you want the Discovery process to run. Discovery sweeps all of the enabled Extended Ranges for devices, whether directly connected or off-net. The EtherScope performs Ping sweeps on subnets that are not directly connected and ARP sweeps on connected subnets.

When the SNMP agents are on a subnet that is separate from the hosts (PC's and servers) subnet, additional networks must be configured for discovery:

- The network address of the remote subnet you want to discover, meaning the host (PC and server) network.
- The network address of the switch and router SNMP agents in the remote subnet, e.g. a management subnet.

Configure both **SNMP Credential Sets** and **Extended Ranges** to ensure that the EtherScope always discovers management subnets, regardless of your network port connections.

Tap the field to open the Extended Ranges list screen.

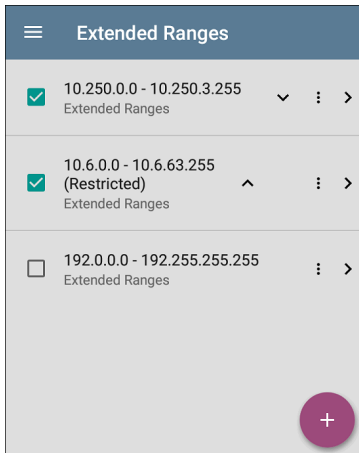

- Check or uncheck the boxes to include or exclude an extended range from the current Discovery configuration. Unchecked Extended Ranges do not affect the default Discovery behavior in the current

configuration, but they may be used in other Discovery configurations (like Community Strings and Credentials).

- Tap any Extended Range's row to edit its address and subnet.
- Tap the FAB  to add new extended ranges.

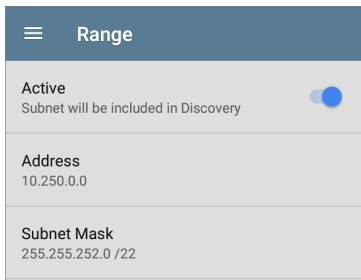

Range	
Active	<input checked="" type="checkbox"/>
Subnet will be included in Discovery	
Address	10.250.0.0
Subnet Mask	255.255.252.0 /22

Active vs. Restricted Subnets

For each configured Extended Range, you can tap the toggle button to switch from **Active** to **Restricted**. Discovery is performed on Active Ranges. Setting a Range to **Restricted** disables the discovery process on that network or subnet,

meaning the EtherScope will *not* communicate with devices within the restricted range.

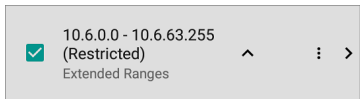

- Restricted Ranges take precedence regardless of the order in which they are listed on the Extended Ranges screen.
- You can Restrict a part of a configured Active Extended Range.
- You can also restrict a single device, whether it is part of an Active Range or not. To enter a single device that you do not want discovered, enter its IP address in the Address field, and set the Subnet Mask field to 255.255.255.255.

Address

Tap the **Address** field to enter or select an IP address range.

Tap the drop-down menu to select a previously Discovered Subnet. The Address field is automatically populated with your selection.

Subnet Mask

Tap this field to select a subnet mask. If you select an already Discovered Subnet, the Subnet Mask is also pre-populated.

ARP Sweep Rate

Tap the ARP Sweep Rate field to select a rate between 5 and 100 ARP requests per second.

This setting can prevent the EtherScope from shutting down ports that sense too many ARPs being sent.

Refresh Interval

This setting controls the time between runs of the Discovery process. By default, Discovery runs every 90 minutes. Tap the **Refresh Interval** field to select a different interval, up to 8 hours.

The **Manual** option turns off regular automatic Discovery, and the process refreshes only if you

select **Refresh Discovery** from the main Discovery list screen.

SNMP Configuration

The MIB (Management Information Base) of SNMP managed devices contains information such as device configuration, interface configuration and statistics, SNMP tables (like host resource and route tables) and VLAN details. Through the Discovery process, the EtherScope interrogates MIBs to determine the device type, ports, connected subnets, and other data.

SNMP credentials are required to communicate with the SNMP agents on your interconnect devices, such as switches and routers. The Discovery Settings allow you to enter the SNMP community strings and credential sets the EtherScope uses to communicate with those devices.

SNMPv1/v2

Tap the toggle button to enable or disable SNMPv1 and v2 queries. This setting is enabled

by default and uses the Community Strings configured in the next setting.

Community Strings



Tap this field to open the Community Strings list screen and add, edit, or remove community strings.

Community Strings	
<input checked="" type="checkbox"/>	cos dev sw1 Community Strings
<input checked="" type="checkbox"/>	Default Community String: public Community Strings
<input type="checkbox"/>	Default Community String: private Community Strings

The EtherScope uses the checked strings in the order shown on this screen. If it does not receive a response from the queried device using one string, it sends the next string.

NOTE: This screen and others in the Discovery settings operate much like the [AutoTest Profile Group screen](#).

On the Community Strings screen, you can perform these actions:

- Check or uncheck the boxes to include or exclude a string from use in the current Discovery configuration.
- Tap the up and down arrows  to change the order in which the EtherScope uses the strings to query a device.
- Tap the action overflow icon  to **Duplicate** or **Delete** a Community String.

CAUTION: Deleting a string removes it from all saved Discovery configurations. To remove a string from the current Discovery configuration only, simply uncheck it.

- Tap the FAB  to add new Community Strings.
- Tap any Community String's row to edit the string and its description.

TIP: To minimize discovery time, uncheck or delete all unused community strings, as every failed query extends the discovery time. You can also arrange the community strings in the order they are used most.

SNMPv3

Tap the toggle button to enable or disable SNMPv3 queries. This setting is enabled by default and uses the Credentials configured in the next setting.

NOTE: If this setting is enabled, but no SNMPv3 credentials are configured, the Ether-Scope discovers the engine IDs of all SNMPv3 agents. This is a good way to discover if a device supports SNMPv3.

Credentials

Tap this field to open the Credentials list screen.

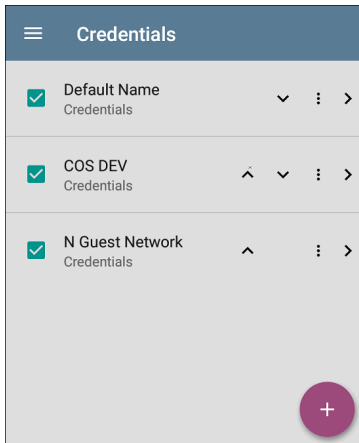

This screen interface works like the Community Strings screen above. EtherScope uses the Credentials in the order shown.

- Check or uncheck the boxes to include or exclude a set of Credentials from use in the current Discovery configuration.
- Tap a row to edit its credentials.

- Tap the FAB  to add new credentials.

Credential Sets	
Name	Default Name
Username	
Authorization Type	None
Authorization Password	
Privacy Type	None
Privacy Password	

On the Credentials Sets screen, tap each field to select or enter the credentials required.

Name

Tap the **Name** field to enter a custom name for the Credential Set.

Username

Tap to enter the SNMPv3 username.

Authorization Type and Password

EtherScope Discovery supports two SNMPv3 Authorization types: HMAC-SHA and HMAC-MD5. If Authorization is required, enter the appropriate password.

Privacy Type and Password

EtherScope Discovery supports four Privacy Types: CBC-DES, AES-128, AES-192, AND AES-256. If needed, enter the appropriate Privacy Password.

SNMP Query Delay

This function controls how long your EtherScope waits between SNMP queries to key tables that can cause CPU spikes in the SNMP agents, including the ARP cache, IP address table, routing tables, and FDB tables.

The default SNMP Query delay is No Delay. When querying the key large tables, the EtherScope asks for more data as soon as a response has

been received. You can select a 1 or 5 second delay if needed.

Devices Discovered Through Other Devices

By default, EtherScope discovers devices from SNMP tables of other devices. If you do not want Discovery to automatically find devices from SNMP tables of the device types listed here, you can uncheck their boxes.

Devices Discovered Through Other Devices

- Routers and Subnets
- Switches
- VoIP Devices
- Wi-Fi Clients
- Virtual Machines

CANCEL **OK**

Routers and Subnets

When the Routers and Subnets checkbox is enabled, any discovered routers are included in discovery results. In addition, if Discovery has SNMP access to a discovered router, its routing tables are read, and the next hop routers are added to the Discovery list. If any local subnets are available in the routing tables, these are also added to the Subnets list. This process continues until all the available SNMP credentials are tried for the added routers.

NOTES: Discovery does not sweep every discovered subnet; discovered subnets are only added to the subnets list. To perform discovery in a specific subnet, see **Extended Ranges** above.

If another site has routers you want to discover using this process but there isn't a local next hop link from this site, you can add one of the routers of that site to discovery. The process then runs from that router and finds the routers on that site as well. Add the subnet of the router or just the

router's IP address with a mask of /32 to Extended Ranges.

Switches

When the Switches checkbox is enabled, discovery adds any switches that it finds in SNMP neighbor tables of other devices to the Discovery list.

For example, when EtherScope is reading the CDP and LLDP caches of one switch, it contains other switches. If this option is enabled, the EtherScope adds those other switches, even if they are not in discovery ranges.

NOTE: To Discover switches at another site, add one of the switches of that site to Discovery Extended Ranges.

VoIP Devices

When the VoIP Devices checkbox is enabled, discovery adds any VoIP devices that it finds in SNMP tables of other devices regardless of the subnet. These are usually found in the LLDP-MED tables of the switches. Enabling the Switches option provides the best chance of finding all your VoIP devices.

Wi-Fi Clients

When the Wi-Fi Clients checkbox is enabled, discovery adds any wireless clients it finds in SNMP tables of APs and Wireless LAN Controllers. Enabling this option along with Switches provides best chance of finding all Wi-Fi clients.

NOTE: Enabling Wi-Fi Clients here may cause Wi-Fi devices to show in Discovery that do not appear in the [Wi-Fi analysis app](#) because Wi-Fi analysis only shows what it detects on wirelessly transmitted packets.

Virtual Machines

When the Virtual Machines checkbox is enabled, discovery adds any virtual machines that it finds in SNMP tables of other devices. These are usually found in the ESX host > SNMP tables. Adding the subnets of your ESX hosts to Extended Ranges helps with finding your virtual machines.

Device Health Interval

Discovery automatically runs a set of network health tests to search for network Problems,

such as high utilization, discards, or errors on all discovered interfaces and device resources.

The selected time Refresh Interval is the minimum time between each run of the Device Health tests. Tap the field to disable Device Health testing or to change the interval from the default of 10 minutes to 30 or 60 minutes.

Disabling the Device Health testing affects the types of Problems that Discovery can detect.

See also [Problem Settings](#).

Auto AP Grouping Rules

Auto AP Grouping Rules

6 AP Grouping Rules



This feature allows you to adjust the AP Grouping Rules that control how the EtherScope groups BSSIDs with their Access Points, such that they are grouped appropriately for your AP types and environment.

For example, if BSSIDs from different APs are being grouped together inaccurately, you can disable the rule that is causing the grouping. If



your AP manufacturer uses a BSSID variation scheme that is not covered by one of the six default rules, you can add a new rule.

Tap the setting to open the AP Grouping Rules list screen. The image below shows the six default AP Grouping Rules on the EtherScope. The **Prefix filters** in all of the default grouping rules are set to 000000-000000.

AP Grouping Rules			
<input checked="" type="checkbox"/>	Grouping 1 FFFFFFFFFFC0	▼	⋮ >
<input checked="" type="checkbox"/>	Grouping 2 00FFFFFFFFFF	▲ ▼	⋮ >
<input checked="" type="checkbox"/>	Grouping 3 FFFFFF0FFFFF	▲ ▼	⋮ >
<input checked="" type="checkbox"/>	Grouping 4 00FF0FFFFFFF	▲ ▼	⋮ >
<input checked="" type="checkbox"/>	Grouping 5 0DFFFFFF0FFFF	▲ ▼	⋮ >
<input checked="" type="checkbox"/>	Grouping 6 F0FFFFFFFFF0	▲	⋮ >



As with other settings list screens, you can enable or disable, add, delete, and edit the grouping rules from this screen.

- Check or uncheck the boxes to include or exclude a rule from use in the current Discovery configuration.
- Tap the action overflow icon  to **Duplicate** or **Delete** a rule.
CAUTION: When you delete a rule, you delete it from all saved Discovery configurations. To remove a rule from those used by the current Discovery configuration, simply uncheck it.
- Tap the FAB  to add a new rule.
- Tap any rule's row to edit it.

AP Grouping Rules	
Name	Grouping 1
Prefix filter	000000000000
Filter mask	FFFFFFFFFC0

Name

If desired, enter a custom name for a default or new rule. If you intend to use a Prefix filter, a best practice would be to name the rule with the AP manufacturer's name.

Prefix filter

Use the **Prefix filter** to create a rule for a specific AP manufacturer's BSSID scheme, meaning a rule for just one AP manufacturer prefix. The default rules all contain a default Prefix filter of 000000-000000.

If a Prefix filter is non-zero, its second and third bytes are compared to discovered BSSIDs before the **Filter mask** (described below) is applied. These two bytes must match exactly, or the two BSSIDs are not grouped together. This behavior allows you to specify a fairly open Filter mask, because the mask applies only to one manufacturer.

For example, you could have Cisco APs with BSSIDs that all start with b83861. By specifying a Prefix filter of 003861-000000, you limit the grouping rule to just those APs.

Filter mask

The Filter mask specifies what parts of the BSSIDs are compared when determining AP groupings.

For example, default **Grouping Rule 1** has a Filter mask of FFFFFFFF-FFFFC0, so any BSSIDs that vary only by the lower six bits are grouped together.

Problem Settings

The Problem settings determine which issues are detected and displayed by *both* the Discovery and [Wi-Fi Analysis](#) apps as well as the thresholds for enabled problems, such as Packet Discards and Utilization.

Access the Problem Settings screen by sliding out the left-side [navigation drawer](#) or tapping the menu icon  in the Discovery app, and selecting **Problem Settings**.

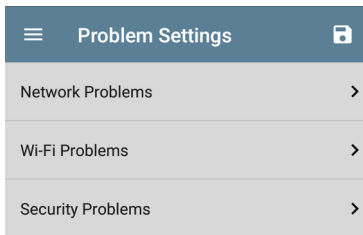

Problems are categorized as Network, Wi-Fi, or Security.



NOTE: The Wi-Fi Problems configured here also control the [Problems](#) detected and displayed in the [Wi-Fi Analysis](#) app.

As with [Discovery Settings](#), you can save, load, import, and export configured Problem Settings by tapping the save button  on this screen. See [Managing Testing App Settings](#) for more instructions.

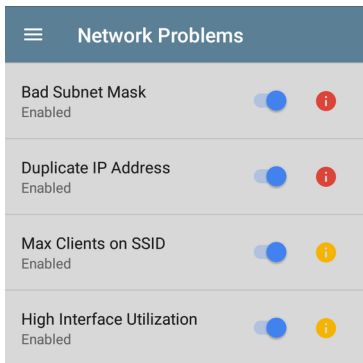
Tap the row for each to enable or disable the problem types and set thresholds where applicable.



All Problem types are enabled by default. Tap the toggle button to the right to disable each one.

- Tap the red  or yellow  information icons to the right of each Problem to read a detailed description and recommended actions.
- **Red** icons indicate Failure conditions.
- **Yellow** icons indicate Warning conditions.

When you finish configuring, tap the back button  to return to the main Discovery screen.

TCP Port Scan Settings

The TCP Port Scan feature checks for open ports on the current device. To run scan, tap the **FAB** on the **Discovery Details** screen, and then tap **TCP Port Scan**. The EtherScope scans many ports simultaneously and reports the open port's numbers.

Access the TCP Port Scan Settings by sliding out the left-side **navigation drawer** or by tapping the navigation menu icon , and then selecting **TCP Port Scan Settings**.

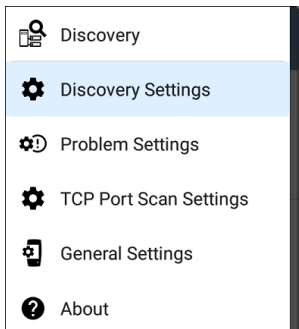

This displays the TCP Port Scan Settings screen.

TCP Port Scan Settings	
Interface	Any Port
Scan List	1-2049, 3268-3389, 3535, 5000-6005, 8008-8443
Timeout Threshold	1 s

Interface: Tap the field to select the EtherScope port from which the port scan runs. (See [Selecting Ports](#) for explanations of the different ports.)

Scan List: Tap this field to edit the list of port numbers that get tested during the port scan. You can enter port numbers or ranges, separated by commas.

Timeout Threshold: Tap this field to select a value for how long the EtherScope waits for a response from each port or to enter a custom value. The scan ends after all the ports in the Scan List have had this amount of time to

respond, and then the results screen lists the ports that responded within the threshold.

See also the [TCP Port Scan results card and screen](#).



Wi-Fi Analysis App

The Wi-Fi Analysis app scans the wireless channels in your environment to discover and gather data about the devices and traffic on your Wi-Fi networks. Wi-Fi discovery begins when you power on the EtherScope, and measurements update with each channel scan cycle.

The EtherScope nXG supports 802.11a/b/g/n/ac/ax technologies. EtherScope can also detect and indicate the 802.11ax media type (known as Wi-Fi 6) being used on APs and Clients, as reported in the wireless management frames.

The Wi-Fi app features separate screens that list and display characteristics of the different devices and elements of your wireless environment. Tap a link below to go directly to the description of the screen listed:

- [Channels Map](#)
- [Channels](#)
- [SSIDs](#)
- [APs](#)
- [BSSIDs](#)
- [Clients](#)
- [Bluetooth](#)
- [Interferers](#)

Wi-Fi Analysis and Discovery

Wi-Fi Analysis uses the [Wi-Fi Test Port](#) to scan the channels and acquire information about your wireless networks. If the Wi-Fi Test Port is linked (for instance after running a [Wi-Fi AutoTest Profile](#)), the port unlinks and resumes scanning when you open the Wi-Fi Analysis app.

When EtherScope links to a network, Discovery can obtain information from network layers 3 and above, such as IP addresses, Protocols, and SNMP data.

Therefore, the information Wi-Fi Analysis is able to display also depends on configured [Discovery Settings](#), such as [SNMP Community Strings](#) and [Credentials](#), [Active Discovery Ports](#), [Extended Ranges](#), and [Device Health](#) testing.

Wi-Fi App Screens

To switch between the different Wi-Fi app screens, tap the menu icon  (or swipe right) to open the left-side [navigation drawer](#).

 Channels Map

 Channels (9 active)

 SSIDs (16)

 APs (14)

 BSSIDs (34)

 Clients (42)

 Bluetooth (3)

 Interferers (0)



 General Settings

 About

The Wi-Fi app's navigation drawer displays a real-time count (in parentheses) of each wireless component EtherScope has detected. Tap an option to open the corresponding screen.

NOTE: The **General Settings** for Wi-Fi control which channels and bands are scanned to populate the Wi-Fi screens. See the [General Settings](#) topic for more explanation.

Wi-Fi App List Screens

The Wi-Fi app screens, except for Channels Map, display a list of discovered items, much like a [Discovery App list screen](#). You can [Filter](#)  and [Sort](#)  the list by different characteristics and tap a network component's card to view its details.

The example image below shows the APs screen with common Wi-Fi app functions:

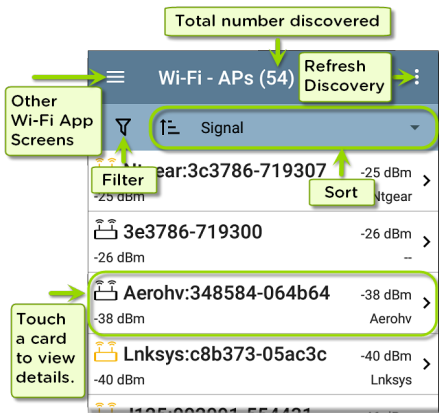

As with AutoTest and other EtherScope screens, the icons in Wi-Fi analysis change color to indicate a **Warning** or **Failure** condition. The app also displays icons in **Blue** to indicate Problem-related information that does not constitute a warning or failure, and **Green** to indicate that a previous Problem has been resolved.

NOTE: To adjust the **Problem Settings**, access them from the Discovery app's left-side **navigation drawer**. Problem Settings in the

Discovery app are also applied to the Wi-Fi Analysis app.

The Wi-Fi list screens, and other app screens with long lists, support fast scrolling. Touch and drag the scrollbar handle to the right of the list to scroll quickly up and down.

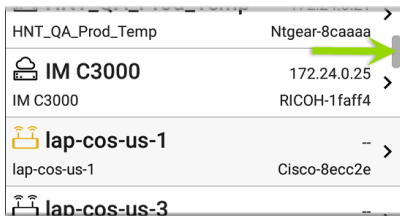

Wi-Fi List Cards

The information displayed on each card varies depending on the selected Sort characteristic and the data the EtherScope was able to discover. For example, a card on the Channels list screen displays the channel number, frequency, connected APs, and utilization.

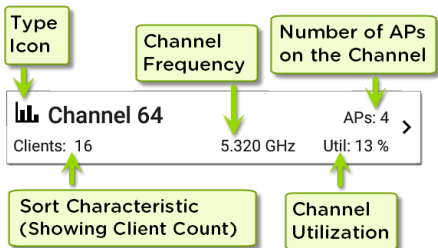

The lower left field displays the characteristic by which the list screen is currently sorted. In the image above, the Channels list is sorted by Client Count.

If a device is grayed out, the EtherScope no longer detects a signal from it. The client card shown below indicates that the "Rspbry" client cannot be detected currently.



The time the device was Last Seen, meaning last detected by the EtherScope, is shown on the device's Details screen.

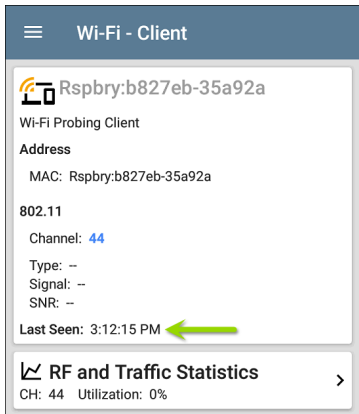

The screenshot shows the 'Wi-Fi - Client' screen in the Wi-Fi Analysis App. At the top, there is a blue header with a hamburger menu icon on the left and the text 'Wi-Fi - Client'. Below the header, the main content area is white and contains the following information: a Wi-Fi icon followed by the MAC address 'Rspbry:b827eb-35a92a', the text 'Wi-Fi Probing Client', the label 'Address' followed by 'MAC: Rspbry:b827eb-35a92a', the text '802.11', 'Channel: 44' (where '44' is in blue), 'Type: --', 'Signal: --', 'SNR: --', and 'Last Seen: 3:12:15 PM'. A green arrow points to the 'Last Seen' text. At the bottom of the screen, there is a grey bar with a line graph icon, the text 'RF and Traffic Statistics', and a right-pointing chevron. Below this bar, it says 'CH: 44 Utilization: 0%'.

Filtering in the Wi-Fi App

Each Wi-Fi Analysis screen has different Filter options that are appropriate for the network component type you are analyzing.

← Channel Filters	
Bands (3)	▼
Devices (1)	▼
SSIDs (70)	▼
APs (55)	▼
BSSIDs (244)	▼
Problems (1)	▼

NOTE: The Channels, AP, BSSID, and Client screens include the ability to filter on Problems.

Tap the filter button  near the top left of the Wi-Fi screens to set filters that control which network components are displayed. You can also filter the **Channels Map > Overlap** screen, as shown below:

← Overlap Filters	
Channels (5)	∨
SSIDs (9)	∨
Signal (3)	∨
SNR (4)	∨
802.11 Type (5)	∨
Security (3)	∨

The number in parentheses shows how many active network characteristics are detected for each category. (The example shows (5) active Channels, (9) SSIDs, and so on.)

Tap a category to select filters by tapping the checkboxes or radio buttons.

Security (3)	∧
<input type="checkbox"/> WPA2-E (2)	
<input checked="" type="checkbox"/> WPA2-P (9)	
<input type="checkbox"/> WPA-P (5)	

Under each category, the number of discovered APs is shown for each characteristic. (In the example above, there are (3) Security types detected and (9) APs using the WPA2-P Security type.)

In this example, the Overlap screen shows only those APs that fall under your chosen filter parameters.

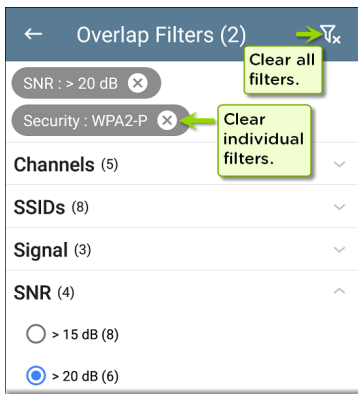

When filters are selected, those active filters are displayed at the top of the Filters screen.

- Tap the ✕ button to the right of each filter to clear it.
- Tap the clear filter icon at the top right to clear all filters.

Back on the Overlap screen, the number of active filters displays to the left of the filter icon, like this: 2 .

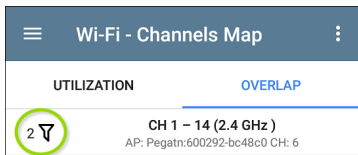

If the screen is a list, like the APs screen below, the screen title shows the number of filtered devices out of the total discovered devices (5 filtered devices out of 16 total).

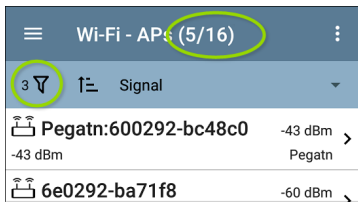



Sorting in the Wi-Fi App

Tap the Sort bar or down arrow to open the Sort drop-down menu. Each list screen supports relevant Sort options based on what you are viewing. The APs screen Sort options are shown below as an example.

The screenshot shows the 'Wi-Fi - APs (55)' screen with a sort menu open. The menu lists the following sorting options:

- Signal
- Name
- Problem
- Mfg Prefix
- SSID Count
- BSSID Count
- Channel Count
- Client Count
- Authorization

The background list shows APs with their respective signal strengths and names:

Signal	Name	Problem	Mfg Prefix	SSID Count	BSSID Count	Channel Count	Client Count	Authorization
-29 dBm	192.168	Bm	ear					
-34 dBm	AsusTk:	Bm	sTk					
-39 dBm	10.24.8.	Bm	icw					
-39 dBm	10.24.8.	Bm	icw					
-40 dBm	10.24.8.	Bm	icw					
-42 dBm	Lnksys:	Bm	sys					
-43 dBm	10.24.8.35							

Select a Sort option to order the list based on your selected characteristic.

Wi-Fi - APs (16)		
Filter	Sort	SSID Count
	Tchclr:7c9a54-be4263	-68 dBm > Tchclr
	SSIDs: 4	
	Pegatn:600292-bc48c0	-42 dBm > Pegatn
	SSIDs: 3	
	Tchclr:7c9a54-be425a	-66 dBm > Tchclr
	SSIDs: 3	

The selected Sort option displays in the Sort bar above the list, and the sort characteristic for each item is shown under the type icon and name. In the image above, the discovered APs are sorted by SSID Count, which is shown below each AP icon.

Tap the sort order icon to switch the sort order between normal and reverse order.

Wireless devices and IDs are sorted in groups. Those with resolved names appear at the top (in normal order), and then devices with only IPv4,

IPv6, and MAC addresses appear below, respectively. Reversing the normal sort order reverses the devices within the groups but does not change the order of the groups.

Refreshing Wi-Fi

Tap the action overflow icon  at the top right of the screen in any of the Wi-Fi screens (Channels Map, Channels, SSID, APs, BSSIDs, or Clients), and select **Refresh Wi-Fi** to clear and repopulate the Wi-Fi app screens with data.

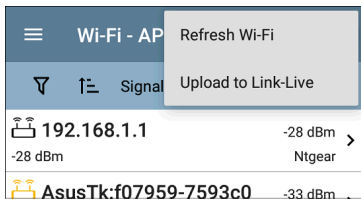

Clearing All Problems

Tap the action overflow icon  at the top right of the screen in any of the Wi-Fi screens (Channels Map, Channels, SSID, APs, BSSIDs, or

Clients), and tap **Clear All Problems** to clear all detected problems on all Wi-Fi lists.

See [Wi-Fi Problems Screen](#) for more information.

Setting Authorization

You can also use the Authorization to sort the BSSID and Clients lists. From the BSSID or Clients list screen, tap the action overflow icon  at the top right and select **Set Authorization** to see how these devices are currently categorized and the number of devices in each category.

Set Authorization

38 of 226 devices selected

- Authorized (0)
- Neighbor (0)
- Flagged (0)
- Unknown (0)
- Unauthorized (0)
- Unspecified (38)

CANCEL

OK

See [Wi-Fi Details Screens](#) for more information.

Uploading Results to Link-Live

Tap the action overflow icon  at the top right of the screen in any of the Wi-Fi screens (Channels Map, Channels, SSID, APs, BSSIDs, or

Clients), and tap **Upload to Link-Live** to send the current Wi-Fi results to the Analysis page  on Link-Live.com.

NOTE: Discovery app results automatically upload with the Wi-Fi results.



Link-Live

by NetAlly



Wi-Fi Snapshot Name

20190812_210303

Comment

3rd floor

Job Comment

Union Hall



SAVE TO ANALYSIS FILES

See the [Link-Live chapter](#) for more information.

[Back to Title and Contents](#)

Wi-Fi Details Screens

Tap any card on a Wi-Fi list screen (SSIDs, APs, BSSIDs, Clients, etc.) to open the Details screen for that device or network ID.

The example below calls out a Client card and its Details screen.

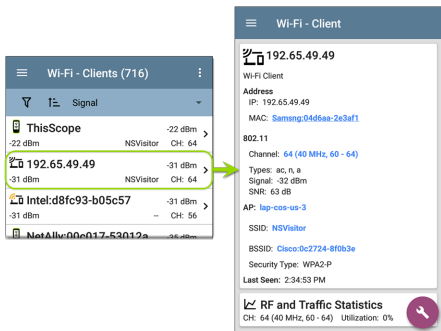

On the Wi-Fi Details screens, you can tap any **blue linked name or address** to open a Discovery or Wi-Fi app screen for the linked device.

NOTE: Non-underlined links open in the same app (in this case Wi-Fi), and [underlined links](#) open in a different app (in this case Discovery).

Each Details screen shows additional information about the selected item, any Problems detected by the EtherScope, and counts for other connected network devices or IDs.

See also [Data Fields on the Top Details Card in the Discovery chapter](#). Many of the Discovery data fields are the same as those shown in Wi-Fi Details.

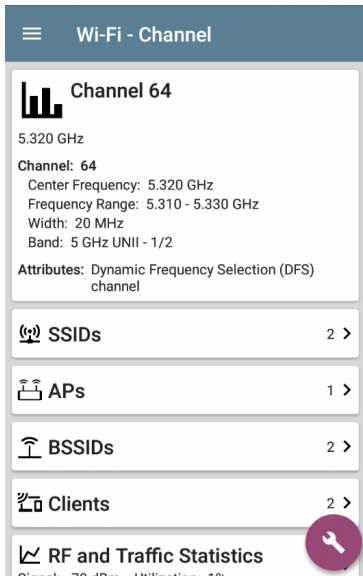

Wi-Fi - Channel

 **Channel 64**

5.320 GHz

Channel: 64

Center Frequency: 5.320 GHz

Frequency Range: 5.310 - 5.330 GHz

Width: 20 MHz

Band: 5 GHz UNII - 1/2

Attributes: Dynamic Frequency Selection (DFS) channel

 **SSIDs** 2 >

 **APs** 1 >

 **BSSIDs** 2 >

 **Clients** 2 >

 **RF and Traffic Statistics**

Signal: 70 dBm Utilization: 10%



The Channel Details screen above shows how many SSIDs, APs, BSSIDs, and Clients are detected on Channel 64. Tap the lower cards in

Wi-Fi Details to open a list screen that is filtered for the network component you are examining.

If you select BSSIDs on the Details screen for Channel 64, the BSSIDs screen opens and filters for BSSIDs found on Channel 64 only.

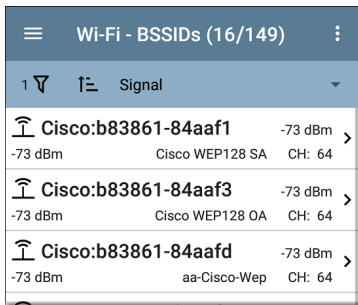

See the topics for each Wi-Fi app screen type (SSIDs, APs, etc.) for more discussion of the corresponding Details screen.

Wi-Fi Problems Screen

If any of the enabled Wi-Fi Problems are detected, the Problems card appears on the Wi-Fi Details screen.

The screenshot shows the 'Wi-Fi - AP' screen. At the top is a blue header with a hamburger menu icon and the text 'Wi-Fi - AP'. Below the header is a card for the access point 'TRENDn:d8eb97-af1e2c'. The card contains the following information: an AP icon, the name 'TRENDn:d8eb97-af1e2c', the type 'AP', the AP ID as a blue link, the manufacturer prefix 'TRENDn', the standard '802.11', supported types 'ac, n, g, a, b', security type 'WPA2-P', signal strength '-54 dBm', and last seen time '3:47:10 PM'. Below this card is a 'Problems' card with a yellow warning triangle icon, the text 'Problems', 'Warnings: 2', and a right-pointing arrow. At the bottom is a partially visible 'SSIDs' card with a signal icon.

The Problems card shows the icon color of the highest severity problem, and the number of detected **Warning**, **Failure**, **Information**, and **Resolved** conditions for the device or network component.

Tap the card to open the Problems screen.

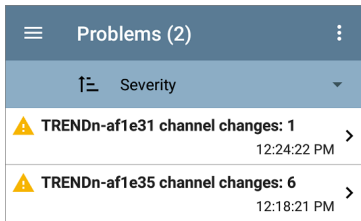

On the Problems list screen, tap the Problem's row to read a detailed description.

You can also tap the sort field to sort the list by **Severity** or by the time when the problem was **First Detected**. To clear a problem, tap the action overflow button  at the top right, and then tap **Clear Problem**.

See [Problem Settings](#) in the Discovery app to select which Wi-Fi Problems are detected and displayed by your EtherScope.

RF and Traffic Statistics Overview

The Channel, BSSID, and Client Details screens can display RF and Traffic Statistics if any traffic is detected.

This section describes the common elements of the RF and Traffic Statistics screen. See the topic for each type of Details screen for differences.



The RF and Traffic Statistics card shows the Channel number or the Signal strength of the strongest AP on the channel and the channel's Utilization percentage.

Tap the card to view graphs of Signal, Noise, Utilization, and Retries.

To pan and zoom on the graphs, you can swipe, double tap, and move the slider. See the [Trending Graphs](#) topic for an overview of the graph controls.

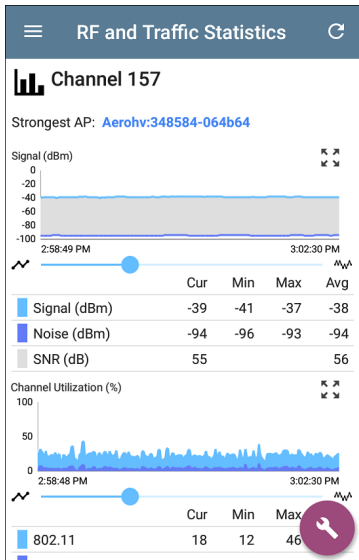

Strongest AP: The AP on the channel with the strongest signal

Under each graph, a legend table displays the Current, Minimum, Maximum, and Average

measurements. The Current column contains measurements from the last second. Min, Max, and Avg columns show cumulative measurements gathered during the time the RF and Traffic screen has been open.

Tap the refresh button  at the top of the screen to clear and restart the measurements.

Signal (dBm) graph: Plots the signal strength in dBm of the selected AP or AP with the strongest signal on a channel

- Signal - The AP's signal strength in dBm
- Noise - The noise level in dBm on the channel used
- SNR - The network's signal-to-noise ratio, a measure of signal strength relative to noise, measured in decibels (dB)

Channel Utilization (%) graph: Plots percentage of the channel capacity being used by 802.11 devices and by non-802.11 interference.

(EXG-200 only) If the **Combine Utilization** setting is enabled in [General Settings](#), the Utilization graph shows combined channel utilization and 802.11 utilization only for BSSIDs and Clients.

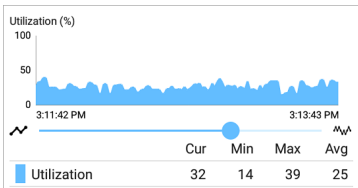

Retries (% of packets) graph: Plots percentage of transmitted packets that are retry packets.

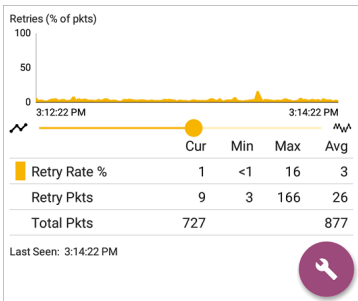



- **Retry Rate %** - The percentage of total packets that are retry packets
- **Retry Pkts** - The number of retry packets

- Total Pkts - The total number of transmitted packets

Locating Wi-Fi Devices

You can use your EtherScope to locate APs and Wi-Fi clients from the Channels Map screen for [BSSIDs](#) and [Clients](#).

To begin a location action:

1. Start the Wi-Fi app.
2. From the menu icon , select **BSSIDs** or **Clients**.
3. Select the BSSID or Client that you want to locate.
4. Tap the FAB menu icon  in the lower right corner of the screen. This displays the FAB pop-up options.

The screenshot displays the 'Wi-Fi - BSSID' screen. At the top, there is a blue header with a menu icon and the title 'Wi-Fi - BSSID'. Below this, a grey card contains the following information: a Wi-Fi icon, the BSSID 'ASUSTekC:d850e6-cc9c9c', the SSID 'wisornet-wpa2psk', the AP 'router.asus.com', the BSSID 'd850e6-cc9c9c', the channel '802.11', and the channel '48 (80 MHz, 36 - 48)'. It also lists 'Types: ac, n, a', 'Signal: -46 dBm', 'SNR: 43 dB', and 'Security Type: WPA2-P'. The 'Last Seen' time is '9:43:28 PM'. To the right of the card are two buttons: 'Locate' and 'Connect', each with a corresponding circular icon. Below the card are three more sections: 'Rates and Capabilities' with a 'Capture (Wi-Fi)' button and a circular icon; 'Clients' with a 'Name and Authorization' button and a circular icon; and 'RF and Traffic Statistics' with a circular icon containing an 'X'.

ASUSTekC:d850e6-cc9c9c
BSSID
SSID: wisornet-wpa2psk
AP: router.asus.com
BSSID: d850e6-cc9c9c
802.11
Channel: 48 (80 MHz, 36 - 48)
Types: ac, n, a
Signal: -46 dBm
SNR: 43 dB
Security Type: WPA2-P
Last Seen: 9:43:28 PM

Locate

Connect

↑↓ Rates and Capabilities Capture (Wi-Fi)

📶 Clients Name and Authorization

📊 RF and Traffic Statistics
CH: 48 (80 MHz, 36 - 48) Utilization: 0%

5. Tap **Locate**. This opens the Locate screen and causes your EtherScope to "listen" for the BSSID or Client wireless devices you

want to find using either the internal antennas or the optional external antenna (sold separately or in kits).



Locate BSSID

**ASUSTekC:d850e6-cc9c9c**

Channel: 48 (80 MHz, 36 - 48)

Signal: -45 dBm

Signal (dBm)

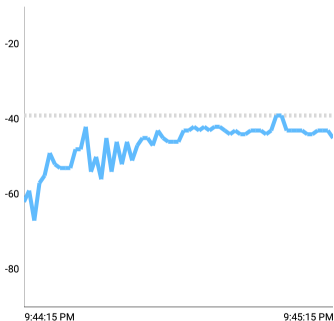



Last Seen: 9:45:15 PM



External Antenna



- Tap the speaker icon  to enable an audible tone that increases in pitch as the signal strength of the device increases (as you get closer to it).
 - Tap the speaker icon  to toggle sound on or off.
 - Use the volume buttons on the side of the unit to keys to control tone volume.
- Tap the **External Antenna** toggle to enable the optional external antenna for BSSID or Client location.
 - In areas with many rooms, like a hospital or school, the internal antennas are more effective. See [Using the Internal Antennas to Locate](#) below.
 - In large, open areas, the external antenna can help locate devices more quickly. See [Using the Optional External Antenna](#) below.

Locating with the Internal Antennas

EtherScope uses the internal antennas by default.

1. Navigate to the RF and Traffic Statistics screen for the BSSID (AP) or client you need to locate.
2. (Optional) Tap the speaker icon to toggle the audible tone on or off.

3. Divide the area you want to search into four sections.

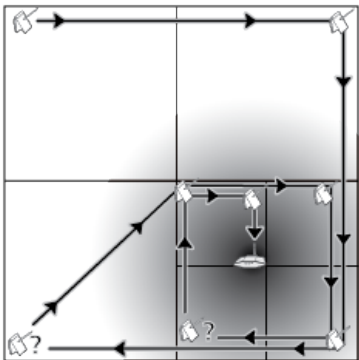

4. Go to one corner of your search area, and note the device's signal strength on the Signal graph.
5. Go to the other three corners of the area, and note the signal strength at each corner.
6. Go to the section with the strongest signal.

7. Repeat steps 3 through 6 until you find the device.

If you still cannot find the device, try looking on the floors above or below you. If you cannot find a client, try locating the AP to which the client is connected first.

Locating with the Directional External Antenna

In large, open areas, the directional external antenna can help determine the direction of a signal source more precisely than the internal antennas. Visit NetAlly.com for purchasing information.

1. If using the Directional Tri-band (2.4, 5, and 6 GHz) external antenna, screw the antenna's RP-SMA connector into the topXXX antenna port (shown below). If using the Dual-band (2.4 and 5 GHz) Flag antenna, screw the external antenna cord into the antenna port.

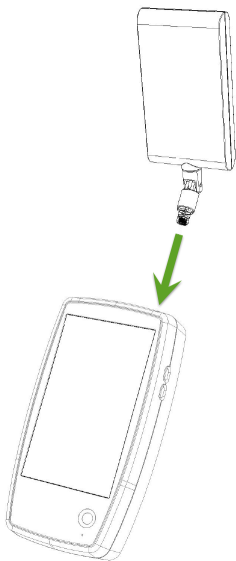

2. On the RF and Traffic Statistics screen, tap the **External Antenna** toggle to enable the external antenna.

- (Optional) Tap the speaker icon to toggle the audible tone on or off.
- Divide the area you want to search into four sections.

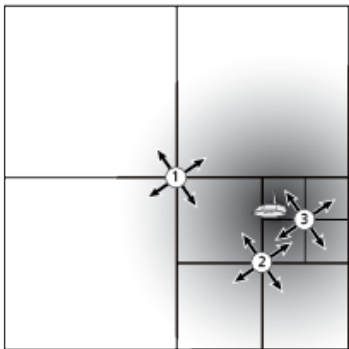

- Go to the center of your search area.
- For the Directional Tri-band external antenna, use the swivel joint on the RP-SMA connector to angle the antenna so that the "target" silkscreen on the antenna points toward your search area, as shown below.

Point the antenna towards each corner of the area. To get the best measurements, hold it at a constant height and above barriers such as cubicle walls.

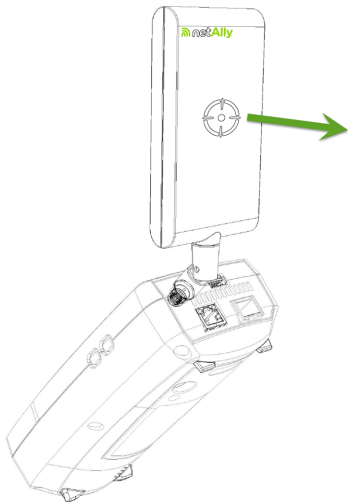

7. For the Dual-band Flag antenna, point the front edge of the antenna toward your search area, as shown below.



8. Go to the middle of the section with the strongest signal.
9. Repeat steps 4 through 7 until you find the device.

Channels Map

The Channels Map screens provide charts of channel utilization with AP coverage and overlap. Swipe right or left or tap the tab names to switch between the chart types: **Map**, **Map 6E**, or **Overlap**.



Map and Map 6E Tabs

The Map and Map 6E tabs display a bar graph of 802.11 and non-802.11 utilization, retry percentage, APs for each channel, clients for each channel, and illegal channels. (The Map 6E tab is for 6 GHz channels only.)

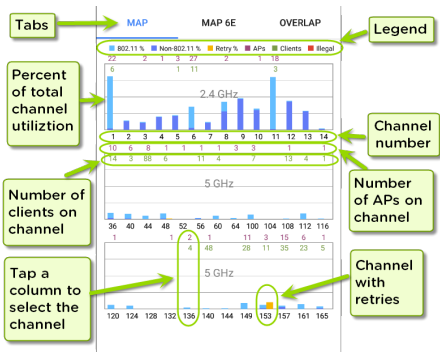

- Blue vertical bars show the percentage of each channel's capacity used by 802.11 devices (light blue) and non-802.11 interference (dark blue). (EXG-200 only) If the

Combine Utilization setting is enabled in [General Settings](#), the graph shows only combined 802.11 and non-802.11 Utilization.

- Yellow bars next to the blue bars show the percentage of retries.
- Channel numbers are listed on the x-axis and utilization percentage on the y-axis.
- AP counts for the APs' primary channel are shown in dark red at the top of the column for each channel. In the example below, Channel 161 has 7 APs. (Channels without APs can still show 802.11 utilization because of overlap from adjacent channels.)
- Client counts for the channel are shown near the top of the column for each channel. In the example below, Channel 161 has 15 clients.
- Tap a Channel's column on the Map or Map 6E graph to select and highlight the channel. This displays the CHANNEL DETAILS and SPECTRUM links at the bottom of the screen. In the example below, Channel 161 is

highlighted.

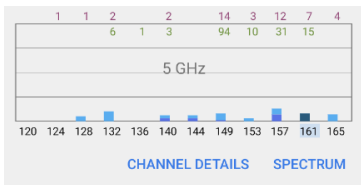

The [Channel Details](#) screen lets you examine the addresses and devices operating on the channel and perform a deeper analysis.

The [Spectrum](#) link opens the Spectrum app, a Wi-Fi spectrum analyzer that provides data about signal strength and noise.

Overlap Tab

Tap **Overlap** to view access point channel, coverage, and overlap. This can help you spot potential coverage issues. Each discovered AP is shown as a colored bracket on a graph based on channel coverage (on the x-axis) and signal strength in dBm (on the y-axis).

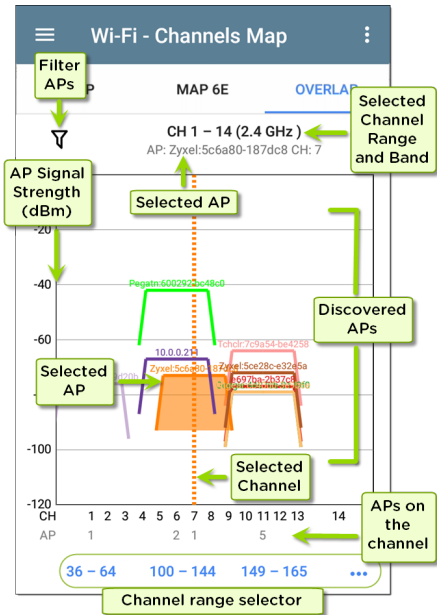

- Tap the Filter icon  near the top left to open the Overlap Filters screen to control

what APs are displayed. You can select filters for channels, SSIDs, Signal, SNR, 802.11 type, or Security.

- Tap an AP on the graph to select it and its primary channel. This highlights the area covered by the channel and lists the channel information above the graph. In the image below, the AP named "Technico:54a65c-a2b35b" on channel 1 is selected.

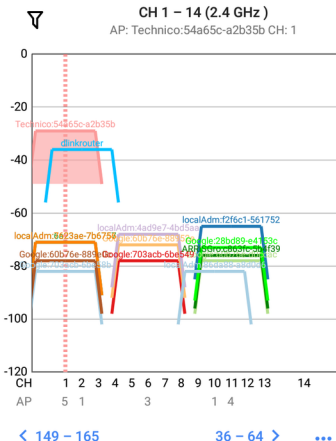

- Double-tap the graph to zoom in or use "pinch" gestures with your thumb and forefinger. Tap the Restore icon (🔄) or reverse the pinch gesture to return to the full graph. The image below shows a zoomed-in view with the AP named "Technico:54a65c-a2b35b" on channel 1 selected.

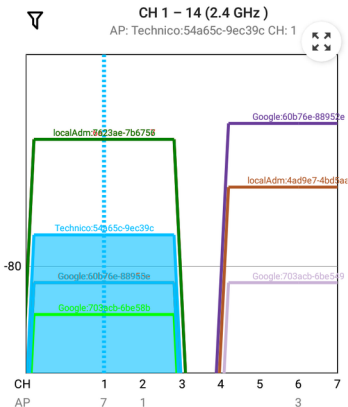



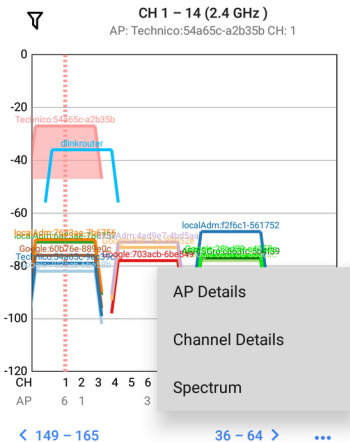







- Tap the **blue channel** selectors at the bottom to view a different Wi-Fi band (2.4, 5 and 6 GHz) and channel range on the graph.
- Tap the action overflow button **...** to open the **AP Details** or **Channel Details** screens for the selected AP or Channel or to open the **Spectrum Test App**.





See [Filtering in the Wi-Fi App](#) for an explanation of the Overlap screen's filtering options.

Channels

The Channels list screen displays the characteristics of the wireless Channels as they are scanned in your location.

Wi-Fi - Channels (43)			
		Channel	
	Channel 1	APs: 11	>
Channel 1	2.412 GHz	Util: 32 %	
	Channel 2	APs: 0	>
Channel 2	2.417 GHz	Util: 20 %	
	Channel 3	APs: 0	>
Channel 3	2.422 GHz	Util: 0 %	
	Channel 4	APs: 0	>
Channel 4	2.427 GHz	Util: 7 %	
	Channel 5	APs: 1	>
Channel 5	2.432 GHz	Util: 37 %	
	Channel 6	APs: 11	>
Channel 6	2.437 GHz	Util: 53 %	
	Channel 7	APs: 0	>
Channel 7	2.442 GHz	Util: 24 %	

You can [Filter](#)  and [Sort](#)  the list to determine which Channels are shown and their order. Refer to the [Wi-Fi App List Screens](#) topic if needed.

By default, Channels are ordered by channel number, and each card shows the channel frequency, number of APs, and total Utilization percent.

Tap a Channel card to open the Channel Details screen.

Channel Details

 **Wi-Fi - Channel**

 **Channel 1**
2.412 GHz
Channel: 1
Center Frequency: 2.412 GHz
Frequency Range: 2.402 - 2.422 GHz
Width: 20 MHz
Band: 2.4 GHz

 **Problems** 1 >
Warnings: 1

 **SSIDs** 24 >
[Hidden], Battle Mountain Crestron, CiscoE42...

 **APs** 17 >
10.250.2.101, 10.250.3.9, Cisco-Li:20aa4b-0f...

 **BSSIDs** 46 >
18b169-8e7456, 18b169-8e7457, 18b169-c7...

 **Clients**



The Channel Details screen displays the channel's Center Frequency under the icon,

along with the Frequency Range, Width, and Band.

Dynamic Frequency Selection (DFS) channels also display an Attributes field that indicates DFS.

Channel RF and Traffic Statistics

The RF and Traffic Statistics card appears when there is an active AP and Utilization on the channel. See [RF and Traffic Statistics Overview](#) in the Wi-Fi Details Screens topic.

Channel FAB

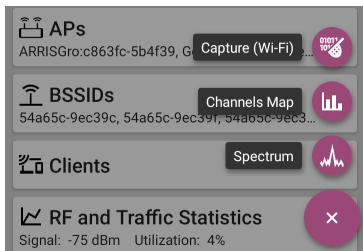















Tap the [FAB](#) on the Channel Details screen to:

- Open the [Capture](#) app to record a packet capture on the channel.
- Open the [Channels Map](#) screen with the current channel selected.
- Open the [Spectrum](#) app to view signal measurements for the channel.

SSIDs



The SSIDs list screen shows all the network SSIDs the EtherScope has discovered.

Wi-Fi - SSIDs (89)		
Filter	Sort	Signal
 Cisco WEP64 OA		-61 dBm > APs: 1
-61 dBm		
 HNTNetgear2.4G		-61 dBm > APs: 1
-61 dBm		
 Cisco 5G		-62 dBm > APs: 2
-62 dBm		
 CiscoQATest-mañana		-62 dBm > APs: 1
-62 dBm		
 Cisco WEP128 OA		-62 dBm > APs: 1
-62 dBm		
 Cisco WEP128 SA		-62 dBm > APs: 1
-62 dBm		
 Home-Guest-2.4G		-62 dBm > APs: 1
-62 dBm		

You can **Filter**  and **Sort**  the list to determine which SSIDs are shown and their order. Refer to the [Wi-Fi App List Screens](#) topic if needed.

By default, SSIDs are ordered by Signal strength. Each card shows the network security status and number of APs on the network.

The security status icons have the following meanings:

-  Green closed lock: All APs on the network use secure protocols, like WPA2 or WPA3.
-  Yellow closed lock: One or more APs use WEP or Cisco LEAP protocols, which are less secure.
-  Red open lock: The network does not have security enabled.

Tap a SSID card to open the SSID Details screen.

SSID Details

 **Wi-Fi - SSID**

 **LRG**
Broadcast SSID
SSID: LRG
Types: ac, n, g, a, b
Security Type: WPA2-P
Strongest AP: [Sonicwal:18b169-c84602](#)
Signal: -35 dBm
Last Seen: 3:10:00 PM

 **APs** 13 >
Sonicwal:18b169-8e7456, Sonicwal:18b169-...

 **BSSIDs** 22 >
18b169-8e744f, 18b169-8e7457, 18b169-c7f...

 **Channels** 9 >
1, 6, 11, 36, 40, 44, 149, 157, 161

 **Clients** 19 >



In addition to the Signal and Security Type, the SSID Details displays the AP on the network with the strongest signal, 802.11 Types that the APs in

the network support, and the time the EtherScope last detected activity on the network (Last Seen).

EtherScope nXG can detect and display 802.11 types a/b/g/n/ac/ax.

SSID FAB

Tap the **FAB** on the SSID Details screen to **Connect** to the network.

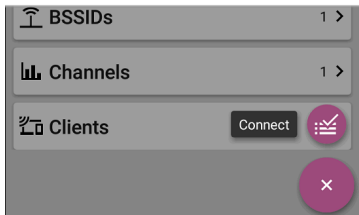



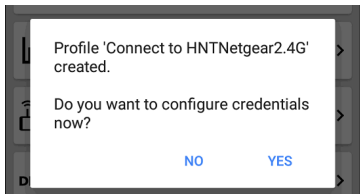



This action opens the **AutoTest** app and creates a new **Wi-Fi profile** called "Connect to [SSID]."





See [Creating a Wi-Fi Profile from the Wi-Fi Analysis App](#) in the AutoTest chapter for a more detailed description of this process.

APs

The APs list screen displays all the Access Points discovered operating on your wireless networks.

Wi-Fi - APs (54)		
Filter	Sort	Signal
	Ntgear:3c3786-719307	-26 dBm > Ntgear
	3e3786-719300	-29 dBm > --
	Lnksys:c8b373-05ac3c	-39 dBm > Lnksys
	Aerohv:348584-064b64	-40 dBm > Aerohv
	J125:002091-554431	-46 dBm > J125
	Lnksys:c8d719-a51bcb	-48 dBm > Lnksys
	Cisco3702 Kris A	-50 dBm

You can **Filter**  and **Sort**  the list to determine which APs are shown and their order.

Refer to the [Wi-Fi App List Screens](#) topic if needed.

By default, APs are ordered by Signal strength, and each card shows the Signal strength in dBm and the AP's manufacturer prefix.

Tap an individual AP's card to open the AP Details screen.

AP Details

☰ Wi-Fi - AP

 **Ntgear:3c3786-719307**

AP

AP: [Ntgear:3c3786-719307](#)

Mfg Prefix: Ntgear

802.11

Types: ax, ac, n, g, a, b

Security Type: WPA2-P

Signal: -28 dBm

Last Seen: 4:09:05 PM

 **Problems** 2 >

Warnings: 2

 **SSIDs** 2 >

Nighthawk 802.11 ax 2.4GHz, Nighthawk 802.1...

 **BSSIDs** 2 >

3c3786-719306, 3c3786-719307

 **Channels** 2 >

6, 36 (80 MHz, 36 - 48)

The AP Details screen shows the 802.11 Types the AP supports, the AP's Security Type, and the







time the AP was last detected (Last Seen) by the EtherScope.



Tap the lower cards to view the network IDs, Channels, and Clients associated with the AP.

See [Wi-Fi Problems](#) for more information about the Problems card.

BSSIDs

The BSSIDs list screen shows the BSSID addresses discovered in your wireless environment.

Wi-Fi - BSSIDs (121)		
Signal		
 3e3786-719300 -27 dBm	Nighthawk-Guest ...	-27 dBm CH: 6
 Ntgear:3c3786-719307 -28 dBm	Nighthawk 802.1...	-28 dBm CH: 6
 Ntgear:3c3786-719306 -37 dBm	Nighthawk 802.1...	-37 dBm CH: 36
 Aerohv:348584-064b64 -39 dBm	HNT 802.11ax	-39 dBm CH: 157
 Lnksys:c8b373-05ac3b -42 dBm	The Office Netwo...	-42 dBm CH: 1
 Lnksys:c8d719-a51bcb -48 dBm	Linksys15538	-48 dBm CH: 1
 1125-002091-554431 -49 dBm		-49 dBm

You can [Filter](#)  and [Sort](#)  the list to determine which BSSIDs are shown and their order. Refer to the [Wi-Fi App List Screens](#) topic if needed.

By default, BSSIDs are ordered by signal strength, and each card shows the signal strength, SSID, and channel number on which the BSSID operates. The icons indicate different types of BSSID:



Single, transmitted



Reduced neighbor report, transmitted



Reduced neighbor report, non-transmitted



Multiple, transmitted (6 GHz)





Multiple, non-transmitted (6 GHz)

Colors show the BSSID's status: black indicates normal status, **yellow** indicates a warning-level problem, and **red** indicates an error-level problem.

Tap a BSSID's card to open the Details screen.

BSSID Details

 **Wi-Fi - BSSID**

 **localAdm:cad676-e0adc0**
Reduced Neighbor Report (Transmitted)
SSID: **QA-Meraki-WPA3-E**
AP: **localAdm:cad676-e0adc0**
BSSID: cad676-e0adc0
802.11
Channel: **52 (40 MHz, 52 - 56)**
Types: ax, ac, n, a
Signal: -36 dBm
SNR: 58 dB
Tx Power: 22 dBm
Security Types: WPA3-E, FT-WPA2-E
QBSS Station Count: 1
QBSS Channel Utilization: 3%
Amendments: k, v
Last Seen: 4:30:28 PM

 **RNR BSSIDs** 3 >

 **↑↓ Rates and Capabilities**

In addition to the characteristics on the BSSID cards, the Details screen displays the following information:

- User-assigned [Authorization status](#) (if set)
- Supported **802.11 Types**
- Signal-to-Noise ratio (**SNR**) measurement
- Network **Security** type (802.11 Amendment r is indicated by an **FT-** prefix.
- QBSS station count and channel utilization
- Active 802.11 Amendments (k or v)
- Time activity was **Last Seen** on the BSSID

BSSID Details also includes cards that link to Rates and Capabilities details, the Wi-Fi [Clients](#) list, and [BSSID RF and Traffic Statistics](#) details.

Rates and Capabilities

Tap the Rates and Capabilities card to open the full screen.



Rates and Capabilities



localAdm:cad676-e0adc0

Reduced Neighbor Report (Transmitted)

Rates (Mbps)

Supported: 12, 18, 24, 36, 48, 54

Basic: 12, 24

Country Code: US

802.11 Capabilities

BSS Transition (v): true

Radio Resource Measurement (k): true

802.11n Capabilities

SGI 20 MHz: true

SGI 40 MHz: true

Max AMPDU: 65535 bytes

	Tx	Rx
Max Rate	600.0 Mbps	600.0 Mbps
Max Streams	4	4
Max MCS	31	31

802.11ac Capabilities

SGI 80 MHz: true

SGI 160 MHz: false

Max AMPDU: 1048575 bytes

MU Beamformer: true

This screen shows advanced information about the transmit and receive rates and 802.11 capabilities reported by the beacon.

Rates (Mbps)

Supported: The extended physical (PHY) rates that the AP is configured to support

Basic: The basic physical (PHY) rates that the AP is configured to support

Country Code

The 802.11d country code as detected for the country in which you use your device.

802.11 Capabilities

- BSS Transition amendment (v) status is shown.
- vRadio Resource Measurement amendment status is shown.
- 802.11n capabilities are gathered from HT capabilities in the beacon.
- 802.11ac capabilities are gathered from VHT capabilities in the beacon.
- 802.11ax capabilities are gathered from HE capabilities in the beacon.

802.11ax Rates and Capabilities

EtherScope nXG can also report Advanced 802.11ax (Wi-Fi 6) capabilities detected in the beacon.

Rates and Capabilities		
802.11ax Capabilities		
Max AMPDU: 4194303 bytes		
SU Beamformer: true		
SU Beamformee: true		
MU Beamformer: false		
	Tx	Rx
Max Rate	573 Mbps	573 Mbps
Max Streams	4	4
Max MCS	11	11
Advanced 802.11ax Capabilities		
+HTC HE Support: true		
TWT Requester Support: false		
TWT Responder Support: false		
Fragmentation Support: 1		
Maximum Number Of Fragmented MSDUs/A-MSDUs Exponent: 0		
Minimum Fragment Size: None		
HE Link Adaptation Support: 0		
All ACK Support: false		
BSR Support: false		
Broadcast TWT Support: false		
32-bit BA Bitmap Support: false		
MU Cascading Support: false		
Ack-Enabled Aggregation Support: false		
DM Control Support: false		

Interworking

EtherScope nXG can also report Interworking information (also known as Passpoint and Hotspot 2.0) detected in the beacon.

☰ Rates and Capabilities

Max Rate	216.7 Mbps	216.7 Mbps
Max Streams	3	3
Max MCS	23	23

802.11ac Capabilities

SIGI 80 MHz: true
 SIGI 160 MHz: false
 Max AMPDU: 1048575 bytes
 MU Beamformer: false

	Tx	Rx
Max Rate	288.9 Mbps	288.9 Mbps
Max Streams	3	3
Max MCS	9	9

Interworking

Access Network Type: Chargeable public (2)
 Internet: true
 ASRA: false
 ESR: false
 UESA: false
 Venue Group: 0
 Venue Type: 0
 ANQP OI Count: 0
 Roaming OIs: Google (f4f5e8)
 Hotspot 2.0 Version: 2
 DGAF Disabled: true

Clients

Tap the **Clients** card to open the Wi-Fi Clients list screen.

BSSID RF and Traffic Statistics

Tap the **RF and Traffic Statistics** card to open the RF and Traffic Statistics screen. This screen displays the BSSID and channel number at the top of the screen as well as informational graphs.

To pan and zoom on the graphs, you can swipe, double tap, and move the slider under each graph. Tap the Restore icon  to return to the full graph. (See the [Trending Graphs](#) topic for an overview of the graph controls.)

See [RF and Traffic Statistics Overview](#) in the Wi-Fi Details Screens topic for an explanation of the common elements of this screen.

The Signal graph shows the signal in light blue, noise in dark blue, and a calculated SNR.

The Channel Utilization graph uses light blue to show 802.11 channel utilization and dark blue to show non-802.11 utilization:



RF and Traffic Statistics



D-LinkIn:802689-4cc98a

Channel: 153 (80 MHz, 149 - 161)

Signal (dBm)



	Cur	Min	Max	Avg
Signal (dBm)	-43	-44	-37	-38
Noise (dBm)	-95	-95	-92	-94
SNR (dB)	52			55

Channel Utilization (%)

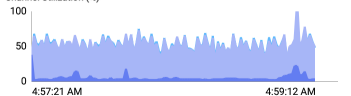

	Cur	Min	Max	Avg
CH 802.11	48	24	100	53
BSSID 802.11	46	<1	94	48

The screen also displays separate graphs for BSSID Retries and Channel Retries:

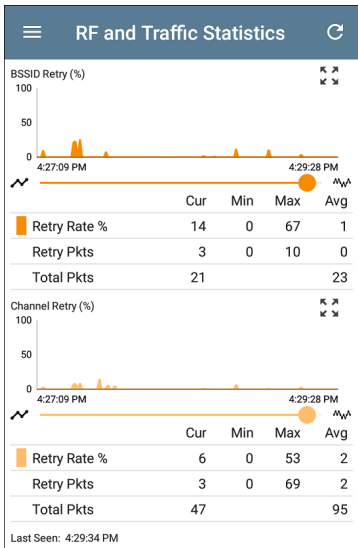

BSSID FAB

The floating action button on the BSSID screen lets you **Locate** the wireless device, **Connect** to the BSSID, record a packet **Capture** of the

network traffic with the current BSSID on the connected channel, and assign or change its **Name and Authorization**.

☰ Wi-Fi - BSSID



ASUSTekC:d850e6-cc9c9c

BSSID

SSID: [wisornet-wpa2psk](#)

AP: [router.asus.com](#)

BSSID: d850e6-cc9c9c

802.11

Channel: **48 (80 MHz, 36 - 48)**

Types: ac, n, a

Signal: -46 dBm



SNR: 43 dB

Security Type: WPA2-P

Last Seen: 9:43:28 PM

Locate

Connect

↕

Rates and Capabilities

Capture (Wi-Fi)



👤

Clients

Name and Authorization



📊

RF and Traffic Statistics

CH: 48 (80 MHz, 36 - 48) Utilization: 0%





- Selecting **Locate** opens the Locate BSSID screen. See [Locating Wi-Fi Devices](#).
- Tapping **Connect** opens the [AutoTest](#) app and creates a new [Wi-Fi profile](#) called "Connect to [BSSID]." See [Creating a Wi-Fi Profile from the Wi-Fi Analysis App](#) in the AutoTest chapter for a more detailed description of this process.
- Selecting **Capture** opens the Capture app populated with the Channel and BSSID. See the [Capture app](#) chapter.
- Selecting **Name and Authorization** opens the Name and Authorization dialog. See [Assigning a Name and Authorization to a Device](#).



Clients

The Clients list screen displays the wireless clients the EtherScope has discovered connected to your wireless networks.

Wi-Fi - Clients (61)		
Filter	Sort	Signal
 192.168.0.105	-34 dBm	>
-34 dBm	LiftingRound	CH: 153
 ARRISGro:189c27-59da36	-50 dBm	>
-50 dBm	RuleGViolation	CH: 157
 Sonos:48a6b8-a730a3	-62 dBm	>
-62 dBm	--	CH: 6
 Sonos:48a6b8-a730a3	-62 dBm	>
-62 dBm	--	CH: 6
 localAdmin:6632b1-3eb...	-68 dBm	>
-68 dBm	--	CH: 153
 fe80::f28a:76ff:fe6c:82d0	-70 dBm	>
-70 dBm	Fragblast	CH: 8
 Sonos:48a6b8-a72f15	-71 dBm	>

You can [Filter](#)  and [Sort](#)  the list to determine which Clients are shown and their order. Refer to the [Wi-Fi App List Screens](#) topic if needed.

By default, the Clients are ordered by Signal strength, and each card shows the client's Signal strength in dBm, the SSID of the network to which the client is connected, and the channel number on which the Client is operating.

The general Client icons indicate whether the device is Probing  or Connected  to a network and able to receive data. If a Client is probing, two dashes -- display where the SSID would appear.

The Clients screen also shows specific icons for NetAlly testers, like the EtherScope icon  shown in the image above.

Tap a Client's card to open the Details screen.

Client Details

 **Wi-Fi - Client**

 **10.24.8.111**
Wi-Fi Client

Address
IP: 10.24.8.111
MAC: [localAdm:d65834-911230](#)

802.11
Channel: [157 \(40 MHz, 157 - 161\)](#)
Types: ac, n, a
Signal: -47 dBm
SNR: 42 dB

AP: [10.24.8.36](#)

SSID: [LRG](#)

BSSID: [Sonicwal:18b169-c8decf](#)
Security Type: WPA2-P

Last Seen: 9:29:39 PM

 **RF and Traffic Statistics**
Channel Utilization: 7% 

The top Client Details card for a connected Client displays the following information:

- Client's **IP** and **MAC** addresses.
- User-assigned **Authorization status** (if set)
- Supported **802.11** media **Types**
- Signal-to-Noise ratio (**SNR**) measurement
- Name of the **AP** to which the Client is connected
- **SSID** of the network to which the Client is connected
- **BSSID** on which the Client is operating
- Network **Security** type
- Time the Client was **Last Seen** by the Ether-Scope

Probing Clients

If the client is a Wi-Fi probing client, the details screen replaces AP details with a list of the SSIDs for which the client is probing in the **Probes For** field:

 UGSI:6c0b84-c1f09f

Wi-Fi Probing Client

AddressMAC: [UGSI:6c0b84-c1f09f](#)

802.11

Channel: 6

Types: g, b

Signal: -45 dBm

SNR: 50 dB

Last Seen: 11:03:02 AM

Probes For: _OpenWrt_5G, Nighthawk 802.11ax
5GHz, NETGEAR17-5G

Client RF and Traffic Statistics

Tap the **RF and Traffic Statistics** card to open the RF and Traffic Statistics screen. This screen displays the client's ID or address and channel number at the top of the screen as well as informational graphs.

To pan and zoom on the graphs, you can swipe, double tap, and move the slider under each graph. Tap the Restore icon  to return to the full graph. (See the [Trending Graphs](#) topic for an overview of the graph controls.)

See [RF and Traffic Statistics Overview](#) in the Wi-Fi Details Screens topic for an explanation of the common elements of this screen.

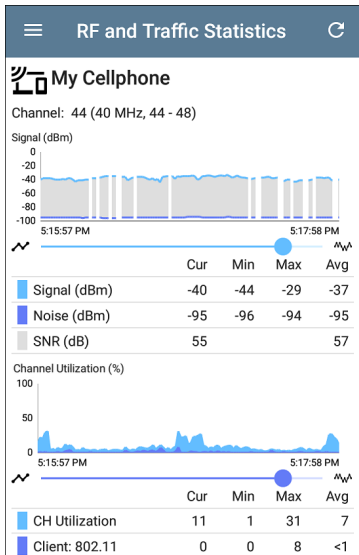

The Signal graph shows the signal in light blue, noise in dark blue, and a calculated SNR.

The Channel Utilization graph uses light blue to show 802.11 channel utilization and dark blue to show non-802.11 utilization:

Breaks in the Client RF and Traffic graphs may occur if the Client is not consistently transmitting, so there is no data for EtherScope to display during those times.

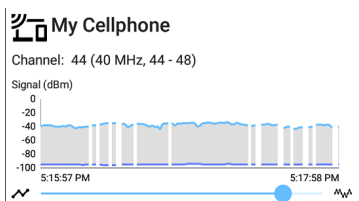

The Clients RF and Traffic Statistics screen also displays a graph of Transmit (Tx) and Receive (Rx) Rates in Mbps, number of Tx Streams, and Tx Channel Width in MHz.

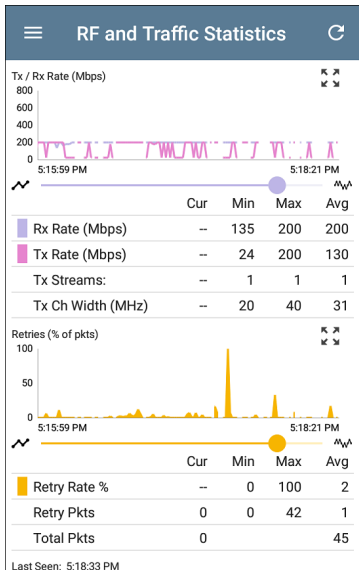

Clients FAB

Tap the **FAB** on the Client Details screen to **Locate** the client device, to open the **Capture** app to record a packet capture of traffic going to

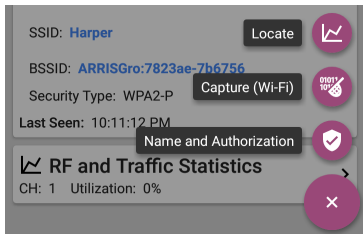

and from the client, or to assign or change its **Name and Authorization**.









- Select **Locate** to open the Locate Client screen. See [Locating Wi-Fi Devices](#).
- Select **Capture** to open the Capture app populated with the Channel and MAC address of the client. See the [Capture app](#) chapter.
- Select **Name and Authorization** to open the Name and Authorization dialog. See [Assigning a Name and Authorization to a Device](#).

Bluetooth

The Bluetooth list screen displays all the Bluetooth devices discovered operating on your wireless networks.

NOTE: This list requires that Bluetooth is enabled in your EtherScope nXG system settings. To verify, swipe down from the Status Bar at very top of the screen to open the system Notification Panel to see if the Bluetooth disabled icon  is displayed. If so, tap the icon to turn on Bluetooth and display the Bluetooth enabled icon .

Bluetooth (8)		Refresh	More
Sort	Signal		
 05F446-211985	-71 dBm	>	Microsoft
 007C2D-C82BDC	-73 dBm	>	Samsung Electronics Co. Ltd.
 032CDE-4E99ED	-76 dBm	>	Apple, Inc.
 40F6CD-B08D5B	-76 dBm	>	Google
 68644B-0905B8	-78 dBm	>	Apple, Inc.

You can [Sort](#)  the list to determine the order in which Bluetooth devices are shown. See [Sorting in the Wi-Fi App](#) for more details.

By default, Bluetooth devices are ordered by Signal strength. Each card shows the device address, signal strength in dBm (top right), and company name (bottom right).

NOTE: Your EtherScope nXG considers a device *inactive* if it is not seen in over 1

minute. These devices are displayed with a grey title text and signal strength value and grey title text on the [Wi-Fi - Bluetooth Device details screen](#). If the device continues to be inactive, EtherScope nXG considers the device *obsolete* and removes it removed from the list.

Tap an individual Bluetooth device card to open the Wi-Fi - Bluetooth Device screen.

Bluetooth Device Details



Wi-Fi - Bluetooth Device



BCA89B-86EAFB

Bluetooth Device

Name: S37cfefccafd5c1c0C

Address: BCA89B-86EAFB

RSSI: -66 dBm

Company

Name: Apple, Inc.

ID: 76

Beacon Type: iBeacon

UUID: 74278bda-b644-4520-8f0c-720eaf059935

Major ID: 0

Minor ID: 13343

Tx Power: -59 dBm

Advertisement

Flags: General Discoverable, Br Edr not Supported

Data: 0201061aff4c00021574278bdab64445208f0c
720eaf0599350000341fc50302221113095333
376366656666363616664356331633043

Last Seen: 5:24:51 PM









The Wi-Fi - Bluetooth Device screen shows the following:

- Address
- RSSI

- Manufacturer company name and ID
- Beacon type (Eddystone-UID, Eddystone-URL, iBeacon, or None), beacon-specific information (depending on the beacon type), and transmit power (if applicable)
- Any advertised flags or data
- Last seen date/time.

Interferers

(EXG-200 only) The Interferers screen displays devices detected by the EtherScope that may interfere with your networks.

Wi-Fi - Interferers (53)			
		Last Seen	
	Conv. Microwave	-72 dBm	>
	11:25:06 AM	2.4 GHz	Util: 5 %
	Possible Interferer	-36 dBm	>
	11:16:30 AM	2.4 GHz	Util: 69 %
	Inverter Microwave	-42 dBm	>
	11:17:26 AM	2.4 GHz	Util: 1 %
	RF Jammer	-71 dBm	>
	11:06:30 AM	2.4 GHz	Util: 100 %
	Possible Interferer	-72 dBm	>
	9:55:08 AM	2.4 GHz	Util: 76 %
	Bluetooth	-53 dBm	>
	9:36:44 AM	2.4 GHz	Util: 1 %

You can **Filter**  and **Sort**  the list to determine which Interferers are shown and their

order. Refer to the [Wi-Fi App List Screens](#) topic if needed.

By default, Interferers are ordered by the time they were most recently detected by the EtherScope. Each card shows the Last Seen time, the device's Power measurement in dBm, the frequency band on which it was detected, and its Utilization.

EtherScope can detect and display the following potential Interfering devices types:

- Baby Monitor
- Bluetooth
- DS Cordless Phone
- FH Cordless Phone
- Game Controller
- Possible Interferer
- Unknown Interferer
- RF Jammer
- YDI Narrowband Jammer
- Conventional Microwave
- Inverter Microwave

- Motion Detector
- Narrowband CW Signal
- Video camera

Tap an Interferer card to open the Details screen.

Interferer Details

 **Wi-Fi - Interferer**

 **Possible Interferer**

Possible Interferer

Power: -59 dBm

Utilization: 49 %

Affected Channels: 6
2.4 GHz: 3, 4, 5, 6, 7, 8

Duration: 10 seconds
First Seen: 11:34:56 AM
Last Seen: 11:35:06 AM

Event Count: 2

Power: The most recently observed power output from the device

Utilization: The percentage of time, during the most recent sample, for which the interferer was detected

Affected Channels: The bands and channels on which EtherScope detects the interfering device

Duration: Amount of time EtherScope detected the device and when it was first and last detected

Event Count: Number of separate instances of detected transmission from the interferer



Path Analysis App

Path Analysis traces the connection points, including intermediate routers and switches, between the EtherScope nXG and a destination URL or IP address. You can use Path Analysis to identify issues such as overloaded interfaces, overloaded device resources, and interface errors. It also shows how devices within your network (and off-net devices) are connected to each other along a path.

All switches are pre-discovered through SNMP queries. When the measurement is complete, EtherScope shows the number of hops to the destination device. A maximum of 30 hops can be reported.

Introduction to Path Analysis

Path Analysis combines Layer 3 and Layer 2 measurements.

The Layer 3 measurement combines the classic Layer 3 IP (UDP, ICMP, or TCP) traceroute measurement with a view of the path through the Layer 2 switches.

The Layer 2 measurement discovers switches between the router hops by looking for the routers' MAC addresses in the switch forwarding tables by sending SNMP queries to all discovered switches. The switches found in the path are displayed between the router hops when the measurement finishes.

Path Analysis is most effective when you have configured the Discovery app with SNMP credentials. See [SNMP Configuration](#) in the [Discovery Settings](#) topic to learn how.

Path Analysis Settings

The Path Analysis source device is always your EtherScope nXG. The default destination is www.google.com.

Populating Path Analysis from Another App

Like other EtherScope testing apps, when you open Path Analysis from another app, like [Discovery](#), the address of the network component you were viewing in the previous app is pre-populated as the Path Analysis Destination.

Configuring Path Analysis Manually

Open the app settings to configure a custom destination and select an Interface and Protocol. To open from the Path Analysis app screen, tap the settings  icon, or open the left-side [navigation drawer](#) and select **Path Analysis Settings**.

Path Analysis Settings	
Device Name	10.250.2.166
Interface	Any Port
Protocol	Connect (TCP)
TCP Port	80 (www-http)

On the Path Analysis Settings screen, tap each field as needed to configure your target:

Device Name: Tap to enter the IP address or DNS name of the Path destination. The default is `www.google.com`.

Interface: This setting determines the device port to run the path analysis runs. Tap the field to select a port. (See [Selecting Ports](#) for explanations of the different ports.)

EtherScope must have an active network link on the selected port to run a Path Analysis. If **Any**

Port is selected, available links are used in the order shown in the Interface selection dialog.

See [Test and Management Ports](#) for explanations of the different ports and how to link.

Protocol: Tap to select the Connect (TCP), Ping (ICMP), or Echo (UDP/7) protocol for your Path Analysis.

TCP Port: This field only appears if you have selected the Connect (TCP) Protocol. Tap to enter the port number over which you want to run Path Analysis. (You may need to enter a specific port number because routes can vary based on the port number and/or may be blocked by firewalls.)

Running Path Analysis

Tap the **START** button at the top of the app screen to begin a Path Analysis.

NOTE: EtherScope must be linked on the Interface (Port) selected in the app's settings. See [Test and Management Ports](#) for help.

The screenshot displays the Path Analysis App interface. At the top, there is a blue header bar with a hamburger menu icon on the left, the text "Path Analysis" in the center, and "START" and a gear icon on the right. Below the header, the main content is organized into several cards. The first card, titled "www.google.com", features a server rack icon, the URL "www.google.com", and latency measurements "10 ms, 6 ms, 11 ms". It lists "Device Name: www.google.com", "IP Address: 172.217.1.206", "Interface: Any Port", "Protocol: Connect (TCP)", and "TCP Port: 80 (www-http)". A "Results" section indicates the test "Started: 2:26:58 PM" and "Status: Destination reached in 11 hops". The second card, titled "ThisEtherScope", shows a mobile phone icon, the device name "ThisEtherScope", and a right-pointing chevron. It specifies "Out: Wired Port" and "1 Gb FDx". The third card, titled "Layer 2 Path", includes a keyboard icon and the text "No layer 2 devices discovered". The fourth card, titled "sr-cos-us-1.net.com", shows a server rack icon, the URL "sr-cos-us-1.net.com", latency measurements "13 ms, 12 ms, 3 ms", and "Hop: 1" with a right-pointing chevron. The fifth card, titled "10.232.142.22", shows a cloud icon and the IP address "10.232.142.22" with a right-pointing chevron.

☰ Path Analysis START ⚙️

 **www.google.com**
10 ms, 6 ms, 11 ms

Device Name: www.google.com

IP Address: 172.217.1.206
Interface: Any Port
Protocol: Connect (TCP)
TCP Port: 80 (www-http)

Results
Started: 2:26:58 PM
Status: Destination reached in 11 hops

 **ThisEtherScope** >

Out: Wired Port 1 Gb FDx

 **Layer 2 Path**

No layer 2 devices discovered

 **sr-cos-us-1.net.com** >
13 ms, 12 ms, 3 ms Hop: 1

 **10.232.142.22** >

Like AutoTest, Path Analysis results are presented on cards. The top card shows the main test details, the second card shows information for the source device (your EtherScope nXG), and the following cards show

the Layer 2 and Layer 3 Hops in the path, which are sequentially ordered.

Tap any [blue linked name or address](#) in the Path Analysis results screens to open the [Discovery](#) or [Wi-Fi](#) app and further examine the linked element.

Path Analysis Results and Source EtherScope Cards

 **google.com**
10 ms, 6 ms, 11 ms
Device Name: [google.com](#)
IP Address: 172.217.1.206
Interface: Any Port
Protocol: Connect (TCP)
TCP Port: 80 (www-http)
Results
Started: 2:26:58 PM
Status: Destination reached in 11 hops
[UPLOAD TO LINK-LIVE](#)

The top Path Analysis results card shows the path's Destination address at the top, followed by the three response times from the TCP Connect, Ping, or Echo tests.

Device Name: Resolved DNS name or IP address of the destination entered in the settings

IP Address: IPv4 address of the target destination

Interface: The Interface option selected in the settings

Protocol: The Protocol selected in the settings (TCP, Ping, or Echo)

TCP Port: The port number used for a TCP Connect Protocol. (This field does not appear for Ping or Echo Protocol results.)

Results

Started: Time at which the Path Analysis began

Status: Current status of the Path Analysis test, including any error messages

UPLOAD TO LINK-LIVE: Tap this link to upload your results to a Link-Live account. See [Uploading Results to Link-Live](#) later in this topic.

Source EtherScope Card

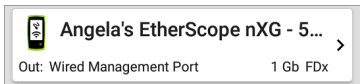

This EtherScope card displays the port from which the Path Analysis ran.

For Wired Test or Management port analyses (shown above), this card displays connection speed and duplex.

For Wi-Fi port analyses, the card displays the SSID and channel number.

NOTE: This card and screen only display a custom name for your EtherScope if you have [claimed it to Link-Live](#).

Tap the card to view more details. The example below shows the SSID, Channel, and other Wi-Fi information the EtherScope can display after running a Path Analysis over Wi-Fi.

☰
Path Analysis

ThisEtherScope

Device Name: [ThisEtherScope](#)

IP Address: 192.65.49.14

Out: Wi-Fi Port

SSID: [NSVisitor](#)

BSSID: [Cisco:0c2724-f8f0b3](#)

Channel: [52](#)

Protocol: 802.11n

Security: WPA2-P

Under the EtherScope source card, the Hop cards show Layer 2 and Layer 3 devices determined to be in the Path.

Layer 3 Hops

Each Layer 3 Hop card displays the device type icon, DNS name (if discovered), and IP address.



192.168.249.81

Hop: 2 >

8 ms, 4 ms, 3 ms

Beneath the name (or IP), the response times for each Connect (TCP), Ping (ICMP), or Echo (UDP/7) display in milliseconds. On the right side is the router Hop number of this device in the path.

Tap the card to view the hop Details screen.

 **Path Analysis**









 **192.168.249.81**
8 ms, 4 ms, 3 ms Hop: 2

Router: [192.168.249.81](#)

IP Address: 192.168.249.81

No Reply

Sometimes Path Analysis displays Hop cards with "No Reply" (as shown below). This result means that the device in that portion of the path did not send an ICMP TTL timeout response.

Path Analysis		START	⚙️
	No Reply -, -, -	Hop: 5	>
	4.34.62.118 23 ms, 22 ms, 18 ms	Hop: 6	>
	ae-6.pat1.nez.yahoo.com 47 ms, 40 ms, 46 ms	Hop: 7	>
	Split Route 41 ms, 25 ms, 34 ms	Hop: 8	>
	Split Route 38 ms, 45 ms, 31 ms	Hop: 9	>
	Split Route 48 ms, 28 ms, 47 ms	Hop: 10	>
	slb8-1-flk.ne1.yahoo.com 39 ms, 41 ms, 38 ms	Hop: 11	>
	www.yahoo.com 35 ms, 61 ms, 46 ms	Hop: 12	>

Split Route

Path Analyses may obtain a "Split Route" result (as shown above), meaning that two or three

different routers within same hop responded to the three requests.

Tap a Split Route card to view the DNS names and IP addresses of the responding routers.

☰
Path Analysis



Split Route

41 ms, 25 ms, 34 ms Hop: 8

Response 1: et-0-0-0.msr1.ne1.yahoo.com

IP Address: 216.115.105.25

Response 2: et-0-0-0.msr2.ne1.yahoo.com

IP Address: 216.115.105.179

Response 3: et-19-1-0.msr2.ne1.yahoo.com

IP Address: 216.115.105.181

Layer 3 Interfaces and Statistics

Statistics for Interfaces on Layer 3 devices may be identified and measured if the EtherScope has SNMP access.



COS_DEV_SW1

13 ms, 12 ms, 13 ms Hop: 3 >

In: Gi1/0/47

1 Gb FDx

Tap a Hop card to see a summary of Interface Details and Statistics, if they are available.

See also [Layer 2 Switch Interfaces and Statistics](#) below.

Network Problems in Path Analysis

The Hop cards can also show detected Problems based on the [Problem Settings](#) in the Discovery app and display the device type icons in the corresponding colors.

The yellow switch icon in the image above indicates a **Warning** status.

 **Path Analysis**

 **COS_DEV_SW1**
13 ms, 12 ms, 13 ms Hop: 3

Router: [COS_DEV_SW1](#)

IP Address: 192.168.249.82

 In: [Gi1/0/47](#)

Speed: 1 Gb
Duplex: FDx

Statistics
Util: 0.3 % Discards: 0.0 % Errors: 0.0 %

Tapping the [blue linked](#) switch name opens a [Discovery Details screen](#) for the switch, where the user can investigate the cause of the Warning.



Layer 2 Devices

Layer 2 devices can be switches or APs.

Layer 2 Switches

The image below displays an example of a Path Analysis to a device on the local broadcast domain with two switches in the Layer 2 portion of the path.

Path Analysis





Interface: Any Port
 Protocol: Connect (TCP)
 TCP Port: 80 (www-http)

Results

Started: 3:41:34 PM
 Status: Destination reached in 1 hop

[UPLOAD TO LINK-LIVE](#)

Angela's EtherScope nXG - 5...
>

Out: Wired Port 1 Gb FDx

COS_DEV_SW1
>

In: Gi1/0/13	VLAN: 500	1 Gb FDx
Out: Gi2/0/24	VLAN: 500	1 Gb FDx

cos-dev-sw18-poe
>

In: Gi0/1	VLAN: 500	1 Gb FDx
Out: Gi0/7	VLAN: 500	1 Gb FDx



Cetus
>

6 ms, 4 ms, 6 ms Hop: 1

The EtherScope is able to identify these Layer 2 switches and their interfaces because it has [configured SNMP](#) access to the switches.

The switch cards display the In and Out Interface IDs, VLAN ID, and the link speed and duplex (if detected) of the interfaces.

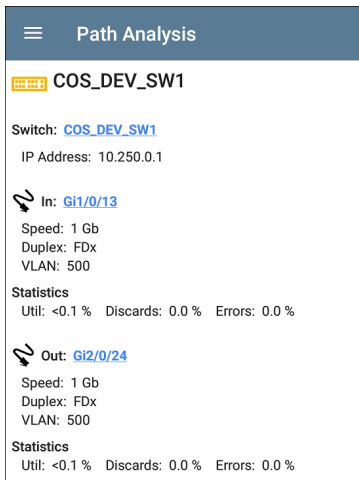
Tapping a Layer 2 card opens a Details screen for the device.



The screenshot shows the 'Path Analysis' app interface. At the top is a blue header with a hamburger menu icon and the text 'Path Analysis'. Below the header, the device name 'COS_DEV_SW1' is displayed with a keyboard icon to its left. Underneath, the switch name 'Switch: COS_DEV_SW1' and IP address 'IP Address: 10.250.0.1' are listed. The 'In' interface section features a plug icon, the interface name 'In: Gi1/0/13', and its properties: 'Speed: 1 Gb', 'Duplex: FDx', and 'VLAN: 500'. Below this is a 'Statistics' section showing 'Util: <0.1 %', 'Discards: 0.0 %', and 'Errors: 0.0 %'. The 'Out' interface section follows, with a plug icon, 'Out: Gi2/0/24', and the same properties: 'Speed: 1 Gb', 'Duplex: FDx', and 'VLAN: 500'. A final 'Statistics' section shows 'Util: <0.1 %', 'Discards: 0.0 %', and 'Errors: 0.0 %'.

A Layer 2 Details screen displays the device name and IP address at the top.

NOTE: The yellow switch icon in the image above indicates a **Warning** status. See [Network Problems in Path Analysis](#) later in this topic.

Layer 2 Switch Interfaces and Statistics

Layer 2 Switch Details screens in Path Analysis display a summary of the Interface Statistics (described below). To view all available information for these interfaces, tap their blue links to open a [Interface Details](#) screen in the Discovery app.

Statistics for Interfaces on Layer 2 switches may be identified and measured if the EtherScope has SNMP access.

In/Out: Indicates the interface type and name. The interface name often contains the physical port number where the switch is connected to the network.

Util: Percentage of total interface capacity being used

Discards: Percentage of total packets that have been dropped

Errors: Percentage of packets containing errors

Layer 2 APs

If the Layer 2 path starts or ends with a Wi-Fi device, its AP is shown as a Layer 2 device in the path.

A Layer 2 AP card indicates the connected network SSID, channel, and 802.11 type in use.

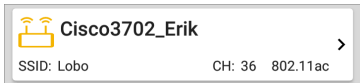

Layer 2 AP Details screens allow you to further examine the wireless characteristics by selecting their blue links, which open a [Wi-Fi app Details](#) screen.

 **Path Analysis**

 **Cisco3702_Erik**

AP: [Cisco3702_Erik](#)

IP Address: 10.250.3.69

 SSID: [Lobo](#)

BSSID: [Cisco:b83861-84aaf9](#)

Channel: [36](#)

Protocol: 802.11ac

Security: --

No layer 2 devices discovered

 **Layer 2 Path**

No layer 2 devices discovered

In some cases, the EtherScope does not discover Layer 2 devices between Layer 3 devices. There may not be any Layer 2 devices, or EtherScope might not have SNMP access to those switches.

The Layer 2 card may also display a result of "No switches found," which indicates that Discovery has not found any switches with SNMP access to

determine if the switches are in the path. If this is an unexpected result, check and verify your [SNMP Configuration](#) and [Extended Ranges](#) in the Discovery app settings.

Uploading Results to Link-Live

Tapping the **UPLOAD TO LINK-LIVE** link on the top card opens the [Link-Live](#) sharing screen for path analysis results:

**Link-Live**

by NetAlly



Path Analysis Name

20190419_131047

Comment

Conference Room B

Job Comment

Union Hall



SAVE TO ANALYSIS FILES

Path Analysis results are uploaded to the **Analysis** page  on Link-Live.

[Back to Title and Contents](#)



AirMapper™ App

The AirMapper Site Survey application enables you to perform a Wi-Fi survey of an indoor or outdoor location and upload it to Link-Live Cloud Service. On [Link-Live.com](https://link-live.com), you can view heatmaps and Wi-Fi measurements for each data collection point.

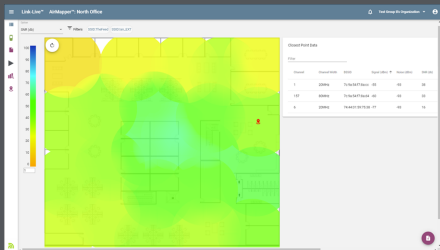



The Signal heatmap is available to all Link-Live users. **AllyCare** Support customers can also view maps of Noise, SNR, and Max TX and RX Rates. Visit [NetAlly.com/Support](https://netally.com/support).

AirMapper Settings

Setting up the AirMapper app to perform a survey involves naming the survey, loading a floor plan image, specifying its dimensions, setting scanning mode, and overriding bands and channels.

- Only .png and .jpg image files types are supported.
- You may need to use an image editing application to crop your floor plan image to known dimensions, such as the walls of a building or property boundary.

Access the AirMapper settings by selecting the menu icon  or settings icon  at the top of the main app screen.

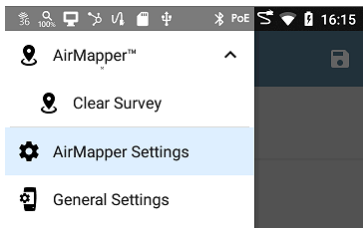

Configuring an AirMapper Survey

AirMapper Settings	
Name	Second floor survey
Description	Quick walk all isles
Floor Plan	Denver Site >
Survey Mode	Current Scan (Passive)
Override Bands and Channels	Disabled <input type="checkbox"/>

Name

Tap the **Name** field to enter a custom name for your AirMapper project. This name is uploaded to Link-Live to identify this survey project.

Description

Enter any additional information you want for the survey.

Floor Plan

NOTE: You can configure floor plans on Link-Live and then send them to your EtherScope nXG. A notification appears when a new floor plan arrives:

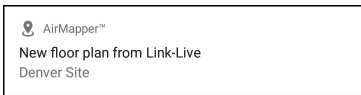

The new floor plan is added to the existing floor plans but is not automatically selected.

To select a floor plan:

1. Tap **Floor Plan** to open the list of available floor plans.

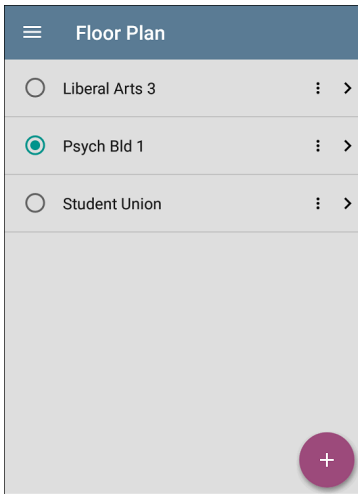

2. Select a floor plan or load a new floor plan by tapping the floating action button , using the file selector to navigate to the new map image file, and then tapping the file to select it. This displays the Floor Plan menu.



3. Fill out the remaining fields for the Floor Plan as needed:

Floor Plan	
Name	DenverSite
Imported File	DenverSite.png
Dimensions	500 x 711 feet >
Signal Propagation	20.0 feet

Name: Enter a name for this floor plan. This field defaults to the file name.

Imported File: The original image file name.

Dimensions: Tap this option to display the floor plan with two markers. Move the markers to two places on the floor plan that are a known distance apart. Then tap **Marker Distance** to enter the distance between the two points. (Set the units (feet or meters) in

the [General Settings](#) for the test apps, accessed from the left-side [navigation drawer](#) ) When finished, tap  to return to the Floor Plan menu.

Signal Propagation: Tap to enter a value for the propagation radius for the survey sample points.

Survey Mode

Tap Survey Mode to select the Wi-Fi data collection method that best suits your Wi-Fi environment and survey data collection requirements:

1. **Auto Sampling (Passive)** is the default and preferred way to perform a survey. AirMapper automatically records data (at the interval specified with the Auto Sampling Period setting) between two points that you choose. This simplifies data sampling and can prevent oversampling. For example, if your survey includes a long hallway or open space, you can take a manual sample measurement at one end of the area, go to the other end, and then take

another measurement. AirMapper fills in the line between the two measurements with automatic measurements made at the sampling period. See [Collecting AirMapper Data](#) for more information.

2. **Current Scan (Passive)** Passive surveys allow immediate data collection based on the most recent AP beacon seen from each BSSID. AP BSSIDs age out after 140 seconds, and Wi-Fi clients age-out after 4 minutes. For EXG-200 only: AP BSSIDs age out after 30 seconds.
3. **Scan Once (Passive)** is more precise but more time-consuming. When a point is selected, all the BSSID information is cleared, and the unit acquires a single scan of the selected channels for the selected dwell time. This gives an exact measurement. However, in congested environments any beacons not seen during the dwell time are not included in that sample point.

4. **Connected (Active)** collects data from the linked connection of the Wi-Fi Test port.
NOTE: Selecting this method disables the AirMapper settings for Dwell Time and Override Bands and Channels.

Auto Sampling Period

(Enabled for Auto Sampling mode only.) Tap to choose a preset sampling period or to enter a custom value. This setting controls how frequently an Auto Sampling survey takes automatic measurements between points that you select manually.

Dwell Time

(Enabled for passive survey modes only.) Tap to choose a preset dwell time or enter a custom value. See the [General Settings](#) for additional information about dwell time.

Override Bands and Channels

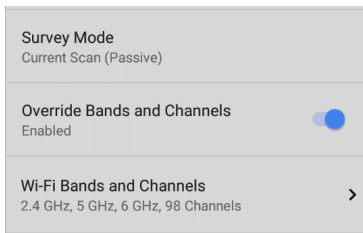

(Enabled for passive survey modes only.) Tap **Override Bands and Channels** to enable selection of different bands and channels than the values defined in [General Settings](#). (These override settings are used only for AirMapper site surveys.) Enabling this setting displays the [Wi-Fi Bands and Channels](#) setting.

Wi-Fi Bands and Channels

(Enabled only when [Override Bands and Channels](#) is enabled.) Tap **Wi-Fi Bands and Channels** to open a list of frequency bands. Then tap the frequency band to open a menu to select specific channels to use for that band. See the [General Settings](#) for additional information.

☰	Wi-Fi Bands and Channels
Wi-Fi Band(s)	2.4 GHz, 5 GHz, 6 GHz
2.4 GHz Channels	All
5 GHz Channels	All
6 GHz Channels	All

Note: Selecting a subset of channels and bands lets you exclude scans of unneeded channels from the survey. This improves survey performance and reduces the amount of data collected.

Changing Settings after Starting

You can reopen the AirMapper settings to change the **Floor Plan > Dimensions** or **Signal Propagation** size after starting your survey. Existing data points are retained on the map unless you select a different Floor Plan.

Note: NetAlly does *not* recommend that you change the band, channel, or dwell time settings after you have started a survey. The survey results for the multiple settings can create confusing or less reliable results. If you wish to do so and if the **Override Bands and Channels** setting is enabled, you can use the AirMapper Settings to make changes after you have started your survey. If the **Override Bands and Channels** setting is *not* enabled you must use the General Settings to make changes.

Hidden SSIDs and APs

For any [Hidden] APs or SSIDs at your site that you want detected during a survey, NetAlly recommends creating and enabling a Wi-Fi Profile in the AutoTest app, configured with the appropriate credentials. Otherwise, AirMapper detects the BSSIDs associated with hidden devices but may not determine their APs/SSIDs.

Collecting AirMapper Data

This section details how to collect and manage your survey data.

- [Conducting a Passive Survey](#)
- [Conducting a Connected \(Active\) Survey](#)
- [AirMapper Survey Tips](#)

Conducting a Passive Survey

The floor plan you have selected in [AirMapper Settings](#) displays on the main AirMapper screen.

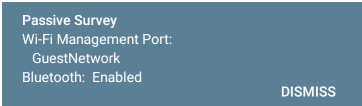

1. Tap **START** to begin the survey.
2. A message displays the survey type, radio, and Bluetooth status. This message appears each time you begin or restart or return to the survey from another app. Tap **Dismiss** to remove the message.

A screenshot of a dark blue rectangular message box with white text. The text is arranged in four lines: 'Passive Survey', 'Wi-Fi Management Port:', 'GuestNetwork', and 'Bluetooth: Enabled'. In the bottom right corner of the box, the word 'DISMISS' is written in white capital letters.

Passive Survey
Wi-Fi Management Port:
GuestNetwork
Bluetooth: Enabled

DISMISS

3. To collect data, move around your site, and tap the map at your current location to scan the enabled wireless channels in that spot. This displays a red circle on the floor plan.
 - Do not move from your location until the data point on the screen turns from red to green. (This takes only a few seconds and shows when the scan is complete.)

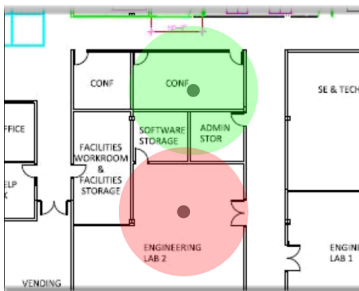

- You can undo the last point, rotate the image, and use swiping or pinch-to-zoom gestures to pan and zoom the map as needed.

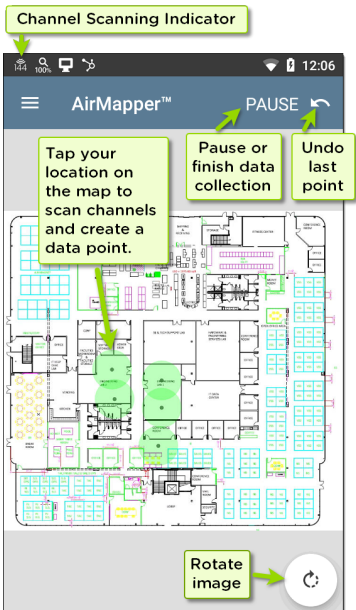

- If you use the default Auto Sampling (Passive) survey, you can collect data

points automatically, especially when sampling in straight lines such as long hallways or when crossing open spaces.

- a. Tap the floor plan to take a survey measurement, and wait for the circle to turn green.
- b. Move across the survey area, walking steadily in a straight line. Your unit emits a tone and increments a counter on the AirMapper screen header each time it reaches the value set in the Auto Sampling Period setting.

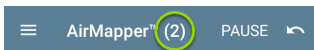



TIP: Tap the floor plan if you have to change directions or if you change your pace to walk either faster or slower.

- c. Tap floor plan again when you reach the end of the straight line. AirMapper automatically spaces

regular measurements along the path between the two locations you tapped, according to the Auto Sampling Period. These measurements are displayed in blue. (The second green circle may overlap differently depending on where you tap the floor plan a second time.)



- To check the Wi-Fi status, look at the icon  in the top status bar to see the channels that the EtherScope is scanning in real time.
4. To stop or pause your survey, tap **PAUSE**. This changes the Undo icon to the upload icon .
- If you want to upload your results to Link-Live, tap the upload icon , select **Upload to Link-Live** to display the Link-Live sharing screen. See [Uploading AirMapper Surveys to Link-Live](#) for more

information. (You can resume your survey after uploading.)

- Tap **RESUME** to add more data points.



- To start a new AirMapper survey, open the AirMapper Settings (tap the navigation menu icon  or swipe from the left-side drawer) and select **Clear Survey**.

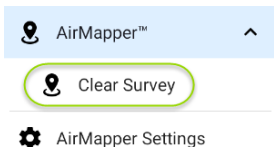

- To stop your survey, close AirMapper.

Conducting a Connected (Active) Survey

The steps for conducting a connected active survey have several key differences from those for a passive survey:

1. Before beginning the survey, use AutoTest to run a [Wi-Fi profile](#) that connects to the desired SSID.
2. Tap **START** to begin the survey. If you did not start the AutoTest profile or if the test is still in progress, a message displays at the bottom of the screen, and the survey cannot start.
3. Collect data as you would a passive survey, as described above.
 - If the connection is lost (such as by roaming out of range or a signal blockage), the link notification changes to an X. AutoTest continuously tries to reconnect to the SSID.

Survey points taken during this unlinked time are displayed in yellow to indicate

areas where there is not coverage for that SSID.

- You can check the Wi-Fi connection in several ways during your survey:
 - To check the Wi-Fi status, look at the icon  in the top status bar to see the channels that the EtherScope is scanning in real time.
 - Swipe down from the top of the screen to expand the system notification pull-down list and display the actively connected channels and channel width.

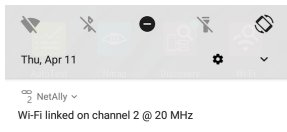

Tap the down arrow next to NetAlly to show additional information:

NetAlly ^

Wi-Fi linked on channel 2 @ 20 MHz

-34 dBm 72.2 Mbps Roams: 0

SSID: Fragblast

IP Address: 192.168.0.109

- If AutoTest was the recently used application other than AirMapper, you can double-tap the Recent button  at the bottom of the screen to quickly toggle between AirMapper and Autotest.
4. To stop or pause your survey, tap **PAUSE**, as described above for a passive survey.

AirMapper Survey Tips

Use these additional tips to make your survey process easier.

Changing Dwell Time During a Survey

NetAlly does not recommend that you change settings during a survey. An exception is **Dwell Time**, which sets the amount of time the EtherScope lingers on each channel to gather data. You can increase the Dwell Time value to

get averages of beacon signal. To change the Dwell Time setting:

1. Tap **Pause** to pause your survey.
2. Open the AirMapper settings, (tap the navigation menu icon  or swipe from the left-side drawer).
3. Tap **Dwell Time** to set a new value.
4. Return to the AirMapper screen and tap **Resume** to return to your survey.

Add Wi-Fi Management Port Data

For active or passive surveys, the active connection data is uploaded along with your other survey data if the Wi-Fi Management port is connected to an SSID. You can then view this information in its own heatmap displays on Link-Live.

Add and Edit Comments

- To edit a comment, long-press on the comment. (If two comments are very close together, AirMapper selects the comment closest to where you pressed.) A context

menu appears. Tap **Add Comment**. A dialog appears for you to type your comment. When you are done, tap **OK** to add the comment.

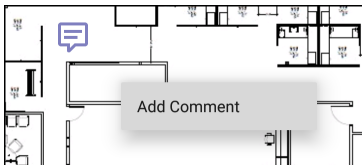

- To edit or delete a comment, locate the comment, and then long-press on it. The selected comment turns dark and a menu appears. Tap **Edit Comment** to change the comment, and then tap **OK** to save the edit. To delete the comment, select **Delete** from the menu.

To Delete Survey Points

Long press over the survey point you want to delete. The selected survey point turns red and a context menu appears. If two survey points overlap, the closest survey point is selected. Tap **Delete Survey Point**.

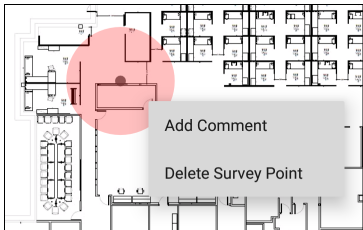



CAUTION: There is no undo for deleting a survey point. Once deleted, you cannot recover the data.

Upload AirMapper Surveys to Link-Live

Uploading your data to Link-Live lets you view colored heatmaps and use various analytical tools.

1. Tap the upload icon .
2. Select **Upload to Link-Live** from the pop-up menu to display the Link-Live sharing screen.

**Link-Live**
by NetAlly



Survey Name

North Office

Comment

Quick Coverage Test

Job Comment

Event Check



SAVE TO AIRMAPPER FILES

3. (Optional) Use the Link-Live sharing screen to enter a survey name, a comment for the overall survey, and a job comment (such as

a note about the overall job status).

NOTE: The Job Comment remains the same until you delete or change it.

4. Tap **SAVE TO AIRMAPPER FILES** to upload the data and return to the main AirMapper screen. You can then return to the AirMapper screen and tap **Resume** to return to your survey to add more data points, start another survey, or close AirMapper.

NOTE: When you upload data from a survey (or save it locally), your unit also uploads a Discovery analysis file to assist with data analysis on Link-Live. When you upload an active survey, the connection log is also uploaded.

To Export AirMapper Data to AirMagnet Survey PRO

When your survey data collection is complete, you can export the data as a .amp file for import into AirMagnet Survey PRO for advanced analysis, planning and reporting.

1. Tap the upload icon .
2. Tap **Export to Survey PRO** in the pop-up menu.

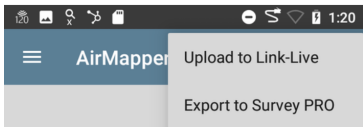

3. (Optional) Type a new name the .amp file.
4. (Optional) Tap one of the file folders displayed in the upper part of the screen to select a local file location.
5. Tap the **Save** button to create the .amp file and upload it to Link-Live (or to save the file locally).



6. Export the .amp file from Link-Live to download it to your PC for use with AirMagnet Survey PRO.

To Load and Save AirMapper Settings

You can save the entire survey configuration as named settings by tapping the disk icon in the title bar.



This allows to load saved settings or to save the current settings.

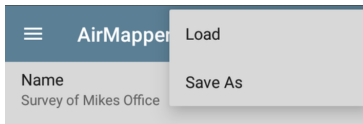



Spectrum Test App

The Spectrum Application is a dual-band Wi-Fi spectrum analyzer that measures Wi-Fi signal information to provide data about signal strength as well as noise. This application requires the NXT-1000 Portable Spectrum Analyzer (sold separately or included in kits), which plugs into the top USB port of your test unit.

This application offers:

- Frequency spectrum (heat map) display across the frequency band
- Waterfall display (2-minute historical) of RF
- Real time display of current, average, and max-hold signal levels

This information can help you identify both Wi-Fi and non-Wi-Fi sources in your environments.





Using the Spectrum Views

Opening the Spectrum app automatically changes the screen orientation and opens the default view: a Frequency Spectrum graph for the 2.4 GHz band. You can choose from three views of live data: Frequency Spectrum (heatmap), Waterfall, and Real Time.

Before You Begin



- Connect NetAlly's Spectrum dongle to the top USB port (USB Type-A) of your EtherScope nXG. (See [Contact NetAlly](#) to acquire the NXT-1000 Portable Spectrum Analyzer if you do not already have one.)
- Tap the Refresh icon  to clear the current graph and start new measurements.
- To get more accurate test results, NetAlly recommends that you turn off your device's management Wi-Fi and Bluetooth. (The Spectrum app notifies you if these services are turned on.)

To turn off management Wi-Fi and Bluetooth:

1. Swipe down from the top of the EtherScope screen to display the system icons.
 2. Tap the Wi-Fi icon  until it indicates that Wi-Fi is off .
 3. Tap the Bluetooth icon  until it indicates that Bluetooth is off .
- (Optional) See [Spectrum Settings](#) for instructions on changing the frequency band, changing the Waterfall View type, and saving settings.

Using Common View Actions

Use these actions in each Spectrum view to change the view details:

- **Pause:** Tap the Pause icon  to stop updates of the display. This can help you examine patterns and anomalies without updated data overriding your current view.
- **Resume:** Tap the Resume icon  to cancel a pause and continue live data updates.

- **Refresh:** Tap the Refresh icon  to clear the graph and start acquiring new data. (A refresh also cancels a pause.)
- **Display markers:** (Frequency Spectrum and Real Time views only) Tap the graph at a particular frequency that you want to examine. This displays a pink vertical marker at that frequency and lists the frequency's numerical details above the graph.
 - The Frequency Spectrum view displays the frequency and its maximum value.
 - The Real Time view displays the frequency, the frequency's current value, the average value, and the highest measured value (Max-Hold).
 - If you have a specific frequency detail marker, double-tapping on the marker erases it. (You can reset the marker by single-tapping the graph again.)
- **Zoom in:** Double-tap the view graph to zoom in to a narrower band around a particular frequency.

- For the 2.4 GHz band, the graph centers on a 40 MHz range around the channel closest to the frequency you tapped.
- The 5 GHz band, the graph centers on an 80 MHz range around the nearest of several predefined frequency ranges.
- **Restore to normal view:** Tap the Restore icon  to close the zoomed-in view, return to the full display for the frequency band, and refresh the graph with new data.
- **Saving results:** see [Uploading Results to Link-Live](#).

Frequency Spectrum View

This display uses the color spectrum to present a heatmap of the frequency band you have chosen, showing the density of recent RF measurements.

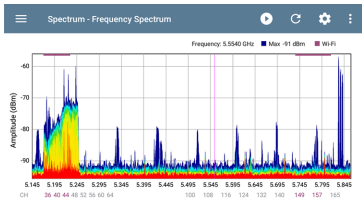

- Blues and greens ("cool" colors) indicate less RF detected at that frequency and amplitude.
- Yellow, orange, and red ("hot" colors) indicate the repeated presence of RF at that frequency and amplitude.
- Darkest blue indicates infrequent RFs while red indicates the continuous presence of RF at that amplitude.
- The top of the chart shows numerical details for display markers you have set and the Wi-Fi legend color.
- The range for the Y-axis (Amplitude) scales automatically according to data values.

- The X-axis displays channels and frequencies.
- The chart shows active Wi-Fi APs and clients by colorizing the channel numbers and by displaying a bar across Wi-Fi frequency range at the top of the chart.

Waterfall View

The Waterfall display draws new data at the top of the display as it scrolls older data downwards over a 2-minute interval. This provides a visualization of RF activity over time.

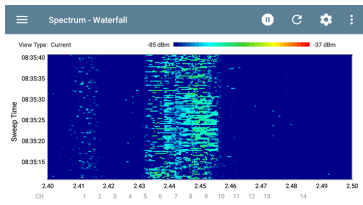

- The vertical axis shows the measurement time, and the horizontal axis shows frequencies and channels.

- The colors in the waterfall represent the amplitude of a frequency at a certain time according to the scale in the upper right. Dark blue shows lower amplitude measurements, and lighter colors show higher amplitude signals. More colors indicate more activity. For example, in the waterfall shown above, a speed test is running on Channel 8.
- The waterfall has two view types. Use Current to detect instantaneous RF. To smooth the data and see overall usage, change the type to Average 5 Sweeps, which averages five sweeps for each new line of data. This decreases the data resolution but may make the data easier to interpret in highly active RF environments. (See [Changing Spectrum Settings](#) for instructions on changing the type.)

Real Time View

The Real Time display shows the current values across the frequency band with colorized lines for the current measurement, the average measurement, and the highest measured value (Max-Hold).

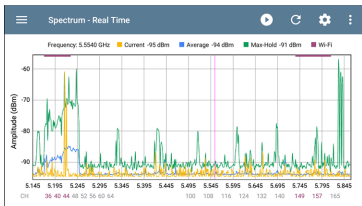

- Yellow lines indicates the current values.
- Blue line indicates the average values, which are calculated using all measurements accumulated since the graph was last cleared.
- Green lines indicate the highest measured value (Max-Hold).
- The top of the chart shows numerical details for display markers you have set and the Wi-Fi legend color.
- The range for the Y-axis (Amplitude) scales automatically according to data values.
- The X-axis displays channels and frequencies.

- The chart shows active Wi-Fi APs and clients by colorizing the channel numbers and by displaying a bar across active Wi-Fi frequency range at the top of the chart.

Uploading Results to Link-Live

To send your Spectrum results to the [Link-Live](#) website, tap the action overflow icon  at the top right of the Spectrum screen, and then tap **Upload graphs to Link-Live**.



Link-Live
by NetAlly



Graphs Image Name

20220309-012724

Comment

Enter Comment

Job Comment

Enter Job Comment



SAVE TO LINK-LIVE

The [Link-Live sharing screen](#) opens. The system creates a file name automatically using the date. You can also enter optional Comments and Job Comments to attach to the results file. The

results are displayed as images on Link-Live.com.

Spectrum Settings

The Spectrum navigation drawer allows you to change the data views, change frequency bands, change the Waterfall display type, and save settings.

Changing Spectrum Views

To change the Spectrum view:

1. Tap the Menu icon  to open the Spectrum [navigation drawer](#):

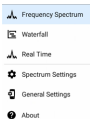

2. Select the view that you want: Frequency Spectrum, Waterfall, or Real Time. See [Using the Spectrum Views](#) for information on using these views.



Saving Settings

To save the current Spectrum settings, tap the Save icon  in the upper right corner of the

Spectrum Settings screen. This opens a menu for you to **Load**, **Save As**, **Import**, or **Export** any changes you make to the settings. See [Saving App Settings and Configurations](#) for more information.

Changing Spectrum Settings

The Spectrum settings allow you to change the frequency band and to change the waterfall view type.

To change settings, tap the settings  icon or tap the Menu icon  and select **Spectrum Settings** from the Spectrum [navigation drawer](#). Either action opens the Spectrum settings window:



To change the frequency band:

1. Tap **Wi-Fi Band**. This opens a selection box.
2. Tap the button for the frequency band you want, and then tap **OK** to return to Spectrum Settings.
3. Tap the back button  to return to the Spectrum view.

To change the waterfall view type:

1. Tap **Waterfall View Type**. This opens a selection box.
2. Tap the button for either **Current** or **Average-5 Sweeps**.
 - **Current** maintains the default display for the Waterfall view.
 - **Average-5 Sweeps** averages each line of waterfall data into five sweeps. This decreases some of the data resolution but may make the data easier to understand in highly active environments.
3. Tap **OK** to return to Spectrum Settings.

4. Tap the back button  to return to the Spectrum view.



Performance Test App

The EtherScope nXG's line rate Performance Test provides point-to-point performance testing of a traffic stream across wired IPv4 network infrastructure. This test quantifies network performance in terms of target rate, throughput, loss, latency, and jitter.

The Performance test exchanges a stream of traffic with Peers or Reflectors and measures the performance of the traffic stream. You can simulate real-world traffic by configuring traffic flow, frame size, VLAN, and QoS options. Run the test at a full line rate of up to 10 Gbps for performance validation, or run at lower speeds to minimize disruption when troubleshooting operational networks.

The Performance Test runs from the [Wired Test Port](#) (top RJ-45 or Fiber port), and an [AutoTest Wired Profile](#) must connect successfully to establish link on the port. When you start up the EtherScope, the last Wired Profile in the list of active AutoTest profiles runs automatically if an active Ethernet connection is detected on the top RJ-45 port. Otherwise, you may need to manually run a Wired AutoTest to link. See [Wired AutoTest Profiles](#) to review.

Introduction to Performance Testing

Network performance is measured between a *Source* device, on which the test is configured and controlled, and up to four *Endpoint* devices that exchange traffic with the source. There are two endpoint types: Peers and Reflectors.

When using a Peer endpoint, separate upstream and downstream measurements can be shown for Throughput, Loss, Latency, and Jitter.

When using a Reflector, the EtherScope reports round-trip data for all measurements. Separate upstream and downstream traffic measurements are not possible.

The EtherScope nXG can act as the controlling Source for the performance test or as a Peer for a test conducted by different source device, such as another EtherScope nXG or a OneTouch AT 10G.

Other NetAlly testers work with the EtherScope to perform network performance testing:

- **OneTouch AT 10G** can act as the Source or a Peer for Performance tests.
(NetAlly.com/products/OneTap)
- **LinkRunner AT** and **LinkRunner G2** each have a Reflector feature for exchanging Performance test traffic.
(NetAlly.com/products/LinkRunner G2)
- NetAlly's **Network Performance Test (NPT) Reflector** PC application can also act as the reflector for a Performance test. Download the free NPT Reflector software from Link-live.com/downloads. Select EtherScope nXG from the drop-down menu to view the list of downloads.

In this Chapter

Performance Test Settings



Configuring Performance Endpoints

Running a Performance Test

Running EtherScope as a Performance Peer

Performance Test Settings

The Performance app has both **Performance** settings that apply when the EtherScope is acting as the test source, and **Peer** settings that control the unit when it is acting as the test Peer.

Access the settings by tapping the settings button  on the Performance Test screen or the [Performance Peer](#) screen, or open the left-side [navigation drawer](#)  in the Performance app.

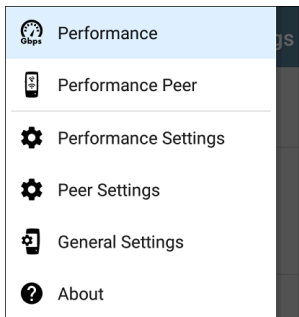

Performance goes to the main Performance test results screen.

Performance Peer opens the Peer results screen.

Performance Settings control the performance test settings when the EtherScope is the source.

Peer Settings control the EtherScope Performance Peer when another device is the source. See [Running EtherScope nXG as a Performance Peer](#).



Saving Custom Performance Tests

The Performance app allows you to save two levels of test configurations: individual **Services** and complete **Performance Tests** with *up to eight* enabled Services.

- **Services** include the Endpoint, Frame Size, Bandwidth, grading Thresholds, and Layer 2 and 3 Options. Services can be used in any number of saved Performance Tests.
- Saved **Performance Tests** contain a test Duration setting and the included Services.

For example, you can configure Services for multiple endpoints at different locations and with different bandwidths. A user can also create multiple Services with different QoS priorities (using the Layer 3 options) to verify that loss does not occur over the higher priority stream.

Saved Performance Tests and their Services work much like AutoTest Profile Groups, Profiles, and Test Targets. See the [AutoTest Overview](#) to review.

Open the Performance Settings screen  from the main Performance results screen or the left-side [navigation drawer](#) .

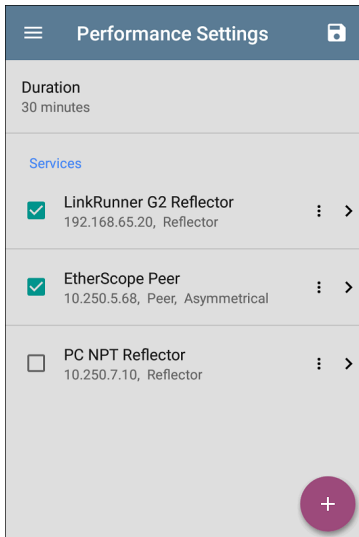

Tap the save icon  to load, save, import, or export a settings configuration.

- **Load:** Open a previously saved settings configuration.

- **Save As:** Save the current settings with an existing name or a new custom name.
- **Import:** Import a previously exported settings file.
- **Export:** Create an export file of the current settings, and save it to internal or connected external storage.

See [Saving App Settings Configurations](#) for more instructions.

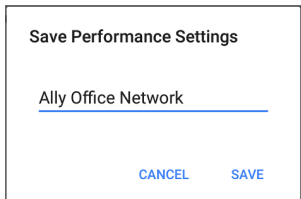

In the example images here, the user has saved a custom Performance Test called "Ally Office Network."



The screenshot shows the 'Performance Settings' screen for a configuration named 'Ally Office Network'. At the top, there is a blue header with a hamburger menu icon on the left, the title 'Ally Office Network' in the center, and a save icon on the right. Below the header, the 'Duration' is set to '30 minutes'. Underneath, there is a section titled 'Services' in blue. A single service, 'LinkRunner G2 Reflector', is listed with a green checkmark on the left, the IP address '192.168.65.20, Reflector' below it, and a vertical ellipsis and a right-pointing arrow on the right.

Once you save a Performance Test configuration, the custom name you entered appears at the top of the Performance Settings screen (above) and main Performance Test screen (below).

The screenshot shows the main 'Performance Test' screen for the 'Ally Office Network' configuration. The blue header contains a hamburger menu icon, the title 'Performance', and a 'STOP' button. The main content area has a white background and features a speedometer icon with 'Gbps' below it, followed by the title 'Ally Office Network'. Below the title, the test details are listed: 'Duration: 1 minute', 'Started: 3:27:07 PM', and 'Status: Next update in 26 seconds'. A table with four columns is shown: 'Loss', 'Latency', and 'Jitter'. Below the table, the service 'LinkRunner G2 Reflector' is listed with a refresh icon on the left and a right-pointing arrow on the right. The table rows show dashes for all metrics.

	Loss	Latency	Jitter
LinkRunner G2 Reflector	--	--	--

Configuring the Source EtherScope nXG

Open the Performance Settings screen from the main Performance results screen  or the left-side [navigation drawer](#) .

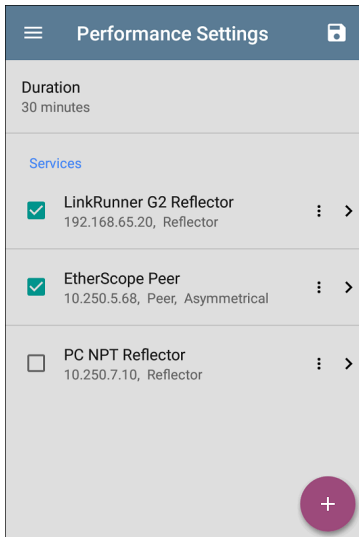

Performance Settings

Duration
30 minutes

Services

- LinkRunner G2 Reflector
192.168.65.20, Reflector
- EtherScope Peer
10.250.5.68, Peer, Asymmetrical
- PC NPT Reflector
10.250.7.10, Reflector

+

Changed settings are automatically applied. When you finish configuring, tap the back button  to return to the Performance test screen.

Duration: This setting is the length of time the Performance test runs. Tap the field to select a new duration. The default is 1 minute.

Services

A Service is a configured traffic flow that simulates application traffic. You can run up to four unidirectional or bidirectional services simultaneously to emulate and test the QoS levels on your network.

The Services configurations include the Endpoints, Frame Size, Bandwidth, Thresholds, and Options the EtherScope uses to measure and grade performance.

Your collection of configured Services is available across all of your saved Performance Test configurations, and if you delete a Service, it is deleted from all Performance Tests.

On the Performance Settings screen, you can perform the following actions:

- Check or uncheck the boxes to include or exclude Services in the list of active Performance tests.

NOTE: You can run a Performance Test on up to eight Services at once. If you select more than eight Services, the Performance Test fails.

- Tap the action overflow icon  to **Duplicate**, **Move Up/Down**, or **Delete** a configured Service.

CAUTION: When you delete a Service, you delete it from all Performance Test configurations. To remove a Service from the current test, simply uncheck it.

NOTE: All Services are tested at the same time, so the order of Services listed on this screen does not affect how the test runs.

- Tap the **FAB** icon  to add a new Service.
- Tap any Service's name, or add a new Service, to open its settings, where you can enter a custom Service name, endpoint address, performance thresholds, and other Service characteristics.

Service	
Service Name LinkRunner G2 Reflector	
Endpoint Device 10.250.3.112, Reflector	>
Frame Size 512 Bytes	
Bandwidth Rate: 1 Mbps	>
Thresholds Loss: 0.3 %, Jitter: 20 ms, Latency: 100 ms	>
Layer 2 Options VLAN Overrides: Disabled	>
Layer 3 Options TOS: Default (0)	>

Service Name

Tap the **Service Name** field to enter a custom name for the endpoint and associated settings.

This name appears on the Services screen and the Performance test screen.

Endpoint Device

Open this screen to configure the Endpoint Address, Type, and Traffic Flow.

☰	Endpoint Device
IPv4 Address	10.250.2.187
Communication UDP Port	3842 (netally-perf)
Endpoint Type	Peer
Traffic Flow	Asymmetrical

IPv4 Address: Tap the field to enter the IPv4 address of your endpoint device.

Communication UDP Port: If needed, tap to enter a different UDP Port number. The default NetAlly performance test port is 3842.

NOTE: The UDP port number entered here must match the port number used by your Peer endpoint device.

Endpoint Type: Select **Peer** or **Reflector** depending on the type of endpoint you are using for the performance test.

Traffic Flow: This setting only appears when **Endpoint Type** is set to **Peer**.

- Select **Upstream only** or **Downstream only** to test only the single traffic flow direction specified.
- Select **Asymmetrical** to test each direction using a different **Target Rate** (set under **Bandwidth** below). Asymmetrical is the default traffic flow for a Peer endpoint.
- Select **Symmetrical** to test both directions using the same Target Rate.

Frame Size

Tap the **Frame Size** field to select a new single frame size, the Frame Size Mix option, or to enter a Custom Value. The default is 512 bytes.

Frame Size

128 Bytes

256 Bytes

512 Bytes

1024 Bytes

1518 Bytes

9600 Bytes

Frame Size Mix abceg 

Custom Value 

[CANCEL](#) [OK](#)

Selecting **Frame Size Mix** creates traffic with variable frame size patterns, generated in a repeating sequence. Tap the edit icon  to revise the frame size pattern.

Frame Size Mix

Mix: abceg

User Size: 512 Bytes

<	⌫	>
a 64	b 128	c 256
d 512	e 1024	f 1280
g 1518	h 9600	u User

CANCEL OK

On the Frame Size Mix keyboard shown above, each letter (a through h) is associated with a frame size. The default pattern is "abceg," meaning the traffic pattern follow a repeating sequence of 64, 128, 256, 1024, and 1518 bytes. Use the letter keys along with the arrows and backspace button to edit the mix sequence as desired.

The **u** key enters a user-defined size into the mix. Select the field next to **User Size:** to enter your desired frame size, between 64 and 9600 bytes. Tap the **u** key to insert the new size where you want it in the pattern.

NOTE: If the Performance Test runs on a VLAN (configured in the Wired AutoTest Profile or the Performance Layer 2 options shown below), the frame sizes are four bytes longer. You do not need to account for this frame size increase in the settings.

Bandwidth

Tap to open the **Bandwidth** screen and select or enter a **Target Rate** for one or both traffic directions.

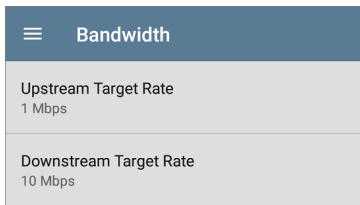

Bandwidth	
Upstream Target Rate	1 Mbps
Downstream Target Rate	10 Mbps

- If you are configuring a Reflector endpoint or you have selected Symmetrical Traffic Flow for a Peer endpoint, only one Target Rate is used.
- For a Peer with an Asymmetrical Traffic Flow configuration, you can select a different Upstream and Downstream Target Rate for each direction.

Tap the **Target Rate** field(s) to select or enter a new rate.

Upstream Target Rate

1 Mbps

10 Mbps

100 Mbps

999.8 Mbps

Target Rate: The requested rate of round-trip traffic

Upstream Target Rate: This is the requested rate of upstream traffic, from the source to the endpoint.

Downstream Target Rate: This is the requested rate of downstream traffic, from the endpoint to the source.

NOTE: The 99.98 Mbps and similar values provided in the Target Rate options are meant to test the maximum, worst case throughput on an Ethernet link. Though greater rates are possible under perfect conditions, the limitation of 99.98% of the link rate results from asynchronous clocks in Ethernet. The IEEE 802.3 Ethernet standard allows link partners to differ by up to 0.02% of their clock signals. Therefore, end-to-end throughput in the worst case may be limited to 99.98% of the source link rate when the traffic traverses a link and maximum clock differences occur between the two link partners.

Thresholds

Thresholds define the **Pass/Fail** criteria the EtherScope uses to grade the test. The

Performance Test thresholds are Frame Loss, Jitter, and Latency.

- If you are configuring a Reflector endpoint or you have selected Symmetrical Traffic Flow for a Peer endpoint, the same threshold values grade each traffic direction.
- For a Peer with an Asymmetrical Traffic Flow configuration, you can select different Upstream and Downstream thresholds.

Thresholds	
Upstream	
Frame Loss Threshold	Disabled
Jitter Threshold	20 ms
Latency Threshold	100 ms
Downstream	
Frame Loss Threshold	0.2%

Tap each Threshold field to select or enter the maximum value allowed. If a measured value exceeds the threshold value, the test fails.

Frame Loss Threshold: The Frame Loss Threshold is the percentage of frames that can be lost before the test fails. The default is 0.3%. Tap the field to select or enter a new threshold or to disable grading based on frame loss altogether.

Jitter Threshold: Jitter is a measure of the variation in frame-to-frame latency in milliseconds. The default threshold is 20 ms.

Latency Threshold: Latency is the amount of time it takes for a packet to go from the source to the endpoint and endpoint to source in milliseconds. The default threshold is 100 ms.

Layer 2 Options

The Performance Test runs over the [Wired Test Port](#) link established by an [AutoTest Wired Profile](#). Therefore, by default, the Performance Test runs using the VLAN ID configured in the settings of the Wired AutoTest Profile that established the link.

To test other VLANs, for example, those that make up a trunk port, configure the Layer 2 Options in your separate Services to test the corresponding VLANs.

Open **Layer 2 Options** in the Performance app settings to override the VLAN settings from AutoTest.

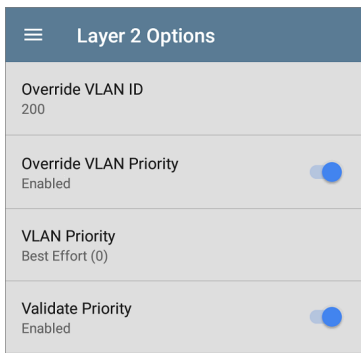

Override VLAN ID: Tap to select or enter a VLAN ID number. The Override VLAN ID function tags frames with a particular VLAN (for example, a VLAN used for voice, video, or data). If Override

VLAN ID is not enabled, the VLAN is set to the value used for the Wired Test port.

Override VLAN Priority: Tap the toggle button to enable. By default, the VLAN priority is set to Best Effort (0). Use this setting to simulate a traffic stream of a certain type. If Override VLAN Priority is not enabled, the VLAN priority is set to the value used for the Wired Test port.

VLAN Priority: This setting only appears if the **Override VLAN Priority** setting above is Enabled. Tap to select a VLAN Priority.

Validate Priority: Tap the toggle button to enable the EtherScope to validate the selected VLAN priority. When the Validate Priority option is enabled, EtherScope checks the packets it receives to ensure that the priority field has been maintained from source to destination. If it has been altered, packets are counted as lost and included in the Frame Loss measurement.

Layer 3 Options

Layer 3 options are useful when testing QoS (Quality of Service) on your network. You can create up to four Services using different DSCP

priority or IP precedence to verify that loss does not occur on the higher priority streams.

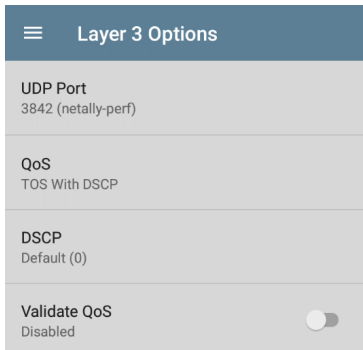

Layer 3 Options	
UDP Port	3842 (netally-perf)
QoS	TOS With DSCP
DSCP	Default (0)
Validate QoS	Disabled <input type="checkbox"/>

UDP Port: Tap to enter a specific UDP port number. This can help you simulate prioritized traffic on ports reserved for specific uses such as video, voice, or backup data or to match ports allowed by a firewall.

QoS: Select the methodology used on your network: **TOS with DSCP** (Type of Service with Differentiated Services Code Point or **TOS with IP Precedence** (legacy). Then, configure the priority using the settings below.

DSCP: This field is only available when **TOS with DSCP** is selected in the setting above. Using the DSCP control, you can specify a priority for the generated traffic by changing its classification. This is a six-bit field. The default value of zero specifies “Best Effort.” Tap the field to select a different DSCP.

IP Precedence: This field is only available when **TOS with IP Precedence** is selected. Tap the field to select an IP Precedence other than the default of Routine (0).

IP Precedence Type: This field is also only available when **TOS with IP Precedence** is selected. Tap the field to select an IP Precedence Type other than the default of Normal (0).

Validate QoS: When this setting enabled, the EtherScope checks received packets to ensure that the QoS field has been maintained throughout the route. If the QoS field has been altered, packets are counted as lost.

Configuring Performance Endpoints

EtherScope nXG can run a Performance Test to any of the following Endpoints:

- Another EtherScope nXG (Peer)
- A OneTouch AT 10G (Peer)
- A LinkRunner G2 or LinkRunner AT (Reflector)
- NPT Reflector Software (Reflector)

See our website NetAlly.com for more information about [OneTouch](#) and [LinkRunner](#) and to download the free NPT Reflector PC application.

EtherScope Performance Peer

To run an EtherScope nXG as a Performance Peer, see the [Running as a Performance Peer](#) topic.

OneTouch 10G Performance Peer

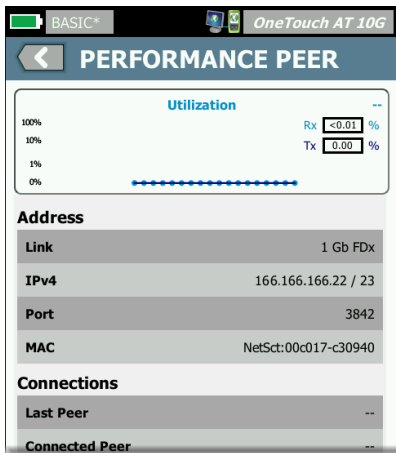

Follow these steps to set up a OneTouch 10G Performance Peer:

1. Ensure the OneTouch is connected to an active network via the top RJ-45 or Fiber test port and is plugged into AC power.

2. With the unit powered on, tap the TOOLS  icon on the Home screen.
3. In the TOOLS menu, select **Testing Tools > Performance Peer**.
4. Select the appropriate UDP **Port** number if other than the default of 3842.
NOTE: The port number set on your endpoint must match the port number used by your source EtherScope.
5. Turn on **Enable AutoStart** to cause the Performance Peer function to start automatically when the OneTouch is powered on.
6. Tap the **START** button.
The PERFORMANCE PEER screen appears, and a network link is automatically established.
7. The IPv4 address of the peer is displayed on the screen. Enter this address on the [Endpoint Device](#) screen in the EtherScope nXG's Performance test Services settings.

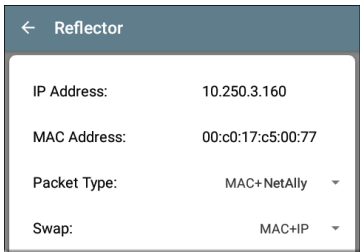

For additional details on the OneTouch Performance Peer, [see the OneTouch 10G User Manual, available online.](#)

LinkRunner G2 Reflector



Follow these steps to set up a LinkRunner G2 Reflector:

1. Ensure the LinkRunner is connected to an active network via the top RJ-45 or Fiber test port and is plugged into AC power.
2. Start the LinkRunner G2 testing application by tapping the NetAlly logo  at the bottom of the screen.

- In the testing app, open the left-side [navigation drawer](#) by tapping the menu button .
- Select **Reflector**  .
- Configure the **Packet Type** and **Swap** settings as required. The default settings, Packet Type: MAC + NetAlly and Swap: MAC + IP, are recommended to avoid any undesired traffic on your network.
- Once the LinkRunner G2 Reflector has acquired an IP address, tap the floating action button (FAB)  at the lower right to start the Reflector.
- The IP address of the Reflector is displayed at the top of the screen. Enter this address on the [Endpoint Device](#) screen in the EtherScope nXG's Performance Test Services settings.

For additional details on the LinkRunner G2 Reflector feature, see the User Guide on the LinkRunner G2 Home screen.



LinkRunner AT Reflector

Reflector	
IP Address:	192.168.001.090
MAC Address:	00-C0-17-B6-86-0C
Packet Type:	MAC+NetAlly
Swap:	MAC+IP

Reflector Mode



Configure

1000
FDx

Start

Follow these steps to set up a LinkRunner AT (2000) Reflector:

1. Ensure the LinkRunner is connected to an active network via the RJ-45 or Fiber test port and is plugged into AC power.
2. On the Home screen, select **Tools**.
3. In **General Configuration > Manage Power**, ensure the **Auto Shutoff Enabled** is unchecked to prevent the unit from powering down during the test. **Save** the changed setting.
4. In the Tools menu, select **Reflector**.

5. On the Reflector Screen, **Configure** the **Packet Type** and **Swap** settings as required. The default settings, **Packet Type: MAC + NetAlly** and **Swap: MAC + IP**, are recommended to avoid any undesired traffic on your network.
6. Select **Save** to apply any changed settings.
7. Select **Start** (F2) to run the Reflector.
8. The IP address of the Reflector is displayed at the top of the screen. Enter this address on the **Endpoint Device** screen in the EtherScope nXG's Performance test Services settings.

For additional details on the LinkRunner AT Reflector feature, [see the LinkRunner AT User Manual, available online.](#)

NPT Reflector Software



Follow these steps to set up the NPT Reflector PC application:

1. Download the software from Link-live.com/downloads. (Select Ether-Scope nXG from the drop-down menu to view the list of downloads.)
2. Install the Reflector on your PC by running the .exe file.
3. Open the Reflector application.

Once open, the application automatically detects available network interfaces and their link status.

4. Check the box next to **Enable Reflection** for each network interface you want to use as a Reflector Endpoint for your Performance Test.
5. Leave the application window open on your PC during Performance testing.
6. Enter IP addresses for the interfaces you want to test against on the [Endpoint Device](#) screen in the EtherScope nXG's Performance Test Services settings.

Refer to the **Help** in the NPT Reflector software for additional information.

Running a Performance Test

Note the following before running:

- The Performance Test can only run from the [Wired Test Port](#) (top RJ-45 or Fiber port), and an [AutoTest Wired Profile](#) must connect successfully to establish link on the port. If you receive a Status message such as "The wired test port is not linked" or "No IP address" but you have an active network connection, go to AutoTest and run a Wired Profile to troubleshoot your connection.
- All configured Performance Test [Services](#) are tested at the same time. If one Service fails to meet the thresholds for the test, the entire test fails.
- Only four Services can run at once. If you have selected more than four Services in the [Performance Settings](#), the test fails with the Status message, "Too many services enabled (56)."

- Newly configured Services may not display on the main Performance Test screen until you tap **START**.

To run your configured Performance Test, tap **START** on the main Performance screen.

Performance Test Results

☰
Performance
START
⚙️
⋮



New Performance Test

Duration: 10 minutes
 Started: 11:16:22 PM
 Status: Test failed, thresholds exceeded (6)

	Throughput	Loss	Latency	Jitter
--	------------	------	---------	--------

↻

LinkRunner G2 Reflector

>

	1 Mbps	<0.001 %	60 us	<1 us
--	--------	----------	-------	-------

↕

EtherScope Peer

>

● ↑	939.4 Kbps	6.1 %	56 us	<1 us
● ↓	939.4 Kbps	6.1 %	55 us	1 us

↻

PC NPT Reflector

>

	1 Mbps	0 %	223 us	105 us
--	--------	-----	--------	--------

Performance results update every five seconds if you are using only Reflector endpoints, and/or an EtherScope nXG Peer running v1.2 or newer software, with a test Duration of 4 hours or less. If you are running a 10 second test, all results display after 10 seconds. Otherwise, results update every 30 seconds.

Performance Test results are presented on cards. The top card shows the test duration and status.

Duration: The test duration selected in the Performance Settings

Started: Time at which the test began

Status: Current status of the test, including any error messages

Each card beneath corresponds to a configured Service and displays the Up, Down, or Round Trip measurements for Throughput, Loss, Latency, and Jitter. Remember, Peer endpoints can return Upstream and Downstream measurements, while Reflectors only provide round trip measurements.

Tap a Service card to view more details.

Performance Service Detailed Results

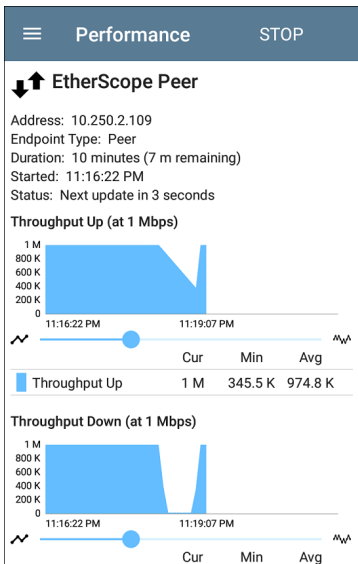

The Service results screen displays detailed test characteristics and graphs of performance.

Address: IP address of the endpoint

Endpoint Type: Peer or Reflector

Status: Current status of the test, including any error messages

Rerunning Tests from Detailed Results

You can rerun a Performance Test from the detailed results screen by tapping **Start** at the top of the screen. This repeats the Performance Test *only* for the Service that you are viewing.

Throughput, Loss, Latency, and Jitter Graphs

The graphs described in this section update every 5 or 30 seconds for as long as the test is running. The graphs save and display data for the entire test duration, with a max duration of 24 hours.

Peer endpoints display separate Up and Down graphs (as shown below) for Throughput, Frames Lost, Latency, and Jitter, while Reflector endpoints display one round trip measurement for each.

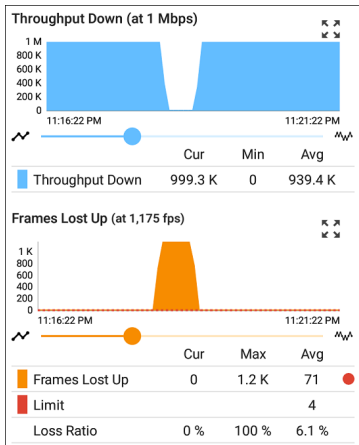

Touch and drag (or swipe) left and right on each graph to move backward and forward in time, and double tap or move the slider to zoom in and out. See the [Trending Graphs](#) topic for an overview of the graph's pan and zoom controls.

Graph Legends

Under each graph, a legend table indicates the meanings of the colors that correspond to

different measurements. The **Limit** shown for each graph is the set Threshold from the corresponding [Service settings](#). Measurements that fall outside the Limit are indicated with a red dot next to the failing measurement. In the image above, the test has failed because Frames Lost Up was above the Limit.

The table also displays the Current, Maximum, and Average measurements. The Current columns contain measurements from the last interval (5 or 30 seconds). The Min, Max, and Avg columns show cumulative measurements gathered during the test duration.

Throughput

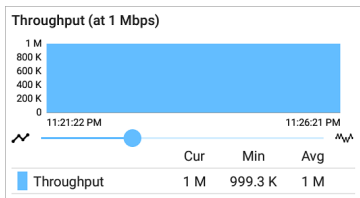

Throughput (Up/Down) (at Target Rate):

Throughput is the measured bit rate based on the number of frames sent and frames received.

The configured Target Rate from the Performance Settings is shown in parentheses next to the Throughput heading. In the image above, the configured Target Rate is 1 Mbps.

Loss

Frames Lost Up (at 1,175 fps)



	Cur	Max	Avg
Frames Lost Up	0	5.9 K	279.8
Limit			18
Loss Ratio	0 %	100 %	4.8 %

Frames Lost Down (at 2,350 fps)



	Cur	Max	Avg
Frames Lost Down	0	11.7 K	559.5
Limit			35
Loss Ratio	0 %	100 %	4.8 %

Frames Lost (Up/Down): Frame loss is quantified by the number of frames received subtracted from the number of frames sent.

Limit: This is the Frame Loss Threshold for one interval. It is computed from the Frame Loss

Threshold, Frame Size, and Bandwidth settings for the Service. The Limit is also displayed on the graph as a horizontal red dotted line (if the measurements are close enough to the Limit value for it to appear on the graph).

Loss Ratio: The percentage of total frames that were lost

NOTE (for 10G Rate Performance tests): Low-level electrostatic discharge (ESD) and low-power Electric Fast Transient (EFT) events, also called impulse noise, can interfere with newer, faster data links with less noise margin. These events could include static from a person's clothing or interference from electrical appliances and motorized equipment. When running a full 10G line rate test, ESD and EFT events can cause periodic spikes or a spike that then resolves on the Frame Loss graph.

Latency

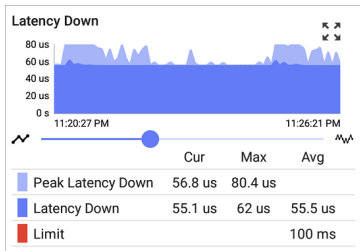

Latency (Up/Down): Latency is the amount of time it takes for a packet to go from the source to the endpoint or from the endpoint to the source (in milliseconds). Latency is calculated by averaging the thousands of latencies measured during each interval. One-way latency measurements consist of the round-trip measurements divided by two.

Peak Latency: The highest measured latency. The Current column shows Peak Latency from the last test interval, and Max shows the highest latency measured during the entire test.

Limit: This is the Latency Threshold from the Performance app's setting.

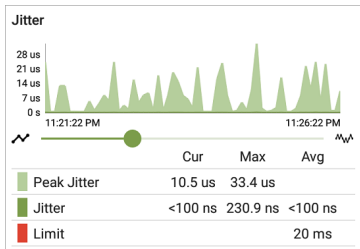



Jitter (Up/Down): Jitter is a measure of the variation in frame-to-frame latency in milliseconds.

Peak Jitter: The highest measured Jitter. The Current column shows Peak Jitter from the last test interval, and Max shows the highest Jitter measured during the entire test.

Limit: This is the Jitter Threshold from the Performance app's settings.

Uploading Results to Link-Live

Tap the action overflow icon  at the top right of the main Performance test screen, and select **Upload to Link-Live** to send the latest results to the Results page  on Link-Live.com.

**Link-Live**

by NetAlly

**Comment****Job Comment****SAVE TO LINK-LIVE**

An image file of a complete Service results screen, including all the graphs, can also be uploaded to Link-Live and attached to the main test results. From the main Performance test

screen, tap a Service card to view the Service detailed results, then tap the action overflow icon  at the top right of the screen, and select **Upload graphs to Link-Live**.

**Link-Live**
by NetAlly



Performance Result Filename

New Performance Test - 1 - LinkRunner

Comment

Enter Comment

Job Comment

Performance Main Offices

 **SAVE TO LINK-LIVE**

See the [Link-Live chapter](#) for more information.

Running EtherScope nXG as a Performance Peer

In addition to running a Performance Test as the controlling source device, EtherScope nXG can also act as a Peer for another EtherScope nXG or a OneTouch AT 10G acting as the source and controller.

To access the EtherScope Performance Peer, tap the menu button  in the Performance app and select **Performance Peer**.

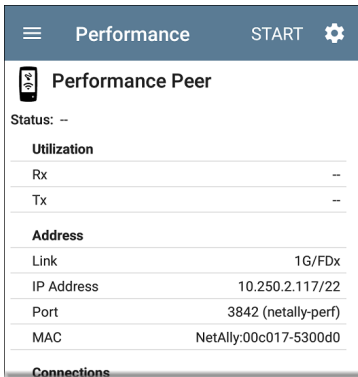

The screenshot shows the Performance app interface. At the top, there is a dark blue header with a menu icon (three horizontal lines), the word "Performance", the word "START", and a gear icon for settings. Below the header, there is a section titled "Performance Peer" with a small icon of a device. Underneath, the status is shown as "Status: --". There are two sections: "Utilization" and "Address". The "Utilization" section has two rows: "Rx" and "Tx", both with "--" values. The "Address" section has four rows: "Link" with "1G/FDx", "IP Address" with "10.250.2.117/22", "Port" with "3842 (netally-perf)", and "MAC" with "NetAlly:00c017-5300d0". At the bottom, there is a section titled "Connections".

Utilization	
Rx	--
Tx	--

Address	
Link	1G/FDx
IP Address	10.250.2.117/22
Port	3842 (netally-perf)
MAC	NetAlly:00c017-5300d0

Connections

The [Wired Test Port](#) must be linked (by running an [AutoTest Wired Profile](#)) for the Performance Peer function to run. If the port is not linked, a Status message displays, "The wired test port is not linked."

Performance Peer Setting

The only setting for the Performance Peer function is the **Communication UDP Port**.

Tap the settings button on the Performance Peer screen to change the port number. The default NetAlly performance test port is 3842.

NOTE: The UDP port number entered here must match the port number used by your source device.

Running the Peer

Tap **START** on the Performance Peer screen to start the Peer.

Performance		STOP
	Performance Peer	
Status: Running		
Utilization		
Rx		1.02 %
Tx		1 %
Address		
Link		1G/FDx
IP Address		10.250.2.244/22
Port		3842 (netally-perf)
MAC		NetAlly:00c017-5300d0
Connections		
Last Peer		10.250.2.247
Connected Peer		10.250.2.247
Time Remaining		4 minutes 23 seconds

The screen displays real-time status, utilization, and rates for as long as the test is running.

Status: The current status of the peer

Utilization

Rx: Receive percentage of the link speed

Tx: Transmit percentage of the link speed

Address

Link: Link speed and duplex of the established Wired Test Port connection

IP Address: Address of the EtherScope to be entered into the controlling source device

Port: UDP Communication port in use by the peer

MAC: The EtherScope's MAC address

Connections

Last Peer: Address of the previous peer that was connected to the EtherScope

Connected Peer: Address of the peer that is currently connected to the EtherScope

Time Remaining: Amount of time left for the current test



iPerf Test App

iPerf is a standardized network performance tool used to measure UDP or TCP throughput and loss.

The iPerf app runs an iPerf3 performance test to a NetAlly Test Accessory or an iPerf server endpoint.



The NetAlly Test Accessory runs network connection tests, uploads results to [Link-Live Cloud Service](#), and acts as an iPerf server endpoint for iPerf tests run by other NetAlly handheld testers.

Learn more about the Test Accessory from [NetAlly.com/products/TestAccessory](https://netally.com/products/TestAccessory).

If you are using an iPerf server installed on a PC or other device as an endpoint, iPerf version 3 is required to run the EtherScope iPerf test. You can download iPerf server software from <https://iperf.fr>.

iPerf Settings

To run an iPerf test, you must configure your EtherScope unit to communicate with your iPerf endpoint. You can manually enter an iPerf server address, or select a NetAlly Test Accessory's address in the iPerf settings.

Saving Custom iPerf Settings

The iPerf app allows you to save a configuration of settings for running an iPerf test to the same endpoint later.

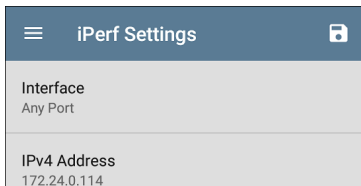

Tap the save icon  to load, save, import, and export configured settings. See [Saving App Settings Configurations](#) for more instructions.

Once you save a settings configuration, the custom name you entered appears at the top of

the iPerf settings and results screens. In the example images here, the user has saved a custom iPerf configuration called "Server Room Endpoint."

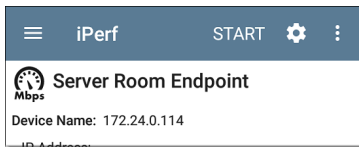
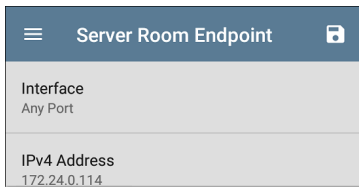



Test Accessories in Discovery

You can start an iPerf test from the Details screen for a Test Accessory in the [Discovery app](#) using the floating action button.

1. Open the Discovery app, and select an active **Test Accessory** from the main

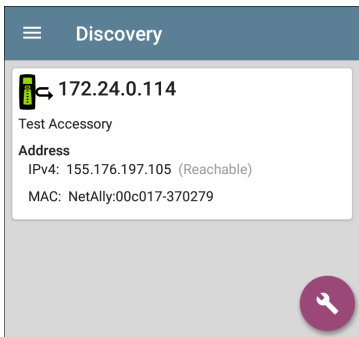
Discovery list to open its Details screen.



2. Tap the floating action button ([FAB](#)) to open the action menu. 



3. Select the **iPerf** app button to open the iPerf app with the IP address populated from the Test Accessory in Discovery.

NOTE: You can also select **Browse** in the FAB menu to open the Test Accessory's Web Interface, where you can view its status and configure its settings.

Configuring iPerf Settings

To configure the iPerf test settings manually, open the settings  on the iPerf screen.

iPerf Settings 	
Interface	Any Port
IPv4 Address	172.24.0.114
Port	5201 (iperf3)
Duration	10 seconds
Protocol	TCP
Direction	Upstream/Downstream
Upstream Threshold	10 Mbps

Server Room Endpoint	
IPv4 Address	10.250.3.182
Port	5201 (iperf3)
Duration	10 seconds
Protocol	TCP
Direction	Upstream/Downstream
Upstream Threshold	10 Mbps
Downstream Threshold	10 Mbps

Tap each field to enter or revise selections as needed. Changed settings are automatically applied. When you finish configuring, tap the back button  to return to the iPerf test screen.

Interface: This setting specifies which EtherScope port runs the scan. (See [Selecting Ports](#) for explanations of the different ports.)

IPv4 Address: Tap the field to enter or select the IPv4 address of the target iPerf server. Only IPv4 addresses are allowed for iPerf testing.

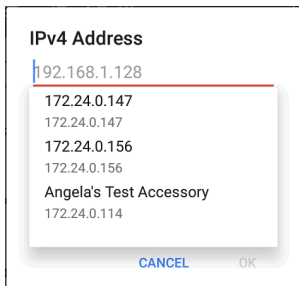

A drop-down list in the IPv4 Address dialog shows all the Test Accessories the EtherScope has discovered through the [discovery process](#), as well as any Test Accessories that are claimed to the same [Link-Live](#) organization as your EtherScope.

NOTE: Clear the address field in the dialog to see the full list of discovered Test Accessory addresses.

Port: The default iPerf3 port number is 5201. Tap the field to enter a different port number.

NOTE: The iPerf port number entered here must match the port number used by your iPerf server. If needed, consult the Test Accessory User Guide (NetAlly.com/products/TestAccessory).

Duration: This setting is the length of time for one direction, Upstream or Downstream, of the iPerf test. If the Direction setting below is set to both Upstream/Downstream, the total test time is twice the value set here. Tap the field to select a new duration or enter a custom value. The default is 10 seconds.

Protocol: TCP is the default protocol. Tap the UDP selector to switch to UDP.

NOTE: iPerf tests running the TCP protocol automatically run at the fastest rate possible. When running a UDP protocol test, the iPerf app attempts to run at the selected Bandwidth.

Direction: You can run an iPerf test Upstream, Downstream, or both. The default is Upstream and Downstream. Tap this field to set the test for only one direction.

Upstream and Downstream Bandwidth: These fields only appear if the **UDP Protocol** is selected. They specify the desired target bandwidth for the iPerf Test using the UDP protocol.

Upstream and Downstream Thresholds: Thresholds are the values the EtherScope uses to grade the test as **Pass** or **Fail**. iPerf thresholds are throughput rates. The default is 10 Mbps. Tap the threshold fields to select a different value or enter a custom one.

Running an iPerf Test

Ensure that you have an active link on the Interface ([Test Port](#)) from which you are running the iPerf test. Wired and Wi-Fi test ports require that an AutoTest Wired or Wi-Fi Profile has run to establish a link. The AutoTest Wired Profile runs automatically, but you must open the AutoTest app to run a Wi-Fi Profile and link on the Wi-Fi test port. Management ports link automatically if a connection is available.

Tap the **START** button on the main iPerf screen to begin testing.

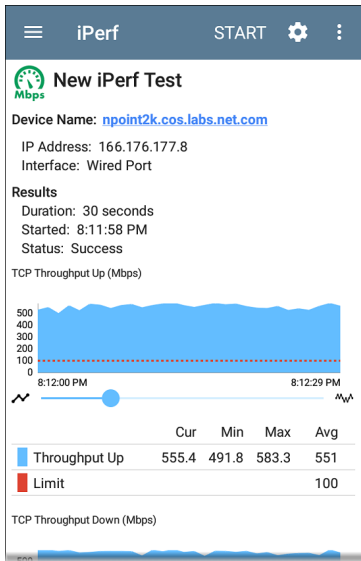

Test characteristics and status are displayed at the top of the iPerf results screen while the lower part of the screen displays a real-time graph of the TCP or UDP Upload and/or Download speeds.

To pan and zoom on the graphs, you can swipe, double tap, and move the slider. See the [Trending Graphs](#) topic for an overview of the graph controls.

Device Name: Hostname or address of the iPerf server or Test Accessory.

IP Address: IPv4 address of the iPerf server.

Interface: The EtherScope Test Port from which the test is running.

Results

- **Duration:** Configured Duration from the iPerf settings
- **Started:** Time the test started
- **Status:** Success or failure status of the test.

TCP/UDP Throughput Up and Down graphs:

The iPerf graphs plot the throughput rate to (Up) or from (Down) the iPerf server in Mbps.

The table below each graph displays the Current, Minimum, Maximum, and Average rates.

Limit: This is the **Threshold** from the iPerf app's settings. The threshold value is also displayed on the graph as a red dotted line.

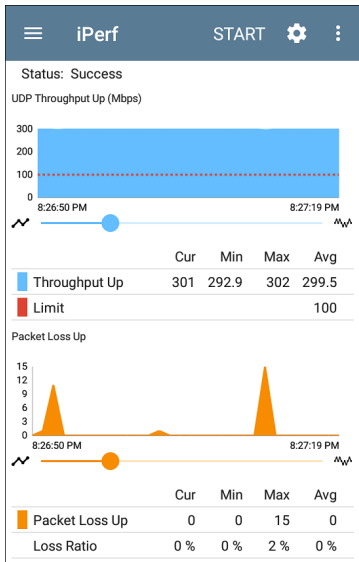

UDP Packet Loss Up and Down graphs: When running a UDP protocol test, the iPerf results also display graphs and tables of Packet Loss. Values for the number and percentage of packets lost are displayed in the table below the

graph. The Packet Loss Up graph and table do not display measurements until results are received from the iPerf server at the end of the upstream test.

Note that the Packet Loss Up number could be much less than the Packet Loss Down number.

Uploading Results to Link-Live

To send your iPerf results to the [Link-Live](#) website, tap the action overflow button  at the top right of the iPerf screen, and then tap **Upload to Link-Live**.

**Link-Live**

by NetAlly

**Iperf Result Filename**

20190619_134743

Comment

Room 302

Job Comment

Union Hall

**SAVE TO LINK-LIVE**

The [Link-Live sharing screen](#) opens and allows you to revise the auto-generated file name and attach comments to the iPerf result, which is displayed on the Results  page on Link-Live.com.

[Back to Title and Contents](#)



LANBERT™ Test App

LANBERT is a Bit Error Rate Testing application that transmits IEEE 802.3 data frames over LAN media and measures the number of frames sent, lost, and errored.



The LANBERT app runs a loopback test on fiber or copper media using:

- A second testing device to act as the loopback endpoint. This device can be an EtherScope nXG or a LinkRunner 10G.
- A switched port available with some Ethernet switches.
- A physical loopback device.

LANBERT Settings

To run a test with LANBERT, you must configure the generator settings. If you are using this unit as an active loopback device, see [Configuring LANBERT Loopback Settings](#).

Configuring LANBERT Generator Settings

To configure the LANBERT settings, open the settings  icon on the LANBERT screen or tap the Menu icon  and select **Generator Settings**.

☰ Generator Settings	
Speed	Auto
Frame Size	64 Bytes
Duration	1 minute
Grading Type	Count
Error Threshold	0 (No errors)
Loss Threshold	0 (No loss)

Tap each field to enter or revise selections as needed. Changed settings are automatically applied. When you finish configuring, tap **OK** or **Cancel** to return to the settings screen. When you finish configuring, tap the back button  to return to the LANBERT test screen.

Speed: This setting sets the link speed at which the Ethernet frames are sent to and received from the loopback destination.

- You can choose 100 Mbps, 1 Gbps, 2.5 Gbps, 5 Gbps, and 10 Gbps to match the capacity of the media you want to test. (All settings are full duplex or full duplex forced.)
- **Auto** lets the generator and loopback devices auto-negotiate the speed. (The speed may vary if there are errors or impairments.)

Frame Size: Sets the size of the Ethernet frames to be sent during the test.

- You can choose presets of 64, 128, 256, 512, 1024, 1518 bytes.

NOTE: Because the object of your bit error rate test is often to "stress" the media path with large amounts of data, choosing the minimum frame size of 64 bytes allows the maximum number of frames to be sent in the duration of the test.

- **Random** varies the frame size at random to simulate variations in real data.
- Tap the pencil icon  to open an editing screen to enter a **Custom Value** for the frame size.

Duration: Sets the time for the test. Presets range from 10 seconds up to 24 hours.

Grading Type: Sets counts or percentages to grade error or loss thresholds. Both counts and percentages are always shown on the screen.

- **Count:** counts the total number of frames encountering errors or loss of frame and sets the Error Threshold and Loss Threshold presets to numbers.
- **Percent:** calculates the percentage of frames encountering errors or loss of frame and sets the Error Threshold and Loss Threshold presets to percentages.



Error Threshold: Defines what constitutes a failed test in terms of frames that were successfully sent and received but that encountered errors that changed the frame check sequences.

- Select a value from the presets:
 - For a Grading Type of Count: 0 (no errors), 1, 10, 100, or 1000.
 - For a Grading Type of Percent: 0.0% (no errors), 0.001%, 0.01%, 0.1%, or 1%.
- **Disabled** turns off grading of errors.
- Tap the pencil icon  to open an editing screen to enter a **Custom Value** for the error threshold.

Loss Threshold: Defines what constitutes a failed test in terms of frames that were unsuccessfully sent and received.

- Select a value from the presets:
 - For a Grading Type of Count: 0 (no errors), 1, 10, 100, or 1000.
 - For a Grading Type of Percent: 0.0% (no errors), 0.001%, 0.01%, 0.1%, or 1%.
- **Disabled** turns off grading of losses.
- Tap the pencil icon  to open an editing screen to enter a **Custom Value** for the loss threshold.

Configuring LANBERT Loopback Settings

To configure this EtherScope as an active loopback device, select the LANBERT icon  from the Home screen, then tap the Menu icon  and select **Loopback Settings**. When you finish configuring, tap the back button  to return to the LANBERT test screen.

The only available setting is **Speed**.

- Match the speed to the speed you selected for the transmitting test device. You can choose 100 Mbps, 1 Gbps, 2.5 Gbps, 5 Gbps, and 10 Gbps to match the capacity of the media you want to test. (All settings are full duplex or full duplex forced.)
- **Auto** lets the EtherScope automatically negotiate the speed.

Running a LANBERT Test

Before You Begin

- Identify the cable or channel path that you want to test. (Note that LANBERT uses Ethernet frames to test LAN pathways, including copper or fiber cables. It cannot function on wide-area networks or devices that use IP addresses to route traffic.)
- Plug one end of the LAN cable into the EtherScope [Wired Test Port](#).
- Set up a loopback device at the other end of the LAN pathway to relay the received Ethernet frames back to the LANBERT generator. This device can be:
 - A physical loopback device for either copper or fiber media.
 - An Ethernet switch with a loopback feature. (Consult the manufacturer's documentation for instructions on setting up the loop.)

- A NetAlly EtherScope nXG or LinkRunner 10G with the LANBERT application running as the LANBERT Loopback. (Either device can function as the loopback relay and can collect data at the endpoint of the test.) See [LANBERT Settings](#) for instructions on setting up the loopback settings.

NOTE: The Loopback mode is designed to stop whenever the LANBERT app is not displayed on the screen. If you plan to run a long test, make sure that the loopback unit is plugged into its AC power supply and that you have turned off the sleep function (go to system Settings, tap **Display > Sleep > Never**).

Run the Test

You can set up and start either the LANBERT generator or the LANBERT loopback unit first. This procedure starts with the generator.

1. On the Tester unit, open the LANBERT application.

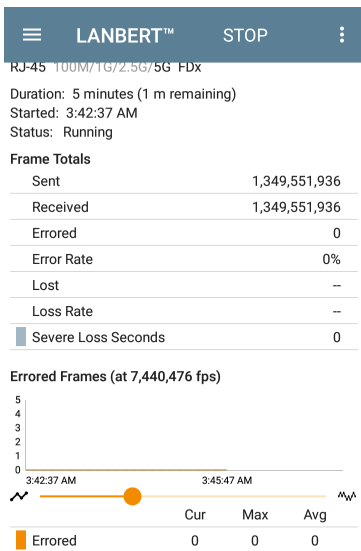
2. Tap the **START** button.

The Status shows the current activity:

- Linking: the devices are setting up a connection.
 - Waiting for loopback: the generator is waiting for a response from the loopback device.
3. On the loopback unit (if you are using an EtherScope nXG or LinkRunner 10G as the loopback device):
 - a. Open the LANBERT application.
 - b. Tap on the top left menu icon and tap on **LANBERT Loopback**.
 - c. Tap the **START** button.
 - d. The Status changes to Linking as the connection is set up with the LANBERT generator.
 4. Verify that the Status changes to Running.
 - Test status, frame information, a graph of errored frames are displayed. Multi-gigabit details are also displayed when an RJ-45 line is connected to the Wired Test Port and the link speed is 2.5G, 5G,

or 10G.

- To pan and zoom on the graphs, you can swipe, double tap, and move the slider. See the [Trending Graphs](#) topic for an overview of the graph controls.
5. Let the test run to completion. The Status shows the test result (Success or Failure) and may display additional information, such as not connecting at the fastest advertised speed.

About LANBERT Results

- The color of the LANBERT icon indicates success or failure (green for success, red for failure).
- The first line below the icon displays information about the connection including:
 - Connector type
 - Speed (in bold). Other speeds shown as grayed out values are the ones that were advertised by the link partner but not selected. See the [Wired Link Test Results](#)

for more info about advertised speeds.

- Half versus full duplex ability.

The following example below shows a successful test for an RJ-45 connector that transmitted frames at 10 Gbps at full duplex.



LANBERT Generator

RJ-45 100M/1G/2.5G/5G/10G FDx

Duration: 1 minute

Started: 10:19:05 PM

Status: Success

Frame Totals

The following example shows an unsuccessful test for an RJ-45 connector that transmitted frames at 100 Mbps at full duplex.



LANBERT Generator

RJ-45 10M/100M HDx/FDx

Duration: 10 seconds

Started: 1:45:19 PM

Status: Thresholds exceeded (4)
No frames were received (5)

Frame Totals

- SFP details are shown when using a fiber connection. These include:
 - Wavelength
 - Temperature
 - Voltage
 - Tx Bias Current
 - Tx Power
 - Rx Power
 - Rx Reference Power
 - Rx Power Difference
 - **SET REFERENCE** button (displayed only while test is running): Latches the Rx Reference Power value to the current Rx Power value.
 - **CLEAR REFERENCE** button (displayed only while test is running): Clears the Rx Reference Power value.

NOTE: The LANBERT generator and LANBERT Loopback both use the same reference power value. This

reference power is reset or cleared on a power cycle.

- Loss figures display after the test ends.
- Severe Loss Seconds occur when the LANBERT generator detects $\geq 1\%$ frame loss for one second.

Frame Totals

Sent	128,020
Received	0
Errored	0
Error Rate	--
Lost	128,020 ●
Loss Rate	100%
Severe Loss Seconds	10

Uploading Results to Link-Live

To send your LANBERT results to the [Link-Live](#) website, tap the action overflow button  at the top right of the LANBERT screen, and then tap **Upload to Link-Live** or **Upload graphs to Link-Live** (which includes the data graphs with the upload).

**Link-Live**

by NetAlly



Comment

Job Comment



SAVE TO LINK-LIVE

The [Link-Live sharing screen](#) opens. You can enter a file name (for active surveys only) and attach comments to the LANBERT results. The

results are displayed on the Results  page on Link-Live.com.



Link-Live Cloud Service

The screenshot displays the Link-Live Cloud Service interface. On the left, a sidebar shows a list of test results with columns for test name, time, and status. The main area shows detailed information for a selected test: "Shared ACK-G3-E - 550078" performed on 1/23/23 at 1:43 PM. The interface is divided into several sections:

- Test:** Shared ACK-G3-E - 550078, MAC: 00C817-550078, Device: AirCheck G3, Type: Wireless, Profile: InOffice-IPv6-Connect to LRG, Firmware: 2.2.0.43, Wired Management IP: 10.24.8.331, WiFi Management IP: 10.24.8.101.
- Link:** PHY Rate: 400 Mbps, Retry Rate: 0%, Signal: -94 dBm, Noise: -90 dBm, SAR: 56 dB, Success.
- Access Point:** 10.24.8.20, SSID: LRG, BSSID: Sonicwall108159-c884cf, 802.11 Type: a, g, n, Channel: 149, Channel Util (%): 5, Non-802.11 Util (%): 0.5.
- DHCP:** IP: 10.24.8.247, Server: 10.24.8.1, Subnet: 255.255.254.0, DHCP Total: 3417 ms, Local IP: fe80::2c0:1791:fe55:78.
- DNS:** DNS 1: 127.0.0.1.
- Gateway:** 10.24.8.1.

Link-Live Cloud Service is a free, online system for collecting, tracking, organizing, analyzing, and reporting your test results. AutoTest results are automatically uploaded once your EtherScope nXG is claimed.

The comprehensive EtherScope nXG offers more features for analyzing your network in Link-Live than previous testers. Claim your EtherScope to [Link-Live.com](https://link-live.com) to access these functions:

- Check for software updates and update your EtherScope nXG software.
- Download third-party applications from the NetAlly [App Store](#) to use on your EtherScope.
- Automatically upload [AutoTest](#) results each time you run AutoTest.
- Attach test and [Job](#) comments to Link-Live uploads, and automatically sort your results and files into folders in Link-Live.
- Upload test, discovery, and analysis results from the NetAlly apps, including Discovery, Wi-Fi, Path Analysis, AirMapper, Performance, and iPerf. See [Link-Live and Testing Apps](#) for more about uploading.

Getting Started in Link-Live Cloud Service

To start, create a user account at Link-Live.com, and sign in. You can open the Link-Live website in the EtherScope's web browser to create and manage your account.

Claiming the Unit

On Link-Live.com

1. The first time you sign in to Link-Live.com, a pop-up window appears, prompting you to claim a device.

If you already have a user account and other devices claimed to Link-Live, navigate to the **Units** page from the left side [navigation drawer](#), and then click the **Claim Unit** button  at the lower right corner of the screen .

2. Then, select the EtherScope nXG image, and follow the claiming instructions on the Link-Live website.

On the EtherScope nXG Unit

1. Open the Link-Live app. Your unit's MAC address is displayed.

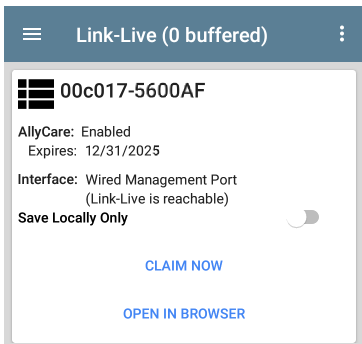

2. Tap **CLAIM NOW** on the Link-Live app screen.
3. When prompted by the instructions on the Link-Live website, enter the MAC address.

After you claim your EtherScope nXG to Link-Live, a software update may be available. If so, a notification appears in the Status Bar . Open

the [Top Notification Panel](#), and select the notification to update your unit.

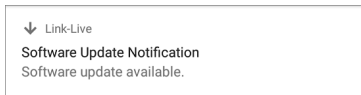

See [Updating Software](#) for more information.

After Claiming

Once your EtherScope is claimed to the Link-Live Cloud Service, it automatically uploads your AutoTest results each time you run AutoTest. You can also upload a test comment and a picture with your test results using the floating action buttons (FABs) for the [Wired Test Results](#) or [Wi-Fi Test Results](#). You can automatically sort your results into folders in Link-Live using test and [Job comments](#).

If your EtherScope is not connected to an active network, any test results, comments, or images are stored in memory (buffered) and uploaded once a connection is established.

For more information on how to use the [Link-Live.com](#) website, click or tap the

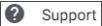
navigation menu icon  at the top left of the Link-Live.com pages, and select .

Unclaiming

You may need to unclaim your unit from Link-Live to transfer it to another user or if you no longer want to send data to Link-Live.com.

To unclaim your EtherScope from Link-Live, tap the [navigation drawer](#) icon  in the Link-Live app, tap [About](#), and then tap **UNCLAIM**.

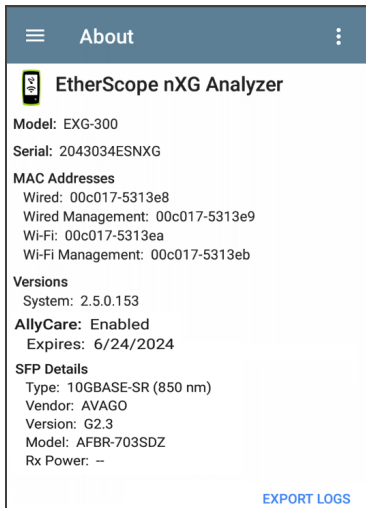

About

 **EtherScope nXG Analyzer**

Model: EXG-300

Serial: 2043034ESNXG

MAC Addresses

- Wired: 00c017-5313e8
- Wired Management: 00c017-5313e9
- Wi-Fi: 00c017-5313ea
- Wi-Fi Management: 00c017-5313eb

Versions

- System: 2.5.0.153

AllyCare: Enabled

- Expires: 6/24/2024

SFP Details

- Type: 10GBASE-SR (850 nm)
- Vendor: AVAGO
- Version: G2.3
- Model: AFBR-703SDZ
- Rx Power: --

[EXPORT LOGS](#)

[ALLYCARE CODE](#)

AllyCare Code

The AllyCare Code button appears at the bottom of the About screen next to the Export Logs button if your unit is not claimed.

[ALLYCARE CODE](#)

[EXPORT LOGS](#)

Tap **AllyCare Code** to open a dialog to enter an AllyCare Activation Code.

Private Link-Live Settings

Use these settings only when your organization has deployed a private instance of Link-Live. Consult your IT organization for setting details.

Link-Live App Features

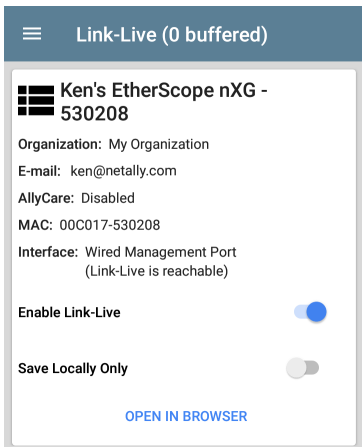

The main Link-Live app screen on your EtherScope nXG facilitates the claiming process, displays Link-Live related information, and allows you to enable or disable Link-Live.com uploads as needed.

Link-Live App Screen



The screenshot shows the Link-Live app interface. At the top, there is a dark blue header with a hamburger menu icon on the left and the text "Link-Live (0 buffered)" in white. Below the header is a white card with a grey border. The card contains the following information:

- Ken's EtherScope nXG - 530208**: A title with a black square icon to the left.
- Organization:** My Organization
- E-mail:** ken@netally.com
- AllyCare:** Disabled
- MAC:** 00C017-530208
- Interface:** Wired Management Port (Link-Live is reachable)
- Enable Link-Live:** A toggle switch that is currently turned on (blue).
- Save Locally Only:** A toggle switch that is currently turned off (grey).
- OPEN IN BROWSER:** A blue text link at the bottom of the card.

The EtherScope unit's name that displays on the Link-Live.com is shown to the right of the Link-Live icon . You can change this name on the Link-Live.com **Units**  page.

Organization is the Link-Live organization where the unit is claimed.

E-mail is the first e-mail address assigned to the unit, which receives test result notification emails.

The Organization and Email address shown here are assigned on the Link-Live.com website. The fields displayed in EtherScope's Link-Live app are informational.

AllyCare indicates the status of NetAlly's optional AllyCare services. See [NetAlly.-com/Support](https://www.netally.com/Support) for more information.

Interface shows which network interface Link-Live currently uses to post results and the network status.

The **Enable Link-Live** toggle button turns the Link-Live features on or off. If Link-Live is disabled here, the EtherScope cannot upload test results or check for software updates. The

Upload to Link-Live options do not appear in the testing apps.

Tap the **OPEN IN BROWSER** link to open Link-Live.com on the EtherScope's web browser.

The "(# buffered)" in the Link-Live screen header indicates the number of files stored in the device memory when no active network connection is available. The buffered file types are listed below the main app card.

 **Link-Live (2 buffered)**

 **Ken's EtherScope nXG - 530208**

Organization: My Organization
E-mail: ken@netally.com
AllyCare: Enabled
Expires: 12/31/2024
MAC: 00C017-530208
Interface: Wi-Fi Management Port
(Link-Live is reachable)

Enable Link-Live

Save Locally Only

[OPEN IN BROWSER](#)

Discovery Snapshot 
Apr 25, 2023 11:16:24 PM

Wi-Fi Snapshot 
Apr 25, 2023 11:16:25 PM

The buffered files displayed automatically upload to Link-Live.com once your EtherScope connects to an active network.

Saving Locally Only

If you do not want to send your results to the Link-Live website, you can still save results locally to your EtherScope as JSON files.



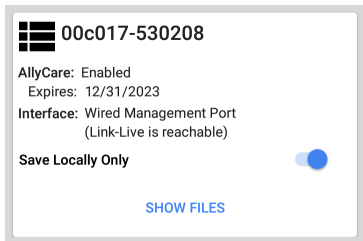

Tap the **Save Locally Only** toggle field in the Link-Live app to save the JSON files to your unit.

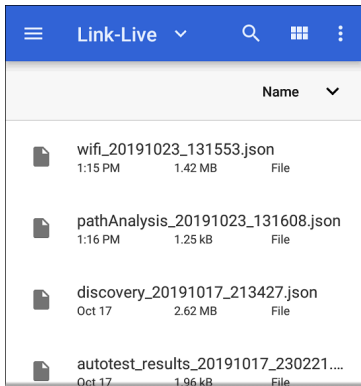

Select **SHOW FILES** to open the **Files** app. The .json files are saved in the **Downloads > TestResults** folder.



The screenshot shows the Link-Live mobile application interface. At the top is a blue header with a hamburger menu icon, the text "Link-Live" with a dropdown arrow, a search icon, a grid icon, and a vertical ellipsis icon. Below the header is a light gray bar with the text "Name" and a dropdown arrow. The main content area displays a list of four JSON files, each with a file icon, the filename, the date and time, the file size, and the file type.

	Name			
	wifi_20191023_131553.json	1:15 PM	1.42 MB	File
	pathAnalysis_20191023_131608.json	1:16 PM	1.25 kB	File
	discovery_20191017_213427.json	Oct 17	2.62 MB	File
	autotest_results_20191017_230221....	Oct 17	1.96 kB	File

See the [Managing Files](#) topic for an overview of the Files app.

You can transfer the JSON files to a PC for analysis, or you can download a JSON viewer app from the App Store  on your EtherScope.

With **Save Locally Only** enabled, options for uploading or saving to Link-Live (described in the [Link-Live and Testing Apps](#) section below) still display in the NetAlly testing apps. However, the results are saved to the internal Link-Live

storage folder, and not uploaded to Link-Live.com.

Job Comment

The [left-side navigation drawer](#) for the Link-Live app lets you enter or change the Job Comment. The **Job Comment** attaches to all test results and files uploaded to Link-Live, until you change or delete it. In contrast, other **Comments**, like those attached to [Wired](#) or [Wi-Fi](#)AutoTest results or [Discovery](#) results, are only attached to one set of test results or uploaded file.

Both comment types appear on [Link-Live sharing screens](#) like the one below:

**Link-Live**
by NetAlly

File Name
client1024rsa-new.pem

Comment
Certs

Job Comment
South Campus Wi-Fi

To enter or change the Job Comment in the Link-Live app:

1. With the Link-Live app open, tap the menu icon  or swipe right from the left side of the screen.

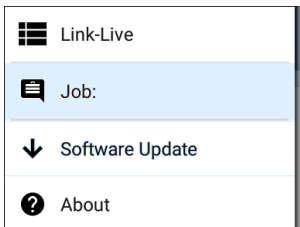

2. Tap the **Job:** field.
3. Enter a comment in the dialog box.
4. Tap **SAVE**.

Note that the **Job Comment** field appears in other Link-Live sharing screens, allowing you to change it from multiple locations on the EtherScope. No matter where you change the Job Comment, it is updated everywhere on the unit.

Software Updates





The left-side [navigation drawer](#) for the Link-Live app also lets you check for and download any available software updates. See [Updating Software](#) in the Software Management chapter.

System Notifications

Link-Live can send messages to your test unit. They are displayed in the system [Notification Panel](#).

Link-Live and Testing Apps

Once your unit is claimed, the Link-Live app works with several of the testing apps to upload test results, discovery and analysis data, comments, and images to the Link-Live website. Link-Live.com categorizes the uploads from different apps on corresponding webpages, as shown below:

LINK-LIVE WEBPAGE	APP UPLOADS
 Results	AutoTest, Performance, iPerf, and Cable Test results Images, connect logs, and other files when saved to a test result
 Uploaded Files	Captures, images, connect logs, and other file types
 Analysis	Discovery, Wi-Fi, and Path Analysis results
 AirMapper	AirMapper Heatmaps

If your unit is not claimed to [Link-Live.com](https://link-live.com) or if Link-Live is disabled on the app screen, the links and buttons for uploading to Link-Live in the testing apps do not appear.

Link-Live Sharing Screens

Save to Link-Live



UPLOAD TO LINK-LIVE

Whenever you select a button or link, like those above, to Upload, Save, or [Share](#) to Link-Live, a Link-Live sharing screen appears with the appropriate options for the data type.

For example, the Link-Live sharing screen for Discovery or Wi-Fi app data allows you to upload to the Analysis  page on Link-Live.com.

**Link-Live**

by NetAlly

**Wi-Fi Snapshot Name**

20190429_122109

Comment

Conference Room B



Job Comment

North Office



SAVE TO ANALYSIS FILES

The Link-Live sharing screen for a screenshot or other image allows you to attach it to the most recently run test result (AutoTest, Performance, iPerf, or Cable Test) (AutoTest or iPerf) on the

Results  page, or to the Uploaded Files  page on Link-Live.com.



Link-Live

by NetAlly



Comment

Conference Room B

Job Comment

North Office



SAVE TO LAST TEST RESULT



SAVE TO UPLOADED FILES

Remember, the regular **Comment** field uploads only to the current result or file, while the **Job**

Comment field uploads with all results and files until you change it.

Sharing a Text File to Link-Live

You can also select and share text by [long pressing](#) text on the unit's screen. Text files are attached to the last test results on Link-Live.com.

1. Long press a text string to select it.

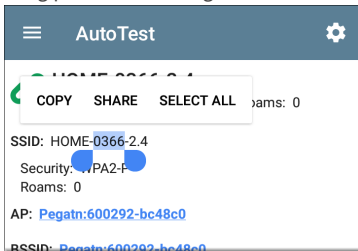

2. Tap **Select All** if needed.

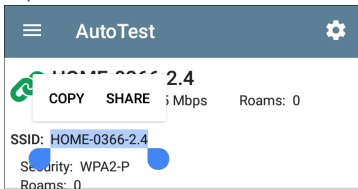

3. Tap **SHARE**.

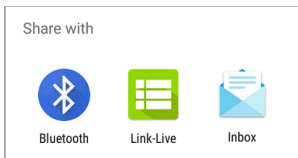

4. Select the Link-Live icon to open the [Link-Live sharing screen](#).



Link-Live
by NetAlly



File Name
20191106_155804

Comment
SSIDs

Job Comment
/Inventory

 **SAVE TO LAST TEST RESULT**

5. Enter any **comments** as needed, and then tap **SAVE TO LAST TEST RESULT**.

Basic Wired Testing With Link-Live Pairing

Link-Live allows you to add several simple wired tests by pairing a NetAlly LinkSprinter or Test Accessory with your EtherScope nXG. This ability lets you run wired tests and view the results on your unit. For example, you may wish to make sure that an AP is getting adequate PoE and basic connectivity while performing a Wi-Fi survey or running other Wi-Fi tests. The wired data is uploaded to Link-Live and then shared to your EtherScope nXG to give you more complete information.

Tests available are:

- Power Over Ethernet (PoE)
- Wired link verification
- DHCP link verification
- Gateway detection
- Link-Live access verification
- (LinkSprinter only) Wi-Fi availability

You can also view the information on Link-Live, which includes supplemental information fields.

Before You Begin

- You must have a Test Accessory iPerf Tester or a LinkSprinter Pocket Network Tester. To acquire one of these devices, contact your netally.com representative or visit: netally.com
- Read the user guide available for your product, available at: <https://www.netally.com/support/user-guides/>

Link-Live Setup

1. Log into your Link-Live account. (You can use a PC or start the Link-Live app on your EtherScope nXG and then select the **Open in Browser** option.)
2. Make sure your EtherScope nXG is [claimed](#) to Link-Live.
3. Using the same Link-Live organization to which you claimed your EtherScope nXG, claim your Test Accessory or LinkSprinter as

per the instructions in the documentation.

4. Select the **Units** option from the left-side menu. This displays your claimed devices.
5. Select your EtherScope nXG. (On a PC, you can use the filter icons at the top of the list.) This displays your device information.
6. Scroll down until you see the Pair Unit heading.
7. Tap or click on the **Pair Unit** toggle button next to the Test Accessory or LinkSprinter that you want to pair with your unit.
8. Turn off your Test Accessory or LinkSprinter and unplug its Ethernet wire connection.

Run the Paired Test and View Results

To run a paired wiring test:

1. With your Test Accessory or LinkSprinter turned off, plug the Ethernet cable connection that you want to test into the test port. (All test LEDs activate for a few seconds, and then the PoE icon LED  remains on if there is adequate power from

the connection.)

2. Wait about 90 seconds for a tests to complete. All five LEDs turn green if the tests are successful. The test results are uploaded to Link-Live and then shared with your EtherScope nXG.
3. To view the results on your EtherScope nXG:
 - a. Wait for the paired test icon  to appear on the system notification bar.
 - b. Swipe down from the top of the screen to view the notifications list.
 - c. Locate and tap on the down arrow for the notification from Link-Live that shows a new result from your Test Accessory or LinkSprinter.

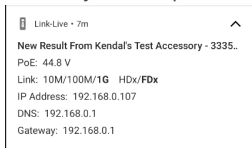

- PoE voltage is listed
- Bold fields in the Link details show actual speed and duplex.
- The IP Address is the DHCP IP.
- The DNS is the primary server (DNS 1)
- Ping times to reach google.com are not included.

NOTE: successive tests replace the data in the notice.

4. To view the results on a PC:
 - a. In Link-Live, select the **Results** option from the left-side menu. This displays your test results for all your claimed devices.
 - b. Select the results you want for the paired Test Accessory or LinkSprinter from the list. (On a PC, you can use the Search function to look for specific devices, folders, etc.) This displays the same information as the EtherScope nXG system notification described

above, but it adds additional information fields:

- Link polarity
- DHCP subnet mask
- Gateway ping time and public IP address
- Ping time for google.com
- (LinkSprinter only) Information on the nearest switch (switch name, model, IP/MAC address, port number, and type)



Cable Test App

EtherScope nXG's Cable Test can help you determine cable length and fault status, verify wiremapping of patch and structured cabling, and locate cable connections using toning. The cable testing port is the RJ-45 port on the left side of the EtherScope unit. Connect a cable to this port for testing and tracing with the tone function.

Cable Test Settings

The Cable Test app has limited settings. Tap the navigation menu icon  or swipe from the left-side drawer to open the Cable Test Settings.

Flash Port

Tap this setting choice to activate the Flash Port function, which flashes port LEDs to help you locate cables and ports. See [Running Cable Test](#) for instructions on using this function.

Distance Unit

The **Distance Unit** setting is contained in the [General Settings](#) menu. The setting designates Feet or Meters.

1. To access General Settings, tap the menu  icon on the Cable Test app screen, and select **General Settings**.

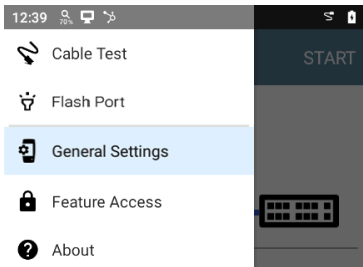

2. Scroll to the bottom of the Settings list under the **Preferences** heading.
3. Tap the **Distance Unit** field, and select either **Feet** or **Meters** as needed, and then tap **OK**.
4. Tap the Back button  at the bottom of the screen to return to the Cable Test screen.

Running Cable Test

The Cable Test app has general tests for cables as well as a [toning function](#) and a [flash port function](#) to help you trace cables and ports. You can also [upload your results to Link-Live](#).

General Cable Tests

Refer to EtherScope nXG's [Buttons and Ports](#) as needed.

- With an [open or unterminated](#) cable connected to the RJ-45 cable test port (left side of the unit), you can measure length, identify shorts and splits, and locate opens.
- Using a cable terminated with a [WireView Cable ID accessory](#), you can measure cable length and identify shorts, opens, split pairs, crossover cables, normal or negative pair polarity, and shielded cables.
- EtherScope nXG cannot perform a cable test on a cable that is connected to a switch; however, you can still use the [toning function](#) to trace the cable to the connected port.

- Additionally, you cannot run a cable test or use the toning feature if the unit detects voltage on the connected cable. The lightning bolt icon on the Cable Test screen indicates detected voltage.

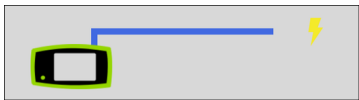

To start the cable test, tap **START** at the top right of the Cable Test app screen.

Open Cable TDR Testing

EtherScope nXG can measure the length of a cable and detect some faults by measuring the electrical reflections of the cable using Time Domain Reflectometry (TDR). Connect an open cable (unterminated) into the RJ-45 port on the left side of the EtherScope unit to measure its length and view any shorts, opens, or splits.

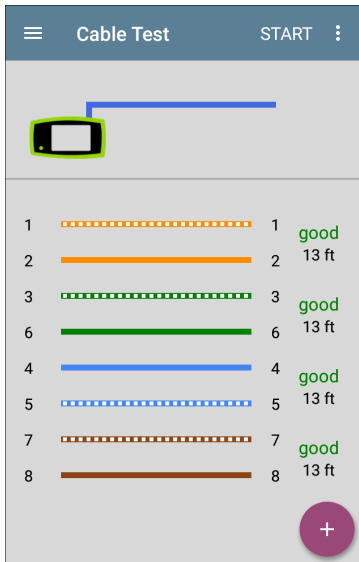

When a cable has no detected faults, "good" is shown next to each pair above the length measurement. Cable tests that detect a "split" or "open" in the cable also display the corresponding words.

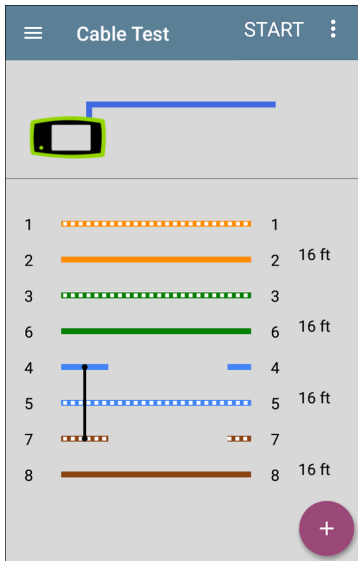

This unterminated cable test image shows a shorted cable between pins 4 and 7.

Terminated WireView Testing

Using a WireView accessory provides more detailed, per-wire results. A WireView #1 is included with your EtherScope nXG. Additional WireViews 2-6 are available for purchase.

To run a terminated cable test, connect the left side RJ-45 port to a cable terminated with an external WireView Cable ID accessory.

The terminated cable test screen displays the number of the WireView attached, unless a cable fault prevents the EtherScope from detecting the WireView.

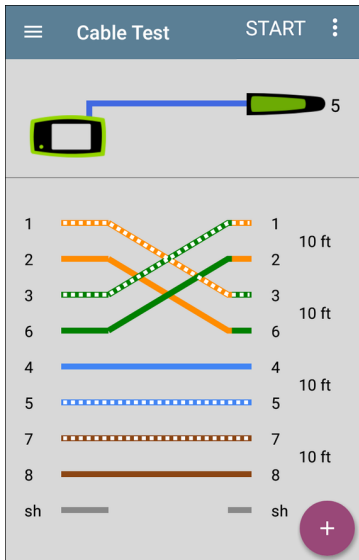

The image above indicates a crossover between pairs 1, 2 and 3, 6 and a WireView accessory number 5.

The last row of WireView results indicates whether the cable is shielded: an unbroken line between **sh** means a shielded cable is detected.



Toning Function

You can also trace a cable using a Fluke Networks IntelliTone™ Probe^{*}, an analog probe, or the Tone function.

1. Connect a cable into the left side RJ-45 port.
2. Tap the floating action button (FAB)  to display the tone menu:

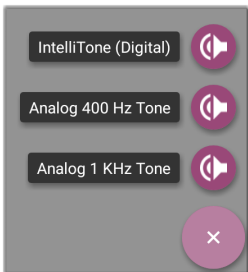

* IntelliTone is a trademark of Fluke Networks.

3. Select a Tone option from the menu. The EtherScope nXG emits the tone through the cable, and the probe detects it, allowing you to trace the wire or locate it in a switch closet or rack.

Flash Port Function

Flash Port gives you the ability to make the LEDs blink on your unit's RJ-45 test port and on the switch to which your unit is connected. This helps make the connected port easier to locate on the switch.

To use the flash port feature:

1. Connect the left side RJ-45 port to an active network cable.
2. Tap the navigation menu icon  or swipe from the left-side drawer to open the Cable Test Settings.

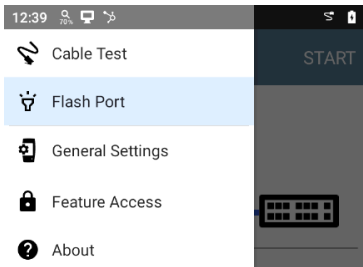

3. Tap **Flash Port** to open the Flash Port screen. If the connection to the switch is good, a blue line connects a test unit icon to a switch icon.



Flash Port



Slow

Fast

- Use the slider to set the rate of the flash.

TIP: Some port LEDs may have trouble flashing at a very fast rate. Setting a rate slower than the maximum may work better.
- Tap the **Start** button. When the flash function begins, a green circle appears over the switch icon and flashes at the rate you set with the slider. The green circle, the LEDs on the top RJ-45 port of your test unit,



and the LEDs for the connected port on the switch all blink in unison.

Flash Port



6. When you finish using the Flash Port function, tap the **Stop** button.

Uploading Results to Link-Live

Tap the action overflow icon  at the top right of the Cable Test screen, and select **Upload to Link-Live** to send the current Cable Test result to the Results page  on [Link-Live.com](https://link-live.com).

See the [Link-Live](#) for more information.



Switch App

The Switch application displays a summary of AutoTest's Wired Profile results from the Link, PoE, and Nearest Switch result screens. This gives you a fast way to display information about how your EtherScope nXG is connected.



NOTE: This application is available on the [Apps screen](#), not the default Home screen. You can open Switch from the Apps screen or tap and hold the icon to move it to your Home screen.

Running Switch

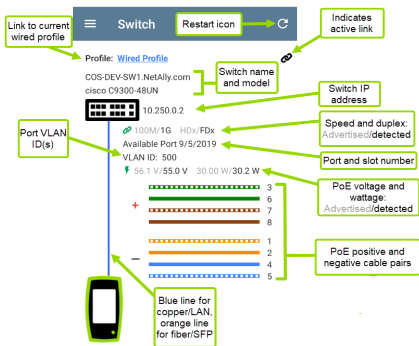
Before running switch, use AutoTest to start a [wired profile](#) so that Switch has information when you need it. To run Switch, simply tap the Switch app icon. This opens the main Switch screen.



The main Switch screen has only a few controls and no settings.



- Tap the Restart icon  to update the switch information. The app displays results from the nearest switch for the wired AutoTest profile that was last run or is currently running.
 - A black Link icon  in the upper right corner of the screen appears when the tester is actively linked.
 - A "no cable" icon displays if no connection is available:



NOTE: Displayed results are retained even after the cable is disconnected. Just tap Restart  to capture and displays the newest information from the switch.

- To open the AutoTest profile, tap the Profile link:

Profile: [Wired Profile](#)

For detailed information, tap the AutoTest cards that display the Link icon , the PoE icon , or the Switch icon .

Specifications and Compliance

This chapter contains device specifications and required compliance information.

EXG-200 Specifications

General

Dimensions	4.05 in x 7.67 in x 2.16 in (10.3 cm x 19.5 cm x 5.5 cm)
Weight	1.677 lbs (0.76 kg)
Battery	Rechargeable lithium-ion battery pack (7.2 V, 6.4 Ah, 46 Wh)
Battery Run Duration, Charge Time	Typical duration: 3-4 hours with all hardware powered on 8+ hours if wired test port is disabled Typical charge time: 2-4 hours
Display	5.0-inch color LCD with capacitive touchscreen (720 x 1280 pixels)
Host Interfaces	RJ-45 Cable Test and Management Port USB Type-A Port USB Type-C On-the-Go Port
SD Card Port	Supports Micro SD card storage
Memory	Approximately 8 GB available for storing test results and user applications

Charging	USB Type-C 45-W adapter: AC Input Power 100-240 V, 50-60 Hz; DC Output Power 15 V (3 A)
Media Access	Copper: 10M/100M/1G/2.5G/5G/10G Fiber SFP Adapters: 1G/10GBASE-X
Supported IEEE Standards	Wired: 802.3/ab/ae/an/bz/i/u/z Wi-Fi: 802.11a/b/g/n/ac PoE: 802.3af/at/bt, Class 0-8 and UPOE
Cable Test	Pair lengths, opens, shorts, splits, crossed, straight through, and WireView ID
Tone Generator	Digital tone: [455 KHz]; Analog tones: [400 Hz, 1 KHz]
LEDs	2 LEDs (Activity and Link Indicators)

Wireless

EtherScope nXG has two internal Wi-Fi Radios:

Wi-Fi Testing – 4x4 Dual-band 802.11ac Wave 2 wireless radio

System Wi-Fi, Bluetooth, and Management – 1x1 Dual-band 802.11ac Wave 2 + Bluetooth 5.0 and BLE wireless radio

Both are IEEE 802.11a/b/g/n/ac compliant.

4x4 Wi-Fi Radio for Testing

Applicant's Name	NetAlly
Model Number	BCM43465
Manufacturer	LITE-ON Technology Corporation
Manufacture Date	2017
Country of Origin	Taiwan
Security	64/128-Bit WEP Key, WPA, WPA2, 802.1X (TKIP, AES)
Regulatory Domain	World Mode
Antenna Gain	1.1 dBi peak in the 2.4-GHz band; 3.2 dBi peak in the 5-GHz band

Data Rates

- **802.11a:** 6, 9, 12, 18, 24, 36, 48, 54 Mbps
- **802.11b:** 1, 2, 5.5, 11 Mbps
- **802.11g:** 6, 9, 12, 18, 24, 36, 48, 54 Mbps
- **802.11n 20 MHz:** 7.2, 14.4, 21.7, 28.9, 43.3, 57.8, 65, 72.2, 86.7 Mbps
- **802.11n 40 MHz:** 15, 30, 45, 60, 90, 120, 135, 150 Mbps
- **802.11ac 20 MHz:** 7.2, 14.4, 21.7, 28.9, 43.3, 57.8, 65, 72.2, 86.7 Mbps
- **802.11ac 40 MHz:** 15, 30, 45, 60, 90, 120, 135, 150, 180, 200 Mbps
- **802.11ac 80 MHz:** 32.5, 65, 97.5, 130, 195, 260, 292.5, 325, 390, 433 Mbps
- **802.11ac 160 MHz:** 65, 130, 260, 390, 520, 585, 650, 780, 867 Mbps

Operating Frequencies

The EtherScope nXG receives on all of the frequencies in every country, but transmits only on the frequencies and channels allowed in the country.

These are the center frequencies of the channels that the Wi-Fi radio supports.

- **2.4-GHz band:** 2.412 – 2.484 GHz (channels 1 through 14)
- **5-GHz band:** 5.150 – 5.825 GHz (channels 34, 36, 38, 40, 42, 44, 46, 48, 52, 56, 60, 64, 100, 104, 108, 112, 116, 120, 124, 128, 132, 136, 140, 144, 149, 153, 157, 161, 165)

Modulation

- **802.11b:** DBPSK (1 Mbps), DQPSK (2 Mbps), CCK (5.5 and 11 Mbps)
- **802.11g/n:** DBPSK, DQPSK, OFDM, BPSK, QPSK, 16QAM, 64QAM, 256QAM, 1024QAM (proprietary)

Receive Sensitivity (Minimum)

- **6 Mbps:** -90 dBm
- **54 Mbps:** -71 dBm
- **802.11n 20 MHz:** -89 dBm (MSC 0/8)
- **802.11n 40 MHz:** -86 dBm (MSC 0/8)
- **VHT20 MCS 8:** -63 dBm
- **VHT40 MCS 9:** -60 dBm
- **VHT80 MCS 9:** -57 dBm

System 1x1 Wi-Fi/Bluetooth Adapter for Management

Applicant's Name	NetAlly
Model	Bluebean-A
Manufacturer	8devices
Manufacture Date	2019
Country of Origin	United States
Security	64/128-Bit WEP Key, WPA, WPA2, 802.1X (TKIP, AES)
Regulatory Domain	World Mode
Antenna Peak Gain	+2.27 dBi in the 2.4-GHz band +5.18 dBi in the 5-GHz band

Data Rates

- **802.11a:** 6, 9, 12, 18, 24, 36, 48, 54 Mbps
- **802.11b:** 1, 2, 5.5, 11 Mbps
- **802.11g:** 6, 9, 12, 18, 24, 36, 48, 54 Mbps
- **802.11n 20 MHz:** 7.2, 14.4, 21.7, 28.9, 43.3, 57.8, 65, 72.2, 86.7 Mbps
- **802.11n 40 MHz:** 15, 30, 45, 60, 90, 120, 135, 150 Mbps
- **802.11ac 20 MHz:** 7.2, 14.4, 21.7, 28.9, 43.3, 57.8, 65, 72.2, 86.7 Mbps
- **802.11ac 40 MHz:** 15, 30, 45, 60, 90, 120, 135, 150, 180, 200 Mbps
- **802.11ac 80 MHz:** 32.5, 65, 97.5, 130, 195, 260, 292.5, 325, 390, 433.3 Mbps

Operating Frequencies

The EtherScope nXG receives on all of the frequencies in every country, but transmits only on the frequencies and channels allowed in the country.

These are the center frequencies of the channels that the Wi-Fi radio supports.

- **2.4-GHz band:** 2.412 – 2.484 GHz (channels 1 through 14)
- **5-GHz band:** 5.150 – 5.825 GHz (channels 34, 36, 38, 40, 42, 44, 46, 48, 52, 56, 60, 64, 100, 104, 108, 112, 116, 120, 124, 128, 132, 136, 140, 144, 149, 153, 157, 161, 165)

Modulation

- **802.11a:** BPSK (6 and 9 Mbps), QPSK (12 and 18 Mbps), 16 QAM (24 and 36 Mbps), 64 QAM (48 and 54 Mbps), OFDM
- **802.11n/ac:** BPSK (MCS0), QPSK (MCS1 and MCS2), 16 QAM (MCS3 and MCS4), 64 QAM (MCS5, 6, and 7), OFDM
- **802.11ac:** 256 QAM (MCS8 and MCS9), OFDM
- **802.11b:** DBPSK, BPSK (1 and 2 Mbps), QPSK (2 Mbps), CCK (5.5 and 11 Mbps)
- **802.11g:** BPSK (6 and 9 Mbps), QPSK (12 and 18 Mbps), 16 QAM (24 and 36 Mbps), 64 QAM (48 and 54 Mbps), OFDM

Bluetooth v5 and BLE

- **Frequency Range:** 2.402 – 2.480 GHz
- **Max TX power:** 14 dBm (4 dBm BLE)

External Directional Antenna Accessory

Minimum gain: 5.0-dBi peak in the 2.4-GHz band and 7.0-dBi peak in the 5-GHz band

Reverse-polarity SMA plug

Antenna frequency range: 2.4 – 2.5 and 4.9 – 5.9 GHz

External antenna port is receive-only (no transmit).

Environmental Specifications

Operating Temperature	32°F to 113°F (0°C to +45°C) NOTE: The battery will not charge if the internal temperature of the unit is above 113°F (45°C).
Operating relative humidity (% RH without condensation)	90% (50°F to 95°F; 10°C to 35°C) 75% (95°F to 113°F; 35°C to 45°C)
Storage Temperature	-4°F to 140°F (-20°C to +60°C)
Shock and vibration	Meets the requirements of MIL-PRF-28800F for Class 3 Equipment
Safety	IEC 61010-1:2010: Pollution degree 2
Altitude	Operating: 4,000 m; Storage: 12,000 m

EXG-200 Certifications and Compliance

⚠ CAUTION: Changes or modifications not expressly approved by the party responsible for compliance could void the user's authority to operate the equipment.



Conforms to relevant European Union directives.



Conforms to relevant Australian Safety and EMC standards.



Complies with 47 CFR Part 15 requirements of the U.S. Federal Communications Commission.



Listed by the Canadian Standards Association.

Industry Canada Class A emission compliance

statement: This Class A digital apparatus complies with Canadian ICES-003. Avis de conformité à la réglementation d'Industrie Canada Cet appareil numérique de la classe A est conforme à la norme NMB-003 du Canada.

This device is not capable of transmitting in 5600-5650 MHz. This restriction is for the protection of Environment Canada's weather radars operating in this band.

U-NII devices operating in the 5.25-5.35 GHz and 5.47-5.725 GHz band, without radar detection are restricted to use indoors.

**Contains
FCC IDs**

WA7-43465, WA7-9377

**Contains IC
IDs**

6627C-43465, 6627C-9377

This device complies with part 15 of the FCC Rules. Operation is subject to the following two conditions: (1) This device may not cause harmful interference, and (2) this device must accept any interference received, including interference that may cause undesired operation.

This device contains license-exempt transmitter(s)/receiver(s) that comply with Innovation, Science and Economic Development Canada's licence-exempt RSS(s).

L'émetteur/récepteur exempt de licence contenu dans le présent appareil est conforme aux CNR d'Innovation, Sciences et Développement économique Canada applicables aux appareils radio exempts de licence.

L'exploitation est autorisée aux deux conditions suivantes : 1. L'appareil ne doit pas produire de brouillage; 2. L'appareil doit accepter tout brouillage radioélectrique subi, même si le brouillage est susceptible d'en compromettre le fonctionnement.

Absorption Rate (SAR) information: This device meets the government's requirements for exposure to radio waves. The guidelines are based on standards that were developed by independent scientific organizations through periodic and thorough evaluation of scientific studies. The standards include a substantial safety margin designed to assure the safety of all persons regardless of age or health.

FCC RF Exposure Information and Statement: The SAR limit of USA (FCC) is 1.6 W/kg averaged over one gram of tissue. This device was tested for typical body-worn operations with the back of the handset kept 0 cm from the body. To maintain compliance with FCC RF exposure requirements, use accessories that maintain a 0 cm separation distance between the user's body and the back of the handset. The use of belt clips, holsters and similar accessories should not contain metallic components in its assembly. The use of accessories that do not satisfy these requirements may not comply with FCC RF exposure requirements, and should be avoided.

Body-worn Operation: This device was tested for typical body-worn operations. To comply with RF exposure requirements, a minimum separation distance of 0 cm must be maintained between the user's body and the handset, including the antenna. Third-party belt-clips, holsters, and similar accessories used by this device should not contain any metallic components. Body-worn accessories that do not meet these requirements may not comply with RF exposure requirements and should be avoided. Use only the supplied or an approved antenna.

EMC

IEC 61326-1:2013: Basic Electromagnetic Environment; CISPR 11: Group 1, Class A

Group 1: Equipment has intentionally generated and/or uses conductively-coupled radio frequency energy that is necessary for the internal function of the equipment itself.

Class A: Equipment is suitable for use in all establishments other than domestic and those directly connected to a low-voltage power supply network that supplies buildings used for domestic purposes. There may be potential difficulties in ensuring electromagnetic compatibility in other environments due to conducted and radiated disturbances.

EU Compliance

This device complies with the following EU Directives: Directives 2014/53/EU, 2014/35/EU, and 2014/30/EU.

This device complies with RF specifications when the device is used at 0 mm from your body. Maximum measured SAR was 2.21 W/kg body; EU limit is 4.0 W/kg.

Accessory Information:

Adapter Model No.: FSP045-A1BR

Input: AC 100-240 V, 50/60 Hz 1.2 A

Output: DC 15 V, 3 A

Battery: 3250 mAh, 7.2 V 6.4 Ah

Wi-Fi: 2412 MHz-2472 MHz, 5180 MHz-5240 MHz, 5725 MHz - 5875 MHz

Bluetooth/BLE: 2402 MHz - 2480 MHz

เครื่องโทรคมนาคมและอุปกรณ์นี้ มีความสอดคล้องตามข้อกำหนดของ กสทช. (This telecommunication equipment conforms to the requirements of NBTC.)

EXG-300 Specifications

General

Dimensions	4.05 in x 7.67 in x 2.16 in (10.3 cm x 19.5 cm x 5.5 cm)
Weight	1.677 lbs (0.76 kg)
Battery	Rechargeable lithium-ion battery pack (7.2 V, 6.4 Ah, 46 Wh)
Battery Run Duration, Charge Time	Typical duration: 3-4 hours with all hardware powered on 8+ hours if wired test port is disabled Typical charge time: 2-4 hours
Display	5.0-inch color LCD with capacitive touchscreen (720 x 1280 pixels)
Host Interfaces	RJ-45 Cable Test and Management Port USB Type-A Port USB Type-C On-the-Go Port
SD Card Port	Supports Micro SD card storage
Memory	Approximately 8 GB available for storing test results and user applications

Charging Adapter	USB Type-C 45-W adapter: AC Input Power 100-240 V, 50-60 Hz; DC Output Power 15 V (3 A)
Supported IEEE Standards	Wired: 802.3/ab/ae/an/bz/i/u/z Wi-Fi: 802.11ax/ac/a/b/g/n PoE: 802.3af/at/bt, Class 0-8 and UPOE
Cable Test	Pair lengths, opens shorts, splits, crossed, straight through, and WireView ID
LEDs	2 LEDs (Activity and Link Indicators)

Wireless

EtherScope nXG has two internal Wi-Fi Radios:

- **Wi-Fi Testing** – Wi-Fi 6/6E 2x2 MU-MIMO wireless radio, IEEE 802.11 a/b/g/n/ac/ax compliant.
- **System Wi-Fi, Bluetooth, and Management** – 1x1 Dual-band, IEEE 802.11 a/b/g/n/ac compliant, Wave 2 + Bluetooth 5.0 and BLE wireless radio

WiFi 6/6E 2x2 MU-MIMO Radio for Testing

Applicant's Name	NetAlly
Model Number	WNFQ-268AXI(BT)
Manufacturer	SparkLAN Communications, Inc.
Manufacture Date	2021
Country of Origin	Taiwan
Security	64/128-bits WEP, WPA, WPA2, WPA3, 802.1x
Regulatory Domain	EXG-300 United States EXG-300C China EXG-300E World Mode
Internal Antenna Peak Gain (dBi, YZ plane)	+2.0 @ 2400-2500 GHz) +1.5 @ 4900-5850 GHz) +2.7 @ 5850-7200 GHz)

Data Rates

- **802.11a/g:** 54 Mbps
- **802.11ac:** MCS0~9
- **802.11ax:** HE0~11
- **802.11b:** 11 Mbps

- **802.11n:** MCS0~15
- **Bluetooth:** 1 Mbps, 2 Mbps, and up to 3 Mbps

Operating Frequencies (Test Wi-Fi, 3 Bands)

EXG-300/EXG-300E: The test unit receives on all of the frequencies in every country, but transmits only on the frequencies and channels allowed in the country.

EXG-300C: The test unit receives and transmits only on the frequencies and channels allowed in the country.

Operating Frequencies (Management Wi-Fi, 2 Bands)

The test unit receives and transmits only on the frequencies and channels allowed in the country.

Modulation

Wi-Fi:

- **802.11a:** OFDM (BPSK, QPSK, 16-QAM, 64-QAM)

- **802.11ac:** OFDM (BPSK, QPSK, 16-QAM, 64-QAM, 256-QAM)
- **802.11ax:** OFDMA (BPSK, QPSK, 16-QAM, 64-QAM, 256-QAM, 1024-QAM)
- **802.11b:** DSSS (DBPSK, DQPSK, CCK)
- **802.11g:** OFDM (BPSK, QPSK, 16-QAM, 64-QAM)
- **802.11n:** OFDM (BPSK, QPSK, 16-QAM, 64-QAM)

Bluetooth:

- **Header:** GFSK
- **Payload 2M:** $\pi/4$ -DQPSK
- **Payload 3M:** 8-DPSK

Receive Sensitivity (Minimum)

- 802.11b, 11 Mbps: -90 dBm
- 802.11g, 54 Mbps: -76.5 dBm
- 802.11n / 2.4 GHz, HT20, MCS7: -76 dBm
- 802.11n / 2.4 GHz, HT40, MCS7: -73 dBm
- 802.11a 54 Mbps: -97.5 dBm
- 802.11n / 5 GHz, HT20, MCS7: -76.5 dBm
- 802.11n / 5 GHz, HT40, MCS7: -76.5 dBm
- 802.11ac, VHT80, MCS9: -62 dBm

- 802.11ac, VHT160, MCS9: -62 dBm
- 802.11ax / 2.4 GHz, HE40, MCS 9: -67 dBm
- 802.11ax / 5 GHz, HE20, HE11: -64.5 dBm
- 802.11ax / 2.4 GHz, HE40, HE11: -63.5 dBm
- 802.11ax / 2.4 GHz, HE80, HE11: -59 dBm
- 802.11ax / 2.4 GHz, HE160, HE11: -56.5 dBm
- 802.11ax / 6 GHz, HE20, HE11: -63 dBm
- 802.11ax / 6 GHz, HE40, HE11: -61 dBm
- 802.11ax / 6 GHz, HE80, HE11: -58 dBm
- 802.11ax / 6 GHz, HE160, HE11: -55 dBm
- Bluetooth, 3 Mbps: 0.1% BR, BER at -70 dBm

System 1x1 Wi-Fi/Bluetooth Adapter for Management

Applicant's Name	NetAlly
Model	Bluebean-A
Manufacturer	8devices
Manufacture Date	2019
Country of Origin	United States
Security	64/128-Bit WEP Key, WPA, WPA2, 802.1X (TKIP, AES)
Regulatory Domain	EXG-300 United States EXG-300C China EXG-300E World Mode
Antenna Peak Gain	+2.27 dBi in the 2.4-GHz band +5.18 dBi in the 5-GHz band

Data Rates

- **802.11a:** 6, 9, 12, 18, 24, 36, 48, 54 Mbps
- **802.11b:** 1, 2, 5.5, 11 Mbps
- **802.11g:** 6, 9, 12, 18, 24, 36, 48, 54 Mbps
- **802.11n 20 MHz:** 7.2, 14.4, 21.7, 28.9, 43.3, 57.8, 65, 72.2, 86.7 Mbps
- **802.11n 40 MHz:** 15, 30, 45, 60, 90, 120, 135, 150 Mbps

- **802.11ac 20 MHz:** 7.2, 14.4, 21.7, 28.9, 43.3, 57.8, 65, 72.2, 86.7 Mbps
- **802.11ac 40 MHz:** 15, 30, 45, 60, 90, 120, 135, 150, 180, 200 Mbps
- **802.11ac 80 MHz:** 32.5, 65, 97.5, 130, 195, 260, 292.5, 325, 390, 433.3 Mbps

Operating Frequencies

The EtherScope nXG receives on all of the frequencies in every country, but transmits only on the frequencies and channels allowed in the country or if the unit detects the AP 802.11d domain.

The following channels are supported in each band:

- **2.4-GHz band:** 2.412 – 2.484 GHz (channels 1 through 14)
- **5-GHz band:** 5.150 – 5.825 GHz (channels 34, 36, 38, 40, 42, 44, 46, 48, 52, 56, 60, 64, 100, 104, 108, 112, 116, 120, 124, 128, 132, 136, 140, 144, 149, 153, 157, 161, 165)
- **6-GHz band:**
 - 5.925 – 6.425 GHz (Channels 1E, 5E, 9E, 13E, 17E, 21E, 25E, 29E, 33E, 37E, 41E, 45E, 49E, 53E, 57E, 61E, 65E, 69E, 73E, 77E, 81E, 85E, 89E, 93E)

- 6.425 – 6.525 GHz (Channels 97E, 101E, 105E, 109E, 113E)
- 6.525 – 6.825 GHz (Channels 117E, 121E, 125E, 129E, 133E, 137E, 141E, 145E, 149E, 153E, 157E, 161E, 165E, 169E, 173E, 177E, 181E, 185E)
- 6.825 – 7.125 GHz (Channels 189E, 193E, 197E, 201E, 205E, 209E, 213E, 217E, 221E, 225E, 229E, 233E)

Modulation

- **802.11a:** BPSK (6 and 9 Mbps), QPSK (12 and 18 Mbps), 16 QAM (24 and 36 Mbps), 64 QAM (48 and 54 Mbps), OFDM
- **802.11n/ac:** BPSK (MCS0), QPSK (MCS1 and MCS2), 16 QAM (MCS3 and MCS4), 64 QAM (MCS5, 6, and 7), OFDM
- **802.11ac:** 256 QAM (MCS8 and MCS9), OFDM
- **802.11b:** DBPSK, BPSK (1 and 2 Mbps), QPSK (2 Mbps), CCK (5.5 and 11 Mbps)
- **802.11g:** BPSK (6 and 9 Mbps), QPSK (12 and 18 Mbps), 16 QAM (24 and 36 Mbps), 64 QAM (48 and 54 Mbps), OFDM

Bluetooth v5 and BLE

- **Frequency Range:** 2.402 – 2.480 GHz
- **Max TX power:** 14 dBm (4 dBm BLE)

External Directional Antenna Accessory

- Antenna type: patch directional
- Average gain: 2.4 GHz: +6.4 dBi, 5 GHz: +8.9 dBi, 6 GHz: +8.6 dBi
- RP-SMA connector
- Frequency range: 2400-2500, 4900-5925, 6000-7125 (MHz)
- Receive only antenna (no transmit allowed)

Environmental Specifications

Operating Temperature	32°F to 113°F (0°C to +45°C) NOTE: The battery will not charge if the internal temperature of the unit is above 113°F (45°C).
Operating relative humidity (% RH without condensation)	90% (50°F to 95°F; 10°C to 35°C) 75% (95°F to 113°F; 35°C to 45°C)
Storage Temperature	-4°F to 140°F (-20°C to +60°C)

Shock and vibration

Meets the requirements of MIL-PRF-28800F for Class 3 Equipment

Safety

IEC 61010-1:2010: Pollution degree 2

Altitude

Operating: 4,000 m; Storage: 12,000 m

EXG-300 Certifications and Compliance

CAUTION: Changes or modifications not expressly approved by the party responsible for compliance could void the user's authority to operate the equipment.



Complies with 47 CFR Part 15 requirements of the U.S. Federal Communications Commission.



Conforms to relevant Australian Safety and EMC standards.



Listed by the Canadian Standards Association.



Conforms to relevant European Union directives.



Complies with United Kingdom and European Economic Area radiation

exposure limits.

Also includes Japan Indoor Use Statement and
Taiwan Regulatory Statement



FCC Notices

Contains FCC IDs

RYK-WNFQ268AXB
T, WA7-9377

Contains IC IDs

6158A-WNFQ268AXB
T, 6627C-9377

This equipment has been tested and found to comply with the limits for a class B digital device, pursuant to part 15 of the FCC Rules. These limits are designed to provide reasonable protection against harmful interference in a residential installation. This equipment generates, uses and can radiate radio frequency energy and if not installed and used in accordance with the instructions, may cause harmful interference to radio communications. However, there is no guarantee that interference will not occur in a particular installation. If this equipment does cause

harmful interference to radio or television reception, which can be determined by turning the equipment off and on, the user is encouraged to try to correct the interference by one or more of the following measures:

- Reorient or relocate the receiving antenna.
- Increase the separation between the equipment and receiver.
- Connect the equipment into an outlet on a circuit different from that to which the receiver is connected.
- Consult the dealer or an experienced radio/TV technician for help.

Caution: Any changes or modifications made to the equipment without the approval of manufacturer could void the user's authority to operate this equipment.

The device is for indoor use. This equipment may only be operated indoors. Operation outdoors is in violation of 47 U.S.C. 301 and could subject the operator to serious legal penalties.

The operation of this device is prohibited on oil platforms, cars, trains, boats, and aircraft, except that operation of this device is permitted in large aircraft while flying above 10,000 feet. Operation of transmitters in the 5.925-7.125 GHz band is prohibited for control of or communications with unmanned aircraft systems.

Warning: FCC Radiation Exposure Statement: This equipment complies with FCC radiation exposure limits set forth for an uncontrolled environment. This equipment should be installed and operated with a minimum distance of 25 cm between the radiator and your body.



Australian IEC 61326-1:2013: Basic Electromagnetic Environment; CISPR 11: Group 1, Class A

Group 1: Equipment has intentionally generated and/or uses conductively-coupled radio frequency energy that is necessary for

the internal function of the equipment itself.

Class A: Equipment is suitable for use in all establishments other than domestic and those directly connected to a low-voltage power supply network that supplies buildings used for domestic purposes. There may be potential difficulties in ensuring electromagnetic compatibility in other environments due to conducted and radiated disturbances.



Innovation, Science and
Economic Development Canada

Innovation, Sciences et
Développement économique Canada

Warning: For indoor use only. Pour une utilisation en intérieur uniquement. This device complies with Industry Canada license-exempt RSS standard(s). Operation is subject to the following two conditions: (1) this device may not cause interference, and (2) this device must accept any interference, including interference that may cause undesired operation of the device.

Le présent appareil est conforme aux CNR d'Industrie Canada applicables aux appareils radio exempts de licence. L'exploitation est

autorisée aux deux conditions suivantes: (1) le dispositif ne doit pas produire de brouillage préjudiciable, et (2) ce dispositif doit accepter tout brouillage reçu, y compris un brouillage brouillage susceptible de provoquer un fonctionnement indésirable.

Warning: IC Radiation Exposure Statement:

This equipment complies with RSS-102 radiation exposure limits set forth for an uncontrolled environment. This equipment should be installed and operated with minimum distance 27 cm between the radiator & your body.

Avertissement: Cet équipement est conforme aux limites d'exposition aux rayonnements RSS-102 établies pour un environnement non contrôlé. Cet équipement doit être installé et utilisé avec une distance minimale de 20 cm entre le radiateur et votre corps.

Caution: The device for operation in the band 5150-5530 MHz is only for indoor use to reduce the potential for harmful interference to co-channel mobile satellite systems.

Avertissement: les dispositifs fonctionnant dans la bande 5150-5530 MHz sont réservés uniquement pour une utilisation à l'intérieur afin de réduire les risques de brouillage préjudiciable aux systèmes de satellites mobiles utilisant les mêmes canaux.

This radio transmitter has been approved by Innovation, Science and Economic Development Canada to operate with the antenna types listed in the SparkLAN WNFQ-268AXI(BT) Datasheet, with the maximum permissible gain indicated. Antenna types not included in this list that have a gain greater than the maximum gain indicated for any type listed are strictly prohibited for use with this device.

Cet émetteur radio a été approuvé par Innovation, Sciences et Développement économique Canada pour fonctionner avec les types d'antennes répertoriés dans la fiche technique SparkLAN WNFQ-268AXI(BT), avec le gain maximal autorisé indiqué. Les types d'antenne non inclus dans cette liste qui ont

un gain supérieur au gain maximum indiqué pour tout type répertorié sont strictement interdits pour une utilisation avec cet appareil.



**European Union (EU)
Radiation Warning
Statement and Con-
formance Notices**

Warning: This equipment complies with EU radiation exposure limits set forth for an uncontrolled environment. This equipment should be installed and operated with a minimum distance of 20 cm between the radiator and your body.

Selling Countries:



**Restrictions or
requirements
in the UK**

AT BE BG HR CY CZ DK

EE FI FR DE EL HU IE

IT LV LT LU MT NL PL

PT RO SK SI ES SE UK
(NI)

This device complies with the following EU

Directives: Directives 2014/53/EU, 2014/35/EU, and 2014/30/EU.

Accessory Information:

Adapter Model No.: FSP045-A1BR

Input: AC 100-240 V, 50/60 Hz 1.2 A

Output: DC 15 V, 3 A

Battery: 3250 mAh, 7.2 V 6.4 Ah

Japan Indoor Use Statement

For Japan, the EXG-300E is restricted for indoor use in the 5150-5530 MHz band only.

Taiwan Regulatory Statement

Article 12: For low-power RF motors that have passed the type certification, companies, firms or users are not allowed to change the frequency, increase the power, or change the features and functions of the original design without permission.

第十二條 經型式認證合格之低功率射頻電機，非經許可，公司、商號或使用者均不

得擅自變更頻率、加大功率或變更原設計之特性及功能。

Article 14: The use of low-power radio frequency motors shall not affect flight safety or interfere with legal communications; if any interference is found, it shall be stopped immediately, and it shall be continued to be used until there is no interference. The legal communication referred to in the preceding paragraph refers to the radio communication operated in accordance with the provisions of the Telecommunications Law. Low power radio frequency motors are subject to interference from legal communications or radio wave radiating electrical equipment for industrial, scientific and medical use.

第十四條低功率射頻電機之使用不得影響飛航安全及干擾合法通信；經發現有干擾現象時，應立即停用，並改善至無干擾時方得繼續使用。前項合法通信，指依電信法規定作業之無線電通信。低功率射頻電機須忍受合法通信或工業、科學及醫療用電波輻射性電機設備之干擾。

Wireless information transmission equipment operating in the 5.25-5.35 kHz frequency band is limited to indoor use.

在5.25-5.35 秭赫頻帶內操作之無線資訊傳輸設備，限於室內使用。



Complies with United Kingdom and European Economic Area radiation exposure limits

This equipment complies with the UK and EEA radiation exposure limits set forth for an uncontrolled environment. This equipment should be installed and operated with a minimum distance of 20 cm between the radiator and your body. The frequency and the maximum transmitted power in the UK and European Conformity are listed below:

2402-2480 MHz (LE) 9.63 dBm

2405-2480 MHz 9.81 dBm

2412-2472 MHz 19.96 dBm

5180-5240 MHz 22.95 dBm

5260-5320 MHz 22.98 dBm

5500-5700 MHz 22.98 dBm

5745-5825 MHz 22.98 dBm

5955-5825 MHz 22.98 dBm

5955-6415 MHz 22.97 dBm

6489-7987.2 MHz -41.58 dBm/RBW

The device is restricted to indoor use only when operating in the 5295 to 6425 MHz frequency range.

Hereby, NetAlly declares that the radio equipment EtherScope is in compliance with Radio Equipment Regulations 2017.

[Back to Title and Contents](#)

EtherScope nXG User Guide

Index

A

About screen 78

Access

- points 476

- points, details 589

- remote 137

Active

- discovery ports 501

- subnets 504

- survey 666

Adding

- AirMapper comments 669

- profile groups 200

- profiles 189

- test targets 336

Address

- Discovery 505

- extended range 502

Addresses

- Discovery 447

- subnet 502

Adjustments, signal 101

Advanced

- 802.11ax capabilities 599

- authentication 231, 276

- Wi-Fi connection 228

Air Quality profiles 376

- FAB 382-383

- results 378

AirMagnet 673

AirMapper

- active survey 659, 666

- app 647

- auto sampling survey 659

- change settings after start 657

- collecting data 659

- comments 669

- configuring 649
- connected survey 666
- deleting survey points 670
- export data 673
- hidden APs and SSIDs 658
- results, uploading 671
- settings 648
- settings, load and save 675
- survey 659
- Wi-Fi management port data 669

AllyCare

- activating 18
- code 786

Antenna

- directional 565
- dual-band flag 569
- external 562, 566
- internal 563

Apps 797

AirMapper 647

AutoTest 182

Cable Test 810

Capture 400, 824

configurations, saving 149

Discovery 414

Files 122

iPerf 746

LANBERT 763

Path Analysis 624

Performance 691

Ping/TCP 390

screen and store 46

settings, loading 142

settings, saving 146

Spectrum 676

testing 181

Wi-Fi 530

- APs 476
 - grouping rules 518
 - hidden 658
- ARP sweep rate 506
- Assigning device name 485
- Authentication 218
 - advanced 231, 276
- Authname file 494
- Authorization 485
 - batch 428
 - Wi-Fi 546
- Auto AP grouping rules 518
- Auto power off 53
- AutoTest
 - app 182
 - FTP test 366
 - HTTP test 354
 - importing/exporting profiles 203
 - main screen 204

- periodic 206
- ping test 342
- profiles 182
- profiles, Air Quality 376
- Profiles, Wi-Fi;profiles
 - Wi-Fi;Wi-Fi
 - profiles 211
- Profiles, Wi-Fi;Profiles
 - Wi-Fi;Wi-Fi
 - profiles 215
- profiles, Wi-Fi;profiles
 - Wi-Fi;Wi-Fi
 - profiles 237
- profiles, wired 262, 282
- results, Wi-Fi 237
- results, wired profile 282
- settings, transferring 154
- settings, Wi-Fi profile 215
- settings, wired profile 266

targets 335

TCP connect test 349

B

Batch authorization 428

Battery charging 29

Bluetooth 615

BSSIDs 593

 advanced 802.11 ax 599

 Interworking 600

Buttons 24

 FAB 116

C

Cable Test

 app 810

 open cable TDR test 814

 running 813

 settings 811

 terminated WireView test 817

- toning function 819-820
- Camera 120
- Captive portals 58
- Capture
 - running 408
 - settings 401
 - viewing 408
 - Wi-Fi filters 406
 - wired filters 405
- Certifications and compliance 839, 855
- Certificate 220
 - authority file 61
 - importing 222
- Changing
 - AirMapper settings 657
 - device language 73
- Channel utilization
 - Air Quality profile 382

Channels

- channel test settings 232

- details 581

- map, Wi-Fi 570

- overlap, Wi-Fi 573

- Wi-Fi 579

Charging and power 29

- charge via PoE setting 104

- PoE 29

Chromium browser 118

Claiming your test unit 782

Cleaning 33

Clear

- Wi-Fi problems 545

Clients 606

- certificates 65

- Wi-Fi 517

Colors, icons 204

Combine utilization 101

Comments, AirMapper 669

Common

 icons 115

 tools 118

Configuring

 AirMapper 649

 enterprise security 59

 iPerf 752

 LANBERT 764, 769

 Performance endpoints 718

 Performance source 701

 saving configuration 146, 149

 SNMP 507

Connecting

 devices, Discovery 459

 TCP Connect test 349

 Wi-Fi 55

 Wi-Fi advanced settings 228

 Wi-Fi profile 217

- Contact NetAlly 16
- Credentials, SNMP 502
- Custom Signal Adjustments 101
- Customer support 16

D

- Defaults, app settings 142
- Deleting survey points 670
- Details
 - APs 589
 - Bluetooth 618
 - BSSIDs 595
 - channels 581
 - client 608
 - Discovery
 - Discovery 436
 - interferers 622
 - Performance results 730
 - SSIDs 586

Wi-Fi 549

Device

discovery 514

endpoint 705

health 517

language 73

Layer 2 639

names 485

names, assigning 485

settings 50

types, Discovery 468

VoIP 516

Wi-Fi, locating 559

Device types

access points 476

hosts/clients 482

hypervisors 473

network servers 472

network tools 481

- printers 479
- routers 469
- SNMP agents 480
- switches 470-471
- virtual machines 474
- Wi-Fi clients 477
- Wi-Fi controllers 475, 478

DHCP

- settings 235
- test 309-310

Differences between models 23

Directional antenna 565

Discovery

- addresses 447
- app 414
- connected devices 459
- details screens 436
- device types 468
- FAB 463

- filtering list 423
- interfaces 452
- main list screen 418
- notifications 95
- ports 501
- problem settings 524
- problems 446
- refresh 433
- resources 460
- searching list 421
- security auditing 428
- settings 498
- SNMP 458
- sorting list 426
- SSIDs 461
- TCP port scan 449
- Test Accessory 749
- through other devices 514
- VLANs 451

Distance units 109

DNS

 settings 235

 test 324

 tests 309

Dual-band flag antenna 569

E

Ejecting storage media 129

Encryption 219

Endpoint

 configuring 718

 device 705

Enterprise security 59

Environmental specifications 838, 853

EtherScope

 additional resources 16

 feature access 165

 features 24

- models 23

- specifications 829, 844

EXG devices as Performance peer 742

Exporting

- AirMapper data 673

- AutoTest profiles 203

- logs 79

- settings 79, 150, 160

Extended ranges 502

External antenna 562, 566

F

FAB 116

- Air Quality profile 383

- BSSID 603

- clients 613

- Discovery 463

Factory defaults

- profiles 187

resetting 162

Files

app 122

authname 494

certificate authority 61

managing 122

moving and copying 125

sharing 68

text, sharing to Link-Live 801

Filters

Discovery list 423

Wi-Fi 406

Wi-Fi lists 538

wired 405

Flashlight 120

Floating action button (FAB) 116

FTP test, AutoTest 366

G

Gateway

- test 329
- test settings 235
- tests 309

General

- settings 97
- specifications 829-830, 844

Grading test results 326, 330, 345, 351, 358, 371

Graphs, trending 111

Grouping rules, AP 518

Groups, profile 187, 195

H

Hidden SSIDs and APs 658

Home screen 37

Hosts/clients, discovery 482

Hotspot 2.0 600

HTTP

- Proxy 235

- test 354

Hypervisors 473

I

Icons

- colors 204

- common 115

Importing

- AutoTest profiles 203

- certificate 222

- client certificate 65

- settings 150, 160

Interfaces, Discovery 452

Interferers 620

Internal antenna 563

Interval

- device health 517

- refresh 506

Interworking 600

iPerf

- app 746

- running 757

- settings 748

K

Kensington lock 27

L

LANBERT

- app 763

- generator settings 764

- loopback settings 769

- running 770

- settings 764

Language

- changing 73

- support 54

Layer 2 Devices 639

Layer 3 Hops 634

Legal notification 35

Link-Live

- app 780

- cloud service 780

- features 788

- getting started 782

- introduction 780

- job comment 794

- notifications 797

- private instance 787

- remote setting 108

- saving locally only 792

- software updates 796

- transferring settings 154

- uploading results 383, 434, 645, 671,
685, 738, 761, 777, 823

- uploading results, Wi-Fi 547

- wired testing with pairing 804

Link-Live Remote

- notifications 95

- using 139

LinkRunner AT (2000) 723

LinkRunner G2 721

LinkSprinter 804

List

- filtering, Discovery 423

- searching, Discovery 421

- sorting, Discovery 426

Loading

- AirMapper settings 675

- app settings 142

Local save 110

Locate

- Wi-Fi devices 559

Logs

- exporting 79

M

MAC, user-defined 102, 105

Machines, virtual 517

Maintenance and safety 32

Management

- files 122

- port notifications 93

- ports 81, 86

- settings 106

Map, channels 571

Micro SD card 26, 126

Models, differences between 23

N

Names, device 485

Navigation

- drawer 41, 76

- system 39

NetAlly

- contact 16
- support 16, 18

Network

- servers 472
- tools, discovery 481

Notifications

- discovery 95
- Link-Live 797
- Link-Live Remote 95
- management port 93
- panel 43
- system 43
- test and port status 90
- test port 91
- VNC 95

NPT reflector software 725

O

OneTouch 10G 719

OneTouch AT 10G 742

Overlap, Wi-Fi channels 573

Over-the-air updates 132

P

Passive

 survey 659

Passpoint 600

Password, VNC 108

Path Analysis

 app 624

 introduction 625

 Layer 2 devices 639

 Layer 3 hops 634

 manual configuration 626

 populating 626

 results 631

- running 629

- settings 626

Peer 718, 742

Performance

- app 691

- configuring source 701

- endpoint device 705

- endpoints 718

- introduction 693

- NPT reflector 725

- peer 718-719, 742

- reflector 718, 721, 723, 725

- results 728, 730

- running a test 727

- saving custom tests 696

- service 730

- settings 695

Periodic AutoTest 206, 208

Ping

- TCP app 390

- TCP app, running 396

- TCP settings 391

- test 342

PoE

- charge battery setting 104

- charging 29, 95

- test PoE before link 104

Portals, captive 58

Ports 24, 81

- Discovery 501

- management 86

- selecting 87

- TCP port scan 527

- test 82

Power

- auto power off 53

- powering on 31

- restart tester option 80
- Preferences 109
- Printers 479
- Private instance, Link-Live 787
- Problems
 - Discovery 446
 - settings 524
 - Wi-Fi 545, 552
- Product registration 16
- Profiles
 - adding 189
 - adding groups 200
 - Air Quality 376
 - exporting 203
 - groups 195
 - importing 203
 - managing 187
 - Wi-Fi 215
 - wired 262, 266, 282

Proxy, HTTP 235

R

Range, extended 502

Receive only setting 104

Reflector 718

Refresh

- Discovery 433

- Wi-Fi screens 545

Refresh interval 506

Register your product 16

Remote

- access 137

- Link-Live, using 139

- VNC 139

Remote Link-Live setting 108

Reset

- factory defaults 162

- trending graphs 113

- user name/authorization 494
- Resources, Discovery 460
- Restarting tester 80
- Restoring factory defaults 162
- Restricted subnets 504
- Results
 - Air Quality profile 378
 - AutoTest wired profile 282
 - AutoTest, Wi-Fi 237
 - Cable Test, uploading 383, 823
 - iPerf, uploading 761
 - LANBERT, uploading 777
 - Path Analysis 631, 645
 - Performance 728, 738
 - screen, test target 339
 - Spectrum 685
 - Wi-Fi, uploading 547
- Reverse grading 326, 330, 345, 351, 358, 371
- Routers 469, 515

Running

Capture 408

iPerf tests 757

LANBERT test 770

NetAlly devices as peers 742

Path Analysis 629

Performance test 727

Periodic AutoTest 208

Ping/TCP test 396

S

Safety and maintenance 32

Saving

AirMapper settings 675

app settings 146

configuration 149

iPerf settings 748

locally only 110, 792

Performance tests 696

Screen

- Discovery, main 418

- shot 71

SD card, micro 26

Searching, Discovery list 421

Security

- auditing, batch authorization 428

- auditing, Discovery 428

- enterprise 59

Selecting, ports 87

Server

- network, discovery 472

Settings

- AirMapper 648

- app defaults 142

- Cable Test 811

- Capture app 401

- channel test 232

- connection 217

- default 142
- device 50
- DHCP, DNS, and gateway 235
- Discovery 498
- Discovery, TCP port scan 527
- exporting 79, 150, 160
- general 97
- importing 150, 160
- iPerf 748
- LANBERT 764
- Link-Live remote 108
- management 106
- managing 142
- Path Analysis 626
- Performance 695
- periodic AutoTest 206
- Ping/TCP app 391
- preferences 109
- problems, discovery 524

- receive only 104
- Spectrum 677, 687
- TCP port scan 527
- test app 142
- transferring 154
- VNC 107
- Wi-Fi 98
- Wi-Fi connection 217
- Wi-Fi filters 406
- Wi-Fi profile 215
- Wi-Fi, advanced 228
- wired filters 405
- wired profile 266
- wired, general 103

Sharing

- files 68
- screen shot 71
- screens, Link-Live 798
- text files, Link-Live 801

Show internal storage 42, 495

Signal adjustments 101

SNMP

- agents 480

- configuration 507

- credential sets 502

- Discovery 458

- extended ranges 502

- query delay 513

Software

- manual updates 134

- updates 796

- updating 132, 135

Sorting

- Discovery list 426

- Wi-Fi lists 543

Specifications

- antenna 837

- device 829

environmental 838, 853

EXG-200 829

EXG-300 844

general 829, 844

wireless 830, 845

Spectrum

app 676

changing settings 688

frequency view 680

real time view 683

settings 677, 687

view, changing 687

waterfall view 682

SSH 118

SSIDs 584

Discovery 461

hidden 658

Static IP test 310

Statistics

- BSSID 601

- RF and traffic 554, 601, 610

Status

- bar 43

- notifications 90

Storage, media 129

Store 46

Subnet

- addresses 502

- mask 506

Subnets 515

- active v. restrictive 504

Support 16, 18

Survey PRO 673

Sweep rate, ARP 506

Switches 470-471, 516

System

- navigation 39

- notifications 43
- status bar 43

T

Targets

- addresses 338
- AutoTest 335
- test 235
- test results 339

TCP

- connect test 349
- port scan settings 527
- port scan, Discovery 449
- test app 390

Telnet/SSH 118

Test

- Accessory 746
- app defaults 142
- apps 181

- DHCP 310
- DNS 324
- FTP 366
- gateway 329
- HTTP 354
- notifications 91
- Ping/TCP 390
- port notifications 91
- ports 81-82
- static IP 310
- targets 235, 335
- targets, adding 336
- targets, managing 336
- targets, results 339
- TCP connect 349
- Test Accessory 749, 804
- Tips, user guide 19
- Tools, common 118
- Transfer, AutoTest settings 154

Trending graphs 111

 reset 113

U

Unclaiming unit 785

Unit

 claiming 782

 restarting 80

Units, distance 109

Unknown switches 471

Updating

 manual 134

 software 132, 796

Upload

 results to Link-Live 383, 434, 645, 671,
 685, 738, 761, 777, 823

 Wi-Fi results 547

USB

 drive 127

 Type-C to USB cable 129

User guide tips 19

User-Defined MAC 102, 105

V

Viewing, Capture 408

Virtual machines 474, 517

VLANs, Discovery 451

VNC

- notifications 95

- password 108

- remote 139

- settings 107

VoIP

- devices 516

- phones 478

W

Web browser 118

Wi-Fi

- app 530

- APs 589
- authorization 546
- Bluetooth 615
- BSSIDs 593
- channels 579
- channels map 570
- clients 606
- clients, discovery 477, 517
- connecting to 55
- connection, advanced 228
- controllers, discovery 475
- details screens 549
- filtering 538
- interferers 620
- list screens 534
- management port data, AirMapper 669
- problems, clearing 545
- problems, screen 552
- profiles 215

refreshing 545

RF and traffic statistics 554

screens 533

settings 98

sorting 543

SSIDs 584

Wired

profiles 262, 266, 282

testing with pairing 804

Wired, general settings 103

Wireless

specifications 829, 845