

# HPC40 Series Operation Manual

for the HPC40 Series Handheld Pressure Calibrator



# Contents

<b>Overview</b> .....	<b>1</b>	<b>Enclosure</b> .....	<b>21</b>
Introduction .....	1	<b>Specifications</b> .....	<b>22</b>
Quickstart .....	2	Ranges and Resolutions .....	27
<b>Functions</b> .....	<b>3</b>	Certifications .....	27
On/Off .....	3	<b>Support</b> .....	<b>28</b>
Navigation .....	3	Troubleshooting .....	28
Settings .....	5	Calibration .....	29
Display .....	8	Accessories and Replacement Parts .....	30
<b>Operation</b> .....	<b>9</b>	Contact Us .....	31
Pressure Sensors .....	9	Warranty .....	31
Measuring Current .....	13		
Sourcing Current .....	14		
Measuring Voltage .....	16		
Measuring Temperature (RTD) .....	17		
Performing a Switch Test .....	18		
Calibrating a Pressure Transmitter .....	19		

# Overview

## INTRODUCTION

Thank you for choosing the HPC40 Series handheld pressure calibrator from Crystal Engineering Corporation. HPC40 calibrators feature deadweight tester accuracy in a modern digital package with the safest fitting connection available. The new full color display also features a new easy to use interface similar to the one used in the JOFRA ASC-400 Series. The HPC40 is available as a stand-alone calibrator or in one of our complete pump systems, and may be used in a broad range of applications from simple tool type jobs to complex calibration jobs in custody transfer systems.

Accuracy is up to 0.035 percent of reading—so one HPC40 can typically replace several gauges or calibrators you may have been using. The HPC40 is fully temperature compensated—so there is no change in accuracy throughout the entire operating temperature range!

Single and dual pressure sensor models are available from vacuum up to 15 000 psi / 1000 bar. In addition, the HPC40 features the ability to add an external pressure port (APM) to provide up to 3 pressure ports. When included with a barometric reference (BARO option), all pressure readings can be displayed as gauge or absolute readings.

In addition to pressure measurement, the HPC40 also includes a full set of electrical connections. Inputs are included for mA, voltage, switch testing, and temperature measurement (RTD). An internal 24 VDC supply is also included to power mA transmitters.

### HPC40 Series Measurement Options

Measurement Type	Available Modes (as defined on display)
Pressure	P1, P2, APM, Diff. Pres, Dual Pres.
Temperature	RTD In
Barometric Pressure	BARO
Current	mA in, mA Out
Voltage	VDC In
Switch Test	Switch Test

Other features include:

- User configurable information display
- % error calculation
- Damping
- Leak Testing
- Min/Max hold
- Uses Crystal's new CPF fittings and hose system (leak-free and finger-tight to 10 000 psi (700 bar))

*We hope your HPC40 meets your expectations, and we're interested in any comments or suggestions you may have. You can send us a note at:*

*[crystal@ametek.com](mailto:crystal@ametek.com). Many features in this and our other products are a direct result of your comments!*

Crystal Engineering is the company that designs, manufactures, and services the nVision reference recorders, XP2i series pressure gauges, 30 series pressure calibrators, and a variety of industry specific pressure measuring equipment.

## QUICKSTART

### APM and Temperature Connection

Connect to an external APM module to expand the pressure options, plus a high accuracy RTD to read temperature.

### “Wireless” Keypad

All input and output connectors are placed away from the display and keypad to give maximum freedom to operate.

### Mini-USB Port

Customize the set-up through free CrystalControl software.

### Function Buttons

The function of each button is clearly explained on the bottom of the display.

### Color Display

The new large full-color display combined with the advanced simplicity of the new user interface, makes the HPC40 Series the easiest-to-use pressure calibrator available.

### Cursor Keys

Cursor keys help you to navigate through the display to perform set up functions and fine tune values.

### CPF Pressure Connections

Includes patented, leak-free, finger-tight CPF connection fittings.

### Unique “Non-Menu” User Interface

**Easy to use** single layer user interface. No deep menu structure! Operate and set up the HPC40 Series to perform your tasks quickly and intuitively.

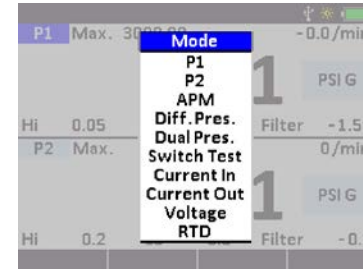

# Functions

## ON/OFF

### Power button



Press and hold the **(power)** button to turn the HPC40 Series on or off.

The HPC40 will automatically power down if not used for the time period defined in the unit settings or in CrystalControl.

### Automatic Shutoff - Low Power Mode



To optimize battery life, adjust your **Automatic Shutoff** time (shut off time in absence of key press) on the unit or through the free CrystalControl software. This feature is adjustable from 5 minutes to “always on.”

When powered by USB, the HPC40 does not employ any power management strategies. Therefore, it will not automatically shut off to the settings defined by CrystalControl.

## NAVIGATION

### Arrow Buttons



The **(arrow)** buttons serve different functions depending on the mode of operation. Press any of the four **(arrow)** buttons to enter “Navigation Mode”. In this mode, the user can scroll through editable fields directly onscreen. Any field that can be edited will be highlighted in **blue**.

**Navigation Mode:** Use the four **(arrow)** buttons to move the cursor in the desired direction.

**Edit Mode:** Use the Up and Down **(arrow)** buttons to scroll through lists of options. Or, if entering a number, use the left and right **(arrow)** buttons to move the cursor one character in the desired direction.

### Back Button



Press the **(back)** button to cancel a selection or to return to a previous menu.

### Enter Button



Press the **(enter)** button to view/accept selected options or entered values. When a value is entered with the **(enter)** button, the cursor selects the next value field in the list.

## Zero Button



Press the **(zero)** button to activate the function key options. The HPC40 will display the parameters that are currently shown on the upper and lower displays. Press the **(function)** button for the parameter that you would like to zero. The display will then briefly flash all dashed lines (----), indicating that it has been zeroed.

**Note:** If you attempt to zero the gauge with more pressure applied than the Zero Limit set on the HPC40 (or with CrystalControl) the command will be ignored, and **Over Zero Limit** will display.

**Note:** The BARO sensor cannot be zeroed.

**! WARNING:** This calibrator can display zero pressure when connected to a source of pressure! Do not rely on the display indication before disconnecting—it may not be indicating true pressure. Never disconnect pressure instrumentation without first relieving system pressure!

### ► To Clear the Zero Value

- 1 Press the **(zero)** button to activate the **(function)** buttons for the available pressure sensors.
- 2 Press and hold the **(function)** button for the sensor that you would like to unzero until the display changes from (----) to (- - -).

### ► To Clear the Peaks

- 1 Press the **(zero)** button to activate the **(function)** buttons for the available pressure sensors.
- 2 Press the **(function)** button for **Peaks** to reset the P1, P2, and APM peaks.

## Navigating Through a Typical Setup

- 1 Press any of the **(arrow)** buttons to enter Navigation Mode. Editable fields will be highlighted in **blue**.
- 2 Use the **(arrow)** buttons to move between the configurable fields within the upper and lower displays. Selected fields will be highlighted in **dark blue**.

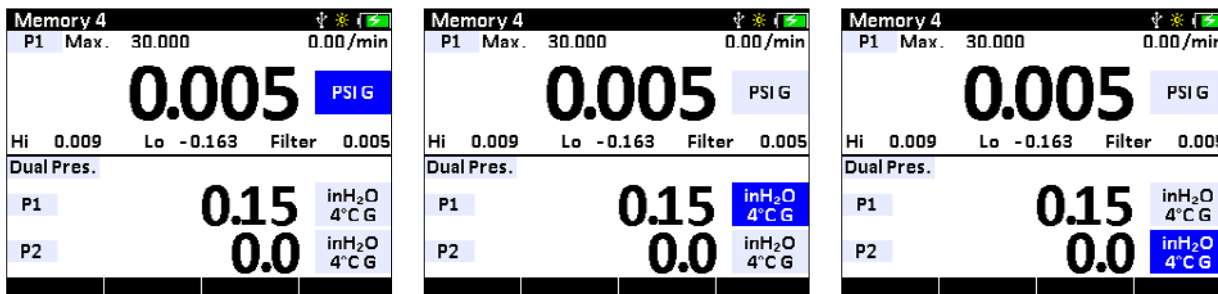

- 3 Use the **(enter)** button to select a field for editing.

4 Use the up and down (arrow) buttons to select a new value, then press the (enter) button to choose the new value.

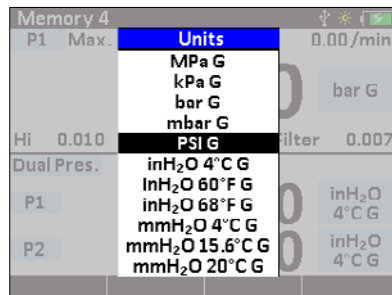

Select a Value...

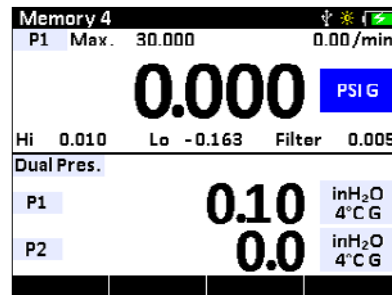

then press enter.

**Note:** To exit Navigation mode without making a selection, press the (back) button.

## SETTINGS

### Settings Button



Press the (settings) button to enter the system settings menu.

#### ► Recall

Used to recall a saved setup.

#### ► Save

Used to store the current display setup. Saving a setup allows for quick loading of the same configurations for later use. This makes it easy to switch between different applications or tasks. Up to 5 setups can be stored.

#### ► General

Used to view or edit the following system settings:

- Auto Off Time
- HART resistor On/Off
- Battery Chemistry
- Serial Number
- Firmware Version
- Part Number

**► P1, P2, and APM**

- Mode: Switch between absolute and gauge pressure.
- Filter Time
- Zero Limit
- Custom Engineering Unit
- Serial Number
- Range
- Maximum Resolution: When a resolution less than standard is selected, the displayed number will include an asterisk (\*).
- View Calibration Details

**► RTD In**

- Define Custom RTD
- Serial Number
- Maximum Resolution: When a resolution less than standard is selected, the displayed number will include an asterisk (\*).
- View Calibration Details

**► mA In, mA Out, VDC In**

- Serial Number
- Maximum Resolution: When a resolution less than standard is selected, the displayed number will include an asterisk (\*).
- View Calibration Details



► **To Save a Setup**

After you have configured the unit, you can save the setup for future use.

- 1 Press the (settings) button to enter the settings section.
- 2 Press the (arrow) buttons to highlight the Save Setting, and the press the (enter) button.
- 3 Press the (arrow) buttons to highlight the setup you want to modify, and then press the (enter) button.
- 4 Use the (arrow) buttons to change the name of the saved setup. When finished press the (enter) button.

The name is limited to eight characters.

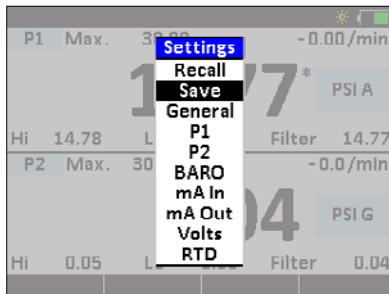

Highlight the settings to modify...

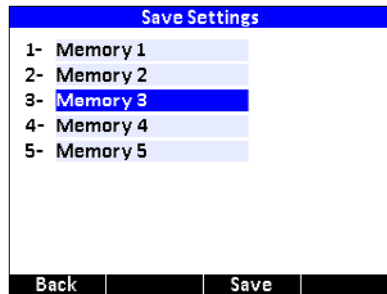

then change the name of the saved setup.

- 5 Press the (F3) function button for Save.

► **To Recall a Setup**

- 1 Press the (settings) button to enter the settings section.
- 2 Press the (arrow) buttons to highlight the Recall Setting, and then press the (enter) button.
- 3 Press the (arrow) buttons to highlight the setup you want to use, and then press the (enter) button.

The name of the setup will appear in the upper-left corner

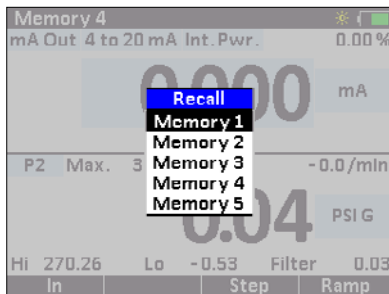

Highlight the setup...

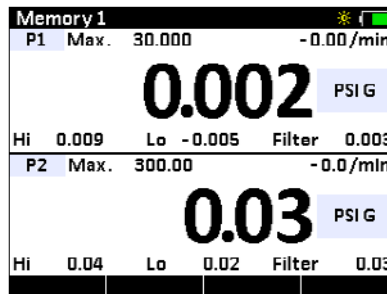

then press enter.

## DISPLAY

The display is divided into two sections: the upper and lower displays. The upper display can be configured to show values for Current, Voltage, RTD, Pressure, BARO, or Switch Test. The lower display can be configured to show values for only RTD, Pressure, and BARO.

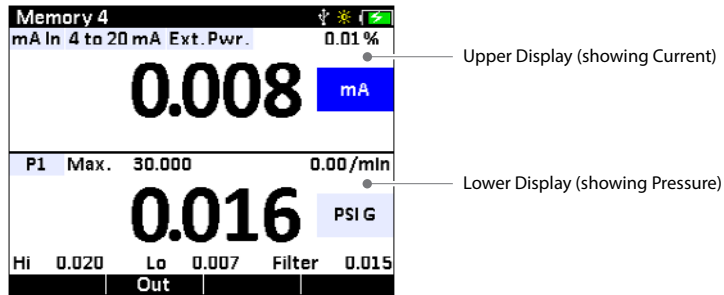

# Operation

## PRESSURE SENSORS

The HPC40 Series is equipped with one or two pressure sensors. In addition, a Crystal APM (Advanced Pressure Module) may also be used. For information on the Crystal APM, please refer to the [APM CPF Series Operation Manual](#). Be sure to choose the proper sensor based on working pressures and accuracy.

**! WARNINGS:** The following warnings apply to any sensor used with the HPC40 — whether internal or external:

- Pressure sensors may be damaged and/or personal injury may occur due to improper application of pressure. Please refer to the [Ranges and Resolutions table](#) for information on overpressure ratings.
- The calibrator will display **+OL** when an inappropriate pressure is applied. If **+OL** is displayed, the pressure should be reduced or vented immediately to prevent damage or possible personal injury.

**Note:** **+OL** is displayed when the pressure exceeds 110% of the nominal range of the sensor.

### Pressure Connection

Crystal CPF System: Medium Pressure Female (MPF) (1/4" medium pressure tube system with 7/16-20 threads). See our [CPF brochure](#) for further information.

CPF o-ring size and material: AS568A-012, Viton 80 or 90 durometer (P/N 3981).

For most applications CPF Fittings can be hand tightened (no tools required). Wrench tightening is recommended (to achieve a metal to metal cone seal) for applications where chemical compatibility of the process fluid and the o-ring are a concern. Cone seals require only moderate assembly torque to seal up to 10 000 PSI (700 bar). We recommend a tightening torque of 120 in-lbs  $\pm$ 20 in-lbs for our CPF fittings. Please note this is only a fraction of the typical torque required to seal a 1/4" NPT fitting. If a torque wrench isn't practical to use, the fittings can be assembled as follows: Hand tighten fitting fully until the cone has bottomed out, then tighten an additional 20° using a hex wrench. Apply a small amount of media-compatible lubricant to the gland threads and male cone to increase fitting life, reduce the likelihood of galling, and promote sealing.

**! CAUTION:** To achieve CPF maximum allowable working pressures no o-ring substitutions are allowed. See our CPF brochure and CES-003 CPF Safety Guide available from the website at [ametech.com](http://ametech.com) for further detail.

### Measuring Vacuum

All versions of the HPC40 can be used to measure moderate vacuum.

When measuring pressure less than ambient barometric conditions, a minus (-) sign will appear.

**! CAUTION:** The HPC40 is not recommended for continuous use at high vacuum.

## Overpressure Conditions

The HPC40 Series will read pressure up to approximately 110% of the rated pressure range. Above 110%, the display will indicate **+OL**, and readings will stop updating. The zero function does not affect when the display will indicate **+OL**, so depending on the zero value it is possible that the display will indicate **+OL** without the maximum pressure being displayed.

For instance, if a 100 psi range is zeroed when 30 psi is being applied, it will indicate that the overpressure condition has been reached at 80 psi (i.e., 110% x 100 psi – 30 psi = 80 psi).

Overpressure can affect accuracy, but the effect is only temporary unless the sensor has been destroyed. See the [Ranges and Resolutions table](#) for maximum allowable overpressure ratings.

## Measuring Pressure

### ► To Measure Pressure

- 1 Connect the HPC40 using an appropriate fitting.
- 2 Select one of the pressure modes: **P1**, **P2**, **APM**, **BARO**, or **Dual Pres.**

For more information on working in the HPC40 display, see [Navigating Through a Typical Setup](#).

- 3 From the HPC40 display, select the desired pressure units.

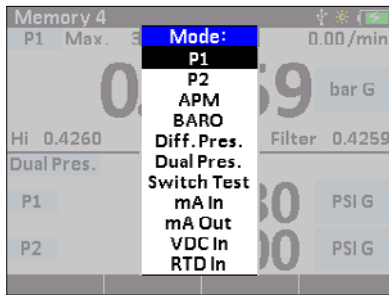

Select a pressure mode...

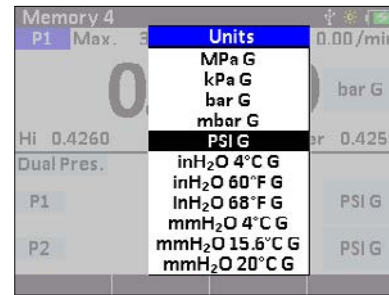
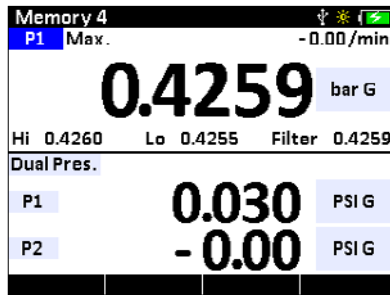

then select a pressure unit.

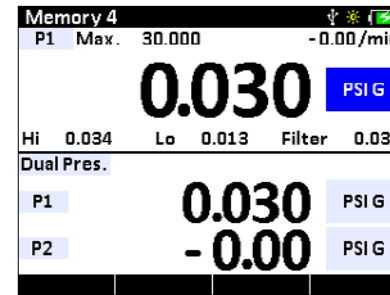

- 4 Apply pressure to the device under test.

### ► Absolute Pressure (BARO Option)

See [P1, P2, or APM](#) settings to toggle between absolute and gauge pressure.

### ► To Zero the Calibrator

- 1 Press the **(zero)** button to activate the **(function)** buttons for the available pressure sensors.
- 2 Press the **(function)** button for the sensor that you would like to zero.

The display will change to dashed lines ( - - - - ) and the reading will be zeroed.

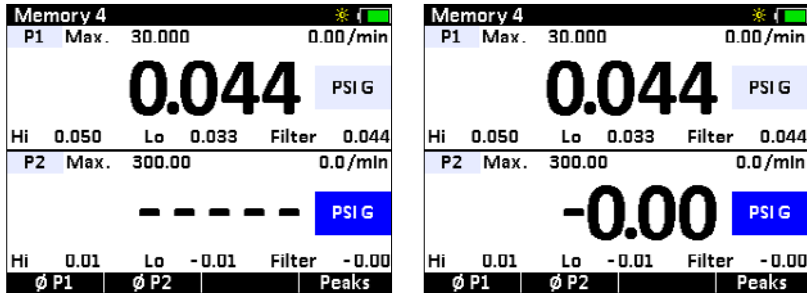

Zeroing the P2 sensor.

### ► To Clear the Zero Value

- 1 Press the **(zero)** button to activate the **(function)** buttons for the available pressure sensors.
- 2 Press and hold the **(function)** button for the sensor that you would like to unzero until the display changes from ( - - - - ) to ( - - - - ).

### ► To Clear the Peaks

- 1 Press the **(zero)** button to activate the **(function)** buttons for the available pressure sensors.
- 2 Press the **(function)** button for **Peaks** to reset the P1, P2, and APM peaks.
- 3 Press the **(function)** button for the peaks you would like to clear. The **Hi**, **Lo**, and **Filter** will all display ( - - - - ).

**Note:** If you attempt to zero the gauge with more pressure applied than the Zero Limit set on the HPC40 (or with CrystalControl) the command will be ignored, and **Over Zero Limit** will display.

**Note:** The BARO sensor cannot be zeroed.

**! WARNING:** This calibrator can display zero pressure when connected to a source of pressure! Do not rely on the display indication before disconnecting—it may not be indicating true pressure. Never disconnect pressure instrumentation without first relieving system pressure!

## Differential Pressure

The HPC 40 Series can display differential pressure when 2 or more sensors are installed (including external APM). The modules do not have to be the same full scale pressure range.

### ► To Display Differential Pressure

- 1 Select *Diff. Pres.* from the Mode section.
- 2 Choose the two sensors that you want to use for differential pressure.
- 3 Choose the unit for the differential reading.

For more information on working in the HPC40 display, see [Navigating Through a Typical Setup](#).

- 4 Apply pressure to one or both sensors to read the differential.

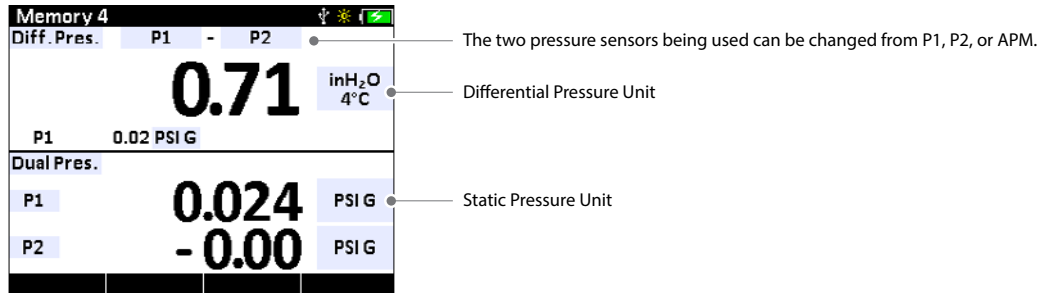

**Note:** The static pressure is also displayed on the bottom of the window. The unit for the static pressure does not have to be the same as the differential unit.

## Tare

Using the Tare function improves your differential measurement uncertainty significantly if used properly. The Tare function equalizes (normalizes) the HPC40's two modules at a non-ambient datum.

If you apply the same static line pressure to both sensors simultaneously, you should have a differential reading of zero. Due to the allowable error tolerance for each module, the reading may not be zero. The Tare function allows you to normalize both readings so that the differential reading is zero. This gives you a more accurate differential reading than if this process were not completed.

**Note:** Tare should be reestablished every time your measurement conditions change, including vent condition. For instance if your  $\Delta P$  reading has 8 inH<sub>2</sub>O of Tare at 1500 psi static, when you return to vent condition this 8 inH<sub>2</sub>O of Tare will remain in place on your  $\Delta P$  reading until cleared with the Tare button.

To Tare:

- 1 Use the (arrow) buttons to navigate to the Differential Mode view.
- 2 Press the (zero) button to activate the function button options.
- 3 Press the (function) button for the (  $\emptyset$  Diff  $\uparrow$  ) icon.

**Note:** You will notice that the word *Tare* is now included on the top right of the display to indicate that the sensors have been tared.

- 4 To clear the Tare value in the Differential Mode, hold the (function) button for the (  $\emptyset$  Diff  $\uparrow$  ) icon for four seconds until the differential display readings change from (----) to (--). The tare indication will now be removed from the display.

## MEASURING CURRENT

The HPC40 is capable of measuring current in four different modes:

- **mA** Measured current is displayed (mA). The module is capable of measuring inputs up to 55 mA.
- **0-20 mA** Current is displayed as a percentage of the 0-20 mA current range of the module. Where: 0 mA = 0%, and 20 mA = 100%
- **4-20 mA** Current is displayed as a percentage of the 4-20 mA current range of the module. Where: 4 mA = 0%, and 20 mA = 100%
- **10-50 mA** Current is displayed as a percentage of the 10-50 mA current range of the module. Where: 10 mA = 0%, and 50 mA = 100%

### ► To Measure Current

- 1 Select **mA In**.

For more information on working in the HPC40 display, see [Navigating Through a Typical Setup](#).

- 2 In current mode, the numerical value displayed represents the current measured at the test lead inputs. In the top right corner is a percentage value based on whether **0 to 20 mA**, **4 to 20 mA**, or **10 to 50 mA** is selected.

For example, if the measured current is 16 mA and the selected scale is 4 to 20 mA, the percent will display as 75%.

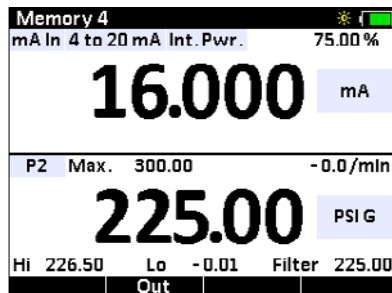

Measuring Current.

- 3 Select **Ext. Pwr.** from the power source list if the mA loop is already powered, or **Int. Pwr.** to have the HPC40 supply the power.

**Int. Pwr.** is not available in the 10-50 mA range.

- 4 Connect the HPC40 using the appropriate test leads.

- 5 The HPC40 will display the measured current.

**Note:** The display will indicate **+OL** if the measured current exceeds the nominal range of current measurement (55 mA).

**Note:** For details on % error and scaling features [see page 20](#).

## SOURCING CURRENT

The HPC40 is capable of sourcing up to 25 mA.

### ► To Source mA (Internal Loop Power Supply)

- 1 Select *mA Out*.
- 2 Select the appropriate range (0-20 or 4-20) if you will be sourcing based on the % of the scale.
- 3 Choose *Int. Pwr.* from the power source list.
- 4 Choose either *mA* (to output a specific mA signal), or *%* (to output based on the % of the mA range).

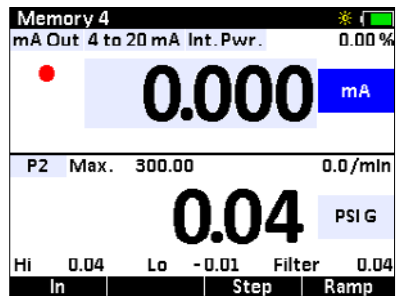

- 5 Connect the HPC40 using the appropriate test lead connections.
- 6 Enter the desired current in mA or % to source.

### ► mA Sink (External Loop Power Supply)

- 1 Select *mA Out*.
- 2 Select the appropriate range (0-20 or 4-20) if you will be sourcing based on the % of the scale.
- 3 Choose *Ext. Pwr.* from the power source list.
- 4 Choose either *mA* (to output a specific mA signal), or *%* (to output based on the % of the mA range).
- 5 Connect the HPC40 using the appropriate test lead connections.
- 6 Enter the desired current in mA or % to sink.



### ► mA Step

The HPC40 has the ability to automatically or manually step through the mA range at predefined intervals.

- 1 Select *mA Out*.
- 2 Select the appropriate mA range (0-20, 4-20).
- 3 Select *Ext. Pwr.* from the power source list if the mA loop is already powered, or *Int. Pwr.* to have the HPC40 supply the power.
- 4 Press the (function) button for *Step*.
- 5 Enter the 0 and 100% mA points. For example, if you're sourcing to a 4-20 mA loop, enter 4 for the 0% point and 20 for the 100% point.
- 6 Choose the step size from 10%, 20%, or 25%. This is the percent of the mA range that will be increased with each step.
- 7 Enter the time between each step you would like to use.

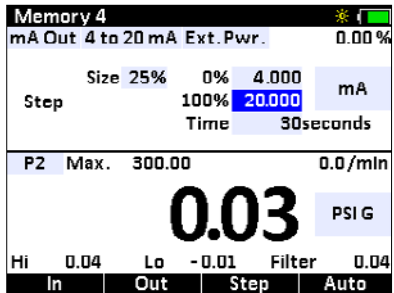

- 8 Press the (function) button for *Auto*, and the HPC40 will automatically start the step process.
- 9 Press the (function) button for *back* when finished. Or, if you would like to pause the step function and increase manually, press *Stop*. If you press *Stop*, new function keys *-Step* (decreasing a single step) and *+Step* (increasing a single step) are now available.

### ► mA Ramp

The HPC40 has the ability to provide a consistent ramp throughout the full mA range.

- 1 Select *mA Out*.
- 2 Select the appropriate mA range (0-20, 4-20).
- 3 Select *Ext. Pwr.* from the power source list if the mA loop is already powered, or *Int. Pwr.* to have the HPC40 supply the power.
- 4 Press the (function) button for *Ramp*.
- 5 Enter the 0 and 100% mA points.

- 6 Enter the total time to get from 0 to 100% of the scale.

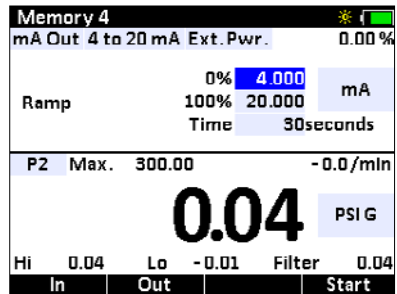

- 7 Press the (function) button for **Start** and the HPC40 will begin the ramp process.
- 8 Press the (function) button for **Stop** to pause the ramp, or **Back** to go back to the ramp setup screen.

## MEASURING VOLTAGE

The HPC40 may be used to measure voltages up to 30VDC. Voltage measurements are limited to the upper display.

### ► To Measure Voltage

- 1 Select **VDC In**.

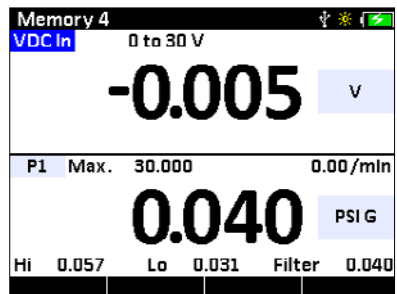

For more information on working in the HPC40 display, see [Navigating Through a Typical Setup](#).

- 2 Connect the HPC40 using the appropriate test leads.
- 3 The HPC40 will indicate the measured voltage.
- Note:** The display will indicate **+OL** if the measured voltage exceeds the nominal range of voltage measurement (30 VDC).

## MEASURING TEMPERATURE (RTD)

Your HPC40 has the ability to measure temperature very accurately using “true ohm” technology. True ohm resistance measurement eliminates temperature reading errors by compensating for thermoelectric effects associated with the wires and connections between the RTD and the HPC40. The HPC40 will also indicate electrical resistance ( $\Omega$ ) to help in troubleshooting your resistance based sensing element.

RTDs are characterized by their 0° C resistance, R0. The HPC40 accepts -2, -3, and -4 wire inputs, with 4 wire input being the most accurate.

The HPC40 is compatible with a large number of platinum RTD probe types. Ametek offers a platinum 100 probe that is ready to connect directly to the HPC40’s RTD port. See [Accessories and Replacement Parts](#) for details.

### ► To Measure Temperature

- 1 Select **RTD In**.

For more information on working in the HPC40 display, see [Navigating Through a Typical Setup](#).

- 2 In RTD mode select an RTD type from the RTD Type list.

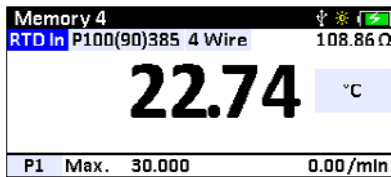

Select RTD...

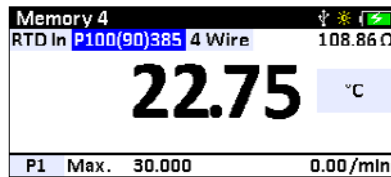

then select an RTD type.

- 3 Select a wire connection from the Num Wires list: **2-wire**, **3-wire**, or **4-wire**.

4-wire allows for the most accurate measurement

- 4 Select the appropriate unit from the list.

- 5 Connect your RTD probe to the HPC40.

If you have our probe (PN 127387), plug it in to the HPC40’s RTD port and select probe type P100(90)385, 4-wire. If you wish to connect your own RTD probe, you may do so by connecting your probe wires per the HPC40 RTD port diagrams below, and using a mating connector from Lemo’s 1S.304 series.

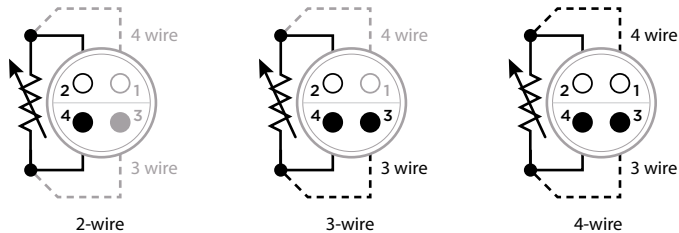

- 6 The HPC40 will display the measured temperature.

**Note:** **+OL** will be displayed if the probe resistance is greater than 400 Ohms and/or the calculated temperature is outside the range defined for the probe. Temperature range depends on the probe type.

## PERFORMING A SWITCH TEST

Performing a switch test will require the use of both screens. The HPC40 records switch state, and pressure or temperature measurement at the time of switch change. After the test, the result is displayed in a convenient and easy-to-use format.

### ► To Perform a Switch Test

- 1 Select **Switch Test** in the upper display.
- 2 **FOR A PRESSURE SWITCH**, select *P1*, *P2*, *Diff. Press.*, or *APM* in the lower display.  
**FOR A TEMPERATURE SWITCH**, select *RTD In* in the lower display.  
 For more information on working in the HPC40 display, see [Navigating Through a Typical Setup](#).
- 3 Connect the HPC40 to the switch using the terminals on the top of the HPC40. (The polarity of the terminals does not matter.)
- 4 **FOR A PRESSURE SWITCH**, connect a pump to the HPC40 and then to the switch.  
**FOR A TEMPERATURE SWITCH**, connect an RTD to the HPC40 connection and place the RTD and temperature sensor in a temperature calibrator.
- 5 Check that the vent on the pump is open, and zero the calibrator if necessary. Then close the pump vent.

The upper display will show no read outs for the *Closed*, *Opened*, and *Dead band* values.

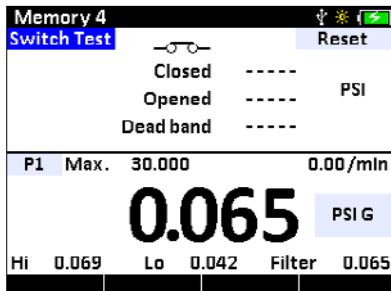

- 6 Slowly apply pressure or temperature until the switch opens.  
 Once the switch is open, the switch icon will change to , and the display will indicate pressure at which the switch opened.

**Note:** In the switch test mode, the display update rate is increased to ten readings per second to help capture the changing switch state. Even with this enhanced sample rate, pressurizing the device under test should be done slowly to ensure accurate readings.

7 Decrease pressure or temperature until the switch closes.

Once the switch closes, the icon will change to (—○—) and the **Closed** value and **Dead band** value will be indicated.

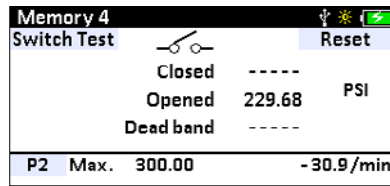

Switch Open

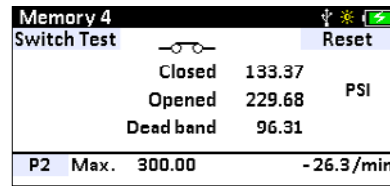

Switch Closed

8 To perform a new test, highlight the reset option and press the (enter) button.

The **Closed**, **Opened**, and **Dead band** value will all be blank again.

**Note:** The procedure is the same whether the default mode for the switch is opened or closed. So for example, applying pressure or temperature to an open switch will cause the switch to close, and the icon will change to (—○—) as in step 7 above.

## CALIBRATING A PRESSURE TRANSMITTER

When calibrating a transmitter, both the upper and lower displays are used. Pressure and Temperature Transmitters with ranges of 0 to 20 mA, 4 to 20 mA, and 10 to 50 mA can be calibrated by an HPC40. The example below will use a 4 to 20 mA pressure transmitter.

### ► To Calibrate a Pressure Transmitter

1 Select **mA In** in the upper display and **P1** in the lower display.

2 Select **4 to 20mA** from the Range list.

3 Select **Ext. Pwr.** from the power source list if the mA loop is already powered, or **Int. Pwr.** to have the HPC40 supply the power.

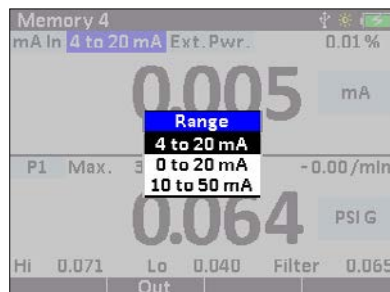

Select 4 to 20mA...

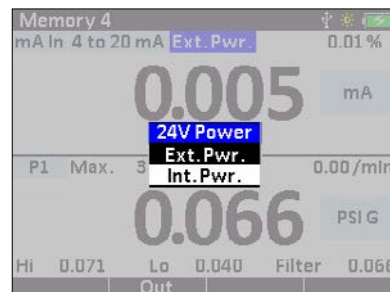

then select Int. Pwr. or Ext. Pwr.

4 Connect the HPC40 to the transmitter.

### ► HART Resistor

The HPC40 has an internal 250 Ohm HART resistor that can be selected if desired. With the (settings) button, choose **General** to select HART resistor On or Off.

### ► Percent Error Function

The HPC40 can be programmed to calculate a deviation or % error from 4-20 mA output. This eliminates the need for manual calculations and can also be helpful if it becomes difficult to set an exact pressure with an external pump. The HPC40 simultaneously displays pressure, mA, and percent error.

- 1 Select **% Error** from the mA units selection in the upper window.
- 2 Use the (arrow) buttons to set the 0 and 100% points for both the mA and pressure ranges of the transmitter.

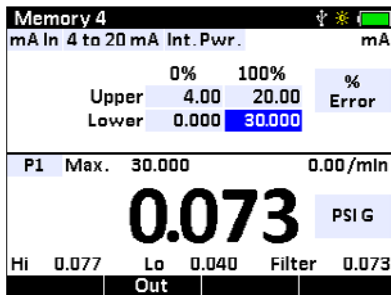

- 3 Increase pressure to the desired point and the HPC40 upper display will indicate the % error as well as the actual mA value. The lower display will show the measured pressure.

### ► Scaling Function

The HPC40 has the ability to read current or voltage in the upper display that is scaled to and displayed in the same units as the lower display. This makes it much easier to compare a mA reading to a known accurate pressure reading.

- 1 Select **Scaling** from the mA units selection in the upper window.
- 2 Use the (arrow) buttons to set the 0 and 100% points for both the mA (or VDC) and pressure ranges of the transmitter.
- 3 Increase pressure to the desired point and the HPC40 upper display will indicate the equivalent pressure based on the mA reading, as well as the actual mA value. The lower display will show the measured pressure.

# Enclosure

## INFORMATION

- Weight ..... 689 g (24.3 oz) (includes batteries).
- Housing ..... Machined aluminum; hard anodized.
- Rating ..... IP65.
- Keypad and Labels ..... UV Resistant Silicone.

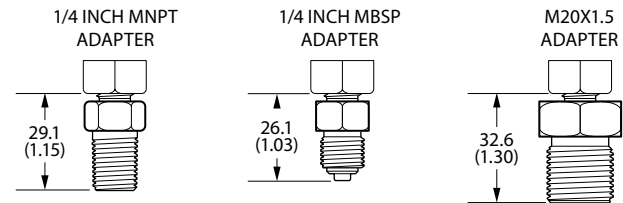
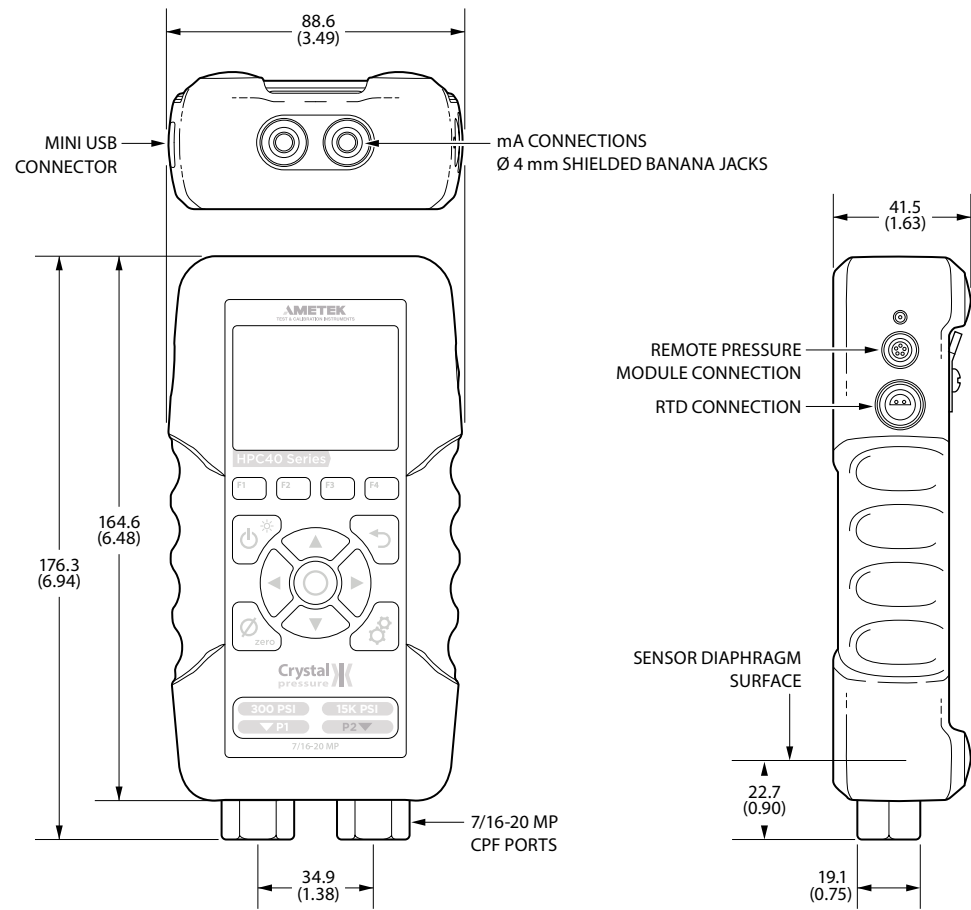

ADDITIONAL SENSOR LENGTH WITH OPTIONAL FITTING ADAPTERS

# Specifications

## Gauge Pressure Accuracy

Includes all effects of linearity, hysteresis, repeatability, temperature, and stability with the operating temperature range for one year.

**Note:** Exposure to environmental extremes of temperature, shock, or vibration may warrant a more frequent calibration period.

The HPC40 Series must be exercised and re-zeroed whenever exposed to significant changes in environmental conditions to achieve these specifications. To exercise a gauge, cycle the gauge between zero (ambient barometric pressure) and the pressure of interest. A properly exercised gauge will return to a zero reading (or return to the same ambient barometric reading).

### ► Gauge Pressure (psi)

#### • 18 to 28° C

0 to 30% of Range . . . . .  $\pm(0.01\%$  of Full Scale)  
 30 to 110% of Range . . . . .  $\pm(0.035\%$  of Reading)  
 Vacuum\* . . . . .  $\pm(0.05\%$  of Full Scale\*\*)

#### • -20 to 50° C

0 to 30% of Range . . . . .  $\pm(0.015\%$  of Full Scale)  
 30 to 110% of Range . . . . .  $\pm(0.050\%$  of Reading)  
 Vacuum\* . . . . .  $\pm(0.05\%$  of Full Scale\*\*)

\*Applies to 300 psi and lower ranges only.

\*\*Full Scale is the numerical value of the positive pressure range.

**! CAUTION:** Not recommended for continuous use below -14.5 psig. Refer to the [XP2i-DP](#) data sheet for gauges that are intended for continuous high vacuum use.

### ► Absolute Pressure with BARO Option (psiA)

All absolute accuracies are equivalent to the gauge pressure accuracies, except as noted below.

30 psi Range . . . . . Gauge Accuracy +0.005 psiA  
 100 psi Range . . . . . Gauge Accuracy +0.002 psiA



► **Differential Pressure**

The Tare function can improve differential pressure measurement uncertainties. Requires the use of an equalizing valve. Use the higher range sensor specification when two different ranges are selected.

Full Scale Range of Both Sensors	The Greater of (+/-)				or	% of DP Reading
	psi	mbar	inH <sub>2</sub> O	mmH <sub>2</sub> O		
30	0.0005	0.04	0.014	0.4	0.035%	
100	0.0015	0.10	0.04	1.0		
300	0.005	0.4	0.14	4.0		
1000	0.02	1.0	0.4	10.0		
3000	0.05	4.0	1.4	n/a		
10000	0.2	10.0	4.0	n/a		
15000	0.3	15.0	6.0	n/a		

 Unit is enabled in CrystalControl

• **Without tare function:**

±(0.05% of static line pressure reading)

**Barometric Reference**

Accuracy ..... ± 0.00725 psi, ± 0.5 mbar

Accuracy specifications include all effects of linearity, hysteresis, repeatability, temperature, and stability within the specified operating temperature range for one year.

**Note:** Exposure to environmental extremes of temperature, shock, and/or vibration may warrant a more frequent recertification period.

**Pressure Sensor (P1 and P2)**

Wetted Materials. .... (WRENCH TIGHT) 316 stainless steel

(FINGER TIGHT) 316 stainless steel and Viton® (internal o-ring)

Diaphragm Seal Fluid: ..... Silicone Oil

Connection: ..... Crystal CPF Female

---

## Pressure Conversions

1 PSI = 27.6806 inches of water column (water at 4°C [39.2°F])  
 703.087 millimeters of water column (water at 4°C [39.2°F])  
 70.3087 centimeters of water column (water at 4°C [39.2°F])  
 2.03602 inches of mercury (mercury at 0°C [32°F])  
 51.7149 millimeters of mercury (mercury at 0°C [32°F])  
 6.8948 kilopascals  
 0.070307 kilograms per square centimeter  
 0.068948 bar  
 68.948 millibar  
 0.0068948 megapascals

**Note:** Other conversions may have been specified at time of order. Refer to your certificate of calibration for details.

---

## Temperature

Accuracy ..... ±(0.015% of rdg) + 0.02 Ohm  
 Range ..... 0 – 400 Ohms  
 Resolution ..... 0.01 on all scales  
 Units ..... °C, K, °F, R, Ω  
 Types ..... 13 standard and 1 custom  
 Wiring ..... 2-, 3-, and 4-wire support  
 Connection ..... Lemo Plug, 15 Series, 304 insert configuration

## Electrical

All accuracy specifications include all effects of linearity, hysteresis, repeatability, temperature, and stability within the specified operating temperature range for one year.

**Note:** Exposure to environmental extremes of temperature, shock, and/or vibration may warrant a more frequent recertification period.

Connection ..... 4 mm jacks  
Maximum Voltage ..... 45 VDC

### ► Current (mA) Input

Accuracy .....  $\pm(0.015\% \text{ of rdg} + 0.002 \text{ mA})$   
mA Range ..... 0 to 55 mA  
Percent Range ..... 0-20, 4-20, 10-50  
Max Allowable Current ..... 60 mA  
Resolution ..... 0.001 mA or 0.01%  
Units ..... mA and %  
Input Resistance .....  $< 17.2 \Omega$   
Voltage Burden @ 20mA .....  $< 0.35 \text{ V}$   
Voltage Burden @ 50mA .....  $< 0.86 \text{ V}$   
HART Resistor ..... 250  $\Omega$

### ► Current (mA) Output

Accuracy .....  $\pm (0.015 \text{ of rdg} + 0.002 \text{ mA})$   
Range ..... 0 to 25 mA  
Step Time ..... 1 to 999 seconds  
Ramp Time ..... 5 to 999 seconds

### Voltage (VDC) Input

Accuracy .....  $\pm(0.015 \% \text{ of rdg} + 2 \text{ mV})$   
Range ..... 0 to 30 VDC  
Resolution ..... 0.001 VDC  
Input Impedance .....  $> 1 \text{ MOhm}$

### ► Loop Power

Fixed Output ..... 24 VDC  
Voltage Output Accuracy .....  $\pm 10\%$   
Maximum Output Current ..... 25 mA

### ► Switch Test

Switch Type ..... Dry Contact  
Closed State Resistance .....  $< 1 \text{ K} \Omega$   
Open State Resistance .....  $> 100 \text{ K} \Omega$   
Sample Rate: ..... 10 Hz

## Display

Screen ..... 320 x 240 pixel graphical display  
Display Rate ..... 3 readings/second (standard)  
10 readings/second (switch test and peak hi/lo modes)

## Operating and Storage Temperature

Operating Temperature Range ... -20 to 50° C (-4 to 122° F)  
Storage Temperature Range ..... -40 to 75° C (-40 to 167° F)

## Power

The HPC40 can be powered by batteries or USB. The USB port can also be used to recharge appropriate batteries.

### ► Power Icon States

The HPC40 battery icon indicates how much battery life is remaining.

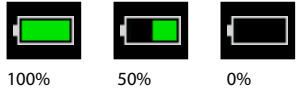

### ► Battery Power

The HPC40 uses four(4) size AA (LR6) batteries. It can be used with rechargeable or non-rechargeable batteries.

**Note:** If the batteries discharge too deeply, the calibrator will automatically shut down to avoid battery leakage and false measurements.

### ► Acceptable Batteries

Type	Cell Voltage
Alkaline	1.5 V
NiMH	1.2 V
Lithium	1.5 V

### ► Battery Life

Settings such as Auto Shutoff and Backlight level greatly vary battery life.

Battery Life ..... >12 hours non-sourcing  
>8 hours when sourcing 12 mA

Recharge Time..... 16 hours\*

\*Charging is done through USB , except when supplying loop power in mA, Int. Pwr. Mode.

### ► Battery Replacement

The HPC uses four AA batteries. Unscrew the two flathead screws to gain access to the battery compartment. Replace the batteries taking care to note polarity for their proper installation. Failure to properly seal the battery compartment may allow water damage that could permanently compromise the HPC40.

After installation, the HPC40 may prompt you to indicate the type of battery you installed. This is to ensure that non-rechargeable batteries are not damaged through charging when connected to the USB port.

### ► USB Power and Charging

The USB/power icon (  ) will be displayed when connected. The mini USB connection will power the HPC40 with or without batteries installed. If rechargeable batteries are installed and the appropriate battery type selection has been made, it will also recharge the batteries.

## RANGES AND RESOLUTIONS

psi	bar	kPa/MPa	Overpressure	psi	kg/cm2	inHg	inH2O	mmHg	mmH2O	kPa	bar	mbar	MPa
30PSI	3BAR		3.0 x	0.001	0.0001	0.001	0.01	0.01	1	0.01	0.0001	0.1	
			3.0 x	0.001	0.0001	0.001	0.01	0.01	1	0.01	0.0001	0.1	
	300KPA	3.0 x							0.01	0.0001	0.1		
100PSI	10BAR		2.0 x	0.001	0.0001	0.01	0.1	0.1	1	0.01	0.0001	0.1	0.00001
			2.0 x	0.001	0.0001	0.01	0.1	0.1	1	0.01	0.0001	0.1	0.00001
300PSI	30BAR		2.0 x	0.01	0.001	0.01	0.1	0.1		0.1	0.001	1	0.0001
			2.0 x	0.01	0.001	0.01	0.1	0.1		0.1	0.001	1	0.0001
	3MPA	2.0 x							0.1	0.001	1	0.0001	
1KPSI	100BAR		2.0 x	0.01	0.001	0.1				0.1	0.001		0.0001
			2.0 x	0.01	0.001	0.1				0.1	0.001		0.0001
	10MPA	2.0 x							0.1	0.001		0.0001	
3KPSI	300BAR		1.5 x	0.1	0.01	0.1				1	0.01		0.001
			1.5 x	0.1	0.01	0.1				1	0.01		0.001
	30MPA	1.5 x							1	0.01		0.001	
10KPSI	700BAR		1.5 x	0.1	0.01					1	0.01		0.001
			1.5 x	0.1	0.01					1	0.01		0.001
	70MPA	1.5 x							1	0.01		0.001	
15KPSI	1000BAR		1.3 x	0.1	0.01					1	0.01		0.001
			1.3 x	0.1	0.01					1	0.01		0.001
	100MPA	1.3 x							1	0.01		0.001	

### ► Ordering Information

Number of Sensors	1st Pressure Range P/N	2nd Pressure Range P/N	BARO Option	Adapter
HPC41 ... (Single)			No .... (omit)	1/4 NPT .... (omit)
HPC42 .... (Dual)			Yes... -BARO	G 1/4 B. .... -BSP
				M20x1.5 ... -M20

#### SAMPLE PART NUMBERS

HPC41-1KPSI ..... Single Sensor (1000 psi) HPC40 with a 1/4" NPT pressure fitting.

HPC42-3BAR-700BAR-BSP-BARO ..... Dual Sensor (3 bar/700 bar) HPC40 with a 1/4" BSP pressure fitting and BARO option.

## CERTIFICATIONS

The HPC40 Series has been tested and certified to comply with a variety of international standards.



We declare that the HPC40 is in accordance with the Electromagnetic Compatibility Directive, and the Pressure Equipment Directive per our declaration(s).



This HPC40 Series complies with the Australian Radiocommunications (Electromagnetic Compatibility) Standard 2008.

# Support

## TROUBLESHOOTING

---

The HPC40 Series is a very high performance calibrator. Due to the high resolution of this product, you may observe conditions that appear to be defects in the product, but are in fact a result of being able to read and measure pressure to a degree not possible with other instruments.

### Noisy or unstable reading when used with fluids

When calibrating or comparing the indicated pressure from an HPC40 against a hydraulic deadweight tester or piston gauge, the reading on the HPC40 may appear unstable—the least significant digit jumps up and down several counts.

► **Reason**

Gas (usually air) is trapped in the line between the HPC40 and the deadweight tester. What is actually happening is the mass is oscillating up and down, and the combination of gas and fluid is acting like a spring. At higher pressures (above 2000 psi, typically) this may eventually diminish, as the gas dissolves into the fluid.

► **Solution**

Evacuate all tubing with a vacuum pump before introducing fluid into the system.

---

### Non-repeatability of pressure measurements

When checking the calibrator against a hydraulic deadweight, increasing pressure measurements do not match decreasing pressure measurements.

► **Reason**

As in the previous note, gas has dissolved into the hydraulic fluid. When decreasing the pressure, the dissolved gas then leaves the fluid, but at an uneven rate, so a small pressure differential (due to fluid head pressure) may exist between the reference deadweight and the gauge being tested.

► **Solution**

Evacuate all tubing with a vacuum pump before introducing fluid into the system.

---

### Slow return to zero and/or non-repeatability of pressure measurements

► **Reason**

Pressure port is obstructed.

► **Solution**

Clean with low pressure fluid. Do not touch diaphragm as damage will result.

## CALIBRATION

---

If adjustment is required, we recommend returning the HPC40 to the factory. Factory service offers benefits you won't find anywhere else. Factory calibration tests your HPC40 at a variety of temperatures utilizing NIST traceable standards, resulting in calibration certificates that provide performance data over temperature. Our calibration facilities are A2LA accredited (cert #2601.01) to ISO 17025:2005 & ANSI/NC SL Z540-1-1994. A2LA is internationally recognized as an accreditation body by the International Laboratory Accreditation Cooperation, ILAC. Furthermore, upgrades may be available to add or enhance operating features. We designed the product to last, and we support it so that you can get the most from your investment.

Under normal operating conditions, we recommend the HPC40 be calibrated on an annual basis. Your quality system may require more or less frequent calibration, or your experience with the gauge, or operating environment may suggest longer or shorter intervals.

Although we prefer that you return the HPC40 to us for calibration, ordinary recertification and/or adjustments may be performed by any qualified personnel with appropriate training and equipment. The following instructions are ONLY intended for such qualified personnel with appropriate test equipment. We recommend that the calibration standards used have a minimum rated accuracy of 0.008% of reading, or equivalent in terms of percent of full scale. This level of accuracy requires the use of piston (deadweight) gauges or very high performance pressure controllers.

**CRYSTALCONTROL** There are no internal potentiometers. Each of the HPC40's sensors has a "span factor" (userspan), set to approximately 1 (as shipped from the factory). As components age this may need to be changed to a value slightly higher or lower, to slightly increase or decrease all readings. This adjustment can be made with a computer through CrystalControl.

---

### Calibration of P1 and P2

**CRYSTALCONTROL** "Zero" the HPC40, then record displayed pressure for two or more pressure points. Determine if the HPC40 would benefit from an overall increase or decrease of the indicated pressures. Adjust userspan accordingly and validate results.

---

### Calibration for Barometric Reference Module (BARO)

**CRYSTALCONTROL** The BARO module can be calibrated by selecting the Edit Calibration Data button while within the BARO Config screen. Enter Userspan and Offset information directly, or you can use the Calibration Wizard to calculate the optimum values for a 1 or 2 point calibration.

- 1 Remove the mounting bracket on the back of the HPC 40, exposing the barometric sensor port.
- 2 Connect a flexible 4.8 mm [3/16"] ID tubing from your clean pneumatic calibration reference to the BARO sensor.  
You can also order the BARO calibration kit (P/N 4547), which includes the tubing.

- ! **CAUTION:** Do not subject the BARO sensor to pressures less than 700 mbarA (10.153 PSIA), or greater than 1100 mbarA (15.954 PSIA), as this may cause permanent damage. Use only clean a clean dry pneumatic source.
- ! **CAUTION:** Direct contact with the surface of the BARO sensor may cause permanent damage. Direct sunlight on exposed BARO sensor may affect readings slightly.

---

## Calibration of V and mA In

**CRYSTALCONTROL** Compare the reading on the HPC40 and determine if the HPC40 would benefit from an overall increase or decrease of the Voltage or Milliamp. Adjust the userspan accordingly and validate results.

---

## Calibration of mA Out

**CRYSTALCONTROL** Compare the sourced mA reading and determine if the HPC40 would benefit from an overall increase or decrease. Adjust the userspan accordingly and validate results.

---

## Calibration of RTD

**CRYSTALCONTROL** Press the settings button and select RTD In. Arrow down to the R0 section and change the value to 0 (the default is 100). Go back to the main screen and set the mode to RTD In, the RTD type to Customer RTD, and the number of wires to 4 Wire. Apply resistance in ohms with a 4-wire configuration. Determine if the HPC40 would benefit from an overall increase or decrease. Adjust the userspan accordingly and validate results.

---

## ACCESSORIES AND REPLACEMENT PARTS

### **P/N 104203 Test Lead Kit**

Lead Kit, Red and black test leads with clips. (Included as standard)

### **P/N 5241 Protective Boot**

Skydrol™ resistant protective boot. (Included as standard)

### **P/N 3951 Mini-USB Cable**

The durable and high-speed Micro-USB cable enables data transfer in the most convenient form. (Included as standard)

### **P/N 3009 Hard Carrying Case**

Aluminum carrying case with molded eggshell foam interior.

### **P/N 2888 Waterproof Carrying Case**

Hard plastic carrying case with molded eggshell foam interior.

### **P/N 127387 RTD Probe**

Pt100 Probe with 4-pol LEMO .

### **P/N 124716 4AA Rechargeable Batteries**

Package of 4.

### **MPM-1/4MPT CPF Male to 1/4" Male NPT Fitting**

(Included as standard)

### **MPM-1/4BSPM CPF Male to 1/4" Male BSP Fitting**

(Included with -BSP)

### **MPM-M20x1.5M CPF Male to M20 Male Adapter**

(Included with -M20)



## CONTACT US

### USA

**Crystal Engineering** • California\*  
Tel +1 (800) 444 1850  
Fax +1 (805) 595 5466  
[crystal@ametek.com](mailto:crystal@ametek.com)

**Mansfield & Green** • Florida  
Tel +1 (800) 527 9999  
[cal.info@ametek.com](mailto:cal.info@ametek.com)

### United Kingdom

Tel +44 (0)1243 833 302  
[jofra@ametek.co.uk](mailto:jofra@ametek.co.uk)

### France

Tel +33 (0)1 30 68 89 40  
[general.lloyd-instruments@ametek.fr](mailto:general.lloyd-instruments@ametek.fr)

### Germany\*\*

Tel +49 (0)2159 9136 510  
[info.mct-de@ametek.de](mailto:info.mct-de@ametek.de)

### Denmark\*\*\*

Tel +45 4816 8000  
[jofra@ametek.com](mailto:jofra@ametek.com)

### India

Tel +91 22 2836 4750  
[jofra@ametek.com](mailto:jofra@ametek.com)

### Singapore

Tel +65 6484 2388  
[jofra@ametek.com](mailto:jofra@ametek.com)

### China

Shanghai  
Tel +86 21 5868 5111

Beijing  
Tel +86 10 8526 2111

Guangzhou  
Tel +86 20 8363 4768  
[jofra.sales@ametek.com.cn](mailto:jofra.sales@ametek.com.cn)

\*ISO 17025 accredited calibration lab, (A2LA #2601.01).

\*\*DIN EN ISO / IEC 17025 accredited calibration lab.

\*\*\*DANAK EN ISO/IEC 17025 accredited calibration lab.

If calling, have ready the model number, serial number, date of purchase, and reason for return. You will receive instructions for returning the device to us.

## WARRANTY

Crystal Engineering Corporation warrants the HPC40 Series Calibrator to be free from defects in material and workmanship under normal use and service for one (1) year from date of purchase to the original purchaser. It does not apply to batteries or when the product has been misused, altered or damaged by accident or abnormal conditions of operation.

Crystal Engineering will, at our option, repair or replace the defective device free of charge and the device will be returned, transportation prepaid. However, if we determine the failure was caused by misuse, alteration, accident or abnormal condition of operation, you will be billed for the repair.

CRYSTAL ENGINEERING CORPORATION MAKES NO WARRANTY OTHER THAN THE LIMITED WARRANTY STATED ABOVE. ALL WARRANTIES, INCLUDING IMPLIED WARRANTIES OF MERCHANTABILITY OR FITNESS FOR ANY PARTICULAR PURPOSE, ARE LIMITED TO A PERIOD OF ONE (1) YEAR FROM THE DATE OF PURCHASE. CRYSTAL ENGINEERING SHALL NOT BE LIABLE FOR ANY SPECIAL, INCIDENTAL OR CONSEQUENTIAL DAMAGES, WHETHER IN CONTRACT, TORT OR OTHERWISE.

**Note: (USA only) Some states do not allow limitations of implied warranties or the exclusion of incidental or consequential damages, so the above limitations or exclusions may not apply to you. This warranty gives you specific legal rights and you may have other rights which vary from state to state.**



© 2021 Crystal Engineering Corporation

708 Fiero Lane, Suite 9, San Luis Obispo, California 93401-8701

---

