



Model **M7I**

DIGITAL FORCE / TORQUE INDICATOR

User's Guide

MARK-10

Thank you...



Thank you for purchasing a Mark-10 Model M71 force/torque indicator, designed for use with interchangeable remote force and torque sensors. An M71+sensor combination can be used with some Mark-10 test stands, grips, and data collection software.

With proper usage, we are confident that you will get many years of great service with this product. Mark-10 instruments are ruggedly built for many years of service in laboratory and industrial environments.

This User's Guide provides setup, safety, and operation instructions. Dimensions and specifications are also provided. For additional information or answers to your questions, please do not hesitate to contact us. Our technical support and engineering teams are eager to assist you.

Before use, each person who is to use the M71 should be fully trained in appropriate operation and safety procedures.

TABLE OF CONTENTS

OVERVIEW.....2

POWER.....4

SETUP5

HOME SCREEN AND CONTROLS7

DIGITAL FILTERS.....9

SET POINTS..... 10

BREAK DETECTION..... 11

OPERATING MODES..... 13

DATA MEMORY AND STATISTICS 21

FOOTSWITCH 23

COEFFICIENT OF FRICTION 24

CUSTOM UNIT 24

COMMUNICATIONS AND OUTPUTS 25

CALIBRATION 31

PASSWORDS..... 37

OTHER SETTINGS..... 39

SPECIFICATIONS 41

1 OVERVIEW

1.1 List of included items

Qty.	Part No.	Description
1	12-1049	Carrying Case
1	08-1022	AC adapter body with US, EU, or UK prong
1	08-1026	Battery (inside the indicator)
1	-	Certificate of conformance
1	09-1165	USB cable
-	USB driver, MESUR® Lite software, MESUR®gauge evaluation software, User's Guide Download at: www.mark-10.com/resources	

1.2 General Overview



From left to right: Model M5I indicator with Series R01 force sensor, Model M3I indicator with Series R02 force sensor, and Model M7I indicator with Series R50 torque sensor

The M7I is a universal indicator designed for displaying measurements from interchangeable Mark-10 Plug & Test® sensors. Sensor capacities are available from 0.25 to 10,000 lbf (1 N to 50 kN) of force, and from 10 ozFin to 5,000 lbFin (7 Ncm to 550 Nm) of torque. These sensors can be handheld or mounted to a fixture or test stand for more sophisticated testing requirements.

Plug & Test® sensors are used with either the M7I, M5I, or M3I indicators. They may be disconnected from one indicator and connected to another without the need for re-calibration or re-configuration. All such data is saved within a PCB located inside the smart connector.

The model number, serial number, and capacity of the sensor are identified in the rectangular label located on the Plug & Test® connector. The model and serial numbers are also identified in the **Information** screen of the indicator.

1.3 Accuracy and Resolution

Indicator accuracy must be combined with sensor accuracy to determine the total accuracy of the system. Since sensors may be used with either the M7I, M5I or M3I indicator, the accuracy of the indicator being used must be identified and taken into account, as follows:

Indicator Model	Accuracy
M7I / M5I	±0.1% of full scale
M3I	±0.2% of full scale

The total system accuracy can be calculated by adding the sensor accuracy and indicator accuracy. Refer to the following examples:

Example 1

Model MR01-100 sensor with Model M7I Indicator

MR01-100 ±0.15% of full scale	+	M7I ±0.1% of full scale	=	Total ±0.25% of full scale
---	---	-----------------------------------	---	--------------------------------------

This translates into a fixed error of up to:
 $0.25\% \times 100 \text{ lbF} = 0.25 \text{ lbF}$

Example 2

Model MR50-50Z sensor with Model M3I Indicator

MR50-50Z ±0.35% of full scale	+	M3I ±0.2% of full scale	=	Total ±0.55% of full scale
---	---	-----------------------------------	---	--------------------------------------

This translates into a fixed error of up to:
 $0.55\% \times 50 \text{ ozF} = 0.275 \text{ ozF}$

Because accuracy is defined as a *percentage of full scale*, the fixed error is possible anywhere on the scale from 0 to the capacity. As such, this value represents an increasingly large error as *percentage of reading* towards the low end of the scale. It is, therefore, recommended that a sensor is selected with capacity as close as possible to the expected load.

The resolution may be different for some sensors depending on whether an M7I, M5I, or M3I indicator is being used. For example, a Series R01 force sensor will display finer resolution when connected to an M7I indicator than when connected to a M3I indicator. Resolution information is shown in the sensors' user's guide.

1.4 Safety / Proper Usage

Read through the following safety instructions thoroughly before using the M7I with a sensor:

1. Note the sensor's capacity before use and ensure that the capacity is not exceeded. Producing a load greater than the indicated safe overload value can damage the sensor. An overload can occur whether the indicator is powered on or off.
2. In order to extend the life of the sensor, avoid repetitive shock and impact loading.
3. When moving the sensor to another location, never lift from the cable or strain relief. This can cause damage to the sensor. Always lift the sensor housing itself.
4. Always ensure that load is applied axially with respect to the sensor.
5. Ensure that the sensor is kept away from water or any other electrically conductive liquids at all times.
6. The sensor and indicator should be serviced by a trained technician only. AC power must be disconnected and the indicator must be powered off before the housing is opened.
7. Always consider the characteristics of the sample being tested before initiating a test. A risk assessment should be carried out beforehand to ensure that all safety measures have been addressed and implemented.

8. Typical materials able to be tested include many manufactured items, such as springs, electronic components, fasteners, caps, films, mechanical assemblies, and many others. Items that should not be used with the sensor include potentially flammable substances or products, items that can shatter in an unsafe manner, and any other components that can present an exceedingly hazardous situation when acted upon by a load. Always wear eye and face protection when testing, especially in aforementioned hazardous cases. Extra bodily protection should be worn if a destructive failure of a test sample is possible.
9. In aforementioned hazardous situations, it is strongly recommended that a machine guarding system be employed to protect the operator and others in the vicinity from shards or debris.
10. Sensors have threaded holes or chucks, designed for the mounting of grips, fixtures, or attachments. If any such accessories are used, ensure they are mounted firmly to prevent a potential safety risk to the operator and others in the vicinity. If using an accessory from a supplier other than Mark-10, ensure that it is constructed of suitably rugged materials and components. Similar precautions should be taken when mounting the sensor to a test stand, work bench, or other piece of equipment.

2 POWER

The M7I is powered either by an 8.4V NiMH rechargeable battery or by an AC adapter. Since the batteries are subject to self discharge, it may be necessary to recharge the unit after a prolonged period of storage. Plug the accompanying charger into the AC outlet and insert the charger plug into the receptacle on the indicator (refer to the illustration below). The battery will fully charge in approximately 8 hours.







Caution!

Do not use chargers or batteries other than supplied or instrument damage may occur.

If the AC adapter is plugged in, an icon appears in the lower left corner of the display, as follows: 

If the AC adapter is not plugged in, battery power drainage is denoted in a five-step process:

1. When battery life is greater than 75%, the following indicator is present: 
2. When battery life is between 50% and 75%, the following indicator is present: 
3. When battery life is between 25% and 50%, the following indicator is present: 
4. When battery life is less than 25%, the following indicator is present: 
5. When battery life drops to approximately 2%, the indicator from step 4 will be flashing. Several minutes after (timing depends on usage and whether the backlight is turned on or

off), a message appears, "BATTERY VOLTAGE TOO LOW. POWERING OFF". An audio tone will sound and the indicator will power off.

The indicator can be configured to automatically power off following a period of inactivity. Refer to the **Other Settings** section for details.

If battery replacement is necessary, it can be accessed by separating the two halves of the indicator. Refer to the **Setup** section for details.

3 SETUP

3.1 Connecting a sensor

The Plug & Test[®] connector must be inserted into the receptacle of the M7I, M5I, or M3I indicator with the side marked "Plug & Test[®] Technology" facing up (see Fig. 3.1). When fully inserted, the connector will lock into place with a "click".



Fig. 3.1
Appropriate orientation of Plug & Test[®] connector. Sensor model number, serial number, and load capacity may be found on the labels affixed to the connector.

To release the connector, press both buttons on either side of the indicator housing to release the sensor (see Fig. 3.2). Pull the connector completely out of the indicator by holding the curved aluminum section. **DO NOT** pull on the cable or strain relief.



Fig. 3.2
Press both buttons on either side of the indicator housing to release the Plug & Test[™] connector.

3.2 Sensor connector orientation

In order to accommodate a variety of testing requirements, the orientation of the Plug & Test[®] connector may be set up in either of the two positions shown below. To change the orientation, loosen the two captive screws on the back side of the housing, separate the two housing halves, rotate one half 180 degrees, and reassemble. Contact between the two halves is made by the spring pins and contact pads on the printed circuit boards.



Sensor connector
oriented up



Sensor connector
oriented down

3.3 Mounting to a plate

The M7I can be mounted to a plate with four thumb screws fastened into the appropriate holes in the rear half of the housing. Refer to the **Dimensions** section for detailed hole information and locations.

3.4 Installing the USB driver

If communicating via USB, install the USB driver available at: www.mark-10.com/resources

Caution!

Install the USB driver before physically connecting the indicator to a PC with the USB cable.

Further instructions for configuring and using the indicator's outputs are provided in the **Communications and Outputs** section.

4 HOME SCREEN AND CONTROLS

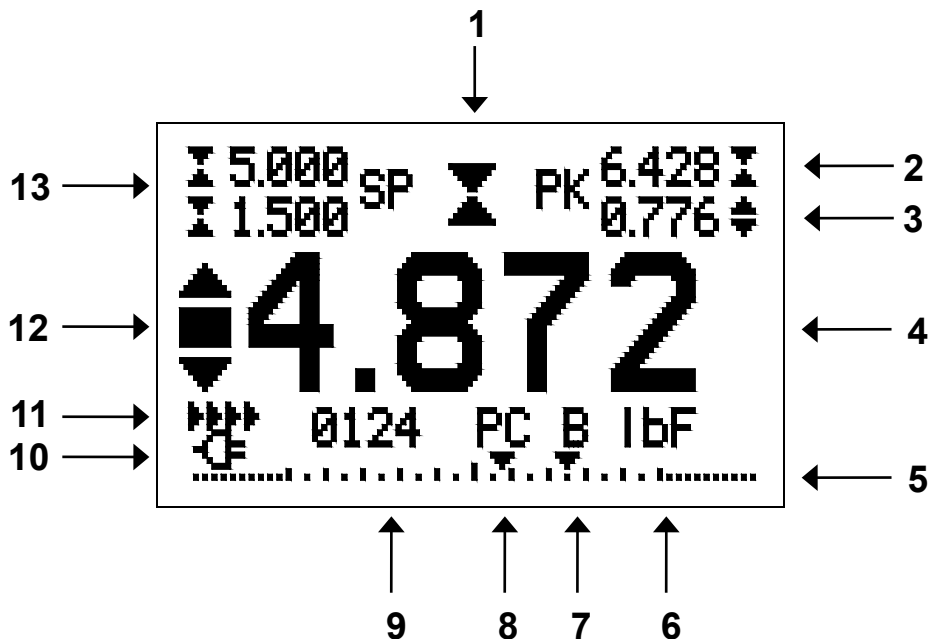

4.1 Home Screen





No.	Name	Description
1	Measurement direction indicator	<ul style="list-style-type: none"> ⏏ – indicates compression direction (for force sensors) ⏏ – indicates tension direction (for force sensors) ⏏ – indicates clockwise direction (for torque sensors) ⏏ – indicates counter-clockwise direction (for torque sensors) These indicators are used throughout the display and menu.
2	Compression / Clockwise peak	The maximum measured compression or clockwise value. This value may be reset by pressing ZERO or by powering the indicator off and on.
3	Tension / Clockwise peak / Static COF	The maximum measured tension or counter-clockwise value. If the COF unit is selected, this represents the static coefficient of friction. May be reset by pressing ZERO or by powering the indicator off and on.
4	Primary reading / Kinetic COF	The current displayed load reading. When the COF unit is selected, this reading represents the kinetic coefficient of friction upon completion of an Averaging sequence. See Operating Modes section for details. If a sensor is not plugged in, this value will be replaced by a message, as follows: SENSOR NOT CONNECTED
5	Load bar	Analog indicator to help identify when an overload condition is imminent. The bar increases either to the right or to the left from the midpoint of the graph. Increasing to the right indicates compression or clockwise load, increasing to the left indicates tension or counter-clockwise load. If set points are enabled, triangular markers are displayed for visual convenience. This indicator reflects the actual load, which may not correspond to the primary reading (depends on operating mode). The ZERO key does not reset the load bar. See Operating Modes section for details.
6	Units	The current measurement unit. Abbreviations are as follows: Force units: lbF – Pound-force ozF – Ounce-force kgF – Kilogram-force gF – Gram-force





		<p>N – Newton kN – Kilonewton mN – Millinewton</p> <p>Torque units: lbFft – Pound-foot lbFin – Pound-inch ozFin – Ounce-inch kgFm – Kilogram-meter kgFmm – Kilogram-millimeter gFcm – Gram-centimeter Nm – Newton-meter Ncm – Newton-centimeter Nmm – Newton-millimeter</p> <p>Note: not all sensor models display all the above units. Refer to the capacity / resolution table for the respective sensor series for details.</p>
7	Break Detection On/Off	The letter “B” appears if the Break Detection function is enabled. Refer to the Break Detection section for details.
8	Mode	<p>The current measurement mode. Abbreviations are as follows:</p> <p>RT – Real Time PC – Peak Compression (for force sensors) PT – Peak Tension (for force sensors) PCW – Peak Clockwise (for torque sensors) PCCW – Peak Counter-clockwise (for torque sensors) A – Average Mode ET – External Trigger Mode</p> <p>See Operating Modes section for details about each of these modes</p>
9	Number of stored data points	The number of stored data points in memory, up to 5,000. Displayed only if Memory Storage or Data Capture functions are used.
10	Battery / AC adapter indicator	Either the AC adapter icon or battery power icon will be shown, depending on power conditions. Refer to the Power section for details.
11	Automatic data output indicator	If Auto Output has been enabled under Serial / USB Settings , this indicator is displayed. When automatic data output is occurring, the icon becomes animated. See Communications section for details.
12	High / low limit indicators	<p>Correspond to the programmed set points. Indicator definitions are as follows:</p> <p>▲ – the displayed value is greater than the upper load limit ■ – the displayed value is between the load limits ▼ – the displayed value is less than the lower load limit</p>
13	Set points	The programmed load limit values. Typically used for pass/fail type testing. One, two, or no indicators may be present, depending on the configuration shown in the Set Points menu item.

4.2 Controls



Primary Label	Primary Function	Secondary Label	Secondary Function
	Powers the indicator on and off. Press briefly to power on, press and hold to power off. Active only when the home screen is displayed.	ENTER	Various uses, as described in the following sections.
ZERO	Zeroes the primary reading and peaks.	 (UP)	Navigates up through the menu and sub-menus.
MENU	Enters the main menu.	ESCAPE	Reverts one step backwards through the menu hierarchy.

MODE	Toggles between measurement modes.	 (DOWN)	Navigates down through the menu and sub-menus.
DATA	Stores a value to memory, transmits the current reading to an external device, and/or initiates automatic data output, depending on setup.	DELETE 	Enables and disables Delete mode while viewing stored data / shifts cursor to the right for certain functions.
UNITS	Toggles between measurement units.	DIRECTION	Reverses the display during calibration, and toggles between measurement directions while configuring set points and other menu items.
	Turns the LCD backlight on and off.	N/A	N/A

4.3 Menu navigation basics

Most of the indicator's various functions and parameters are configured through the main menu. To access the menu press **MENU**. Use the  and  keys to scroll through the items. The current selection is denoted with clear text over a dark background. Press **ENTER** to select a menu item, then use  and  again to scroll through the sub-menus. Press **ENTER** again to select the sub-menu item.

For parameters that may be either selected or deselected, press **ENTER** to toggle between selecting and deselecting. An asterisk (*) to the left of the parameter label is used to indicate when the parameter has been selected.

For parameters requiring the input of a numerical value, use the  and  keys to increment or decrement the value. Press and hold either key to auto-increment at a gradually increasing rate. When the desired value has been reached, press **ENTER** to save the change and revert back to the sub-menu item, or press **ESCAPE** to revert back to the sub-menu item without saving. Press **ESCAPE** to revert one step back in the menu hierarchy until back into normal operating mode.

Refer to the following sections for details about setting up particular functions and parameters.

5 DIGITAL FILTERS

Digital filters are provided to help smooth out the readings in situations where there is mechanical interference in the work area or test sample. These filters utilize the moving average technique in which consecutive readings are pushed through a buffer and the displayed reading is the average of the buffer contents. By varying the length of the buffer, a variable smoothing effect can be achieved. The selection of 1 will disable the filter since the average of a single value is the value itself.

To access digital filter settings, select **Filters** from the menu. The display appears as follows:

DIGITAL FILTERS (1 = Fastest)
Current Reading 1
Displayed Reading 1

Two filters are available:

Current Reading – Applies to the peak capture rate of the instrument.

Displayed Reading – Applies to the primary reading on the display.

Available settings: 1, 2, 4, 8, 16, 32, 64, 128, 256, 512, 1024, 2048, 4096, 8192. It is recommended to keep the current reading filter at its lowest value for best performance, and the displayed reading filter at its highest value for best visual stability.

6 SET POINTS

6.1 General Information

Set points are useful for tolerance checking (pass/fail), triggering an external device such as a motorized test stand, or alarm indication in process control applications. Two limits, high and low, are specified and stored in the non-volatile memory of the instrument and the primary reading is compared to these limits. The results of the comparisons are indicated through the three outputs provided on the 15-pin connector, thus providing “under”, “in range”, and “over” signaling. These outputs can be connected to indicators, buzzers, or relays as required for the application.

6.2 Configuration

To configure set points, select **Set Points** from the menu. The screen appears as follows:

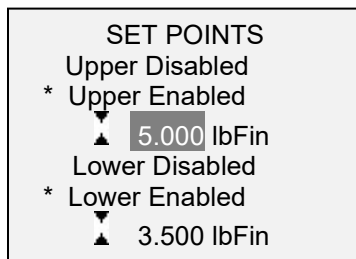

Either one, two, or none of the set points may be enabled. To toggle between measurement directions, press the **DIRECTION** key.

If two set points have been enabled, they are displayed in the upper left corner of the display. If only one set point has been enabled, the word “OFF” appears in place of the value. If no set points have been enabled, the upper left corner of the display will be blank.

When set points are enabled, the following indicators are shown to the left of the primary reading:

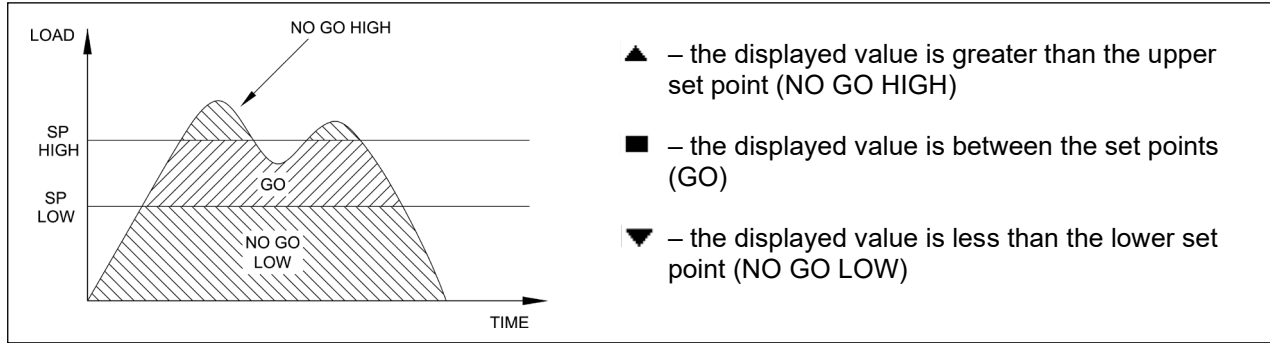

Note: Set point indicators and outputs reference the displayed reading, not necessarily the current live load.

6.3 Set Point Outputs Schematic Diagram

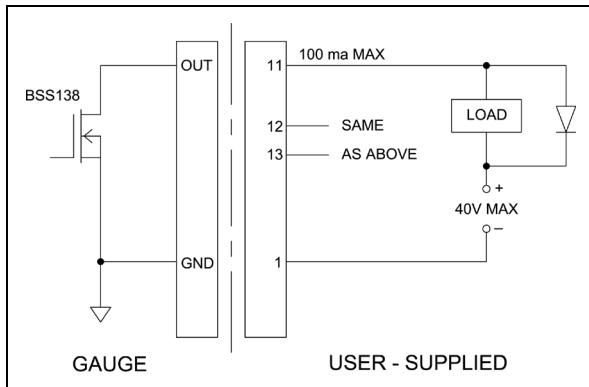

6.4 Using Set Points to Control a Mark-10 Motorized Test Stand

When using set points to stop/cycle Mark-10 motorized test stands, the upper and lower set points must be set to **opposite** measuring directions. **Both** set points must be set, even if the intended application is to stop/cycle at only one of the set points. The opposite set point should be a value sufficiently large that it does not get triggered during the course of the test.

For certain Mark-10 test stands, the upper and lower set point directions are reversed.

7 BREAK DETECTION

The break detection function identifies when a sample has broken, clicked, slipped, or otherwise reached a peak load and then fell by a specified percentage drop. Upon detection of the break, the indicator can perform several automatic functions, depending on the mode in which break detection is enabled, as follows:

1. Transmit the peak reading (Auto Output).
2. Save the peak value to memory (Auto Storage).
3. Zero the primary and peak readings (Auto Zero).
4. Toggle a pin (for example, to stop crosshead movement on a Mark-10 motorized test stand).

Break detection functions and settings are configured from a central location, and apply to any mode in which it is enabled. Refer to the **Operating Modes** section for details on configuring each mode.

7.1 Configuration

To enable Break Detection and configure the automatic functions, select **Break Detection** from the main menu. The display appears as follows:

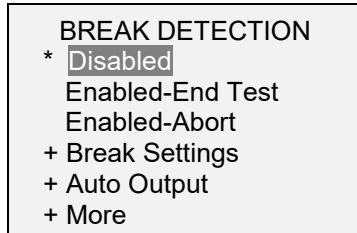

Select "+ More" for additional options:

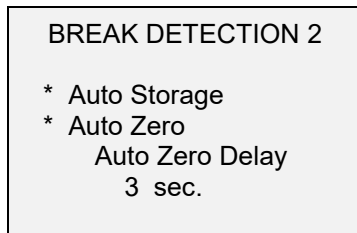

Any combination of the above functions may be selected.

Function	Description
Enabled-End Test	Arms the break detection function. When enabled, the letter "B" appears on the home screen, between the Mode and Unit indicators. Refer to the Home Screen and Controls section for details. Applies to modes in which a <i>Break Detect Stop Condition</i> is specified.
Enabled-Abort	Same as above, except applies to situations in which a premature break occurs before the specified <i>Stop Condition</i> is reached.
Break Settings	Refer to the following sub-sections for details.
Auto Output	
Auto Storage	Automatically stores the peak reading to memory.
Auto Zero	Automatically zeroes the display following data transmission and/or storage.

If tones are enabled, a tone will sound when the output, storage, and zero functions have occurred.

7.2 Break Settings

Select **Break Settings** from the main menu to configure the settings. The display appears as follows:

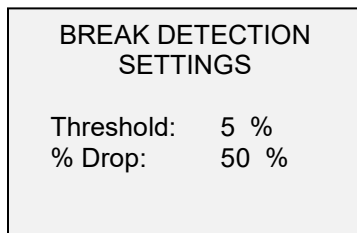

Threshold	Sets the percentage of full scale at which the break detection function becomes active. This threshold is provided to ignore peaks that can occur during sample loading and unloading. Available settings: <i>1–90%, in 1% increments until 5%, 5% increments thereafter.</i>
% Drop	Sets the percentage drop from the peak reading at which the break is detected. Available settings: <i>5%–90% of peak, in 5% increments.</i>
Auto Zero Delay	Sets the time delay before the primary and peak readings are zeroed. Auto zero can be disabled if required. Refer to the Auto Output Settings sub-section for details. Available settings: <i>1–10 sec., in 1 sec. increments, and 10–60 sec., in 5 sec. increments.</i>

Note:

When using a Series 7 gauge with an ESM303, ESM303H, or ESM1500 equipped with **Break Detection**, enable the function in either the test stand or the instrument. The function will not work if simultaneously enabled in both devices.

7.3 Auto Output Settings

Scroll to **Auto Settings** in the **Break Detection** menu and press **ENTER** to configure the auto output settings. Any combination may be selected. The display appears as follows:

AUTO OUTPUT SETTINGS RS232/USB Output Mitutoyo Output Output Pin: NONE
--

Parameter	Description
RS232/USB Output	Automatically output the peak when the break (% drop) is detected.
Mitutoyo Output	Automatically output the peak when the break (% drop) is detected.
Output Pin	Automatically toggle the SP1, SP2, or SP3 pins (active low). If not required, select "NONE". To stop most Mark-10 motorized test stands when a break occurs, specify SP2 if the break is in the tension/counter-clockwise direction, or SP1 for the compression/clockwise direction. Note: Because the same pins are also used for set points, the stand will stop at whichever condition occurs first.

8 OPERATING MODES**Caution!**

In any operating mode, if the capacity of the instrument has been exceeded by more than 110%, the display will show "OVER" to indicate an overload. A continuous audible tone will be sounded until the MENU key has been pressed or the load has been reduced to a safe level.

Several operating modes are possible with the M7I, depending on whether force or torque sensors are used, as follows:

- **Real Time (RT)**
- **Peak Compression (PC) or Peak Clockwise (PCW)**
- **Peak Tension / Static COF (PT) or Peak Counter-clockwise (PCCW)**
- **Average Mode / Kinetic Coefficient of Friction (AVG)**

- **External Trigger (ET)**
- **Data Capture (CAPT)**
- **1st/2nd Peak (2PK)**

To cycle between the modes, press **MODE** while in the home screen. Refer to the following sections for details for each mode:

8.1 Real Time (RT)

The primary reading corresponds to the live measured reading.

8.2 Peak Compression (PC) / Peak Clockwise (PCW)

The primary reading corresponds to the peak compression or peak clockwise reading observed. If the actual load decreases from the peak value, the peak will still be retained in the primary reading area of the display. Pressing **ZERO** will reset the value.

8.3 Peak Tension / Static Coefficient of Friction (PT) / Peak Counter-clockwise (PCCW)

This is the same as Peak Compression, but for tension or counter-clockwise readings. If the COF unit is selected, the reading in this mode represents the static coefficient of friction.

Note: The static COF is always displayed as the peak tension value in the upper right corner of the display.

8.4 Average Mode / Kinetic Coefficient of Friction (AVG)

Average mode is used to obtain an average load over time. This reading also represents the kinetic coefficient of friction, if the COF unit is selected. Applications include measurement of peel force, COF, muscle strength, frictional force or torque, and other tests requiring time-averaged readings.

Before the parameters of Average Mode can be configured, it must be enabled. To do so, select **Average Mode** from the menu, scroll to **Enabled** and press **ENTER**. The display appears as follows:

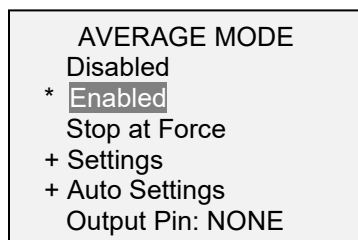

The averaging function operates in one of two ways:

1. Averaging occurs between the trigger load and defined time limit, as illustrated below:

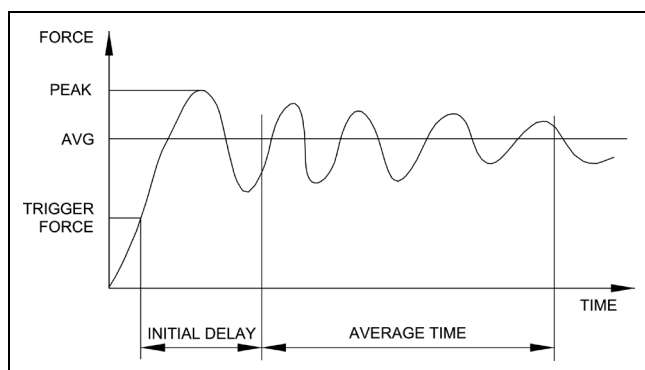

- Averaging occurs only while above the trigger load. As the load drops back down to this trigger, averaging stops. To enable this function, scroll to **Stop at Force** and press **ENTER**.

Select **Settings** to configure **Trigger Force**, **Initial Delay**, and **Averaging Time**:

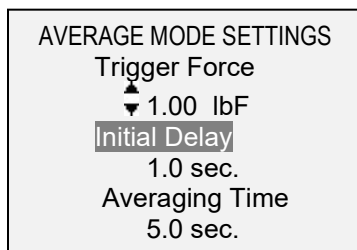

Parameter	Description
Trigger Force or Start / Stop Force	The minimum load required to start the averaging sequence. Toggle between load directions by pressing the DIRECTION key. Initial delay follows the trigger load. If Stop at Force is enabled, this parameter is referred to as Start / Stop Force , denoting the minimum load for which averaging will be active.
Initial Delay	The time delay, after the trigger load, before the averaging sequence commences. <i>Available settings: 0.0 – 300.0 sec., in 0.1 sec. increments</i>
Averaging Time	The time duration of the averaging sequence. This setting is ignored when Stop at Force is enabled, unless the 300 sec. limit is reached. <i>Available settings: 0.1 – 300.0 sec., in 0.1 sec. increments</i>

Upon completion of an averaging sequence, several automatic functions can occur, as configured in the **Auto Settings** section:



Parameter	Description
RS232/USB Output	Automatically output the average via RS-232 or USB at the completion of the averaging sequence.
Mitutoyo Output	Automatically output the average via Mitutoyo (Digimatic) at the completion of the averaging sequence.
Memory Storage	Automatically store the average at the completion of the averaging sequence.
Auto Zero	Automatically zero the reading at the completion of the averaging sequence. This re-arms the gauge for a new averaging sequence as if ZERO has been pressed.
Auto Zero Delay	The amount of time before the auto-zero occurs, in seconds: <i>Available settings: 1-10 sec., in 1 sec. increments, and 10-60 sec., in 5 sec. increments.</i>
Output Pin	Automatically toggle the SP1, SP2, or SP3 pins (active low). If not required, select "NONE". To stop a Mark-10 test stand when averaging is completed, specify SP2 if moving in the tension / counter-clockwise direction, or SP1 for the compression / clockwise direction. Note: Because the same pins are also used for set points, the stand will stop at whichever condition occurs first.

After the parameters have been configured and the menu has been exited, press **MODE** until **AVG** is displayed. Then press **ZERO**. Average mode is now armed, and the averaging sequence will commence when the trigger load has occurred. The current status of the averaging sequence is displayed below the primary reading, as follows:

Step	Status	Description
1	TRIG WAIT	The trigger load has not yet occurred.
2	INIT DLY	The initial delay is currently taking place.
3	AVERAGING	The gauge is collecting readings. The status will be flashing until averaging has been completed.
4	AVRG DONE	Averaging has been completed. The average load is displayed in the primary reading.

At the completion of the averaging sequence, the peak values are retained until **ZERO** is pressed. Another averaging sequence may be started after **ZERO** has been pressed (or auto-zeroed). To exit Average mode, press **MODE** and select the desired measuring mode.

9.5 External Trigger (ET)

This mode of operation is useful for measuring electrical contact activation force as well as synchronization of multiple instruments for a “snapshot” view of applied forces. It is possible to capture the reading with a normally open contact (high to low transition of the trigger signal) or a normally closed contact (low to high transition). Certain Mark-10 motorized test stands may be automatically stopped when an external trigger has occurred.

Before the parameters of External Trigger Mode can be configured, it must be enabled. To do so, access the main menu, select **External Trigger**, scroll to one of the four available options and press **ENTER**. The options are as follows:

EXTERNAL TRIGGER * Disabled Momentary Hi->Lo Momentary Lo->Hi Maintained High Maintained Low + More

Select “+ More” for additional options:

EXTERNAL TRIGGER 2 + Auto Settings Output Pin: NONE

Option	Description
Momentary High → Low	The display will freeze the captured reading until ZERO is pressed. Applies to a high to low transition of the trigger signal.
Momentary Low → High	The display will freeze the captured reading until ZERO is pressed. Applies to a low to high transition of the trigger signal.
Maintained High	The display will show the captured reading only for as long as a high signal is maintained.

Maintained Low	The display will show the captured reading only for as long as a low signal is maintained.
Auto Settings	Functions exactly as described in Section 5.4. These parameter values are shared between Averaging and External Trigger modes.
Output Pin	Automatically toggle the SP1, SP2, or SP3 pins (active low). If not required, select "NONE". To stop a Mark-10 test stand when an external trigger occurs, specify SP2 if moving in the tension/counter-clockwise direction, or SP1 for the compression/clockwise direction. Note: Because the same pins are also used for set points, the stand will stop at whichever condition occurs first.

After the parameters have been configured and the menu has been exited, press **MODE** until **ET** is displayed. External Trigger mode is now armed. Refer to the pin diagram in the **Communications and Outputs** section for connection information.

To exit External Trigger mode, press **MODE** and select the desired measuring mode.

9.5.1 External Trigger Schematic Diagram

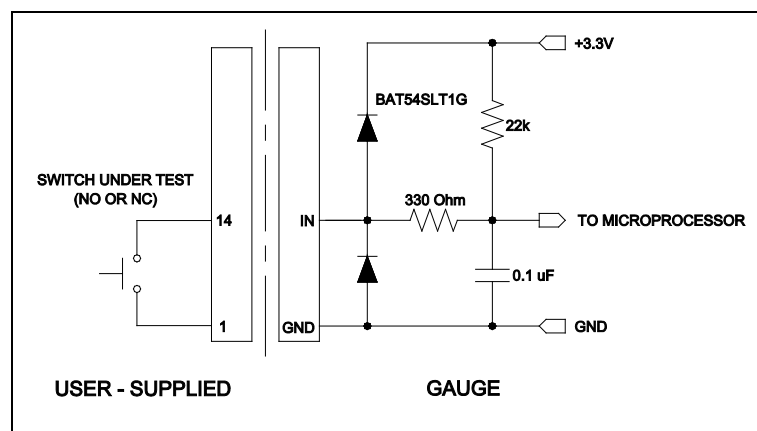

Note: Custom cabling is required to connect to a switch, or to connect a switch and a Mark-10 test stand simultaneously.

9.6 Data Capture (CAPT)

This mode of operation is used to capture and store continuous data in the indicator's memory. The capture frequency can be adjusted to accommodate quick-action as well as longer duration tests. Saved data can be downloaded in bulk via USB or RS-232.

9.6.1 Configuration

After Data Capture has been enabled, it may be selected by pressing the **MODE** key until **CAPT** is displayed. The display appears as follows:

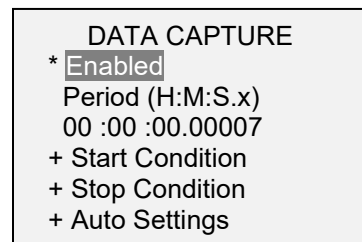

Function	Description
Enabled	If enabled, CAPT appears as one of the operating modes.
Period	The capture period may be adjusted by pressing the ▲ and ▼ keys to change the value of the hours (H), minutes (M), seconds (S), and fractions of seconds (x) fields. Press the ▶ key to advance to the next field. Available settings: <i>Hours: 0-24, Minutes: 0-59, Seconds: 0-59, Fraction of Seconds: 0.00007-0.99995, in 0.00007 (70 μS) increments.</i>
Start Condition	See following sub-sections for details.
Auto Settings	

Note: For best performance, it is recommended to keep the current reading filter at its lowest value. See **Digital Filters** section for details.

9.6.2 Start Condition

Data capture is initiated when the Start Condition has been triggered. Several triggers are available, as shown below:

<p>START CONDITION</p> <p>Momentary Hi→Lo Momentary Lo→Hi * Maintained High Maintained Low + More</p>

Select "+ More" for additional options:

<p>START CONDITION 2</p> <p>Start Load ▲ 3.500 lbFin * DATA Key</p>

Function	Data capture is initiated when:
Momentary Hi→Lo	An external trigger occurs. See External Trigger sub-section for details for each of these functions.
Momentary Lo→Hi	
Maintained High	
Maintained Low	
Start Load	The desired trigger load is reached. Toggle between measurement directions by pressing the DIRECTION key.
DATA Key	The DATA key is manually pressed.

9.6.3 Stop Condition

Data capture is automatically terminated when the Stop Condition has been reached. Several conditions are available, as shown below:

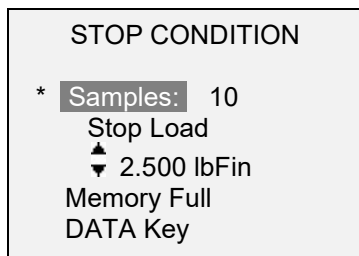

Function	Data capture terminates when:
Samples	The desired number of samples (data points) has been captured.
Stop Load	The desired load has been reached.
Memory Full	5,000 data points have been captured.
DATA Key	The DATA key is manually pressed.

When data capture has stopped, the data may be automatically transmitted in bulk to a PC application (not supported by Mark-10 data collection software). Data may also be transmitted manually through the **Memory** section.

Note 1: If the Stop Condition does not occur, data capture stops automatically when the memory is full.

Note 2: Data capture may be manually stopped at any time by pressing the **ZERO** key. A message appears at the bottom of the screen: "CAPTURE CANCELLED".

The first or subsequent Data Capture sequences cannot occur until the **ZERO** key is pressed to arm data capture, or until the gauge is automatically re-armed (see the following sub-section for details). If another Data Capture sequence is initiated before the memory is cleared, these data points are appended to the existing data stored in memory.

9.6.4 Auto Settings

The following functions can occur automatically upon termination of data capture:

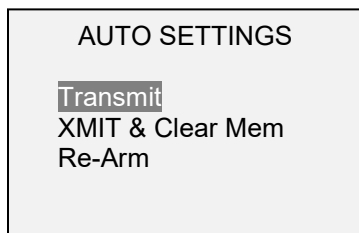

Function	Description
Transmit	Transmit all saved data via USB or RS-232.
XMIT & Clear Mem	Transmit all saved data via USB or RS-232, and clear the memory.
Re-Arm	Re-arm the indicator for the next Data Capture sequence.

9.7 First / Second Peak (2PK)

This function is designed to accurately capture first and second peaks which can occur in torque tool testing, materials testing and other applications.

9.7.1 Configuration

Several functions can be performed automatically upon detection of the second peak:

1. Transmit the first peak reading and/or...
2. Transmit the second peak reading and/or...
3. Save the first peak value to memory and/or...

4. Save the second peak value to memory and/or...
5. Zero the peak readings and/or...
6. Toggle an output pin

These automatic functions can help automate and expedite testing processes. If tones are enabled, an audible tone will sound when the output, storage, and zero functions have occurred. In order for First / Second Peak detection to be active, the appropriate operating mode must be selected. See the **Operating Modes** section for details. The display appears as follows:

FIRST/SECOND PEAK
* Enabled
+ Peak Settings
+ Auto Output
* Auto Store PK1
* Auto Store PK2
* Auto Zero

Any combination of the above functions may be selected.

Function	Description
Enabled	If enabled, 2PK appears as one of the operating modes. In the main display, the Peak readings will reference the first and second peaks – first peak on top, second peak below. Refer to the Home Screen & Controls section for details.
Peak Settings	See following sub-sections for details.
Auto Output	
Auto Store PK1	Automatically stores the first peak reading to memory.
Auto Store PK2	Automatically stores the second peak reading to memory.
Auto Zero	Automatically zeroes the display following data transmission and/or storage.

9.7.2 Peak Settings

The display appears as follows:

PEAK SETTINGS	
Threshold 1:	5 %
% Drop 1:	10 %
Threshold 2:	5 %
% Drop 2:	10 %
Auto Zero Delay	3 sec.

Threshold 1	Sets the percentage of full scale at which the first/second peak detection feature becomes active. This threshold is provided to ignore peaks that can occur during sample loading and unloading. Available settings: <i>1–90%, in 1% increments between 1–5%, and in 5% increments between 5–90%.</i>
% (Percentage) Drop 1	Identifies the first peak via detection of a specified percentage drop from peak. Available settings: <i>5–95% of peak, in 5% increments.</i>
Threshold 2	Same as Threshold 1, but refers to a percentage increase above the load associated with the first peak percentage drop.
% (Percentage) Drop 2	Same as Percentage Drop 1 but for the second peak.
Auto Zero Delay	Sets the time delay before the peak readings are zeroed. Available settings: <i>1–10 sec. in 1 sec. increments, and 10–60 sec. in 5 sec. increments.</i>

Thresholds and percentage drops are illustrated below:

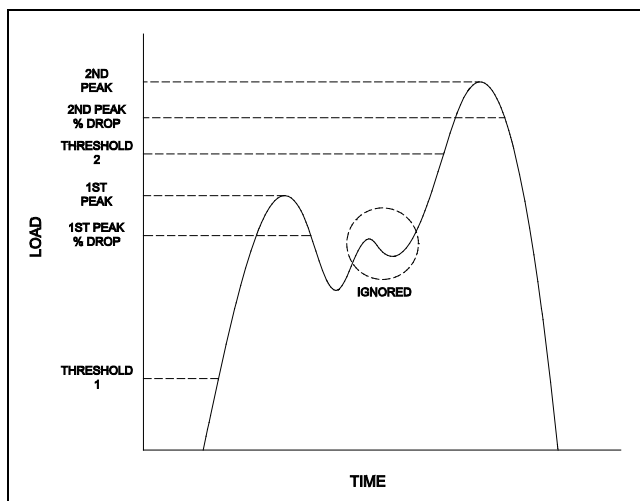

9.7.3 Auto Output Settings

Scroll to **Auto Output Settings** and press **ENTER** to select the desired automatic outputs. Select RS-232/USB and/or Mitutoyo outputs, and select First and/or Second peaks, and an Output Pin, if desired. The display appears as follows:



Parameter	Description
RS232/USB Output	Automatically output the selected peak(s) after the 2 nd peak is detected.
Mitutoyo Output	Automatically output the selected peak(s) after the 2 nd peak is detected.
First Peak	Automatically output the first peak.
Second Peak	Automatically output the second peak.
Output Pin	Automatically toggle the SP1, SP2, or SP3 pins (active low). If not required, select "NONE". To stop a Mark-10 test stand when a 1 st /2 nd peak capture sequence is completed, specify SP2 if moving in the tension/counter-clockwise direction, or SP1 for the compression/clockwise direction. Note: Because the same pins are also used for set points, the stand will stop at whichever condition occurs first.

10 DATA MEMORY AND STATISTICS

The M7I has a storage capacity of 5,000 data points. Readings may be stored, viewed, and output to an external device. Individual, or all data points may be deleted. Statistics are calculated for the data in memory.

To enable memory storage, select **DATA Key** from the menu, then scroll to **Memory Storage** and press **ENTER**. Then exit the menu. In the home screen, the data record number **0000** appears below the primary reading. Press **DATA** at any time to save the displayed reading. The record number will

increment each time **DATA** is pressed. If **DATA** is pressed when memory is full the message "MEMORY FULL" will be flashed at the bottom of the display and a double audio tone will be sounded.

To view, edit, and output stored readings and statistics, select **Memory** from the menu. The screen appears as follows:

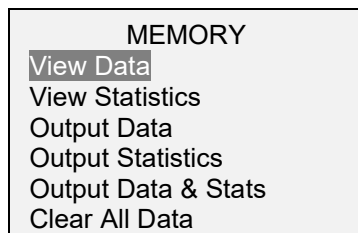

10.1 View Data

All the saved data points may be viewed. The record number is displayed, along with the corresponding value and currently set unit of measurement. Any readings may be deleted individually. To do so, scroll to the desired reading and press **DELETE**. The letter "D" appears to the left of the record number, indicating that the indicator is in **Delete** mode, as follows:

0001	2.458 lbFin
0002	2.224 lbFin
0003	2.446 lbFin
0004	1.890 lbFin
D 0005	2.098 lbFin
0006	1.998 lbFin
0007	2.042 lbFin

Press **ENTER** to delete the value. To exit **Delete** mode, press **DELETE** again. Any number of readings may be individually deleted, however, all readings may also be cleared simultaneously. Refer to the **Clear All Data** section for details.

10.2 Statistics

Statistical calculations are performed for the saved values. Calculations include number of readings, minimum, maximum, mean, and standard deviation.

10.3 Output Data

Press **ENTER** to output data to an external device. The display will show, "SENDING DATA...", then "DATA SENT". If there was a problem with communication, the display will show, "DATA NOT SENT". Saved data can be transmitted to a data collection program such as MESUR™gauge. Refer to their respective user's guides for details.

10.4 Output Statistics

Press **ENTER** to output statistics to an external device. The display will show, "SENDING STATS...", then "STATS SENT". If there was a problem with communication, the display will show, "STATS NOT SENT".

10.5 Output Data & Stats

Press **ENTER** to output data and statistics to an external device. The display will show, "SENDING DATA", then "SENDING STATS...", then "DATA SENT", then "STATS SENT". If there was a problem with communication, the display will show, "DATA NOT SENT" and/or "STATS NOT SENT".

10.6 Clear All Data

Press **ENTER** to clear all data from the memory. A prompt will be shown, "CLEAR ALL DATA?". Select **Yes** to clear all the data, or **No** to return to the sub-menu.

Shortcut for clearing all data: In the main menu, highlight **Memory** and press **DELETE**. The same prompt will be shown as above.

For output of data and/or statistics, RS-232 or USB output must be enabled. Data formatting is <CR><LF> following each value. Units can be either included or excluded. Output of data via the Mitutoyo output is possible; however, output of statistics is not. Refer to the **Communications and Outputs** section for details.

Note: Data is not retained while the indicator is powered off. However, the indicator protects against accidental or automatic power-off. If manually powering the instrument off, or if the inactivity time limit for the **Automatic Shutoff** function has been reached, the following warning message appears:

```

*** WARNING ***
DATA IN MEMORY
WILL BE LOST

  CANCEL
POWER OFF

```

If no option is selected, this screen will be displayed indefinitely, or until battery power has been depleted.

11 FOOTSWITCH

This feature allows the indicator to execute up to three functions in sequence, separated by an optional delay, when the External Trigger input (pin 14 on the I/O connector) transitions from a high level to a low level, or from a low level to a high level. The ET input has an internal pull-up resistor. One suggested method for triggering the footswitch sequence would be to provide a relay or contact closure to ground.

To enable the footswitch settings, select **Footswitch** from the menu. The display appears as follows:

```

FOOTSWITCH
Enabled
Step 1:  NONE
Delay 1:  0 sec.
Step 2:  NONE
Delay 2:  0 sec.
+ More

```

Select "+ More" for additional options:

```

FOOTSWITCH 2

Step 3:  NONE
* Active Low (NO)
Active High (NC)

```

Function	Description
Enabled	Press ENTER to enable, and an asterisk appears.
Step 1 / 2 / 3	Set the desired command. Available commands: <i>?, ?C, ?PT, ?PC, ?A, Z, CLR, PM, DATA Key, and NONE</i> . <i>DATA Key</i> simulates a press of the DATA key. Explanations for other commands may be found in the Communications and Outputs section.
Delay 1 / 2 / 3	Set the desired delay between commands. Available settings: <i>0 – 5 sec. in 1 sec. increments, and 5 – 60 in 5 sec. increments</i> .
Active Low (NO)	Normally open contact between pin and ground.
Active High (NC)	Normally closed contact between pin and ground.

12 COEFFICIENT OF FRICTION

The M7I, with an appropriate force sensor, can determine the static and kinetic coefficients of friction (COF) between two materials through the Averaging and peak tension capture functions. The process for determining COF requires dragging a block of a known mass (usually 200 g) over a surface at a constant speed. The force required to do so is divided by the weight of the block. For example, a force of 100 gF divided by 200 g equals 0.5 COF.

Although many COF testing applications require a sled weight of 200 g, the indicator allows the user to change the sled weight to comply with other requirements. To modify the sled weight, select **COF** from the menu. The display appears as follows:

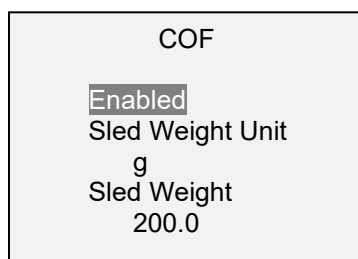

Available sled weight settings: *10% to 100% of the sensor's capacity*

Motorized test stands and suitable fixtures are recommended for COF measurement applications.

Recommended products: ESM303 test stand and G1086 COF fixture

13 CUSTOM UNIT

A user-defined unit of measurement may be configured for special applications. A base unit is specified, along with a multiplier, and 5-character name. Typical applications:

1. To measure the torque produced by pressing on a lever in a mechanical assembly, configure the multiplier based on the length of the lever, thereby converting a unit such as N into Ncm.
2. To measure the pressure produced by a circular compression plate on a foam sample, configure the multiplier based on the area of the plate, thereby converting a unit such as lbf into psi.

To access this feature, select **Custom Unit** from the menu. The display appears as follows:

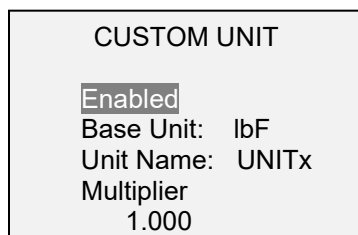

Function	Description
Enabled	Press ENTER to enable, and an asterisk appears. After exiting the menu, the custom unit appears as one of the available units.
Base Unit	Select any available standard unit.
Unit Name	Specify up to 5 alphanumeric characters, using the ▶ key to advance to the next character, and the ▲ and ▼ keys to scroll through the available characters. The character “_” refers to a space. Note: Unit names with the same abbreviations as other standard units are not allowed. If a disallowed name is entered, a warning message appears.
Multiplier	Select a value relative to the base unit. Available values: 0.001 – 1,000 Note: Lowest measured value must correspond to a resolution of at least 0.00001. Highest measured value must correspond to a maximum displayed reading of 500,000.

14 COMMUNICATIONS AND OUTPUTS

Communication with the M71 indicator is achieved through the micro USB or 15-pin serial ports located at the bottom of the instrument, as shown in the illustration in the **Power** section. Communication is possible only when the indicator is in the main operating screen (i.e. not in a menu or configuration area).

14.1 Serial / USB

To set up RS-232 and USB communication, select **Serial/USB Settings** from the menu. The screen appears as follows:

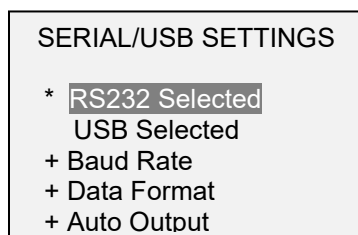

Select either RS-232 or USB input (output is always active for both the USB and RS-232 ports). RS-232 must be selected when communicating through a Mark-10 test stand controller. When communicating from the indicator directly to a PC or data collector, either RS-232 or USB can be selected as required. Press **DATA** to transmit individual data points or to commence an automatic output sequence (see **Automatic Output** sub-section for details). Single point or continuous data may also be requested via ASCII commands from an external device (see **Command Set** sub-section for details).

Communication settings are permanently set to the following:

Data Bits: 8
Stop Bits: 1
Parity: None

Other settings are configured as follows:

14.1.1 Baud Rate

Select the baud rate as required for the application. It must be set to the same value as the receiving device. When communicating with a Mark-10 test stand controller, the baud rate must be set to 115,200.

14.1.2 Data Format

Select the desired data format. The screen appears as follows:

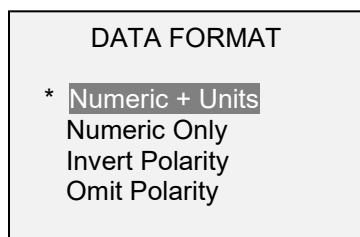

Selection	Description
Numeric + Units	Output format includes the value and unit of measure. Compression/clockwise values have positive polarity, tension/counter-clockwise values have negative polarity.
Numeric Only	Output format includes the value only. Polarity same as above.
Invert Polarity	Compression/clockwise values have negative polarity, tension/counter-clockwise values have positive polarity. May be selected in addition to the Numeric + Units / Numeric Only selection.
Omit Polarity	Both directions are formatted with positive polarity. May be selected in addition to the Numeric + Units / Numeric Only selection.

14.1.3 Automatic Output

The indicator has the ability to output data continuously via RS-232 or USB. To enable automatic output, select **Auto Output** from the **Serial/USB Settings** sub-menu. The screen appears as follows:

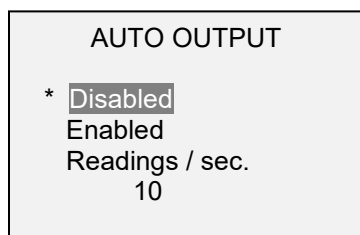

Select **Enabled** to activate automatic output. The number of readings per second can be set to 1, 2, 5, 10, 25, 50, 125, or 250. The capabilities of the receiving device should be considered when selecting the data output rate.

After the settings have been saved, revert to the home screen. An icon appears in the lower left corner of the display, as follows: This indicates that automatic data output has been armed. Automatic output of data may be initiated by pressing **DATA** or by sending the appropriate ASCII command from an external device (see **Command Set** sub-section for details). The icon will become animated, signaling that automatic output is occurring. Press **DATA** again to end the data transmission.

14.2 Mitutoyo BCD settings

This output is useful for connection to data collectors, printers, multiplexers, or any other device capable of accepting Mitutoyo (Digimatic) BCD data. Individual data points may be transmitted by pressing **DATA** or by requesting it from the Mitutoyo communication device (if available). To enable Mitutoyo output, select the desired format – either with polarity or without polarity. The screen appears as follows:



14.3 Analog Output

This output can be used for chart recorders, oscilloscopes, data acquisition systems, or any other compatible devices with analog inputs. The output produces ± 1 volt at full scale of the instrument. The polarity of the signal is positive for compression and negative for tension.

14.4 DATA Key Functions

The **DATA** key can be configured to perform several functions. To configure the **DATA** key, select **DATA Key** from the menu. The display appears as follows:

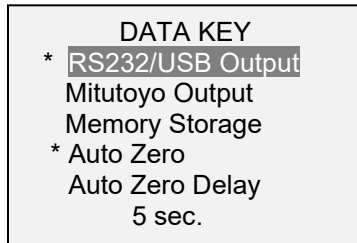

Selection	Function when pressing DATA
RS232/USB Output	Outputs data via the serial and USB ports
Mitutoyo Output	Outputs data via Mitutoyo (Digimatic)
Memory Storage	Stores a reading to memory (refer to the Memory section for details)
Auto Zero	Automatically zero the reading as if the ZERO key has been pressed after the reading is output and/or it is stored in memory.
Auto Zero Delay	The amount of time before the auto-zero occurs, in seconds: 1 – 10 seconds in 1 second increments, and 10 – 60 seconds in 5 second increments.

Any combination of the above functions may be selected.

14.5 I/O Connector Pin Diagram (DB-9HD-15 female)

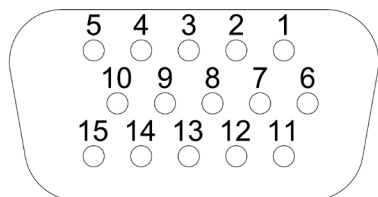

Pin No.	Description	Input / Output
1	Signal Ground	---
2 *	Tension / Counter-clockwise Overload *	Output *
3	RS-232 Receive	Input
4	RS-232 Transmit	Output
5	+12V DC	Input / Output
6	Analog Output	Output
7 *	Compression / Clockwise Overload *	Output *
8	Mitutoyo Clock or Output Bit 2 (mutually exclusive)	Output
9	Mitutoyo Data or Output Bit 0 (mutually exclusive)	Output
10	Mitutoyo Request or Input Bit 3 (mutually exclusive)	Input
11 **	Set Point Pin 1 (SP1)**	Output **
12 **	Set Point Pin 2 (SP2)**	Output **
13 **	Set Point Pin 3 (SP3)**	Output **
14	External Trigger or Footswitch (mutually exclusive)	Input
15 *	Mitutoyo Ready or Output Bit 1 (mutually exclusive) *	Output *

* Maximum voltage: 40V.

** The output assignments depend on several factors described in the table below. Output functions always reference the primary reading on the display, regardless of the current mode.

Load	Pin 11	Pin 12	Pin 13
Upper and Lower Set Points are C / CW			
Greater than or equal to upper set point	On	Off	Off
Between upper and lower set points	Off	Off	On
Less than or equal to lower set point	Off	On	Off
Upper and Lower Set Points are T / CCW			
Greater than or equal to upper set point	Off	On	Off
Between upper and lower set points	Off	Off	On
Less than or equal to lower set point	On	Off	Off
Upper Set Point is C / CW, Lower Set Point is T / CCW			
Greater than or equal to upper set point, in C / CW	Off	On	Off
Between upper and lower set points	Off	Off	On
Greater than or equal to lower set point, in T / CCW	On	Off	Off
Upper Set Point is T / CCW, Lower Set Point is C / CW			
Greater than or equal to upper set point, in T / CCW	Off	On	Off
Between upper and lower set points	Off	Off	On
Greater than or equal to lower set point, in C / CW	On	Off	Off

C = compression, T = tension, CW = clockwise, CCW = counter-clockwise

14.6 Command Set / Gauge Control Language 2 (GCL2)

The M5I indicator may be controlled by an external device through the RS-232 or USB channels. The following is a list of supported commands and their explanations. All commands must be terminated by a CR (Carriage Return) character, 0x0D, or a CR-LF (Carriage Return – Line Feed) pair, where the Line Feed, 0x0A, is ignored.

Request Readings

?	Request the displayed reading (dependent on operating mode)
?C	Request the current (real time) reading
?CW	Request the peak clockwise reading
?CCW	Request the peak counter-clockwise reading
?PT	Request the peak tension reading (corresponds to static COF)
?PC	Request the peak compression reading
?ET	Request the reading obtained during the External trigger mode
?A	Request the average reading obtained during the Average mode (corresponds to kinetic COF)
?P1	Request 1 st peak reading

Units

LB	Switch unit to pound-force
OZ	Switch unit to ounce-force
KG	Switch unit to kilogram-force
G	Switch unit to gram-force
N	Switch unit to Newton
MN	Switch unit to milli-Newton
KN	Switch unit to kilo-Newton
LBFT	Switch unit to pound-foot
LBIN	Switch unit to pound-inch
OZIN	Switch unit to ounce-inch
KGM	Switch unit to kilogram-meter
KGMM	Switch unit to kilogram-millimeter
GCM	Switch unit to gram-centimeter
NM	Switch unit to Newton-meter
NCM	Switch unit to Newton-centimeter
NMM	Switch unit to Newton-millimeter
COF	Switch units to Coefficient of Friction
CU	Switch to user-defined custom unit
COFE	Enable Coefficient of Friction unit
COFD	Disable Coefficient of Friction unit
CUE	Enable user-defined custom unit
CUD	Disable user-defined custom unit

Basic Functions (available measurement directions depend on the sensor used)

CUR	Select Current (real time) mode
PT	Select Peak Tension mode
PC	Select Peak Compression mode
PCW	Select Peak Clockwise mode
PCCW	Select Peak Counter-clockwise mode
FSPK	Select First / Second Peak mode (must first be enabled in the menu)
CAPT	Select Data Capture mode (must first be enabled in the menu)
CLR	Clear peaks
Z	Zero display and perform the CLR function

Filters

FLTPn	Digital filter for displayed readings
FLTCn	Digital filter for current readings n= 0-10, filter = 2 ⁿ , ex: n=0= no filter, n=10=1024 samples averaged

Memory & Statistics

MEM	Transmit all stored readings
STA	Transmit statistics
CLRMEM	Delete all stored readings from memory

Set Points

SPHD	Disable high set point
SPLD	Disable low set point
SPHn	High set point. n=value (+ for C/CW, - for T/CCW)
SPLn	Low set point. n=value (+ for C/CW, - for T/CCW)

USB/RS-232 Communication

FULL	USB/RS-232 transmission with units
NUM	USB/RS-232 transmission without units (only numeric values)
AOUTn	Auto-transmit n times per second n=1, 2, 5, 10, 25, 50, 125, 250. 0=disabled Note: n = 1 = yields 50 times per second. This is provided for backward compatibility with the legacy indicator model BGI.
IPOLn	Invert polarity of output. n=1=invert polarity. n=0=normal (default) Note: Normal polarity is positive for compression/CW and negative for tension/CCW.
OPOLn	Omit polarity of output. n=1=omit polarity. n=0=include polarity (default) Note: The "+" sign is always omitted. A "-" sign is sent when polarity is enabled.

Mitutoyo Communication

MIT	Enable Mitutoyo output
MITD	Disable Mitutoyo output
POL	Mitutoyo output with polarity (+ for compression, - for tension)
NPOL	Mitutoyo output without polarity (absolute value)
PM	Print/send data to a Mitutoyo-compatible device

Averaging

A	Enable Average mode
AD	Disable Average mode
AM	Select Average mode (if enabled) for primary reading
TRFn	Trigger load. n=value (+ for C/CW, - for T/CCW)
DELn	Initial delay. n=0.1-300.0 seconds
ATn	Average time. n=0.1-300.0 seconds

External Trigger

ETH	Enable high level-triggered External trigger mode
ETL	Enable low level-triggered External trigger mode
ETHL	Enable reading captured on a high to low transition
ETLH	Enable reading captured on a low to high transition
ETD	Disable External trigger mode

Input / Output Bits

Sn	Set output bit (open drain, pull to ground). n=0, 1, 2
Cn	Clear output bit. n=0, 1, 2
Rn	Read current status of output bit or level of input pin. n=0, 1, 2, 3

Personality

RN	Read product name
RM	Read model number
RV	Read firmware version number
RS	Read serial number

Other Commands

AOFFn	Auto-shutoff. n=0-30 minutes. 0=auto shutoff disabled
SAVE	Save current settings in nonvolatile memory
LIST	List current settings and status

14.7 Command Responses

In response to a reading request command (those which begin with '?') the indicator will return a string with the load data, followed by a space, then the load unit (if enabled under the **Serial/USB Settings** → **Data format** sub-menu). It will be terminated by a CR-LF pair.

Example return strings:

```
-18.78 lbFin<CR><LF> 18.78 lbFin of counter-clockwise torque
1.724 N<CR><LF> 1.724 N of compression force
```

The number of digits after the decimal point is dependent of the sensor's capacity and resolution.

By default, the minus sign (-) indicates tension / counter-clockwise, and the absence of a sign indicates compression / clockwise. However, positive / negative polarity may be inverted or omitted under the **Serial/USB Settings** → **Data Format** sub-menu.

Following is an example LIST output:

```
V1.00;LBF;CUR;FLTC8;FLTP1;AOUT00;AOFF5;FULL;IPOL0;OPOL0;MIT;POL;B0
```

All fields are separated by “;”. The first field shows the firmware version, the last field shows the remaining battery power (B0=full charge, B3=minimum power). All other fields show the status of settings and features using the same abbreviations as the commands to set them.

Any detected errors are reported back by means of the following error codes:

*10	Illegal command
*11	Not applicable
*21	Invalid specifier
*22	Value too large
*51	Command string too long (25 characters maximum)

15 CALIBRATION**15.1 Initial Physical Setup**

The sensor should be mounted vertically to a test stand or fixture rugged enough to withstand a load equal to the full capacity of the sensor. Certified deadweights, torque arms/wheels, and/or master load cells should be used, along with appropriate mounting brackets and fixtures. Caution should be taken while handling such equipment.

15.2 Calibration Procedure

The following instructions use force terminology only. Such wording is displayed only when a force sensor is being calibrated. When a torque sensor is being calibrated, the terms **COMPRESSION** and **TENSION** are replaced by **CLOCKWISE** and **COUNTER-CLOCKWISE**, respectively.

1. Select **Calibration** from the menu. The first display allows an opportunity to save the calibration date or modify a previously saved calibration date (applicable to firmware version 2.2.8 or later):



Note: For Series FS05 and Series R07 force sensors, a calibration date must be selected. The **Disabled / Enabled** selection does not appear for these sensors.

For all other sensors, enable **Calibration Date** if desired, then enter the month, day, and year. Then select **Continue**.

The display appears as follows, assuming **Calibration Date** is enabled. If disabled, the word “save” is substituted by “disable”:

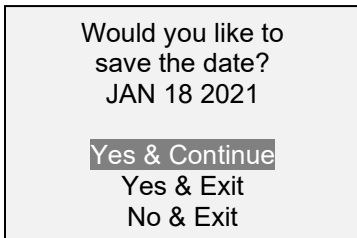

Make one of the following selections:

Selection	Description
Yes & Continue	Save (or disable) the date and continue with calibration.
Yes & Exit	Save (or disable) the date and exit the calibration menu.
No & Exit	Make no changes and exit the calibration menu.

If enabled, the calibration date will be displayed in the following instances. If disabled, the calibration date will not appear:

1. At power-up.
2. In the **Information** screen. Refer to the **Other Settings** section for further details.

The display appears as follows:

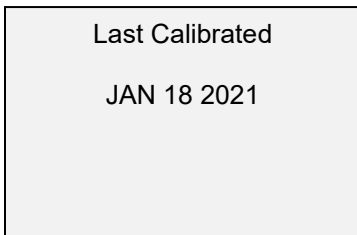



The calibration date is intended for informational purposes only. Because it may be modified independently of the actual calibration, it should not be relied upon as evidence of successful calibration.

2. If **Yes & Continue** was selected, the display appears as follows:

```
CALIBRATION
Enter # cal points
(1 to 10)
Compression:
 5
Tension:
 5
```

The sensor can be calibrated at up to 10 points in each direction. Enter the number of calibration points for each direction (compression and tension or clockwise and counter-clockwise). At least one point must be selected for each direction. For single-direction sensors such as Mark-10's Series R02, only one direction is allowed.

Note: To achieve the accuracy specification of $\pm 0.1\%$ + sensor, it is recommended to calibrate the sensor at 5 or more even increments in both the tension and compression directions. For example, a sensor with capacity of 10 lbF should be calibrated at 2, 4, 6, 8, and 10 lbF loads in each direction.

3. To escape the **Calibration** menu at any time, press **ESCAPE**. The display appears as follows:

```
CALIBRATION
NOT COMPLETE

Cancel
Exit w/o saving
```

Selecting "Cancel" will revert back to the Calibration setup. Selecting "Exit w/o saving" will return to the menu without saving changes.

4. After the number of calibration points has been entered, press **ENTER**. The display appears as follows:

```
CALIBRATION
OFFSET

Place sensor
horizontally, then
press ZERO.
```

5. Place the force sensor horizontally on a level surface free from vibration, then press **ZERO**. The indicator will calculate internal offsets, and the display appears as follows:

CALIBRATION
OFFSET

Please wait...

CALIBRATION
OFFSET

Sensor passed
Analog passed

If failed:

CALIBRATION
OFFSET

Sensor failed
Analog failed

- The following screen appears after the offsets have been calculated:

CALIBRATION
COMPRESSION

Attach necessary
weight fixtures,
then press ENTER.

Attach weight fixtures (brackets, hooks, etc), as required. Do not yet attach any weights or apply any calibration loads. Press **ENTER**.

- The display appears as follows:

CALIBRATION
COMPRESSION

Optionally exercise
sensor, then press
ENTER.

Optionally exercise the sensor several times (at full scale, if possible), then press **ENTER**.

- The display appears as follows:

CALIBRATION
COMPRESSION
Gain adjust
Apply full scale load
10.000 lbf +/-20%,
then press ENTER.

Apply a weight equal to the full scale of the instrument, then press **ENTER**.

9. After displaying "Please wait..." the display appears as follows:

CALIBRATION
COMPRESSION

Ensure no load,
then press ZERO.

Remove the load applied in Step 8, leave the fixtures in place, then press **ZERO**.

10. The display appears as follows:

CALIBRATION
COMPRESSION
Apply load
1 OF 5
Enter load:
2.000 lbF
Press ENTER.

Use the **UP** and **DOWN** keys to adjust the load value as required. The load values default to even increments, as indicated by the previously entered number of data points (even increments are recommended for best results). For example, if a 50 lbF capacity sensor is calibrated, and 5 data points were selected, the load values will default to 10, 20, 30, 40, and 50 lb. Apply the calibration load. Then press **ENTER**.

Repeat the above step for the number of data points selected.

11. After all the compression calibration points have been completed, the display appears as follows:

CALIBRATION
COMPRESSION COMPLETE
Reverse direction
for tension.
Attach necessary
weight fixtures,
then press ENTER.

Press **ENTER**.

12. At the completion of the tension calibration, the display appears as follows:

CALIBRATION
COMPLETE

Save & exit
Exit w/o saving

To save the calibration information, select "Save & exit". To exit without saving the data select "Exit without saving".

13. Any errors are reported by the following screens:

CALIBRATION
Units must be gF.
Please try again
Press ENTER.

Displayed at the start of calibration if a disallowed unit is selected.

CALIBRATION
Load not stable.
Please try again.

Ensure that the load is not swinging, oscillating, or vibrating in any manner. Then try again.

CALIBRATION
COMPRESSION
Load too low.
Please try again.

Causes:

1. The calibration weight does not match the set value.
2. If using a PTA configurable adapter, ensure that the output signal leads (SG+ and SG-) have been installed into the appropriate terminal blocks. Some sensor manufacturers consider SG+ to be a compression value, while others consider it to be a tension value. If the indicator is expecting a compression load but it is receiving a tension signal, calibration cannot continue. Verify that the tension/compression indicator on the home screen properly corresponds to the load direction, and switch the signal leads, if required.

CALIBRATION
TENSION
Load too close
to previous.
Please try again.

The entered calibration point is too close to the previous point.

16 PASSWORDS

Two separate passwords may be set to control access to the Calibration section and to the menu and other keys. To access the passwords setup screen, select **Passwords** from the menu. The display appears as follows:

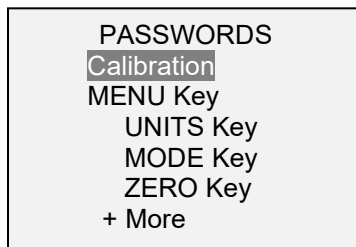

Select "+ More" for additional options:

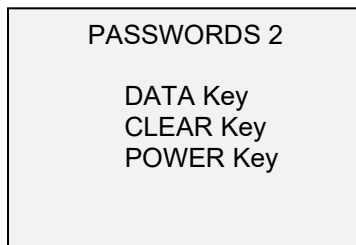

16.1 Calibration Password

Select **Calibration** from the sub-menu. The display appears as follows:



To set the password, select **Enabled**, then **Set Password**. Use the **UP** and **DOWN** keys to increment and decrement the value, from 0 to 9999. When the desired value has been selected, press **ENTER**, then **ESC** to exit the sub-menu.

16.2 MENU Key Password

If enabled, every time the **MENU** key is selected, a password must be provided. Select **Menu Key** from the sub-menu. Follow the same procedure as described above.

16.3 Locking Out Other Keys

Other keys may be locked out individually. Select any combination of keys (**UNITS**, **MODE**, **ZERO**, **DATA**) by pressing **ENTER** in the **Passwords** sub-menu. Pressing a locked key will prompt the message "KEY PROTECTED" and then revert to the previous screen.

16.4 Password Prompts

If passwords have been enabled, the following will be displayed when pressing the **MENU** key or accessing the **Calibration** section:

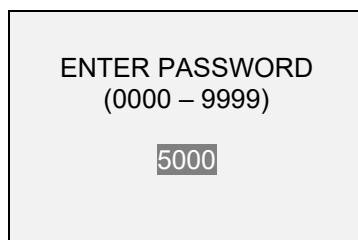

Use the **UP** and **DOWN** keys to select the correct password, then press **ENTER** to continue.

If the incorrect password has been entered, the display appears as follows:

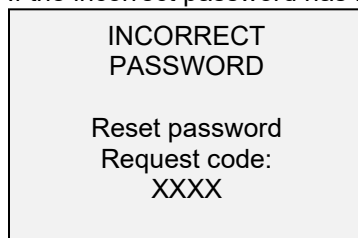

To re-enter the password, press **ESC** to exit to the home screen. Then, access the desired function and enter the password again when prompted.

If the password has been misplaced, it can be reset. Press **ENTER** to generate a *request code*. The *request code* must be supplied to Mark-10 or a distributor, who will then provide a corresponding *authorization code*. Enter the *activation code* to disable the password.

17 OTHER SETTINGS

17.1 Automatic Shutoff

The indicator may be configured to automatically power off following a period of inactivity while on battery power. Inactivity is defined as the absence of any key presses or load changes of 100 counts or less. To access these settings, select **Automatic Shutoff** from the menu. The display appears as follows:



Selection	Description
Disabled	Disable automatic shutoff.
Enabled	Enable automatic shutoff.
Set Minutes	The length of time of inactivity. Available settings: 5-30, in 5 minute increments.

Note: If the AC adapter is plugged in, the indicator will ignore these settings and remain powered on until the **POWER** key is pressed.

17.2 Backlight

Although the backlight may be turned on and off at any time by pressing the **BACKLIGHT** key, there are several available initial settings (applicable upon powering on the indicator). To access these settings, select **Backlight** from the menu. The display appears as follows:



Selection	Description
Off	Backlight to be off upon powering on the indicator.
On	Backlight to be on upon powering on the indicator.
Auto	Backlight to be on upon powering indicator, but will shut off after a period of inactivity (as defined in the Automatic Shutoff sub-section). The backlight will turn on again when activity resumes. The length of time of inactivity is programmed in minutes via the Set Minutes parameter. Available settings: 1-10, in 1 minute increments.

Note: If the AC adapter is plugged in, the indicator will ignore these settings and keep the backlight on.

17.3 LCD Contrast

The contrast of the display may be adjusted. Select **LCD Contrast** from the menu. The screen appears as follows:



Press **ENTER** to modify the contrast. Select a value from 0 to 25, 25 producing the most contrast.

17.4 Tones

Audible tones can be enabled for all key presses and alerts, such as overload, set point value reached, etc. The Set Point alert can be configured to be either a momentary tone or a continuous tone (until the load is restored to a value between the set points). To configure the functions for which audible tones will apply, select **Tones** from the menu. The screen appears as follows:

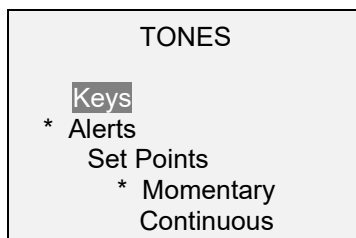

17.5 Initial settings

This section is used to configure the initial settings upon powering on the indicator. The initial units of measurement and the primary reading measurement mode may be configured. To access these settings, select **Initial Settings** from the menu. The screen appears as follows:

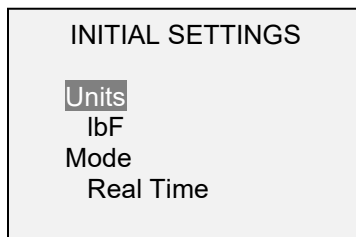

17.6 Restore Default Settings

Default factory settings can be restored by selecting **Restore Defaults** from the menu. The settings may be found in the **Specifications** section. The screen appears as follows:

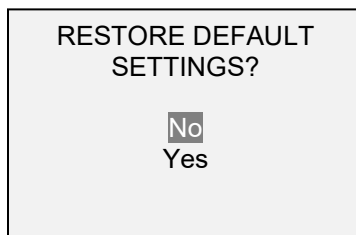

17.7 Information / Welcome Screen

The following screen is displayed at power-up and can be accessed at any time by selecting **Information** from the menu:

Digital Indicator Model MM7I Ind. SN: 1234567 Sensor: MR51-50 Sensor SN: 9876543 Version: 1.0
--

Press **Enter** again to view the previous calibration date, if enabled.

18 SPECIFICATIONS

18.1 General

Accuracy:	±0.1% of full scale + sensor
Sampling rate:	14,000 Hz
Power:	AC or rechargeable battery. Low battery indicator appears when battery level is low, and indicator powers off automatically when power reaches critical stage.
Battery life:	Backlight on: up to 7 hours of continuous use Backlight off: up to 12 hours of continuous use
Measurement units:	lbF, ozF, gF, kgF, N, kN, mN, lbFft, lbFin, ozFin, kgFm, kgFmm, gFcm, Nm, Ncm, Nmm (depending on sensor)
Outputs:	USB / RS-232: Fully configurable up to 115,200 baud. Includes GCL2 (Gauge Control Language 2) for full computer control. Mitutoyo (Digimatic): Serial BCD suitable for all Mitutoyo SPC-compatible devices. Analog: ±1 VDC, ±2% of full scale at capacity. General purpose: Three open drain outputs, one input. Set points: Three open drain lines.
Weight:	0.7 lb [0.3 kg]
Included accessories:	Carrying case, AC adapter, battery, NIST-traceable certificate of calibration
Environmental requirements:	40 - 100°F, max. 93% humidity, non-condensing
Warranty:	3 years (see individual statement for further details)
Literature & Software:	Download at: www.mark-10.com/resources

18.2 Factory Default Settings

Parameter	Setting
Set points	
Upper	Disabled (defaults to 80% of full scale, C/CW, when enabled)
Lower	Disabled (defaults to 40% of full scale, C/CW, when enabled)
Filters	
Current	16
Displayed	2048
Average mode	Disabled
Initial Delay	0
Trigger Load	10% of full scale
Averaging Time (sec.)	5.0
Auto Output Settings	All disabled

Auto Zero Delay	5 sec.
External Trigger	Disabled
Auto Output Settings	All disabled
Auto Zero Delay	5 sec.
DATA Key Functions	
RS-232/USB Output	Enabled
Mitutoyo Output	Disabled
Memory Storage	Enabled
Auto Zero	Disabled
Auto Zero Delay	5 sec.
Serial/USB	
RS-232 Output Selected	Enabled
USB Output Selected	Disabled
Baud Rate	115,200
Data Format	Numeric + Units
Auto Output	Disabled
Outputs per Sec.	125
Mitutoyo BCD Output	Disabled
Break Detection	Disabled
Threshold	10% of full scale
% Drop	50% of peak
Auto Zero Delay	5 sec.
Auto Output Settings	All disabled
Auto Storage	Disabled
Auto Zero	Disabled
First, Second Peak	Disabled
Thresholds	10%
% Drops	50%
Auto Zero Delay	5 sec.
Auto Output Settings	All disabled
Auto Store Peaks	Disabled
Data Capture	Disabled
Period	00:00:01:00000
Start Condition	Start load of 10% of full scale
Stop Condition	Stop load of 20% of full scale
Auto Settings	All disabled
Footswitch	Disabled
Steps 1 / 2 / 3	None
Delays 1 / 2 / 3	0 sec.
COF	Disabled
Sled Weight	20% of full scale
Custom Unit	Disabled
Base Unit	lbF
Multiplier	1.000
Tones	
Keys	Enabled
Alerts	Enabled
Set Points	Momentary
Automatic Shutoff	Enabled
Set Minutes	5
Backlight	Auto
Set Minutes	1
Initial Settings	
Units	Depends on sensor
Mode	Real Time
Passwords	All disabled

18.5 Dimensions (IN [MM])

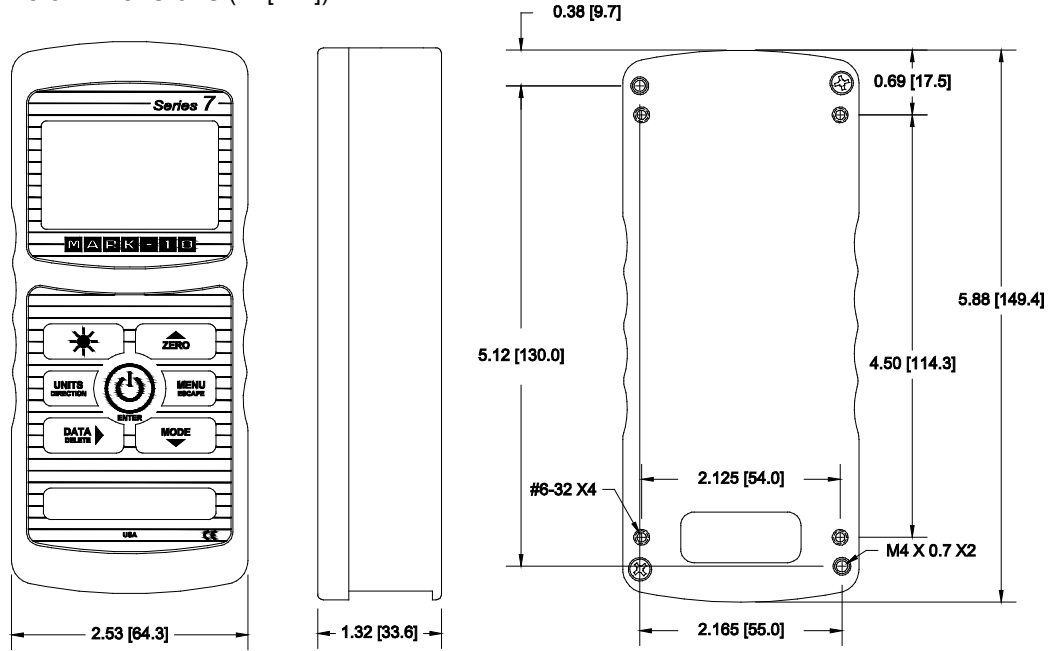

NOTES:



Mark-10 Corporation has been an innovator in the force and torque measurement fields since 1979. We strive to achieve 100% customer satisfaction through excellence in product design, manufacturing and customer support. In addition to our standard line of products we can provide modifications and custom designs for OEM applications. Our engineering team is eager to satisfy any special requirements. Please contact us for further information or suggestions for improvement.



Force and torque measurement engineered better

Mark-10 Corporation

11 Dixon Avenue
Copiague, NY 11726 USA
1-888-MARK-TEN
Tel: 631-842-9200
Fax: 631-842-9201
Internet: www.mark-10.com
E-mail: info@mark-10.com