

Digital Indicator ID-C

Inch/Metric, 1", 0,00005", Flat Back

Item number: 543-471B



Description

This is a multifunction indicator that is reliable and easy to use.

The ABSOLUTE Digimatic Indicator ID-C offers you the following benefits:

- The ABSOLUTE sensor means you don't have to carry out origin setting every time you power it on, saving you time and hassle.
- GO/±NG judgement is performed by setting the upper and lower tolerances.
- You can make simple calculations by a user-definable factor using the formula Ax (x is spindle displacement).
- Large character height of 11 mm provides good readability.
- Display 330° rotatable.
- A function lock protects the display against unauthorised use.

Specification

Range:	1"/25.4 mm
No.	543-471
Lug back plate:	
Range:	1" Inch
Digital step:	0,00005"/0,001 mm
Data output:	Yes
Max. Permissible Error (Total Range):	0,0001"/0,003 mm
Hysteresis:	0,0001"/0,002 mm
H MPE (Hysteresis):	0,0001"/0,002 mm
Mass:	190 g
Repeatability:	0,0001"/0,002 mm
Measuring force:	≤1,8 N N
Battery life:	approx. 7000 hours
Protection:	IP42
Display:	LCD, character height 11 mm rotatable 330°
Max. response speed:	Unlimited
Alarm:	Low voltage, counting value composition error, overflow error, tolerance limit setting error
Stem Ø:	8 mm
Contact point:	Carbide ball, thread M 2.5 x 0.45 mm
Power supply:	1 battery SR-44
Delivered:	Including 1 battery
ON/OFF:	Yes
ZERO/ABS:	Yes
PRESET:	Yes
Low voltage alarm:	Yes
GO/±NG judgement:	Yes

Calculation function (with formula):	Yes
Counting direction switchable:	Yes
Selectable resolution:	Yes
Digital/Analog:	Digital
Inch-Metric:	Inch/Metric
Type:	EN ISO Standard



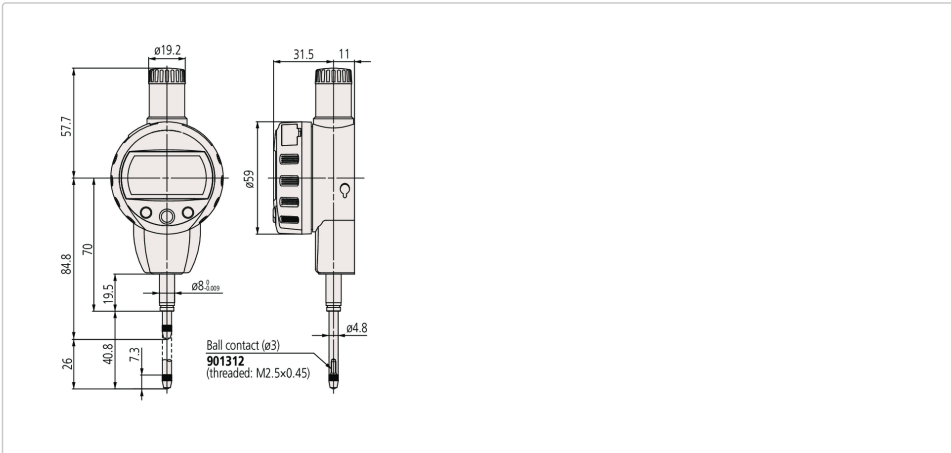



Dimensions



Accessories

Optional accessories:



	<p>Digimatic Cable, Flat Straight Type 1m 905338 List Price £40.68 inc. VAT £33.90 ex. VAT</p>
	<p>Digimatic Cable, Flat Straight Type 2m 905409 List Price £45.60 inc. VAT £38.00 ex. VAT</p>
	<p>USB Input Tool Direct (Digimatic USB) Digi/Digi2, Flat Straight Type 06AFM380F List Price £138.00 inc. VAT £115.00 ex. VAT</p>
	<p>U-WAVE-T, Buzzer Type Wireless Transmitter 02AZD880G List Price £231.60 inc. VAT £193.00 ex. VAT</p>
	<p>U-WAVE-T, IP67 Type Wireless Transmitter 02AZD730G List Price £231.60 inc. VAT £193.00 ex. VAT</p>
	<p>U-WAVE-T Connection Cable F Flat Straight Type 02AZD790F</p>



List Price

£74.40 inc. VAT

£62.00 ex. VAT



Spindle Lifting Cable

500mm

540774

List Price

24.40 ex. VAT



Spindle Lifting Cable Auto-Stop

300mm

901975

List Price

15.20 ex. VAT



Spindle Lifting Lever for 12,7mm Range

21EZA198

List Price

6.30 ex. VAT



Spindle Lifting Knob for 12,5mm, Metric

21EZA105

List Price

£16.32 inc. VAT

£13.60 ex. VAT



Spare parts

Consumable spares:



Battery SR44 1.5V

938882