

## Digital Indicator ID-C

Inch/Metric, 1", 0,0005", Flat Back

Item number: 543-475B



### Description

This is a multifunction indicator that is reliable and easy to use.

The ABSOLUTE Digimatic Indicator ID-C offers you the following benefits:

- The ABSOLUTE sensor means you don't have to carry out origin setting every time you power it on, saving you time and hassle.
- GO/±NG judgement is performed by setting the upper and lower tolerances.
- You can make simple calculations by a user-definable factor using the formula  $Ax$  ( $x$  is spindle displacement).
- Large character height of 11 mm provides good readability.
- Display 330° rotatable.
- A function lock protects the display against unauthorised use.

### Specification

Range:	1"/25.4 mm
No.	543-475
Lug back plate:	
Range:	1" Inch
Digital step:	0,0005"/0,01 mm
Data output:	Yes
Max. Permissible Error (Total Range):	0,001"/0,02 mm
Hysteresis:	0,001"/0,02 mm
H MPE (Hysteresis):	0,001"/0,02 mm
Mass:	190 g
Repeatability:	0,0005"/0,02 mm
Measuring force:	≤1,8 N N
Battery life:	approx. 7000 hours
Protection:	IP42
Display:	LCD, character height 11 mm rotatable 330°
Max. response speed:	Unlimited
Alarm:	Low voltage, counting value composition error, overflow error, tolerance limit setting error
Stem Ø:	8 mm
Contact point:	Carbide ball, thread M 2.5 x 0.45 mm
Power supply:	1 battery SR-44
Delivered:	Including 1 battery
ON/OFF:	Yes
ZERO/ABS:	Yes
PRESET:	Yes
Low voltage alarm:	Yes
GO/±NG judgement:	Yes

Calculation function (with formula):	<b>Yes</b>
Counting direction switchable:	<b>Yes</b>
Selectable resolution:	<b>Yes</b>
Digital/Analog:	<b>Digital</b>
Inch-Metric:	<b>Inch/Metric</b>
Type:	<b>EN ISO Standard</b>



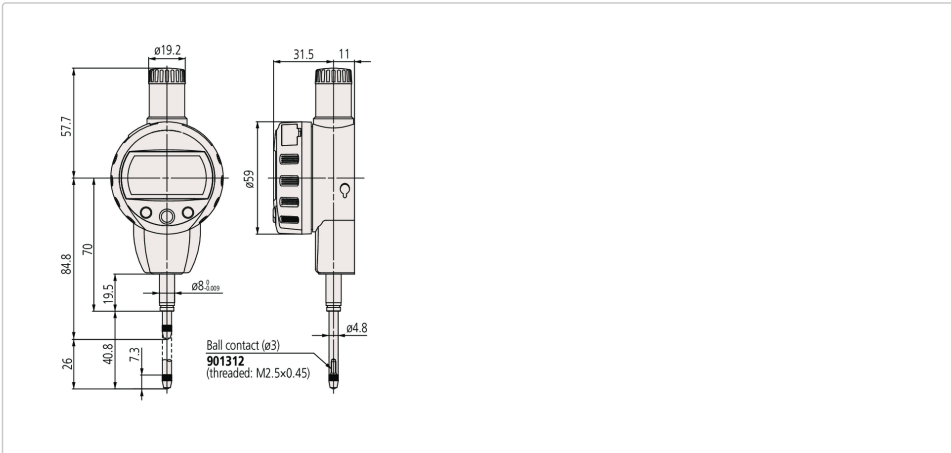



## Dimensions



## Accessories

### Optional accessories:



	<p><b>Digimatic Cable, Flat Straight Type</b>  <b>1m</b>  <b>905338</b>  List Price  <b>£40.68</b> inc. VAT  <b>£33.90</b> ex. VAT</p>
	<p><b>Digimatic Cable, Flat Straight Type</b>  <b>2m</b>  <b>905409</b>  List Price  <b>£45.60</b> inc. VAT  <b>£38.00</b> ex. VAT</p>
	<p><b>USB Input Tool Direct (Digimatic USB)</b>  <b>Digi/Digi2, Flat Straight Type</b>  <b>06AFM380F</b>  List Price  <b>£138.00</b> inc. VAT  <b>£115.00</b> ex. VAT</p>
	<p><b>U-WAVE-T, Buzzer Type</b>  <b>Wireless Transmitter</b>  <b>02AZD880G</b>  List Price  <b>£231.60</b> inc. VAT  <b>£193.00</b> ex. VAT</p>
	<p><b>U-WAVE-T, IP67 Type</b>  <b>Wireless Transmitter</b>  <b>02AZD730G</b>  List Price  <b>£231.60</b> inc. VAT  <b>£193.00</b> ex. VAT</p>
	<p><b>U-WAVE-T Connection Cable F</b>  <b>Flat Straight Type</b>  <b>02AZD790F</b></p>



List Price

**£74.40** inc. VAT

**£62.00** ex. VAT



### Spindle Lifting Cable

**500mm**

**540774**

List Price

**24.40** ex. VAT



### Spindle Lifting Cable Auto-Stop

**300mm**

**901975**

List Price

**15.20** ex. VAT



### Spindle Lifting Lever for 12,7mm Range

**21EZA198**

List Price

**6.30** ex. VAT



### Spindle Lifting Knob for 12,5mm, Metric

**21EZA105**

List Price

**£16.32** inc. VAT

**£13.60** ex. VAT



## Spare parts

### Consumable spares:



### Battery SR44 1.5V

**938882**